

**This volume was donated to LLMC
to enrich its on-line offerings and
for purposes of long-term preservation by**

Hawaii State Archives

This volume contains handwritten text that may be partially illegible due to age, penmanship, or deterioration of the medium. LLMC has scanned the material in the same format and page order in which it is maintained in the Hawaii State Archives.

Index 1810

A

2144^c Ahi
 2944^b Akoni
 5506 Ahi (Pake)
 281^b Ali
 3381^b Aihuanu
 61^{FL} Aholo
 6748 Ahapai
 3218 Ahaka
 5368 Ahaki

Page 29 718 Kapehana
 127 3685^b Kaia
 136 2142 Kawaakei
 456 1376 6449 Kapu
 376 7590 Kainokano
 408 9795 Kaunama
 452 7632 Kahookano
 571 6799 Keatia
 626 9611 Kahina
 644-2 1285 Kamakini I.
 7 277^b Kalaipaihalo
 19 525 Kahiamoe
 65 4878^b Kapua
 71 336 Kapu
 85 1001 Keaweale
 88 286 Kawa
 90 351 Kaenana
 98 9795^b Kaawa
 101 5116 Kanae Samuel
 103 6244 Katakaito
 131 2281 Kaiama S. B.
 143 11050^b Kachenui
 200 1^F Kapu
 233 8854 Kalua
 262 5057 Kuahopu
 326 68 Kapahoanui
 381 8547 Kaiwi
 394-5 2039 Kahui
 573 9822 Kaialau
 406 5047 Kalei no Kah. Chalani
 483 3378^b Kawaitiula
 518 1558 Keliuua
 520 5047 Kalei
 537 2289 Kauhola
 555 548 2287 Kukeleau motu
 615 7856 Kapali, go. P. Mimiui
 639 8004 Kapuiki
 652 8095^b Kapuiki P.
 1682 7119 Kapuiki P.
 1151 Kuewa
 8863 Kekuiahao S.

118 78^{FL} Kuaia G. D.
 75 6883 Kahana motu
 78 6869 Kawaioku
 83 9823 Kawa
 84 6873 Kahakiko
 86 6467 Kapu
 92 6875 Kaulakea
 94 1119 Kaiwa
 96 7158 Kahopii
 100 2286 Kekapai
 102 3876^b Kanae
 105 6233 Kahukaiho
 108 599 Keauiaole
 111 6256 Kaanaana
 114 4890 Kuaia no Keli Kahiliolo
 116 32^{FL} Kanae
 119 80^{FL} Kapua
 120 82^{FL} Keana
 122 83^{FL} Kahakaie
 123 87^{FL} Kanae
 125 3454 Keawe
 128 26^{FL} Kalalawala
 129 59^{FL} Kanae
 130 60^{FL} Kanae
 132 2054 Kahua no Poupou
 133 5049^b Keoti no maule
 134 3453 Kalua
 137 100^{FL} Kaula
 139 5843 Kahowaha no Kookonua
 145 6024 Kanae
 147 1124 Kahaonui
 148 403^{FL} Kamae
 153 3375^b Kaunama no Kaula
 155 3322 Kute (S. Eute) 1712 P. 458
 157 91^{FL} Kinaia no Keaukua
 158 1341 Kanae
 159 1799 Keka
 162 63^{FL} Kanae
 165 1557 Koa (no Palakiko W.)
 168 1575 Kekuiahao
 170 1599 Kukulani
 171 11174 Keatiko
 172 1089 Kapu
 173 6238 Kane
 175 8844 Kamaikahilifu
 176 71^{FL} Kahaka
 177 95^{FL} Kaula
 178 5524 Konia S.
 179 " "
 180 " "
 181 " "
 182 " "
 183 " "
 184 " "
 185 3029 Kapuiki
 186 4150 Kapu
 187 8001 Keaweale
 188 190 Kekuiahao no K. 4605
 189 1122 Kekuiahao no (1772 P. 511)
 190 7775 Kanae
 191 " "
 192 " "
 193 1174 Kapu
 194 842 Kaulaokamano
 195 7182 Kapalahaole
 196 4878^b Kanae
 197 6900 Keaweale
 198 8515 Kanae
 199 " "
 200 8515 Konia S.

H.

6715 Homanawani
 1123 Hona
 1037 Hanu
 3374^b Haka
 9809 Haka
 388 Haka
 3374^b Haka
 806 Haka
 278^b Haka
 6549 Haka
 4006 Haka
 2937 Haka
 4878^b Haka
 2253 Haka
 1279 Haka
 8075 Haka
 8179 Haka
 852^b Haka
 8146 Haka
 3237 Haka
 698 Haka
 6716 Haka
 991 Haka
 11041 Haka
 8207 Haka
 2715 Haka
 6545 Haka
 5382 Haka

7 7
 19 19
 65 65
 71 71
 85 85
 88 88
 90 90
 98 98
 101 101
 103 103
 131 131
 143 143
 200 200
 233 233
 262 262
 326 326
 381 381
 394-5 394-5
 573 573
 406 406
 483 483
 518 518
 520 520
 537 537
 555 555
 615 615
 639 639
 652 652

194
 194
 203
 204
 205
 216
 208
 209
 211
 212
 213
 214
 215
 216
 217
 218
 219
 220
 221
 222
 223
 225
 226
 228
 229
 230
 231
 232
 233
 235
 238
 239
 240
 241
 242
 244
 247
 249
 250
 256
 257
 260
 261
 265
 266
 267
 270
 271
 272
 273
 274
 275
 276
 277
 278
 283
 285
 289
 290
 291
 292
 293
 295
 296
 297
 298

I.

1074 I.
 1160 I. no Kaha
 8241 I. John

160
 413
 637-629 476

162
 165
 168
 169
 170
 171
 172
 173
 175
 176
 177
 179
 180
 182
 184
 185
 186
 187
 188
 189
 190
 191
 192

K.

933 Kanae
 8520 Kanae
 2003 Kanae
 7880 Kanae
 5573 Kanae
 1156 Kanae
 772 Kanae
 96 Kanae
 9003 Kanae
 2072 Kanae
 2029 Kanae
 5834-388 Kanae
 5006 Kanae
 10605 Kanae
 5873 Kanae

2
 3
 7
 8
 14
 16
 18
 22
 23
 25
 26
 31
 37
 44
 53
 56-57
 59
 64
 66

166
 168
 169
 170
 171
 172
 173
 175
 176
 177
 179
 180
 182
 184
 185
 186
 187
 188
 189
 190
 191
 192

L.

1074 L.
 30 L. Kanae

160
 413

162
 165
 168
 169
 170
 171
 172
 173
 175
 176
 177
 179
 180
 182
 184
 185
 186
 187
 188
 189
 190
 191
 192

8322	Kamatena no Kaia	305	727	Kanane P.	419	6236	Kaiaawaawa	588
8525 ^B	Kauwa Julia Alapai	307-8-9	7130	Kinimaka	421-2	7587	Kealoha no Keameiwi	571
79 ^{FL}	Kekuanui	311	8305	Kanoa P.	422	6247	Kanaulu Page 628	615
285	Kamakini	313	1718	Kielaue	428	8466	Kapapa	578
7777	Kaicino	314	1140	Kaiwikula	429	6175	Kamaha	580
7715	Kamehameha Lota 621.23	316	74 ^{FL}	Kakanai	"	302	Kuakini J.A.	584
7953	Kahikona	318	73 ^{FL}	Kauahiki	430	303.4.5.1.7	636 Kuakamauna E.	588
667	Kauaia	319	7763	Kamamalu V. 617-18.19	432	6209	Kamo-hai	589
7127	Kahoochanohana	321	"	" - to 462-3-5 6450	8635	Kalawela J. Tate	590	
5524	Kouia C	321	8603	Kanaiu	442	2777	Kaino P. Malule no Kalola	602
8645	Kepu	323	1695	Kamitimili (See N.)	444	234 ^B	Kauaui no Kapahukula	604
45 ^{FL}	Kawiliko	324	64 ^{FL}	Kaputani	452	10806	Kamehameha 3 (P. Nuuanu 653)	607-8
5743	Kapahi	326	2379	Kaiwinui	454	5240-5264	Kalama P. Makooko-o	605
5575	Kapuaipoopo	327	8568	Kalucinanea	455	7714 ^B	Kekuaniwa M.	620
7152	Kiniakua	328	7122	Kuke S. (Tute) 12222	458	7716	Keelitolani P.	623
5046 ^B	Kauwai no K. Kalawia	329	11228	Kuinoino	461	5524	Kouia C.	628
66 ^{FL}	Kamaala	333	7762	Kinualii	463	7712	58516 ^B Kekuanaoa P. Kamaitui	629
84 ^{FL}	Kaahiki	334	8522 ^B	Kate	465	7588	Kamoonohu	"
7765	Kane Kapaui	336	7758	Kamiona	466	7588 ^B	Kakaimanahu	630
4290 ^B	Kuauwa	337	4452	Kalama 1859-546-473.597-467.672	472	5235	Kapuiti	632
2588	Kaahewahewa	340	8515	Keoni Ana	493-5	5463	Kahonu	636
38 ^{FL}	Kekumupala	342	1375	Kapuli	497	6230	Kuakini J.A.	640
8548	Kaakea	344	6239	Kakaimoku	"-8	130	Kekuaupani	642
1499	Kapahu	346	247	Kanaina fu Sunalilo 573-698-523.6-577-601				643
3173	Kealoha	347	4215	Kealikouui A. 500-499	502	7588	Kamoonohu	"
77 ^{FL}	Katalilo	351	7181	K. Kekai	504	6489	Kaihiwa	645
3169	Koalele	352	4878 ^B	Kahulani	"	9150	Kupa	"
463	Kuikelani no Kuhuakamahalua 253	353	7682	Kuluwaimakalani	505	7124	Kamaitkaaloa	648
1810	Kealoha no Kaulua	"	1037	Keawe	506	6386	Kauhao	"
6862	Kaumiumi	356	395	Katikona W.	507	5010	Kahaha	648
2812	Kamano no O. Iliolani W.	357	312	Keaweiki S.	508	8441	48534 Kapea G. L.	652
7779	Kalekiki	362	5207 ^B	Kalupaihala P.	509	7582	Kipa E.	654
3049	Kaluaokamano (See 655)	365	410	Kaanaana	510	8308	Kekaha	"
3379 ^B	Kakau	367	11144 ^B	Keaka	513	7755	Kaluaokamano	655
3380 ^B	Kelikehena	368	8603	Kanaiu	514	6489	Kaihiwa	658
7598	Kaihipaa	369	327	Kauuwai Z.	515	7117-7565	Kala	660
495	Kauakuluaa	371	812	Kao S.A.	516			
493	Kalalaka	375	1077	Keaweopu	519	1700	Liaikilani	"
2289	Kauhola	376	345 ^B	Kaawa	"	8520 ^B	Lahilahi Pini (8575 Page 46, Keoni Ana 5-6)	12
5483	Kao S.	377	9549	Kaholomoku	522	3812	Luike	13
25 ^{FL}	Kukui	382	4320	Kana	523	1985	Lippi	76
6890	Kaiwikokoote	383	5250	Kanui	526	1049	Lawaia	109
8323	Kalaukukino	384	9019	Kamann Maria	528	2546	Pipi	103
6910	Kanealoha	385	703	Kealakai	529	581	Laabuli P.	361
5580	Kaonani no P. Kaapuihi	386	6247	Kanaulu	530	373	"	128
811	Kenaku	388	11293	Kaiama Inaka	531	3272	Leiki	111
2116	Kumukaa	389	8518 ^B	Kanehoa James Young	532	9925	Lonoaea	227
9017	Kalou	390	8515 ^B	Kavanacha	"	56 ^{FL}	Lolo	246
1585	Kalua	391	6478	Kapalohu	533	2262	Luan	294
8516 ^B	Kamaitui	393-4	4457	Koloa Ana	535	9583 ^B	Liu kua	306
90 ^{FL}	Keawolu	398	65 ^{FL}	Kawelo	536	7715	Lota Kamehameha	341
724	Kalawaiarui	"	7147	Kahelo	537	996	Lau	345
6265	Kalaeoketoi no Kollina	399	357	Kaoo M.	539	278	Laanni E.	421
9524	Kaupena no Kawaha	402	8559	Kanaina C. 632.6.6	539	4801	"	363
498	Keliohoioia	403	"	" fu Sunalilo	"	33 ^{FL}	Lila	373
6245	Kalaeoketoi no Kapihini a Ukalimoa 405	406	8800	Kukuiki	540	494	Lono	522
"	"	406	5320	Kao A.	542	8581 ^B	Sunalilo W.	528
3540	Kaumihau	408	649	Kaiolo	545	708	Lahaina	549
11224	Kalalau	401	4452	Kalama K. see above	546	278	Laanni G.	617
8452	Keohokalole A. 431.2 422.67 462	414	2440 ^B	Kauaia	559	9971	Peleiohoku 586. 592 to 600. 609. 617	643
			3691 ^B	Kauhi	560	7228	Poe	
			6610	Kekoi P. Ricie no P. Oki	561			
			105 ^{FL}	Keawipuaa	562			

M.

10167	Malaetia	21
3762-5410	Mato D.	3568 725
309	Do	379
6211	Maimai	378
6218	Mauae W	341
1114	Makanoenoe	69
2833	Mahoe	74
4750	Mu	115
2944	Manini P. 7.	126
556	Makalawelawe	135
10276	Makina	141
2774	Maeino	178
7974	Mahoe Kuli	185
10218-21	Makanihi	221
11033	Mauanahia S. Shaw	257
1663	Mali	255
1673	Malulu	258
1668	Makaaui	259
5374	Mahoe	288
6660-10182	Molena	230
3154	Makaioulu	238
1035	Maa	242
4747 B	Malaetia	245
4878 B	Malaetiahana	256-603
356	Moehauna	269
4878 E	Makaiole	286
652	Mahana	292
10219	Mauae	404
1398	Mumuku	420
8018	Mela Aika	234
2777	Makule S. Kaino no Kalola	632
8830	Makakihau	657

N.

3147	Nadi	15
2570	"	20
3149	Namohiika	24
6853	Nuhi	43
1155	Naumete	54
1494	Nataupaka	67
16534	Nailili	112
4878 G	Noopala no Kapiti	140
1120	Namaka	163
3674	Nakilaku	183
824 B	N. e. au	185
3943	Nihonni	210
774	Namaile	234
63	Namaau	236
10474	"	624
1404	Nakuina	243
10512	Nakuina	263
1325	Nakea	247
1362	Nakolowaa no Hoa	264
5074	Namai	267
298	Namatika D.	278
7260 B	"	55062
7767	Nawahalaau	288
6784	Nadi	315
6730	Naeola	339-348
1072	Nawan	343
9813	Namaka	396
151	Nauoo	410
1695	Namitimili	444
7260	Namakaha B.	500
1054	Naike	517
6735	Napala	522
10463	Napela	560
10535	Napahi	576
1403	Nawahinehua	591
10184	Namahana	627
10498	Nahinu	650
6732	Nauanu S. Kamahameha	653

P.

Puaalepa	11
2024 Peale	17
1504 Pahiha	27
5911 Pale no Kapohaku	28
6711 Peuti	42
5936 Peuti	632
10605 Pikihi Sona	45.46.48.50.51
" " Kamakee	149-53.173
1553 Puunui	55
730 Punalua	70
709 Pehu	73
4678 Piwa	79
3695 B Peali	80
2145 Pouhiwa	89
333 B Pupuka no Hana	93
2626 Papa	97
315 Pahia	312-106
502 Pupuka	107
3419 B Pupule	110
6714 Puuone no Iketaulaao	146
7239 Punini	156
7074 Pale	193
7874 Panchu	"
6867 Paepoe	202
6295 Pakala	207
10802 Pautunui	228
2154 Poupou (Kahui)	229
1131 Pailani	230
94 T4 Pakaona no Kasha W.	245
1314 Puahika	253
3848 Pakalahua	282
10613 Pahi A.	285.330-492-6247
300 " "	584
11213 Puaa no A. Pahi	287
10667 Pitandele	457-286
6802 Pelehi	296
8524 B Peki	309-10
2074 Palua S. M. D.	325
10831 Puniwai	354
3846 " "	355
3834-7224 Pahi	359-60-1
6921 Paikaualani	364
10644 Piko	366
496 Pofolo	370
2622 Puupuu	372
6870 Pupule	374
5931 Pehu	381
6867 Paepoe	383
4878 B Pupuka	396
6571 Pupuka	407
8524 B Peki	416
6974 Paakahi	453
5930 Puhakua	466
1153 Pahi	526
1405 Pihilitii	558
6605 Paie S. Ketai (6610)	561
ms Pahi	562
8774 Pupaa	563
4677 Puaaiki	567
2983 Pakohana	583
4662 Paaluhii	585
4874 Polihukua	640
4675 Poha	82
6801 Opunui	412
1706 Ohu	565
376 B Poha	

11029	Anderson Iki	9
11033	Shaw P. Maunahua	237
5365	Stevens W.	540
<u>U.</u>		
500	Ukikihi	95
1087	Uluoa	99
1075	Umi	164
6792	Umi	196
6934	Ukiki no Kaikaeakoi	198
1042	Umana	332
7274	Ukukuku	379
7680	Uluuheihei	529
3141	Ukulae	64
<u>Y.</u>		
8519 B	Young Fanny	301-630

- 1700 *Pipturus* *Latin* Page 1
- 392 *Pitu* *Wairiki* *188*
- 6252 *Tekuhakilo* *Maalawai* " 152
- 1067 *Pikauke* *Kona* *Hawaii* " 145
- 8559 *Chamaena* *Kona* *Hawaii* " 135
- 9971 *Seleioholu* *Kona* *Hawaii* " 609
- 1037 *Manunu* *Koe* " 65

2327 *Parenaba* D. 124
2065 *Polabola* *Keo ni Kawaii* 170

Heleu 1700 Liaikutani

Ua hui mai oia no kona wahi ma Kalii, Honolulu ma ka Moku o
 Oahu; no ka mea, ua loa ia i ka wahi no Puuhiki mai, mai ka M. A. 1834. mai; a
 wahi ma ka i hooaapaa maia me Umickalani ke kaunahine o Puuhiki. Aka, ua nui ma
 i Liaikutani ma ka wahi no ma makahihi ke Umickalani, a ua nui keakea oia
 a hiki i ka maanawa.

Oia ka maunahi e hooia nei no Liaikutani, he hooia hui kona ma alala o ke
 Ana e uku mai oia i ke ke kupaia hapaha; alaila ua kupaia ia ia ka Palapala oia.

Pono nae ia ia ke uku no ka hooia hui a ma ka hooia ma i ka olelo. Poni;

- W. L. Lee No ka pumi a me ke kupaia i ka olelo ma ka kupaia
- G. M. Robertson No ke kupaia i ka olelo kuma 1/2 Aava
- W. L. Lee No ka palapala hui
- W. L. Lee No ka huna ana i ka la 22. October 1849
- W. L. Lee No ke kupaia i ma olelo a na hooia 1/2 Aava
- W. L. Lee No ke ana ana i ka la 29 Iulai 1852. (Ukuia #3.)
- Joanasi No ke kupaia
- Joanasi No ka hooia hui i ka olelo Augate 11, 1852

1
1
3
6

Eia na palena Anaia e S. P. Kalama

Pahale a me Eia kupaia ma Kalii, Honolulu, Oahu.
 E hooia ma ke kupaia Anaia o ka Pahale Pale pili ana me ma kupaia i ma
 Kalama a me Kalama hooia, ke kupaia Anaia o ka Anaia. A e hooia Anaia 54 Hiki. 93 Panku ma ka
 hooia hooia a hiki i pahale hooia; a Anaia 11 Hiki. 110 Panku hooia a hiki i ka hooia hooia
 lonaia H ma ka hooia hooia, a Anaia 25 Hiki. 131 Panku ma ka hooia hooia i ke hooia hooia i ma ka
 hooia hooia o ka hooia o ka Anaia o M. Kekuanana a hiki i ka hooia hooia o ka hooia hooia oia
 ana ia ma ma a me ke Umickalani a me M. Kekuanana. Alaila Anaia 59 1/2 Hiki. 2 Hooia o
 hooia ma ka hooia; a Anaia 1 Hiki. 64 Panku ma ka hooia hooia a hiki i ka hooia hooia o
 hooia. Alaila Anaia 65 1/4 Hiki. 64 Panku a hiki i ma hooia hooia ma ke Anaia hooia, a Anaia 3
 Hiki. 11 Panku pili ana me ke Kalama hooia a hiki i ka hooia hooia i ma ka hooia hooia.

Maheke o ka Anaia 3/8 Eka.



Hele 933 Kamae

Ua kii mai eia no kana man wahi ma Keiini & Teleg, Honolulu ma ka
 Moku o Cahu; no ka mea, ua hoo ia i ka hooia mau wahi no Taarao Kama wahi ma
 ka Apana 142. manna loa; a no ka aia i ka hooia mau wahi no Taarao Kama wahi ma
 hiki 1844, a ua nahi keatea oleia a hiki i keia manawa.

Eia ka makou e hooke nei no Kamae, he kuleana hoi kama, malalo o ke Aho
 Alodio. Ima e uku mai eia i ke ke Aupuni Kapaha; alaila, ua kupaia ia ia ka
 Palapala Sila Alodio.

Pono nae ia i ka uku no ka hookelele a au ka hookelele ana i ka olelo. Pono

		\$	Ken.
W. L. Lee	No ka uku a ma ke fai ana i ka olelo ma ka Moku o Cahu		
G. M. Robertson	No ke kope ana i ka olelo kiina 1/2 Aao.	50	
	No ka palapala hii.	50	
J. H. Smith	No ka hana ana i ka la 5 Aperila 1848.	1	
	No ke kope ana i ma olelo a nahi i ke 1/2 Aao	1	
J. H. Kaula	No ke ana ana i ka la 3 October 1851.	3	
Loane Li	No ke kope ana	50	
	No ka hookelele ana i ka olelo Augate 10, 1852.	250	
		250	
		10	

Eia ma palena. Anaa e H. F. Turner

Apana 1. Aina Sula ma Keiini. E hoomaka ana ma ke kahi Kama, a e holo
 Ak. 49 No. 183 pautu e fili ana i ke Alama Aupuni; Ak. 23 Kei. 227 pautu e fili ana i ke
 Keoni Ana; Ak. 50 Kei. 35 pautu e fili ana i ke Keoni Ana; Kei. 37 Kei. 250 pautu e fili ana
 i ke Keoni Ana; Kei. 40 No. 197 pautu e fili ana i ke Keoni Ana i ke kahi Maa.
 1/2 Eka.

500
 1275
 180

 240

 2195

Apana 2. A Lora ma Keiini. E hoomaka ana ma ke kahi Akau, a e holo
 Kei. 40 Kei. 134 pautu e fili ana i ke Kei. 52; No. 106 pautu e fili ana i ke
 Keoni Ana; Ak. 30 No. 151 pautu e fili ana i ke Keoni Ana; Ak. 66 Kei. 83 pautu e fili
 ana i ke Keoni Ana i ke kahi Maa.
 0. 1275 Eka.

Apana 3. A Lora ma Keiini. E hoomaka ana ma ke kahi Akau, a e holo
 Kei. 38 No. 84 pautu e fili ana i ka ana; Kei. 60 No. 129 pautu e fili ana i ke Ana;
 Ak. 42 No. 63 pautu e fili ana i ka Ana; Kei. 55 No. 93 pautu e fili ana i ke Ana;
 Ak. 40 No. 60 pautu e fili ana i ke Kei. 67 Kei. 290 pautu e fili ana i ke Kei.
 hoi i ke kahi ana.
 13/100 Eka

Apana 4. A hali ma Teleg. E hoomaka ana ma ke kahi Kama, a e holo
 Ak. 25 No. 145 pautu e fili ana i ke Kei. 60 No. 159 pautu e fili ana i ke Kei.
 Kei. 16 Kei. 60 pautu e fili ana i ke Kei. 58 Kei. 90 pautu e fili ana i ke Kei.
 Kei. 58 No. 204 pautu e fili ana i ke Kei. hoi i ke kahi ana.
 24/100 Eka

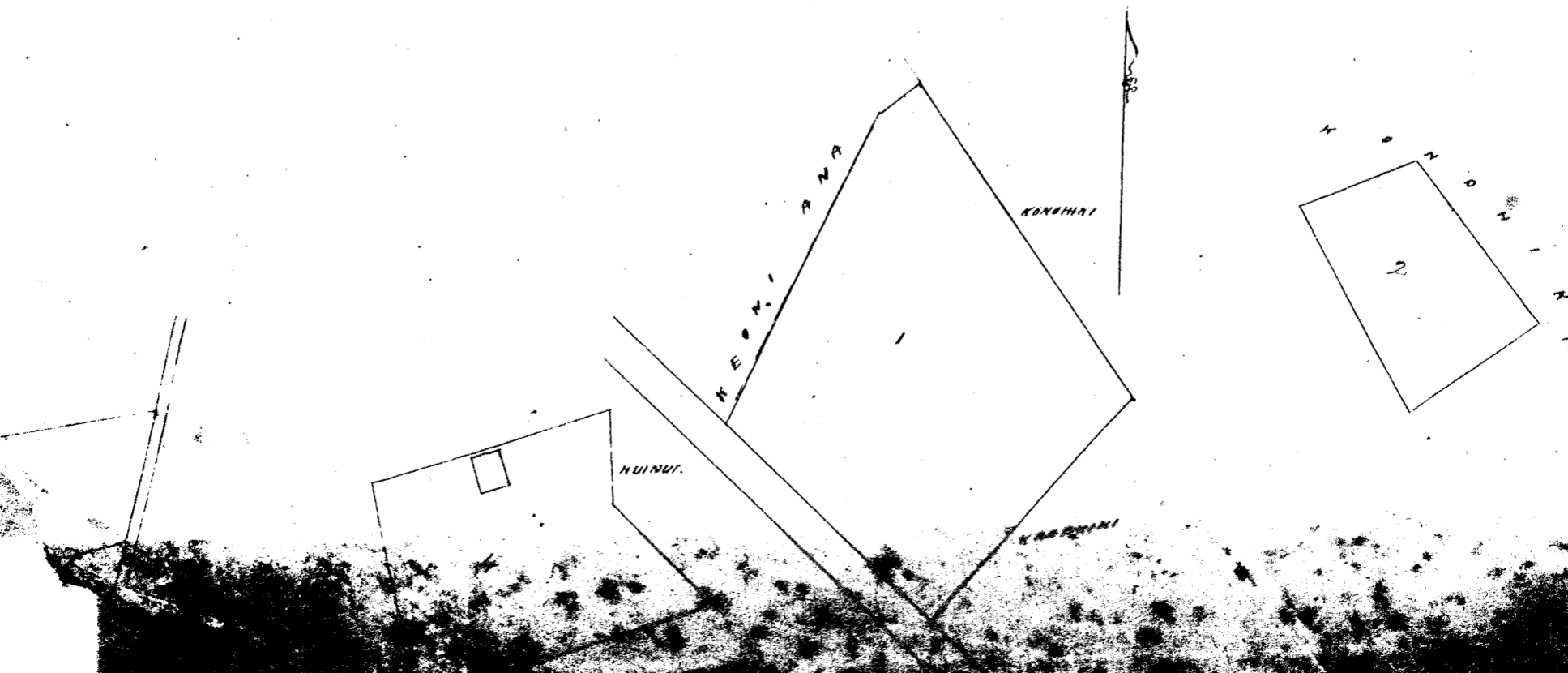

Helu 8520 Josua Kaco 3

Apana 4.

Ua hoi mai oia no kona wahi o "Kealia" he ahupuaa ia ma Lanai, no ka mea ua loa ia ia keia wahi no ke Alii Kamehameha III mai i ka Mahalo aia ana i ka M.H. 1848, a ua noho keakea oleia a hiki i keia manawa.

Oia ka makou e hooke nei no Josua Kaco, he kuleana hoi kona malalo o ke Alii Kamehameha III. Ima e uku mai oia i ke Alii Kamehameha III, alaila, ua kupuni ia ia ka Palapala Sila Alii Kamehameha III ma Kuleana o ma Kanaka maloko.

Pono nae ia ia ke uku no ka hookekoko a me ke hookekoko ana i ka olelo. Penae, § 3.

- W. L. Lee No ka nuni a me ke fua ana i ka olelo ma ka Napuepa
- G. M. Robertson No ke kope ana i ka olelo koina 1 Palani
- J. H. Smith No ka palapala kii.
- No ka hana ana i ka la
- No ke kope ana i ma olelo a ma hooke
- No ke ana ana i ka la
- J. Kakauihewa No ke kope ana
- Loane Li No ka hookekoko ana i ka olelo Argate 10, 1852. Pauloa. § 3.

Ua hooke aku makou i keia kuleana mamuli o ma olelo o ke Kanawai hou i hookekoko i ka la 19 o Iune M.H. 1852. e fua ana i ma "Konohiki".

Helu 8520 Josua Kaco

Apana 2. 3.

Ua hoi mai oia no kona man wahi, o Pua & Kalakoa, he man Ahupuaa ma Lanai ma ka Mokupuni o Maui; no ka mea, ua loa ia ia keia man wahi no ke Alii Kamehameha III mai i ka Mahalo aia ana i ka M.H. 1848, a ua noho keakea oleia a hiki i keia manawa.

Oia ka makou e hooke nei no Josua Kaco, he kuleana hoi kona malalo o ke Alii Kamehameha III. Ima e uku mai oia i ke Alii Kamehameha III, alaila, ua kupuni ia ia ka Palapala Sila Alii Kamehameha III ma Kuleana o ma Kanaka maloko.

Pono nae ia ia ke uku no ka hookekoko a me ke hookekoko ana i ka olelo. Penae, § 3.

- W. L. Lee No ka nuni a me ke fua ana i ka olelo ma ka Napuepa
- G. M. Robertson No ke kope ana i ka olelo koina 2 Palani
- J. H. Smith No ka palapala kii
- No ka hana ana i ka la
- No ke kope ana i ma olelo a ma hooke
- No ke ana ana i ka la
- No ke kope ana
- Loane Li No ka hookekoko ana i ka olelo Argate 10, 1852. Pauloa. § 3.

Ua hooke aku makou i keia kuleana mamuli o ma olelo o ke Kanawai hou i hookekoko i ka la 19 o Iune M.H. 1852. e fua ana i ma "Konohiki".

Helu 8520 Josua Kaco

Apana 5.

Ua hoi mai oia no kona wahi ma Lanai, he Ahupuaa ma Kalo ma o Kawaii; no ka mea, ua loa ia ia keia wahi no ke Alii Kamehameha III, alaila, ua kupuni ia ia ka Palapala Sila Alii Kamehameha III ma Kuleana o ma Kanaka maloko.

Oia ka makou e hooke nei no Josua Kaco, he kuleana hoi kona malalo o ke Alii Kamehameha III. Ima e uku mai oia i ke Alii Kamehameha III, alaila, ua kupuni ia ia ka Palapala Sila Alii Kamehameha III ma Kuleana o ma Kanaka maloko.

No. ke kope ana.
No ka hoholo ana i ka olelo Augati 11, 1852.

Loaudi

Pau loa.

\$ 5

Ua hooke aku makou i keia kuleana mamuli o na olelo o ke Kanawai hono i hoholoia i ka la 19 o Iune M.H. 1852. e pili ana i na "Kouhiki."

Kulu 8520B Gini Lahilahi

Ua hoi mai oia no kona wahi ma Niihau, he Ahupuaa ma Kohala Hawaii ma ka Moku o Hawaii; no ka mea, ua loa ia ia keia wahi no ke Alii Kamehameha III mai i ka Mahalo ana ana i ka M.H. 1848, a ua puhi keakea oleia a hiki i keia manawa.

Oia ka makou e hooke nei no Gini Lahilahi, he kuleana hoi kona malalo o ke Ano Alodio. Ina e uku mai oia i ke ke Ahupuaa hapaha, alaila, ua kupaia ia ia ka Palapala Sila Alodio. Koe nae na kuleana o na Kanaka anoleko.

Pono nae ia ia ke uku no ka hoholo ana a me ka hoholo ana i ka olelo. Poni,

- W. L. Lee No ka omu a me ke fai ana i ka olelo ma ka Muepa.
- G. M. Robertson No ke kope ana i ka olelo koina. Palani
- J. H. Smith No ka palapala kii
- J. H. Smith No ka hana ana i ka la
- J. H. Smith No ke kope ana i na olelo a na hoike
- J. H. Smith No ke ana ana i ka la
- J. H. Smith No ke kope ana
- Loaudi No ka hoholo ana i ka olelo Augati 11, 1852.

Pau loa

\$ 5

Ua hooke aku makou i keia kuleana mamuli o na olelo o ke Kanawai hono i hoholoia i ka la 19 o Iune M.H. 1852. e pili ana i na "Kouhiki."

Kulu 8520B Gini Lahilahi

Ua hoi mai oia no kona wahi ma Niihau, he Ahupuaa ma Kohala ma ka Moku o Hawaii; no ka mea, ua loa ia ia keia wahi no ke Alii Kamehameha III mai i ka Mahalo ana ana i ka M.H. 1848, a ua puhi keakea oleia a hiki i keia manawa.

Oia ka makou e hooke nei no Gini Lahilahi, he kuleana hoi kona malalo o ke Ano Alodio. Ina e uku mai oia i ke ke Ahupuaa hapaha, alaila, ua kupaia ia ia ka Palapala Sila Alodio. Koe nae na kuleana o na Kanaka anoleko.

Pono nae ia ia ke uku no ka hoholo ana a me ka hoholo ana i ka olelo. Poni,

- W. L. Lee No ka omu a me ke fai ana i ka olelo ma ka Muepa.
- G. M. Robertson No ke kope ana i ka olelo koina. Palani
- J. H. Smith No ka palapala kii
- J. H. Smith No ka hana ana i ka la
- J. H. Smith No ke kope ana i na olelo a na hoike
- J. H. Smith No ke ana ana i ka la
- J. H. Smith No ke kope ana
- Loaudi No ka hoholo ana i ka olelo Augati 11, 1852.

Pau loa

\$ 5

Ua hooke aku makou i keia kuleana mamuli o na olelo o ke Kanawai hono i hoholoia i ka la 19 o Iune M.H. 1852. e pili ana i na "Kouhiki."

Hele 675 Hoomanawanui

Ua hoi mai oia no kona wahi ma Keauhou, he Ahupuaa ma Koumala ana ka Moku o Maui; no ka mea, ua hooia ia i ka wahi no ke Alii Kamehameha mai i ka Matu oina ana i ka M.H. 1848, a ua noho keakea oia a hiki i keia manawa.

Oia ka maku e hooke nei no Hoomanawanui, he kuleana hoi kona malalo o ke Ano Aledia. Iua e uku mai oia i ke ke Aupuni hapaha; alaila, ua kufono ia ia ka Palapala Lilo Aledia. Koe nae ma kuleana o na Kanaka maliko.

Pono nae ia ia ke uku no ka hookekele a me ka hookele ana i ka olelo. Penei:

- W. L. Lee No ka sumi a me ke pai ana i ka olelo ma ka Aupuni.
- G. M. Robertson No ke kope ana i ka olelo kiina 13 Awar.
- St. Smith No ka hana ana i ka la
- No ke kope ana i na olelo a ma hoi ke
- No ke ana ana i ka la
- I. Kekaulahe No ke kope ana
- Loani Li No ka hookele ana i ka olelo Augate 11, 1852.

Pau loa

10

Ua hooke aku maku i keia kuleana marumaru ma olelo o ke Kanawai hou i hoo hooia i ka la 19 Iune M.H. 1852, e pili ana i na "Konoiki".

Hele 2103 Kaihuma (no H. B. Kahakualii)

Ua hoi mai oia no kona wahi ma Kahawali, ma Kouhulu ma ka Moku o Oahu; no ka mea, ua hooia ia i keia wahi no Kaawalema ~~ma ka M.H. 1831~~ 1831, a ua noho keakea oia a hiki i keia manawa.

Oia ka maku e hooke aku nei no Kaihuma, he kuleana hoi kona malalo o ke Ano Aledia. Iua e uku mai oia i ke ke Aupuni hapaha; alaila, ua kufono ia ia ka Palapala Lilo Aledia.

Pono nae ia ia ke uku no ka hookekele a me ka hookele ana i ka olelo. Penei:

- W. L. Lee No ka sumi a me ke pai ana i ka olelo ma ka Aupuni.
- G. M. Robertson No ke kope ana i ka olelo kiina
- No ka hana ana i ka la 10 Iulai 1850
- St. Smith No ka palapala kii
- No ke kope ana i na olelo a ma hoi ke 2/3 Awar
- No ke ana ana i ka la 18 o Pepeluwaha 1851.
- I. Kekaulahe No ke kope ana
- Loani Li No ka hookele ana i ka olelo Augate 12, 1852.

Pau loa

6

Oia na palena. Anai a A. F. Turner.

Apana 4. 3 Loo Kalo ma Kahawali, Kouhulu, Oahu.
 E hooika ana ma ke kiki Koua, a e hoo ana Akau 27 1/2 No. 333 paunuku e pili ana i ke Pihiliili; Ak. 65 Ki. 73 paunuku e pili ana i ke Kollua; Koua 24 Ki. 321 paunuku e pili ana i ke Palole; Koua 55 Kom. 55 paunuku e pili ana i ke Kollua i ke kiki mau.
 Ka ihi 0. 218 Eka.

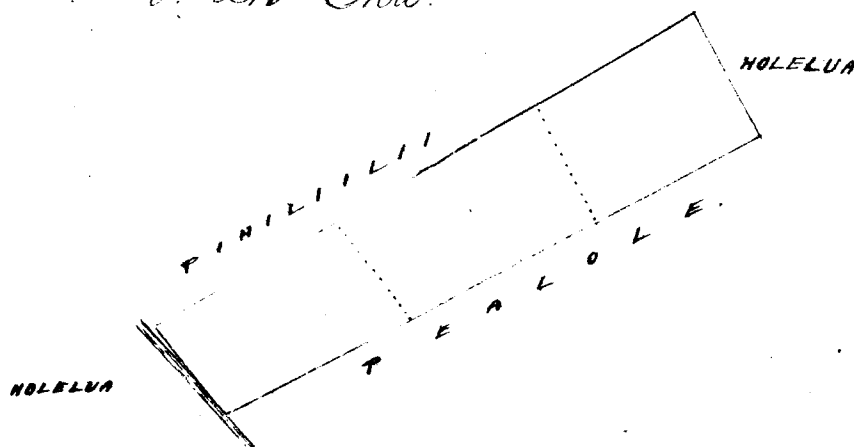

Volu 2103 Kauhunua (no W.B. Kauhakualii)

Ma kei mai oia me kona ma ^{mau wahi} Kahawali a me Kouhaukoi ma Honolulu. Kona ma ka Mikupuni o Oahu, me ka mea, na lea ia ia keia mau wahi no Kauhakualii mai ka Apana 1, a no Pealole mai ka Apana 2, a no Kaaraoheua maika Apana Ekele, Lona ka Apana 1 i ka M.H. 1834, a o ka Apana 2 i ka M.H. 1839, a o ka Apana 3 i ka M.H. 1831, a pa nuku keakea oleia a hiki i keia manawa.

Oia ka maku e hoko nei me Kauhunua, no W.B. Kauhakualii, ke kuleana hoi kona malalo o ke Ano Alodio. Ina e ukui mai oia i ke ke Kupuni hapaha; alaila ma kupaona ia ia ka palapala Lela Alodio.

- Pono mai ia ia ke ukui no ka hoko holo a me ka hoko ana i ka olelo Penei;
- No ka luma a me ke paia ana i ka olelo ma ka Inupua
- No ke kope ana i ka olelo koina
- No ka palapala kii
- No ka hana ana i ka la 10 o Iulai 1850 & 17 o Iulai & 24 o Iulai
- No ke kope ana i ma olelo a ma hoi ke 3 Awai
- No ke ana ana i ka la 18 o Sepatemaba 1851.
- No ke kope ana
- No ka hoko holo ana i ka olelo Augate 12, 1852.

#	Pen.
1	50
1	50
2	—
2	—
	50
	2.50
	<u>7.10</u>

Eia ma palena. Ania e W.B. Turned.

Apana 1. Kauhakualii ma Kahawali, Honolulu, Oahu.
 E hoomaka ana ma ke kahi Akau, a e holo ana Kona 50° Kom. 119 pautu e fili ana i ke Kauhakualii; Kona 5° Kom. 56 pautu e fili ana i ke Honolulu; Kona 52° Kom. 117 pautu e fili ana i ke Kauhunua; — Kona 44° Kom. 60 pautu e fili ana i ke I. Kono. i ke kahi ma.
 O. 0675 o ka Eka.

Apana 2. Poi ma Kouhaukoi i Honolulu, Oahu.
 E hoomaka ana ma ke kahi Akau, a e holo ana Kona 34° Kom. 47 pautu e fili ana i ke ke Honolulu; — Kona 46° Kom. 205 pautu e fili ana i ke ke Honolulu Kauhunua; Kona 80° Kom. 34 pautu e fili ana i ke Kauhunua; — Kona 13° Poi. 56 pautu e fili ana i ke Kouhaukoi; Kona 49° Kom. 186 pautu e fili ana i ke Kauhunua i ke kahi ma.
 O. 12 o ka Eka.

Apana 3. Poi ma Kouhaukoi, Honolulu, Oahu.
 E hoomaka ana ma ke kahi Kona, a e holo ana Kona 55° Kom. 140 pautu e fili ana i ke Kauhunua; Kona 58° Kom. 154 pautu e fili ana i ke Kauhunua; — Kona 61° Kom. 96 pautu e fili ana i ke Kauhunua; — Kona 42° Kom. 152 pautu e fili ana i ke Kouhaukoi; i ke kahi ma.
 O. 168 o ka Eka.

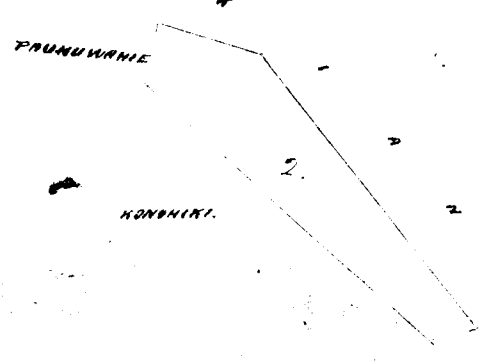
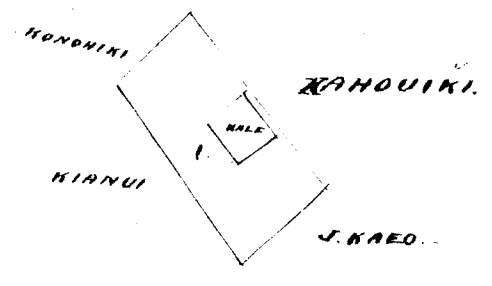
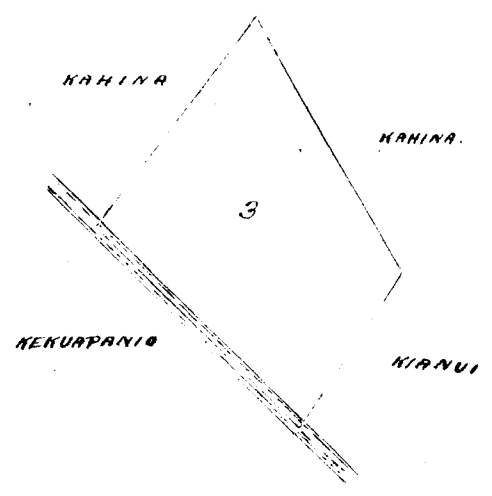

Ua koi mai oia no kona mau wahi ma Kukona, he Kirina ma Waimano Ewa ma ka Mokupuni o Oahu, no ka mea, ua loa ia ia keia mau wahi no ke Alii Kamehameha III mai i ka Mahule aina ana i ka M.H. 1848, a ua noho keia oleia a hiki i keia manawa.

Oia, ka maku e hooko mi no John Stevenson, he kuleana heikona malalo o ke Apo Alodir. Ipa e uku mai oia i ke ke Kupuni hapaha; aiala, ua kupuni ia ia ka Palapala Lila Alodir. Koe mau na kuleana oia kanaka malalo.

Ipa mai ia ia ke uku no ka hookolekole a me ka hookole ana i ka olelo. Penci, - \$ Ken

- W. L. Lee No ka rumi a me ke fua ana i ka olelo ma ka Mufepa.
- G. M. Robertson No ke kope ana i ka olelo Kirina 1/2 Uao No ka palapala kii
- D. H. Smith No ka hana ana i ka la No ke kope ana i ma olelo a nu hoike No ke ana ana i ka la Ukuia ke ana ana \$15.
- J. Fekaudakar No ke kope ana
- Loaru Li No ka hookole ana i ka olelo Augate 14, 1852. Pau loa \$ 10.

Eia na palena. Anaia e A Bishop.

Apana 1. Loko Kukona, ma Waimano Ewa, Oahu.

E hoomaka makei iho o ka Loko Kukona, i hulu ana Kema 33° Hikina 1.00 kh. ma ka palena oia o Waimano Malaila aku Kema 49° Komohana i 1.00 kh. ma ka palena kii ma Waimano Malaila aku Kema 47° Komohana 1.00 kh. Malaila aku Kema 29 1/2° Komohana i 1.00 kh. Malaila aku Kema 47° Komohana 2.00 kh. ma kahakai no Waimano Malaila aku Kema 62° Komohana 0.70 kh. Malaila aku Kema 77 1/2° Komohana 0.30 kh. Malaila aku Kema 88° Komohana i 1.00 kh. ma kahakai no Waimano Malaila aku Akau 75 1/2° Komohana 1.50 kh. Malaila aku Akau 60 1/2° Komohana 0.50 kh. Malaila aku Akau 49 1/2° Komohana 0.50 kh. Malaila aku Akau 33 1/2° Komohana 1.00 kh. ma ka palena kii no Waimano Malaila aku Akau 22 1/2° Komohana 2.00 kh. Malaila aku Akau 66° Hikina 3.00 kh. ma ka palena Loko Awaawaloa Malaila aku Akau 51° Hikina 2.80 kh. Malaila aku Kema 40 1/2° Hikina 1.50 kh. ma ka palena Loko o Lapaakahai no Malaila aku Kema 66° Hikina 1.60 kh. Malaila aku Akau 67 1/2° Hikina 0.70 kh. a hiki i ka hoomaka ana. 3 Eka 2 33/100 kaula ha huihana.

Apana 2. Eha Moaia, Apikiipiki, Kahahalike, Kapalamat, Kapalama 2, iloko o ka Ki o Kukona, Waimano Ewa, Oahu.

E hoomaka ma ke kiki Kema, e hulu ana Akau 51° Komohana 4.00 kh. ma kahawai Malaila aku Akau 34° Komohana 1.90 kh. Malaila aku Akau 28° Kom. 1.70 kh. Malaila aku Akau 3 90 kh. ma kahawai Malaila aku Kema 80 1/2° Komohana 1.20 kh. Malaila aku Akau 30° Komohana 1.20 kh. ma ka palena o Kopuni Malaila aku Akau 52° Hikina 1.00 kh. Malaila aku Akau 22° Komohana 1.00 kh. ma ke kula o Kaha Malaila aku Kema 79° Hikina 5.40 kh. ma ka papipi Malaila aku Kema 12° Hikina 3.90 kh. ma ka palena o Kaluwa. Malaila aku Kema 75° Kom. luma 0.80 kh. Malaila aku Kema 8° Hikina 3.00 kh. ma ka palena o Kaluwa Malaila aku Kema 12° Hikina 4.95 kh. ma ka palena o Kaluwa Malaila aku Akau 80° Hikina 0.70 kh. Malaila aku Kema 3° Komohana 4.70 kh. a hiki i ka hoomaka ana. 6 Eka, 6 2/100 kh. huihana.

E K 2.39
512 6.91
522 4.24

Apana 3. He Kula no ka Ki o Kukona iloko o Waimano Ewa, Oahu.

E hoomaka ma ke kiki Komohana Kema ma ka palena o Mananani, e hulu ana Kema 84° Hikina 16.00 kh. maluma o ka paama Malaila aku Kema 73° Hikina 11.00 kh. ma ka paama Malaila aku Kema 75° Hikina 5.30 kh. a i ka palena o Waiaw Malaila aku Akau 7 1/2° Hikina 16 kh. ma ka palena o Waiaw Malaila aku Akau 36 1/2° Hikina 20.00 kh. ma ka palena o Waiaw Malaila aku Akau 28° Hikina 26.00 kh. Malaila aku Akau 29° Hikina 25.00 kh. Malaila aku Akau 18° Hikina 25.00 kh. ma ka palena o Waiaw a ke kahawai Malaila aku Akau 38° Komohana 40.50 kh. ma ka palena o Waimano-ika Malaila aku

10

Komohana 6,00 kē. Malaila aku Akua 31 Komohana 6,00 kē. a ka lili o ka pali kahawai o Waianai.
 Malaila aku Kema 35 Komohana, i 7,00 kē. ma ka palena kula i Mananani. Malaila aku Kema
 111 Komohana 26,00 kē. ma ka palena o Manana. Malaila aku Kema 9 Komohana 22,35 kē.
 ma ka palena o Mananani Malaila aku Kema 36 Komohana 25,00 kē. Malaila aku
 Kema 26 Komohana i 35 kē. Malaila aku Kema 5 1/2 Komohana 30,00 kē. ma ka palena o
 Mananani a hiki ma ka pohaku ahi i Koomaka'i. 512 1/2 ma Eka ma'ika oia kula.

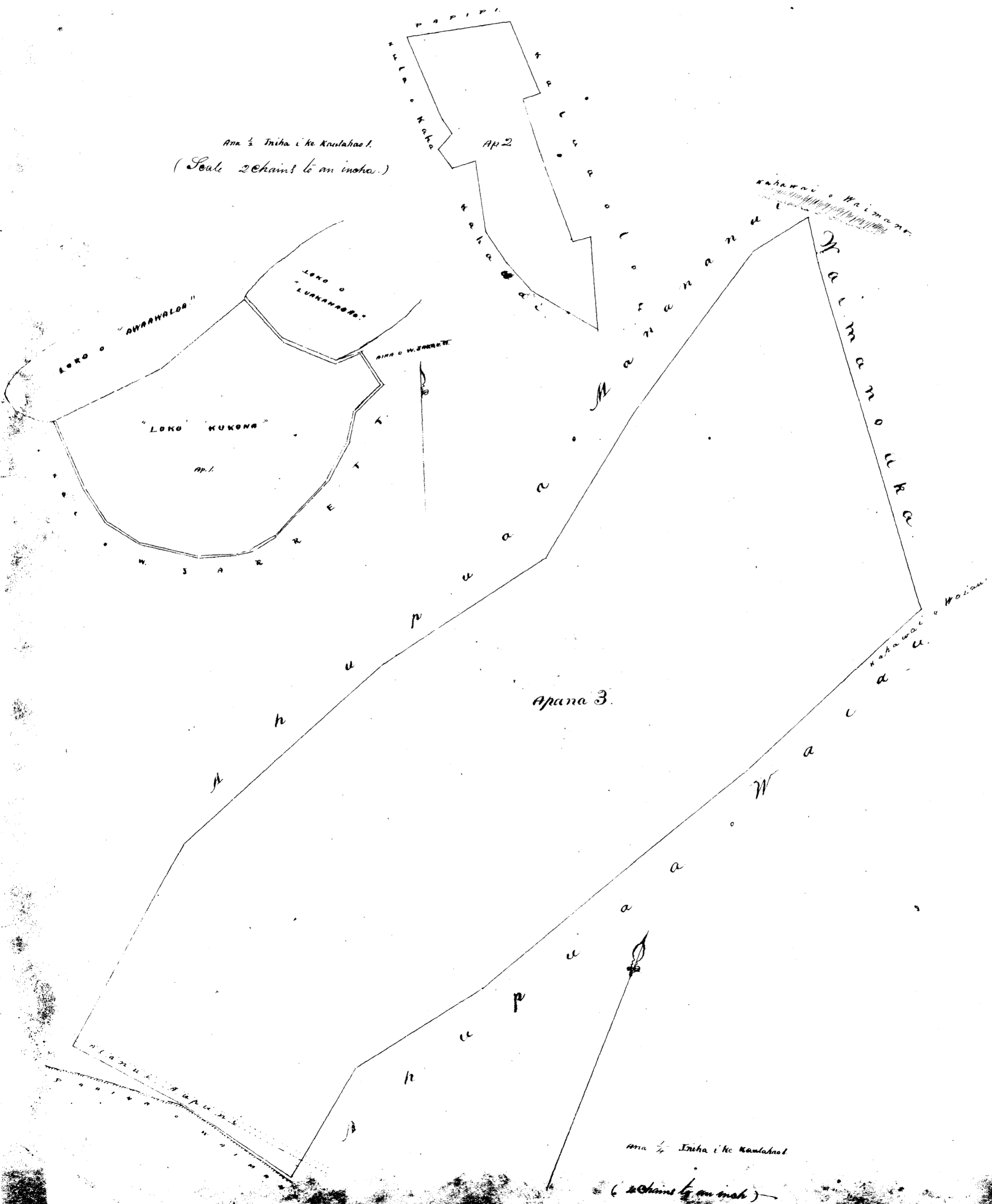

Scale 2 chains to an inch.

Scale 2 chains to an inch.

Ua kwi mai oia no kona mau wahi ma Kamakela i Honolulu China ma ka
 Nookunui o Cahu; no ka mea, ua hooa ia ia keia mau wahi no Naku lo mai i ka manawa o
 Kamehameha I, a ua mau kona wahi ana a hiki i ka makahiki 1845, ma ke iho la, a kaouha
 i keia mau wahi ia Keliichalani kana wakine, a ua noho keia oia a hiki i keia manawa.
 Oia ka maun e hooke nei no Tualelepa ia Keliichalani, he hooeana kwi kona malalo
 e ke Ano Alodio Ina e utu mai oia i ke ke Aupuni hooeana; alaila, ua hooe ia ia ka Palapala
 Pila Alodio.

Penae nae ia ia ke utu ma ka hookelelele a me ka hookelelele ana i ka olelo.

	#	Ken.
No ka rumu a me ke paai ana i ka olelo ma ka Mapepa	1	—
No ke kope ana i ka olelo keina		50
No ka palapala kii		50
W. Lee No ka hana ana i ka la 23 Iulai 1851	1	—
No ke kope ana i na olelo a ma hookelele 1/3 Ua		75
J. Kekaulaha No ke anahana i ka la 3 o October 1851	2	—
G. M. Robertson No ke kope ana		50
J. D. Smith No ka hookelele ana i ka olelo, Aug 20, 1852.		250
Loana Si		—
Oia na palena. Anoa o A. F. Sumner.		875

Ahana 1. Lei ma Kamakela, Honolulu, Cahu.
 E hooe ana ana ma ke hiki Ahan, a e hooe ana Ahan 38° Komohana 287 paunani e
 fili ana i ke Nakuokoo; Ahan 50° Komohana 127 paunani e fili ana i ke Nakuokoo; Ahan 39° Komohana 276
 paunani e fili ana i ke Nakuokoo; Ahan 46° Komohana 150 paunani e fili ana i ke Nakuokoo i ke hiki
 ana.
 o. 375 Eka.

Ahana 2. Lei o Kahuahala ma Kamakela, Honolulu China, Cahu.
 E hooe ana ana ma ke hiki Ahan, a e hooe ana Ahan 45° Komohana 173 paunani e fili
 ana i ke Nakuokoo; Ahan 49° Komohana 47 paunani e fili ana i ke Paale; Ahan 50° Komohana 32
 paunani e fili ana i ke Paale; Ahan 37 1/2° Komohana 101 paunani e fili ana i ke Paale; Ahan 45° Komohana
 60 paunani e fili ana i ke Alamu liliu; Ahan 41 1/2° Komohana 52 paunani e fili ana i ke Alamu liliu;
 Ahan 7 1/2° Komohana 57 paunani e fili ana i ke Alamu liliu; Ahan 33° Komohana 30 paunani e fili ana
 i ke Alamu liliu; Ahan 36° Komohana 47 paunani e fili ana i ke Alamu liliu i ke hiki ana.
 o. 146 Eka.

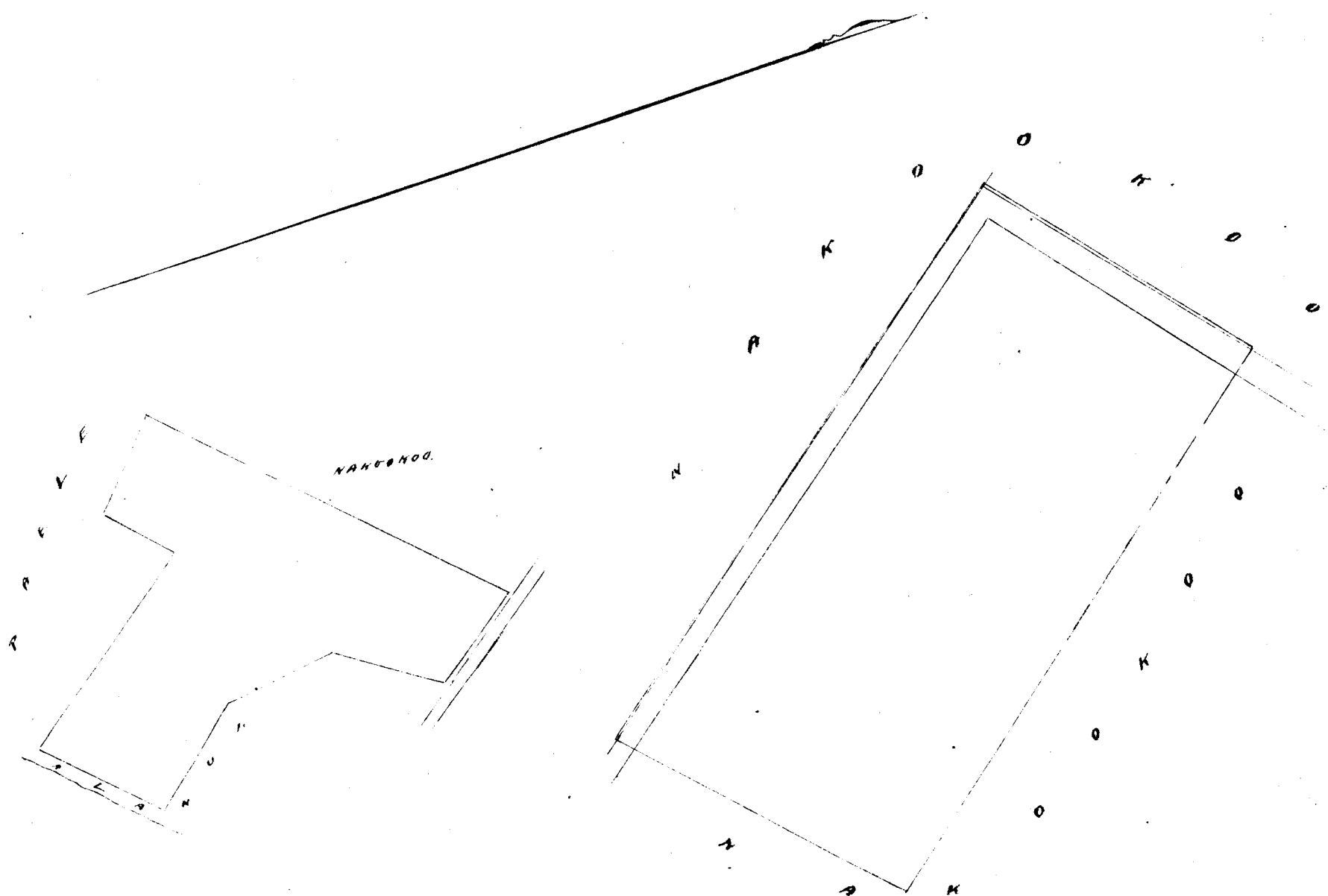

Hele 3812 Luiki

Ua hui mai ia no kona mau wahi mai Hamakua ana Honolulu Oia, ma ka Mokupuni o Oahu; no ka mea, ua loa ia ia keia mau wahi no Makahoupa mai i ka manawa o Pahi manawa aku o ka makahiki 1829, a ua noho keakea oia a hiki i keia manawa.

Oia ka moku e hoohe iho no Luiki, he kuleana hoohe maatua e ke Auniolele. Ima e uku mai oia iho ke Auniolele hapaha; aiaho, ua kupaia ia ia ke Palapala Ika Oledia.

Pono nae ia ia ke uku no ka hoohehele a au ke hoohehele ana i ka olelo. Peni; # Hen.

No ka rui a me ke fua ana i ka olelo ma ka Mopapa.

No ke kope ana i ka olelo kama

No ka palapala kii

No ka hana ana i ka la 21 o Iulai 1851.

W. Lee

No ke kope ana i ka olelo a ma hoohe 13 Awar

G. M. Robertson

No ke ana ana i ka la 11 o October 1851.

J. H. Kaulahala

No ke kope ana.

J. H. Smith

No ka hoohehele ana i ka olelo Augata 21, 1852.

J. H. Smith

W. H. P. # 6

• Oia na palena

Maia e A. S. Turner.

Apana 1. I ka lalo ana Hamakua, Honolulu Oia, Oahu.

E hoomaka ana ma ke kiki Oahu, a e holo ana

Kama 56° Kikina 78 fanku e pili ana i ke Koolaha

" 28° Komehana 76 " " " Kookopa

Akau 58° " 26 " " " "

Kama 40° " 104 " " " "

Akau 61° " 37 " " " " " " "

Kama 57° " 121 " " " " "

Kama 38 1/2° " 108 " " " "

Akau 38° " 44 " " " " "

Akau 12° Kikina 100 " " " " ma ka Auwai

Akau 38° " 141 " " " " " i ke Lilipi

Akau 57° " 90 " " " " "

Kama 52 1/2° " 90 " " " " "

Akau 38° " 67 " " " " "

i ke kiki maua.

43 Eka.

Apana 2. Pahale ana Hamakua, Honolulu Oia, Oahu.

E hoomaka ana ma ke kiki Kama, a e holo ana Akau 67° Komehana

68 fanku e pili ana i ke Kookopa; Akau 35° Kikina 26 fanku e pili ana i ke Kookopa.

Kama 51° Kikina 65 fanku e pili ana i ke Luiki Ioi; Kama 55° Komehana 9 fanku e pili ana i ke Luiki Ioi, i ke kiki maua.

0. 011 o ka Eka.

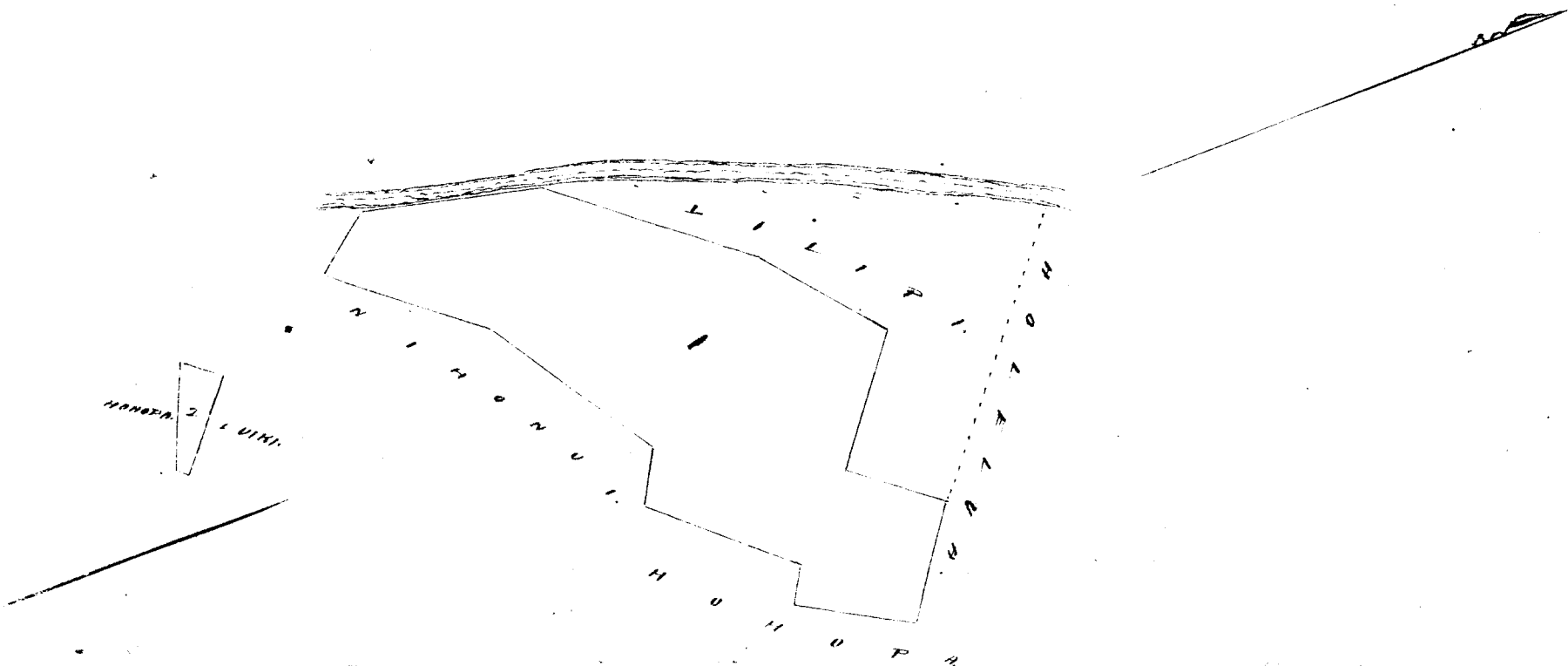

Na koi mai oia no kona wahi ma Kamakela ma Honolulu Aina, ma ka Hekejumu Oahu; no ka mea, ua loa ia ia keia wahi no no Lilitipi mai i ka wa o Peki, manawa aku e ka 1829, a ua noho kahea oleia a hiki i keia manawa.

Oia ka makou e hooke nei no Lilitipi, he huleana hei kona malalo o ke Awa Olole. Iua e uku mai oia i ke ke Aupuni hapaha; alaila, ua kopeo ia ia ka Palapala Pita Olole. Ima nua ia ia ke uku no ka hookelelo a me ka hookelelo ana i ka olelo. Tenei

Hon.

No ka sumi a me kopei ana i ka olelo ma ka Napapa.

W. A. Lee

No ke kope ana i ka olelo heina

G. M. Robertson

No ka palapala kii

J. H. Smith

No ka hana ana i ka la 24 o Iulai 1851.

J. Kakaulaha

No ke kope ana i na olelo a me hooke 1/2 Awa

L. Rossi

No ke ana ana i ka la 11 o October 1851.

No ke kope ana

No ka hookelelo ana i ka olelo Augate 21, 1852.

Uku pau loa

5

Eia na palena.

Anaia e A. F. Turner.

11 Lii Hale ma Kamakela i Honolulu Aina, Oahu.

E hoomaka ana ma ke kiki Heema, a e holo ana

Akau 38° Hikina 141 paku e pili ana i ke Lilitipi.

Akau 50° Hikina 90 " " " "

Heema 52° Hikina 90 " " " "

Akau 38° Hikina 67 " " " "

Akau 52° Kamehana 190 " " " Helelu

Heema 28° Kamehana 157 " " " ka Auwai

Heema 12° Kamehana 158 " " " "

i ke kiki mua.

21/100 Eka.

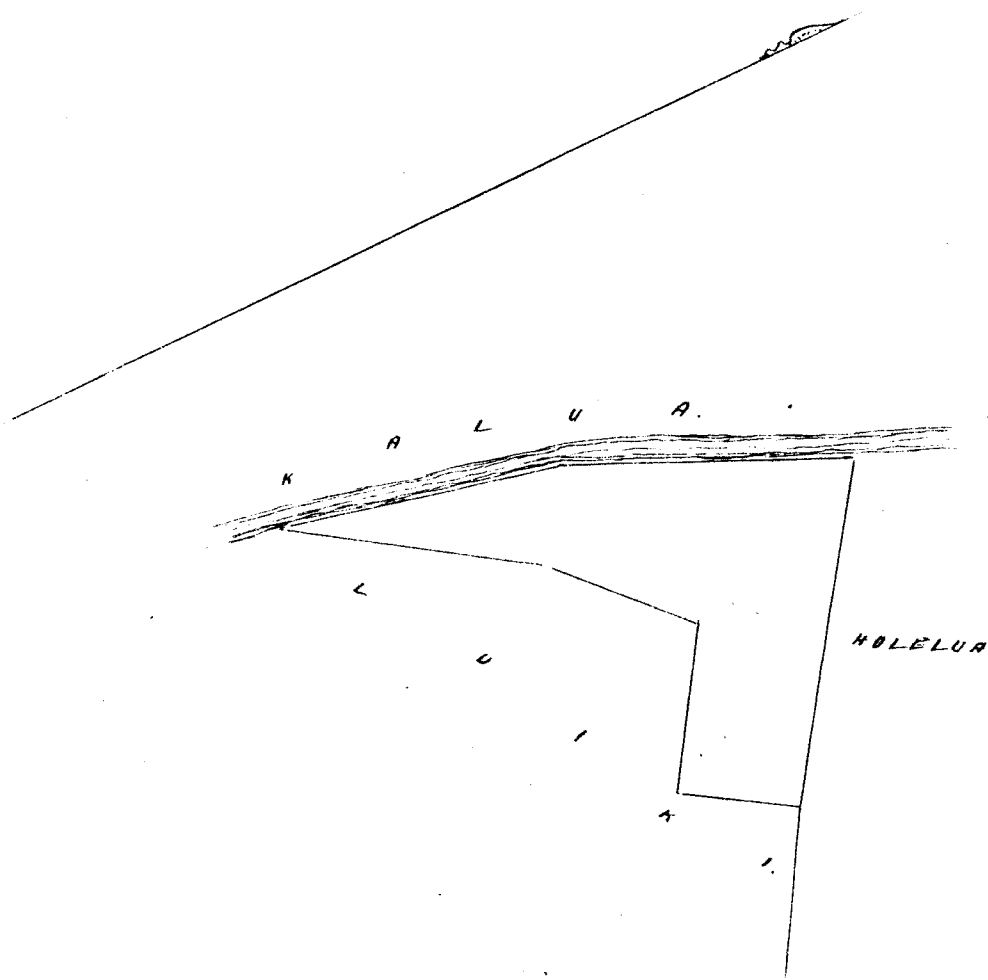

Kulu 7880 Kaala

Ua hui mai oia no kona wahi ma Kahahuna ma Honolulu Aina, ma ka Moku o Cahu; no ka mea, ua loaa keia mau wahi no Lono mai kona makua kame mahu ahu o ka mate ana o kona makua kame, a ua noho keakea oleia a hiki i keia manawa.

Cia ka maku e hoko nei no Kamea, ke hulu ana hoi kona malalo o ke Awa Uluhi. Ina e uku mai oia i ke ke Uluhi hupaha; alaila, ua hopeno ia ia ka Palapala Lila Uluhi.

Ua mai iaia ke uku no ka hoko hoko a ma ka hoko ana i ka olelo. Penei:

		\$	Ken.
W. L. Lee	No ka nuni a me ke hui ana i ka olelo ma ka Napapa	1	-
G. M. Robertson	No ke kope ana i ka olelo kama	50	-
	No ka palapala hii	50	-
J. H. Smith	No ka hana ana i ka la 29 o Apirila 1851	1	-
	No ka kope ana i na olelo a na huike 13 Aho	75	-
J. Kekaulahas	No ke ana ana i ka la 30 o Augata 1851.	4	-
	No ke kope ana i ka olelo	50	-
Loave Li	No ka hoko ana i ka olelo Augata 21, 1852.	2	50
		10	75

Eia na palena. Ania e A. F. Turner.

Apana 1. W. L. ma Kahahuna, Honolulu Aina, Cahu.

E hui ana ma ke hiki Komohana Aho, a e holo ana

Akau 59	Hikina 332	pauna e pili ana i ke Puna	
Hikina	70	"	"
Hema 70	Hikina 210	"	"
Hema 69	Komohana 32	"	"
Akau 25	Komohana 127	"	"
Hema 59	Komohana 92	"	"
Hema 12	Hikina 55	"	"
Hema 78	Komohana 150	"	"
Hema 69	Komohana 134	"	"

i ke hiki, alaila e pili ana i ke kahuwii i ke hiki mua. 1,036 Eka.

Apana 2. Puhala ma Kahahuna, Honolulu Aina, Cahu.

E hui ana ma ke hiki Hikina Hema, a e holo ana

Akau 55	Hikina 265	pauna o pili ana i ke Puka.	
Akau 32	Komohana 28	"	"
Akau 52	Komohana 190	"	"
Hema 51	Komohana 122	"	"
Hema 32	Hikina 136	"	"

i ke hiki mua.

3
10 Eka

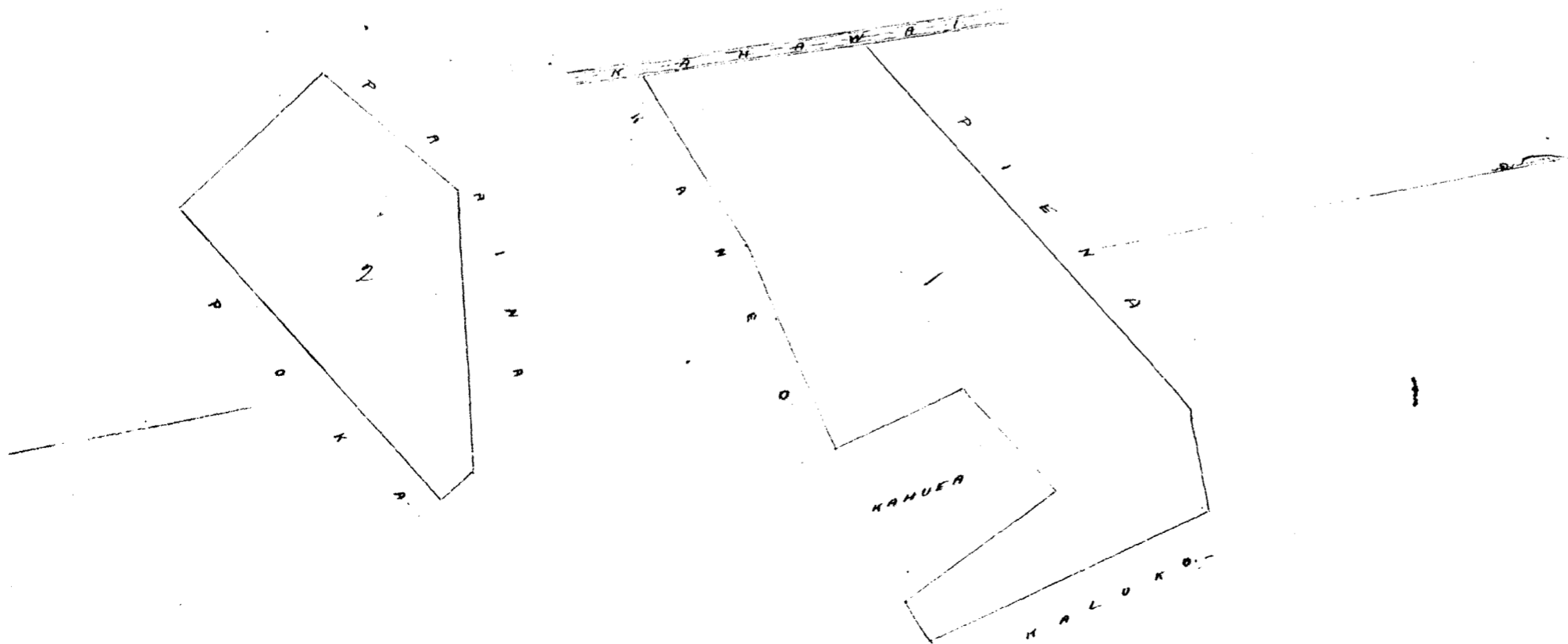

Helu 3147 Niua

Ua koi mai oia no kona mau wahi ma Kaakopuna i Honolulu Aina, ma ka Moku o
 Oahu; no ka mea, ua loaia kua mau wahi no Kihikihi mai, a ua loaia hoi ia Kihikihi i ka manawa
 o Kalaimoku a me Peki, a ua noho keakea oia a hiki i keia manawa.

Oia ka moku e hooke nei no Niua, he kuleana hoi kona malalo o ka Aunali'i.
 Ina e utu mai oia i ke ke Aupuni hapaha; alaila, ua kupaia ia ia ka Pulepala Pila Alletti.
 Pono nae ia ia ke utu no ka hookelele a me ka hoohele ana i ka olelo. Pono,

		\$	Eka.
<i>W. Lee</i>	No ka pumi a me ke pui ma i ka olelo muka kupaia	1	0
	No ke kope ana i ka olelo kama	50	0
<i>G. M. Robertson</i>	No ka pulapala hii	50	0
<i>J. H. Smith</i>	No ka hana ana i ka la 12 Augate 1851	1	0
	No ke kope ana i na olelo a ma hoi ke 13 Awar	25	0
<i>J. Kekaulahas</i>	No ke ana ma i ka la 30 October 1851.	2	0
<i>J. me Li</i>	No ke kope ana	0	0
	No ka hoohele ana i ke olelo, Augate 21, 1852.	2	0
		5	0

Oia na pulena. Ania e A. S. Turner.

Apana 1. 1 Li ma Kaakopuna, Honolulu Aina, Oahu.
 E hoomaka ana ma ke kiki Akaa, a e holo ana Kema 50 Kom. 76 pauna e pili ana i ke
 ke Kauhiki; Kema 41 Hiki 198 pauna e pili ana i ke Nalii; Akaa 47 Hiki 78 pauna e pili ana i ke
 Kaipuaa; Akaa 40 Kom. 198 pauna e pili ana i ke Kelihehena i ke kiki ana. 100 Eka.

Apana 2. 2 Li ma Kaakopuna, Honolulu Aina, Oahu.
 E hoomaka ana ma ke kiki Akaa, a e holo ana Kema 42 Kom. 190 pauna e pili ana i ke
 Kelihehena; Kema 42 Hiki 162 pauna e pili ana i ke Kaupuaa; Akaa 42 Hiki 232 pauna e pili ana i ke
 Kauhiki; Akaa 45 Kom. 38 pauna e pili ana i ke Kaipuaa; Kema 45 Kom. 27 pauna e pili ana i ke
 Kaipuaa; Akaa 49 Kom. 78 pauna e pili ana i ke Kaipuaa i ke kiki ana. 100 Eka.

Apana 3. 1 Li ma Kaakopuna, Honolulu Aina, Oahu.
 E hoomaka ana ma ke kiki Kema, a e holo ana Akaa 40 Kom. 40 pauna e pili ana i ke
 Kelihehena; Akaa 49 Hiki 128 pauna e pili ana i ke Nalii; Kema 41 Hiki 43 pauna e pili ana i ke
 Kema holo; Kema 49 Kom. 128 pauna e pili ana i ke Kanaana i ke kiki ana. 100 Eka.

14
35
5
54

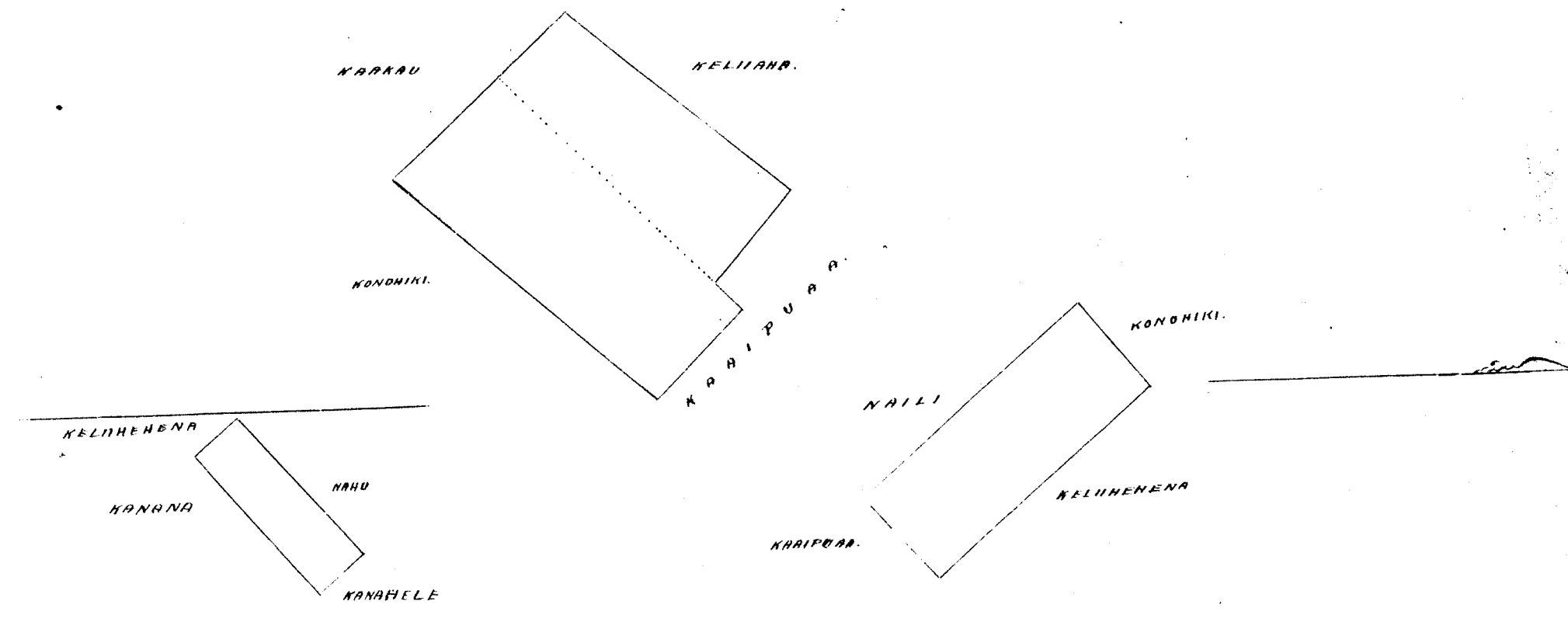

Kedu 5573 Kualii

Ua kii mai oia no kona wahi ma ke Kulanakauhale o Honolulu, ma ka Mokupuni o Oahu; no ka mea, ua loa ia ia kii wahi no Kalaimoku mai i ka manawa mamua loa, a ua nohi keakea oia a hiki i kii manawa.

Oia ka maku e hiki mai no Kualii, he kuleana hoi kona malalo o ka Awa Aloha. I no a ika mai oia i ke ke Aupuni hapaha; alaila, ma kufuno ia ia ka Palapala Sila Aloha. Pono nua ia ia ke utu no ka hoohelehele a ike ka hoohele ana i ka olelo. Penei, —

		\$ Cen.
W. Lee	Ke ke iumi a me ke pui ma i ka olelo ma ka Mufupa	1 -
	Ke ke kope ana i ka olelo kama.	50
J. H. Smith	Ke ka palapala kii	50
	Ke ka huna ana i ka la 21 o Augate 1848.	1 -
J. Kekaulahao	Ke ke kope ana i na olelo a ma hiki 1/2 Cen	75
G. M. Robertson	Ke ke ana ana i ka la 29 o October 1851	2 -
	Ke ke kope ana	50
Jo me di	Ke ka hoohele ana i ka olelo, Augate 21, 1852.	2 50
		\$ 8.75
Eia ma pulema.	Maia o A. F. Turner.	

Pahulu ma ke Kulanakauhale o Honolulu, Oahu.

E hoomaka ana ma ke kii Kama, a holo ana

Ahan	39°	Kikina	208	pauku	e	pili	ana	i	ke	Kalaimoku
Ahan	49°	Komohana	116	"	"	"	"	"	"	"
Kama	42°	Komohana	101	"	"	"	"	"	"	Makua
Kama	42°	Kikina	50 1/2	"	"	"	"	"	"	"
Kama	41°	Komohana	114	"	"	"	"	"	"	"
Kama	59°	Kikina	75	"	"	"	"	"	"	ke Alamii Kua.
i ke kii ma.										
			35	Eka.						
			100							

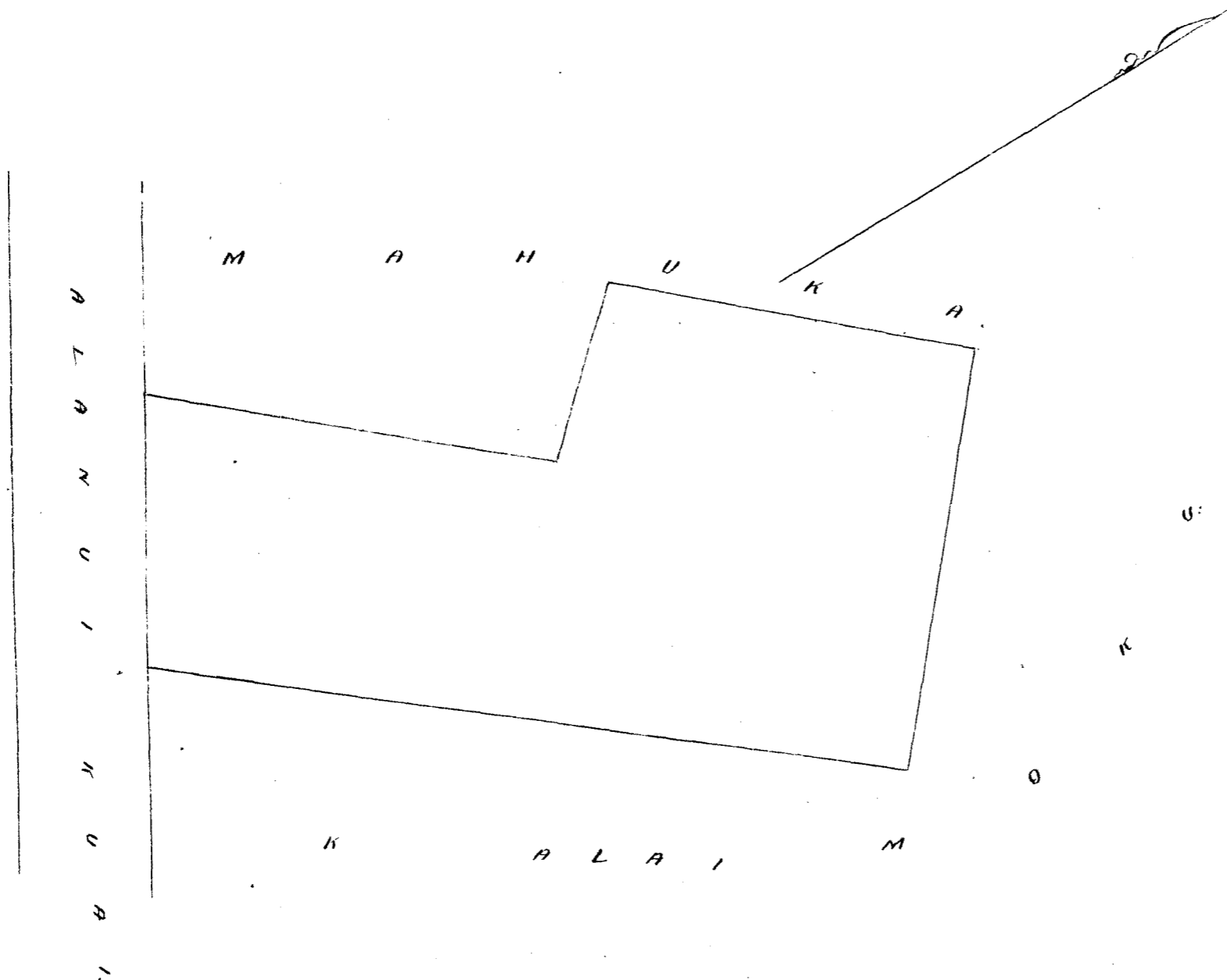

Ue. Koi mo'i oia no kema wahi ma Kahawahi i Kemululu Aina, ma ka Moku-puni e Catwi; no ka mea, ua loa ia ia keia wahi no Kae mo'i i ka wa e ola ana e Hinan mamua aken e ka M.H. 1839, a ua nohu keakea oleia i hiki i keia manawa.

Oia ka moku e hooke me'i no Pealole; ke kuleana hoi kema mulalo o ke Ano Alodio. Ima e uku mui oia i ke ke Aupuni hapaha; alaila, ua kuleana ia i ke Palapala Pila Alodio.

Tene nua ia ia ke uku no ka hookele kolo a me ka hoohele ana i ka olelo. Penei,

		\$	Pen.
H. J. Lee	No ke puni a me ke p'ai ana i ka olelo ma ka Moku-puni.	1	-
G. M. Robertson	No ke kope ana i ka olelo koina.	50	-
	No ka palapala kii	50	-
J. H. Smith	No ka hana ana i ka la 10 & 17 o Iulai 1850	1	-
	No ke kope ana i na olelo a na hiki 1/2 Awar.	75	-
J. Ekeaulahas	No ke ana ana i ka la.	2	-
L. M. S. S.	No ke kope ana.	50	-
	No ka hoohele ana i ka olelo, Augata 21, 1852.	2	50
		\$	8.75
Eia ma palena.	Anaia e James Dillen.	2	75
		\$	6.00

Penei ma palena. Ma ka awa mauka ke Kae, Kema 24 1/2 Kikina 294 fathoms; Ma ka awa ma Waitiki ka Auwai, Kema 55 1/2 Kikina 200 fathoms; Ma ka awa mauka ke Kauhunua, Akau 26 1/2 Kikina 328 fathoms; Alaila, ma ka awa ma Ewa ke Kapua, Akau 65 1/2 Kikina 197 fathoms.

Ma ia Apua 741.3 Anana.

^{translation}
Bounded, on the Mauka side by Kae S. 24 1/2 E. 294 links, on the Waitiki side by a Stream S. 55 1/2 W. 200 links, on the Mauka side by Kauhunua N. 26 1/2 W. 328 links, thence on the Ewa side by Kapua N. 65 1/2 E. 197 links.

Contains 741.3 Fathoms.

Scale 2 Chains to an inch

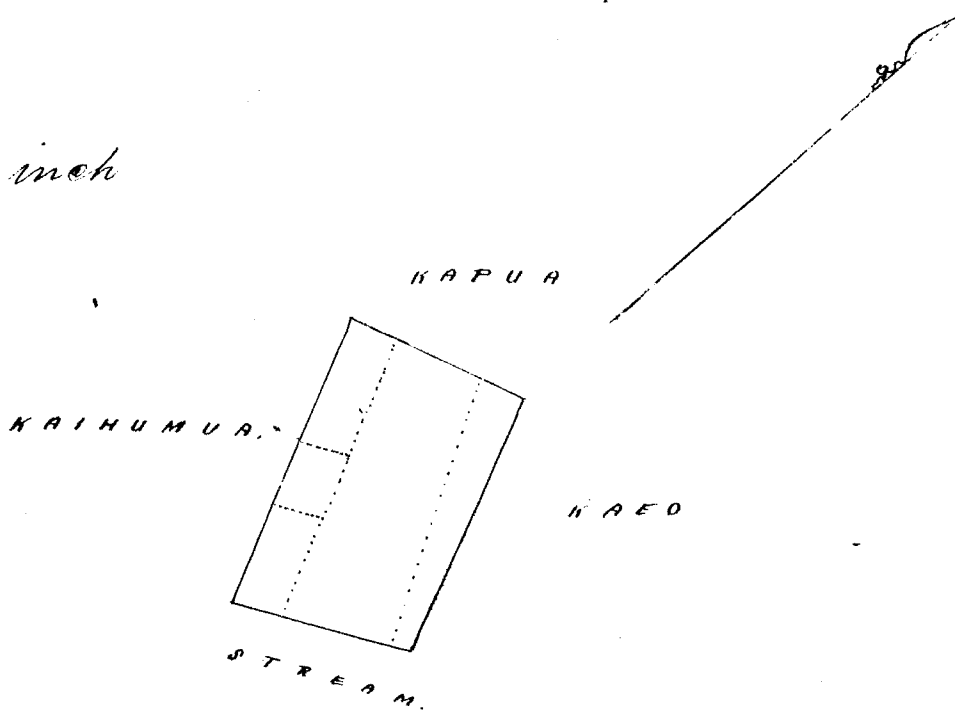

Kulu 1156 Kupu

Ua kii mai oia no kona wahi ma Hanaukoi, Honolulu Oahu, ma ka Mokupuni o Oahu, no ka mea, ua loa ia ia keia wahi no Kanakoo mai i ka wa o ka huanale a Lord George Paulet i ka M. 4. 1843, a ua loa hui ia Kanakoo no Kahu mai kona kaitaina, a ua loa hui ia Kahu no Kaarohema mai ka Honolulu mamua a ka muke ana o Mahienana i ka M. 4. 1836, a ua noho keakea oia i hiki i keia manawa.

Oia ka maku e hoko nei no Kupu, ke kule ana hoi kona malalo o Pi Ahlo Aloha. Ana e uku mau ia i ke ke Kupuni hapaha, alaila, ua kupa ia ia ka Palapala Pila Aloha. Iono nae ia ia ke uku no ka hoko kolo a me ka hoko ana i ka olelo. Ionei:

M. M. M.	No ka maku a me ka pai ana i ka olelo ma ka Kupu.	\$ 1 -
G. M. Robertson	No ke Kupu ana i ka olelo koma.	50
J. H. Smith	No ka palapala kii	50
J. H. Smith	No ka koma ana i ka la 15 o October 1851.	1 -
J. H. Smith	No ke Kupu ana i na olelo a me hiki.	75
J. H. Smith	No ke ana ana i ka la 20 o October 1851	3 -
Jane J.	No ke Kupu ana	50
Jane J.	No ka hoko ana i ka olelo. Augate 21, 1852.	2 50
Eia na palena.	Anaia e A. F. Turner.	\$ 9.75
		Ema 3.75
		\$ 6.00

Ua i ka Kahuakale ma Hanaukoi, Honolulu Oahu, Oahu.

E hoomaka ana ma ke kiki Oahu, a e holo ana

Koma	33°	Hikina	188 fanku	e pili ana i ke	N. Hoolio mamua.
Koma	46°	Komohana	68	"	" " Lipolio
Koma	43°	Hikina	222	"	" " "
Koma	80°	Komohana	114	"	" " Honolulu
Akau	47°	Komohana	320	"	" " Pihiliili
Akau	39°	Hikina	220	"	" " Kupu

i ke kiki mau

$\frac{53}{100}$ Eka.

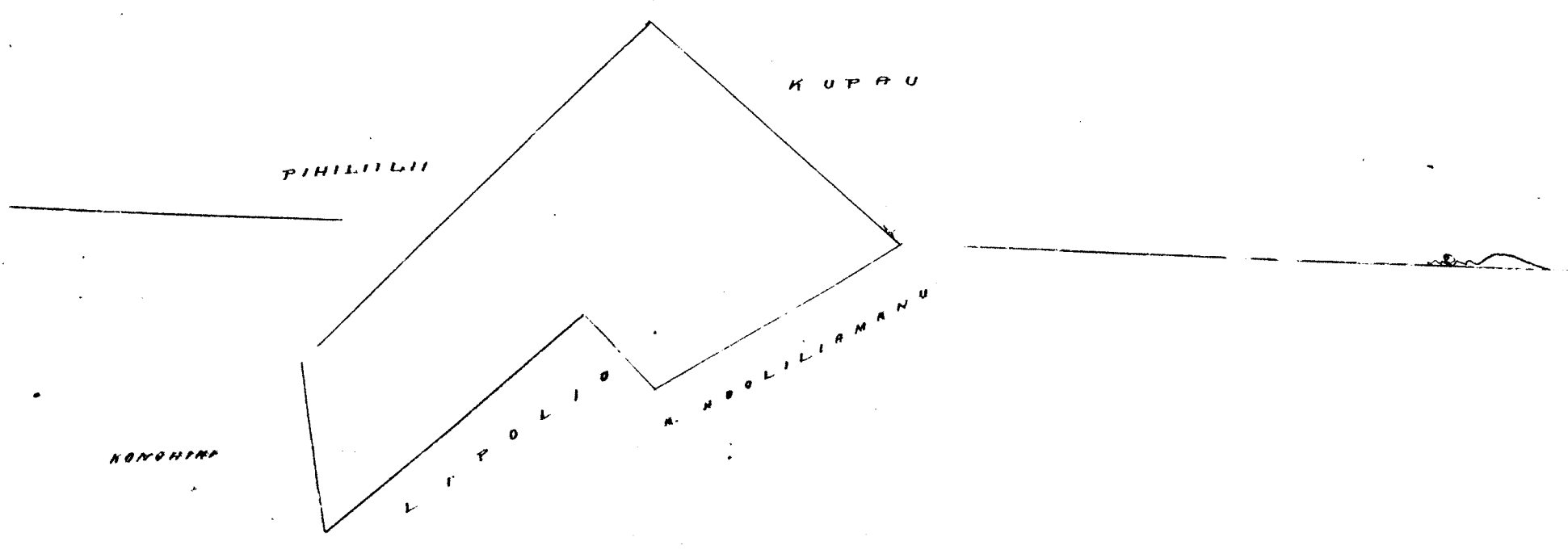

Ua hoi mai oia no kona wahi ma Heoneuta i Honolulu Aina, ma ka Mokupuni o Oahu; no ka mea, ua loaa iu ia keia wahi no Kalunacima mai i ka manawa e ola ana o Hinan mamua aku o ka M.H. 1839, a ua noho keakea oleia a hiki i keia manawa.

Oia ka maha e hoohe nei no Honu, ke huleana hoi kona malalo o ke Ano Alodio. Ina e uku mai oia iho ke Aupuni hapaaha; alaila, ua hupopo iaia ka Palapala Pila Alodio.

Ua nae iu ia ke uku ma ka hoohelele a ma ka hoohelele ana i ka olelo. Ina e -

		\$	Ken.
W. Lee	No ka nuni a me ke paia ana i ka olelo ma ka hupopo.	1	-
G. M. Robertson	No ke kope ana i ka olelo keia	50	
	No ka palapala hii	50	
J. H. Smith	No ka hana ana i ka la 28 i Iune 1848	1	-
	No ke kope ana i ma olelo a ma hoohelele 1/2 arar	75	
J. Kekaula	No ke ana ana i ka la 20 o October 1851	4	-
	No ke kope ana	50	
Londoni	No ka hoohelele ana i ka olelo, Augate 21, 1852.	2 50	
Eia ma palena.	Anaia e A. F. Turner.	10.75	
		Emi	2.75
			8.00

O Loi Kalo o Kalunahale ma Heoneuta, Honolulu Aina, Oahu.

E hoomaka ana ma ke kiki Heoneuta, a e holo ana

Akai	43°	Hikina	270	pauna	e pili ana i ka auwai
Akai	45°	Komohana	130	"	" ke Auwai
Akai	35°	Hikina	50	"	" "
Akai	40°	Komohana	219	"	" "
Heoneuta	57°	Komohana	222	"	" " Konoiki
Heoneuta	35°	Hikina	198	"	" "
Heoneuta	42°	Komohana	70	"	" "
Heoneuta	39°	Hikina	212	"	" " Kekipi

i ke kiki ma.

29 Eka.

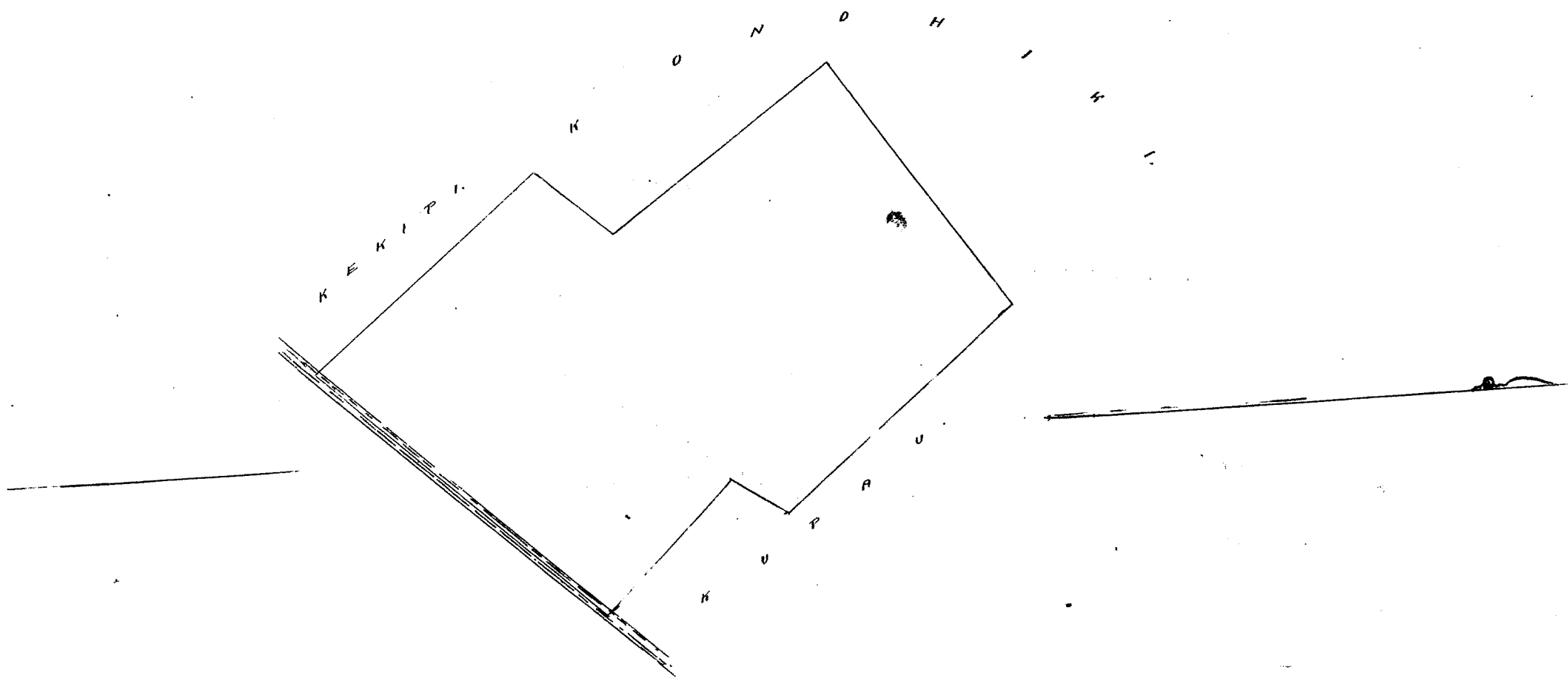

Keilu 2571 Kaai

Ua kei mai oia ma kona wahi ma Lele i Honolulu Aina, ma ka Mokupuni o Oahu; no ka mea, ua loa ia ia keia wahi no Kauiawaawa mai i ka M.H. 1843, a ua noho keakea oleia a hiki i keia manawa.

Oia ka makou e hooke nei no Kaai, ke kuleana hoi kona malalo o ke Auu Alodio. Ina e utu mai oia i ke ke Aupuni kaupuka; alaila, ua kupaia ia ia ka Palapala Lela Alodio.

Sono nae iaia ke utu no ka hookelele a me ka hoohele ana i ka olelo. Peni,-

	\$	Stn.
W. M. Ke	1	-
No ka rumi a me ke pui ana i ka olelo ma ka Kupaia		
No ke kope ana i ka olelo koina	50	
G. M. Robertson No ka palapala kii	50	
No ka kumu ana i kula 23 o Sepatemaba 1851	1	-
J. H. Smith No ke kope ana i wa olelo a ma hoi ke 1/3 Auu	50	
No ke ana ana i ka olelo 20 o October 1851	3	-
J. Kipaulahas No ke kope ana	50	
Loansi No ka hoohele ana i ka olelo, Augate 21, 1852	2.50	
	\$ 9.50	
Eia na palena. Anaia e A. F. Turner	Emi 3.50	
	\$ 6.00	

Kahamahale ma Lele i Koinia, Honolulu Aina, Oahu.

E hoomaka ana ma ke kahi Akau, a e holo ana

Hema	5 1/2	Kipina	54	pauku	e fili ana i ka muliwai	
Hema	61 1/2	Komohana	90	"	"	ko Malakoa
Akau	84	Komohana	35	"	"	"
Hema	62	Komohana	68	"	"	"
Akau	18	Komohana	63	"	"	"
Akau	70	Kipina	190	"	"	Alagani Alii
				"	"	C. G. Hopkins

i ke kahi mua.

O. 10935 Eka.

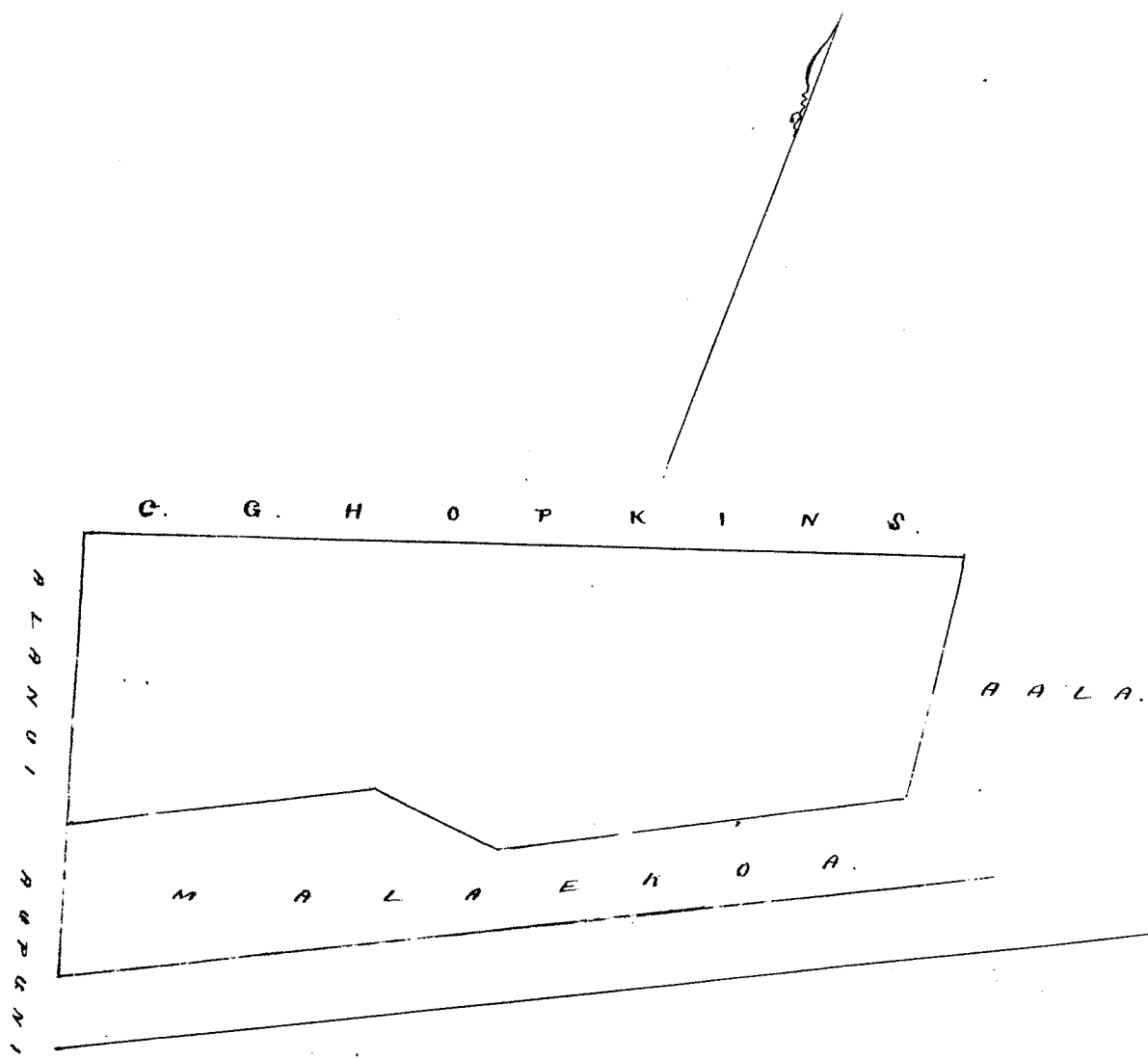

Hulu 772 Kalua

Ua koi mai ia no kona ^{mau} wahi ma Kamakela i Honolulu Aina, maha Moku o Oahu; no ka mea, ua loa ia ia heia mau wahi no ka wa o Kaahumanu a me ka wa ia Kaomi, no Kamahalo ma ke Kalauna Aina Kalo, a no Kanua mai hoi ka pahale. Ua hekeia nae o Maku i ka pahale, molaila, ua makoleia e na Lina ua pala a kaawale ke Kalua a me Maku, a ua noho hea hea hou oleia mai a hiki i heia mauwa.

Oia ka makou e hoko nei nei no Kalua; he kuleana hoi kona malalo o ke Awa Alodio. Ina e utu mai oia i ke ke Aupuni he pahale; alaila, ua kupaia ia ka Palapala Awa Alodio.

Pono nae ia na ke utu no ka hoko kolo a me ka hoko ana i ka olelo. Penei:-

M. M.	No ka nui a me ke hoi ana i ka olelo ma ka Mapepa.	\$ 1 -
G. M. Robertson	No ke kope ana i ka olelo koina	50
	No ka palapala kii.	50
J. H. Smith	No ka hoi ana i ka olelo 20 o Maraki 1847.	1 -
	No ke kope ana i na olelo a na hoi	75
J. Hekeulahan	No ke ana ana i ka olelo 3 o October 1851.	4 -
J. M. L.	No ke kope ana	50
J. M. L.	No ka hoko ana i ka olelo, August 21, 1852.	2 50
		<u>\$ 10.75</u>

Eia na fulena. Inaia o A. F. Turner.

Ahana 1. Pahale ma Kamakela i Honolulu Aina, Oahu.

E hoomaka ana ma ke kiki Aka, a e holo ana

Kema	58 1/2	Hikina	50	pauna e pili ana i ke Aupuni
Kema	45	Komohana	97	" " " Maku
Akau	54	Komohana	47	" " " Kahu-omoo
Akau	44	Hikina	93	" " " Wahi

i ke kiki mua.

O. 0456 Eka

Ahana 2. Loo Kalo ma Kamakela i Honolulu Aina, Oahu.

E hoomaka ana ma ke kiki Kema, a e holo ana

Akau	46 1/2	Hikina	53	pauna e pili ana i ke Kalo
Akau	43	Komohana	198	" " " "
Akau	59	Komohana	133	" " " "
Kema	19	Komohana	114	" " " Aala
Kema	74	Hikina	149	" " " Kapi
Kema	46	Hikina	144	" " " Kalua

i ke kiki mua.

O. 32208 Eka

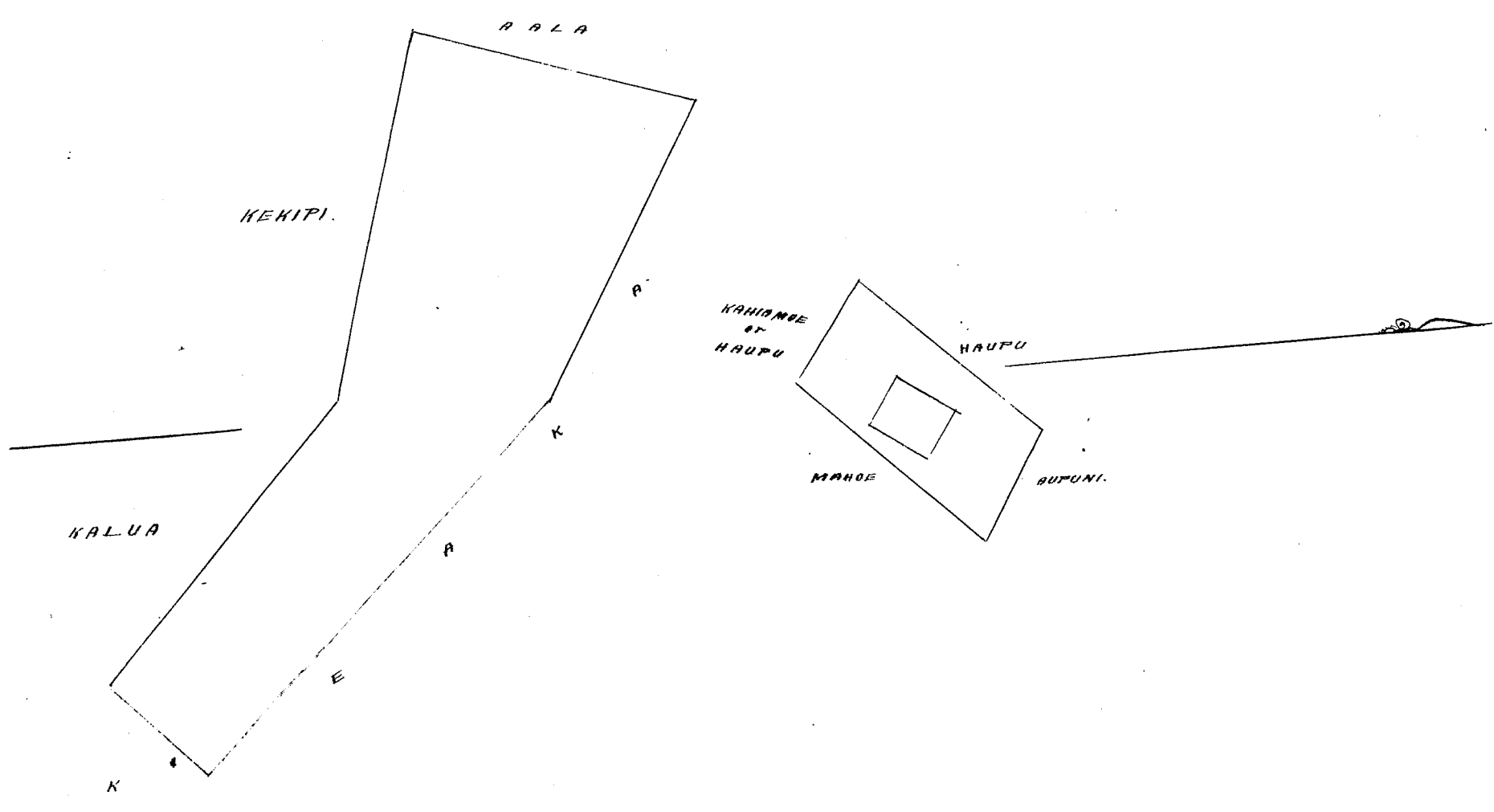

Ua koi mai oia mo kona wahi ma ke Kulanakauhale o Honolulu ma ke Mokupuni o Oahu; ma ka mea, ua loa ia ia keia wahi no Kekaulike mai i ka manawa i hoo kolo kolo ia i Rev. Wth Richards i kahi huale i hoo haamaale ai ia mau, a ua noho keakea oleia a hiki i keia manawa.

Oia ka makou e hooke nei no Josua Kaco, ke kuleana hoi kona malalo o ke Anu Aloha. Ima e nku mai oia i ke ke Aupuni hapaha; alaila, ua kupono ia ia ka Palapala Ila Aloha.

		#	Ken.
	No ka sumi a me ke faai ana i ka olelo ma ka Mupapa.	1	-
	No ke kope ana i ka olelo koina		50
G. M. Robertson	No ka palapala kii		50
W. H. Lee	No ka hana ana i ka la 16 o Sepatemaba 1846.	1	-
S. H. Lanika	No ka kope ana i na olelo aua hoike 1/2 Awa		50
J. Kewaulaha	No ke ana ana i ka la 30 o Augate 1852.	2	-
	Apaia e No ke kope ana		50
Joune Li	No ka hoo holo ana i ka olelo Sepatemaba 1, 1852.		2 50
			<hr/>
Oia na palena. Anua e S. Kalamo			\$ 8 50

Pahale ma Honolulu Kulanakauhale, ma Oahu.
 E hoomaka ma ke kahi Akau maunaka e pili ana me ke Alamii Maunakea a me ke Pahale o Paniani, a e holo oena 41° Kite. 30 Puntur pili ana me ke Paniani a hiki i na kahi o ke Kaluatiwenui a me ke Mahana. - Alaila oena 1° Kaul. 38 Puntur, pili ana me ke Mahana a hiki i ka pa o Kaaha i lilo ia Kaikuna (Tyhonu) - Alaila oena 60° Kom. 2 1/2 Kaulaha ma ke Kaikuna a hiki i ke Alamii Alii. - Alaila Akau 37° 30' Kom. 1 Kaul. 30 Puntur ma ke kahi maunaka o ke Alamii Alii a hiki i ka huina me ke Alamii Maunakea. Alaila Akau 48° Kom. 3 Kaulaha me 30 Puntur e pili ana ma ka kahi oena o ke Alamii Maunakea a hiki i kahi i hoomaka i.

Ka Ii 596 Anana.

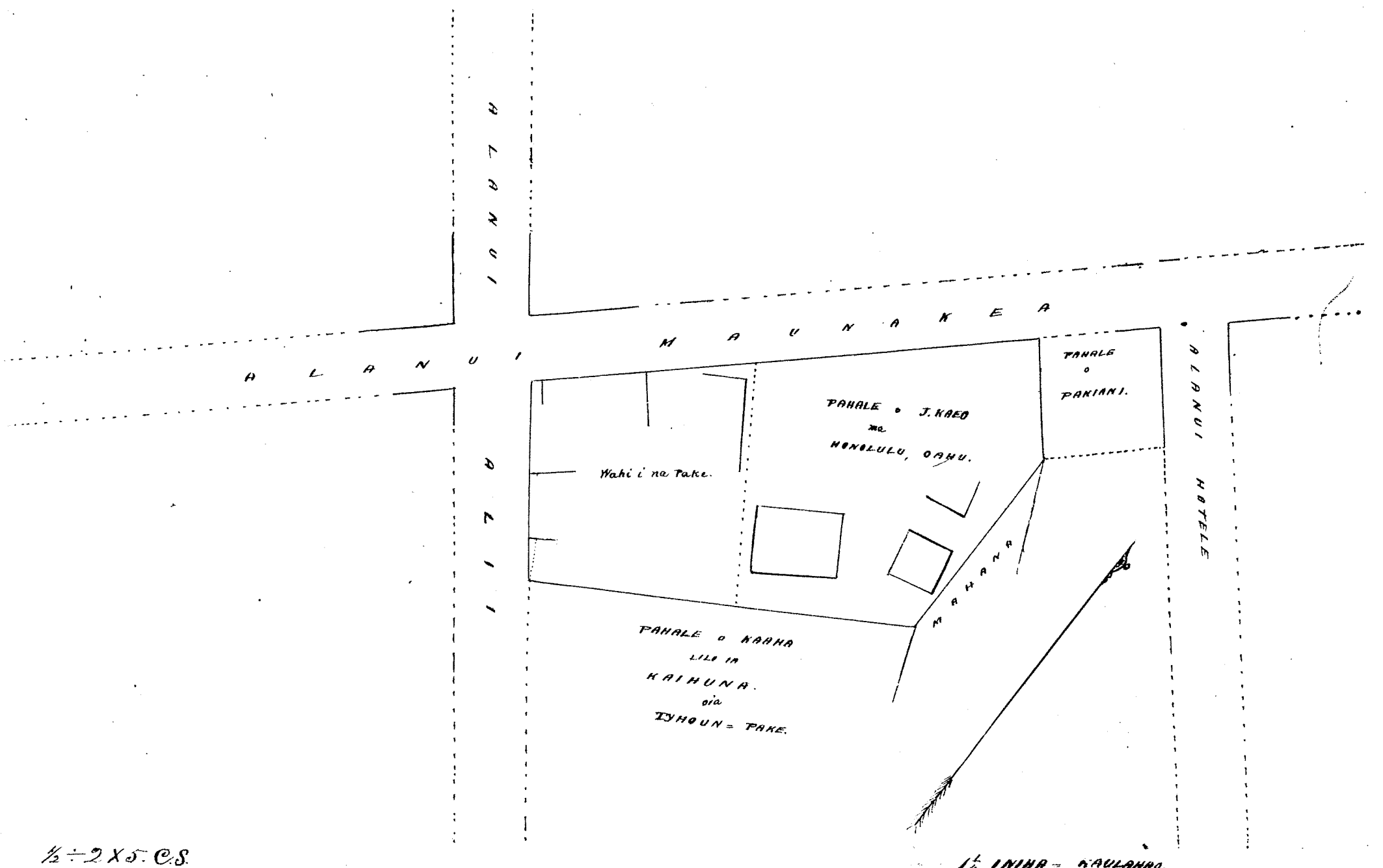

1/2 x 25. C.S.

1/2 ININA - KAULAHAA.

Kelu 3149 Namokueha

Ua hui mai oia no kōna wahi ma Hewalo i Honolulu Uina, ma ka Moku o
 Oahu; no ka mea, ua loa ia ia keia wahi no Kaaimahui mai kana waiho, aua loa hoi ia
 Kaaimahui no Waianua mai kana kame mua, a ua loa hoi ia Waianua i ka wa o Kaakumama 1.
 a ua noho keakea oleia a hiki i keia manawa.

Cia ka makou e hooko nei no Namokueha; he kule ana hoi kana malalo o ke
 Alo Alodis. Ina e ulu mai oia i ke Alo Alodis hapaha; alaila, ua hooko ia ia ka
 Palapala Alo Alodis.

Pono nae iana ke ulu no ka hookokolo a me ka hookolo ana i ka olelo. Penei:-

		\$ Cen.
W. M.	No ka mumi a me ke fai ana i ka olelo ma ka Muepa.	1
G. M. Robertson	No ke kope ana i ka olelo kōma No ka palapala kōma	50 50
J. H. Smith	No ka kama ana i ka la 20 o Novemaba 1851	1
J. Kekaulahao	No ke kope ana i na olelo a ma hōke 1/2 Aoro No ke ana ana i ka la 6 o Dekemaba 1851, Ukuia \$6.-	50
L. M. S.	No ke kope ana	50
	No ka hookolo ana i ka olelo, Sepatemaba 1, 1852.	2 50
		<u>\$ 6.50</u>
Cia na palena.	Anaia e S. P. Kalamā	

Aina Kalo ma Hewalo Ii i Honolulu, Uina.

E hōmaka ana ke kiki Kikina mauka o keia aina, e fili ana me ke Naone
 a me ke Mahina, a e holo Kōma 40 Kom. 120 Kapuai ma ke Mahina kiki a hiki i
 ke kiki Kōma o keia aina, - Alaila e holo 62 Kom. 225 Kapuai ma ke kōle a hiki i ke
 Naone, - Alaila e holo 46 1/2 Hik. 96 Kapuai ma ke Naone a me kōle a hiki i ke Naone,
 Alaila Kōma 51 Hik. 116 Kapuai kiki, a e holo 43 Hik. 38 Kapuai kiki, a e holo 58
 Kom. 110 Kapuai a hiki i ke kōle, a e holo 49 1/2 Hik. 57 Kapuai ma ke kōle a hiki hoi i
 ke Naone, - Alaila Kōma 53 Hik. 104 Kapuai, a e holo 35 Hik. 92 Kapuai ma ke
 Naone a hiki i kahi i hōmaka i

807 Anana, 27 1/2 Kapuai.

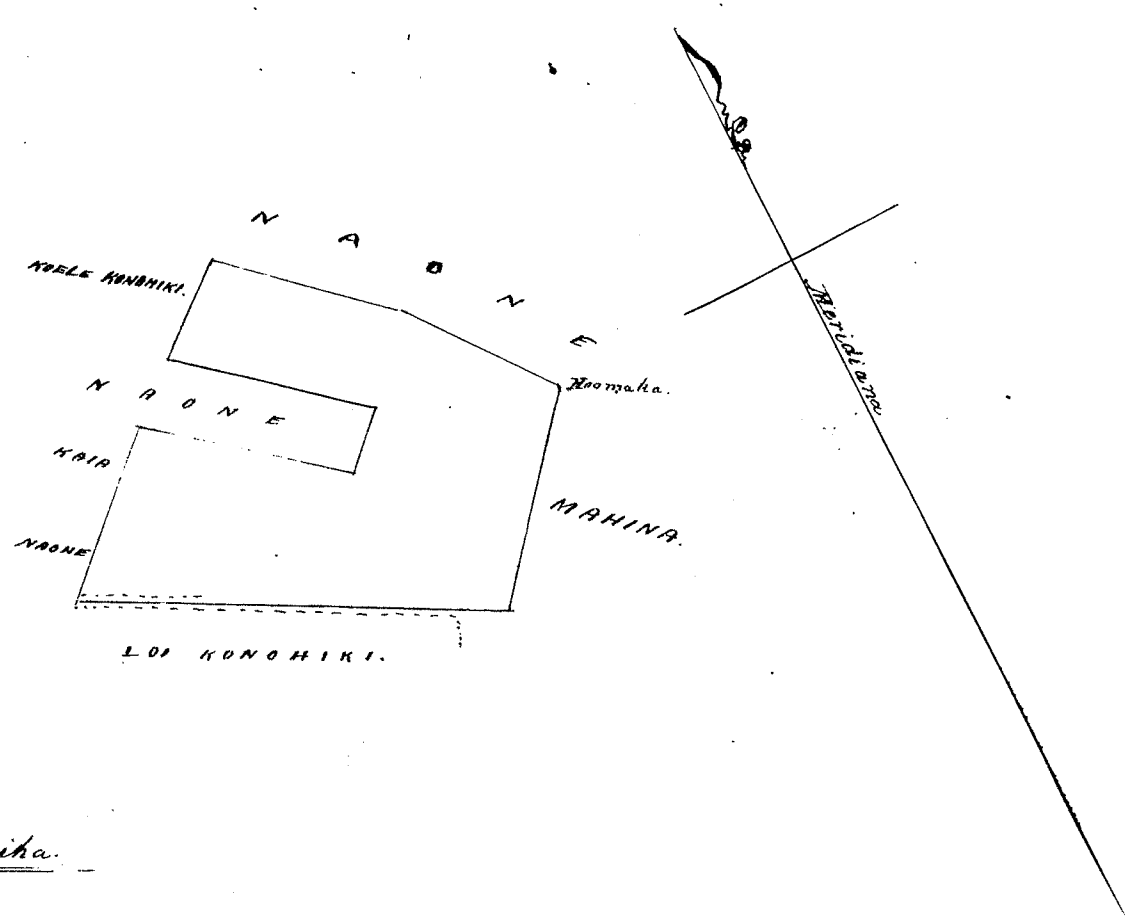

Ana 50 Kapuai 1/2 Iuka.

Ua koi mai oia no kona wahi ma Kikihale ma ke Kulanakauhale o Honolulu, ma ke Mokupuni o Oahu; ma ka mea, ua loa ia ia keia wahi no Kaihana mai kana kane mua i ka wa o Liholilo, a ua noho keakea oleia a hiki i keig manawa.

Ua ka makou e hooke nui no Kahomana; he kuleana hoi kona malalo o ke Aho Abdio. I na o uku mai oia i ke ke Opuni hapaha; alaila, ua kupo ia ia ka Palapala Pila Abdio. I na oia ia ke uku no ka hoholo oia ma ke hoholo ana i ka olelo. I na oia:

		\$	Ken.
W. Lee	No ka nui a me ke pua ana i ka olelo ma ka Kupuha.	1	-
G. M. Robertson	No ke kope ana i ka olelo koina.		50
	No ka palapala kii		50
W. Smith	No ka hana ana i ka la 13. I Decemaba 1851.	1	-
	No ke kope ana i na olelo i ia hiki 13 Awa		50
J. Kaulahao	No ke ana ana i ka la 20 i Decemaba 1851. Ukuia ke ana 1/3.		
Louise Li	No ke kope ana		50
	No ka hoholo ana i ka olelo I Sepatemaba 1, 1852		2 50
		<u>\$</u>	<u>6.50</u>

Eia na palena. Anai i S. Kalamo

Kuleana Pahale Kahomana ma Kikihale i Honolulu Kulanakauhale, Oahu.

E hoomaka ma ka pahu i kuniia i ka huiwai omole ma ka pa o Koolili-amanu a me ke kiki Koomohana makai o ke Opuni Pahale, a e hoi ma ke Opuni Aka 75. I ka 144 1/2 Pahu a hiki i ke kiki o ka pa o Kaapuni, - Alaila Aka 65. I ka 27 Pahu ma ke Kaapuni a hiki i ke Kanihu, ke kiki Kikina makai o keia pa; Alaila Aka 24 Kom. 9 Pahu ma ke Kanihu pa a hiki i ke Kawewela; Alaila Aka 58 Kom. Aka 70 Pahu, Aka 70 Kom. Aka 1 1/2 Kapua i ka ana ana o keia pa; ma 113 Pahu, Aka 70 Kom. Aka 1 1/2 Kapua i ka ana ana o keia pa makai i ke na Lanu Koa. 113 Pahu, - Alaila Aka 56 Kom. 73 Pahu ma ke Kawewela pa a hiki i ka pahu ma ka pa o Kooliliamanu, - Alaila ma ka pa o Kooliliamanu he 45 Pahu a hiki i ka hiki i hoomaka i.

Ma na Pahale 149 Aka.

Ma ka Pahu Hookahi 7.92 Iuka
Ma ke Kaulahao 100 Pahu, - 66 Kapua oia

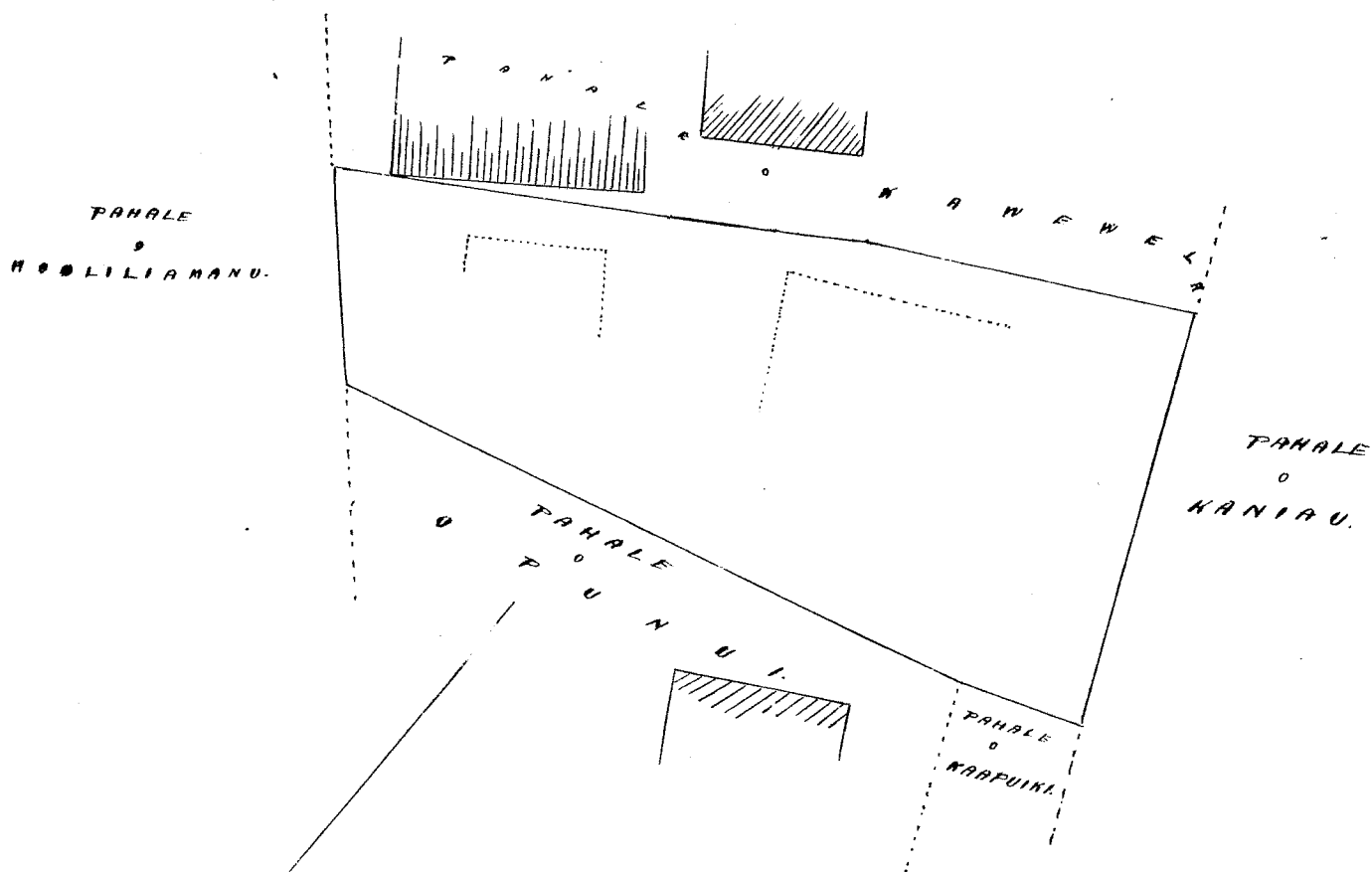

2 1/2 Iuka - Hookahi Kaulahao.

Hele 2072 Kapahua

Ue koi mai oia no kona mau wahi ma Kapahua i Honolulu Aina, ma ka Moku o Cahu; no ka mea, ua loa ia i ka mau wahi no Kaumealani mai ke Konoehiki i ka makahiki 1835, a ua wahi keakea oia a hiki i keia manawa. Oia ka moku e hoko nei no Kapahua, ke kuleana hoi kona malalo o ke Ano Alodiv. Ima e uka mai oia i ke Moku o Kapahua; alaila, ua kufono ia ia ka Palapala Sila Alodiv.

Iono nae iaia ke uka no ka hoholo ana oia me ka hoholo ana i ka olelo. Penei;—

		\$	Ken.
W. H. W.	No ka rumi a ma ke pui ana i ka olelo ma ka Mapepa.		1 -
G. M. Robertson	No ke kope ana i ka olelo koina		50
	No ka palapala kii		50
J. H. Smith	No ka hana ana i ka haka 3 o Iulai 1837. —		1 -
	No ke kope ana i na olelo a ma hoi ke 1/2 Awa.		75
J. Kakaiahao	No ke ana ana i ka la 29 o October 1837.		6 -
Loani	No ke kope ana		50
	No ka hoholo ana i ka olelo, Sepatemaba 1, 1832.		2.50
Eia na palena. Anai e A. F. Turner.		\$	12.75
		Eni	2.75
		\$	10.00

Apana 1. Pahale ma Kapahua i Honolulu Aina, Cahu.

E hoomaka ana ma ke kiki Aka, a e holo kema 47° Hoi. 452 fuanuku e pili ana i ke Alanui Aupuni; — Kema 62° Ho. 239 fuanuku e pili ana i ke Uluwa, — Kema 27° Hoi. 80 fuanuku e pili ana i ke Uluwa, — Kema 68° Ho. 337 fuanuku e pili ana i ke Kapahu, — Aka 30° Ho. 115 fuanuku e pili ana i ke Kapahu, — Aka 69° Hoi. 161 fuanuku e pili ana i ke Kaluan, — Aka 34° Ho. 295 fuanuku e pili ana i ke Kaluan, — Aka 46 1/2° Hoi. 312 fuanuku e pili ana i ke Kaluan i ke kiki mua.

1 1/10 Eka.

Apana 2. Ioi Kalo & Kahuahale ma Kapahua

E hoomaka ana ma ke kiki Kema, a e holo ana Aka 20° Hoi. 179 fuanuku e pili ana i ke — Aka 41° Ho. 190 fuanuku e pili ana i ke Heho. Kema 52° Ho. 50 fuanuku e pili ana i ke Opuni; Kema 44 1/2° Hoi. 90 fuanuku e pili ana i ke Wahineokapiki; — Kema 57° Ho. 165 fuanuku e pili ana i ke Wahineokapiki; — Kema 54° Hoi. 195 fuanuku e pili ana i ke Alanui Aupuni i ke kiki mua.

3/10 Eka

Apana 3. Ioi ma Kapahua

E hoomaka ana ma ke kiki Kema, a e holo ana Aka 41° Ho. 114 fuanuku e pili ana i ke Alanui Aupuni; Aka 53° Hoi. 232 fuanuku e pili ana i ke Heoni Ana; — Kema 36° Hoi. 114 fuanuku e pili ana i ke Kalo; — Kema 53° Ho. 220 fuanuku e pili ana i ke Opuni i ke kiki mua.

4/7 Eka

1.60
30
25
2.75

ALANUI AUPUNI.

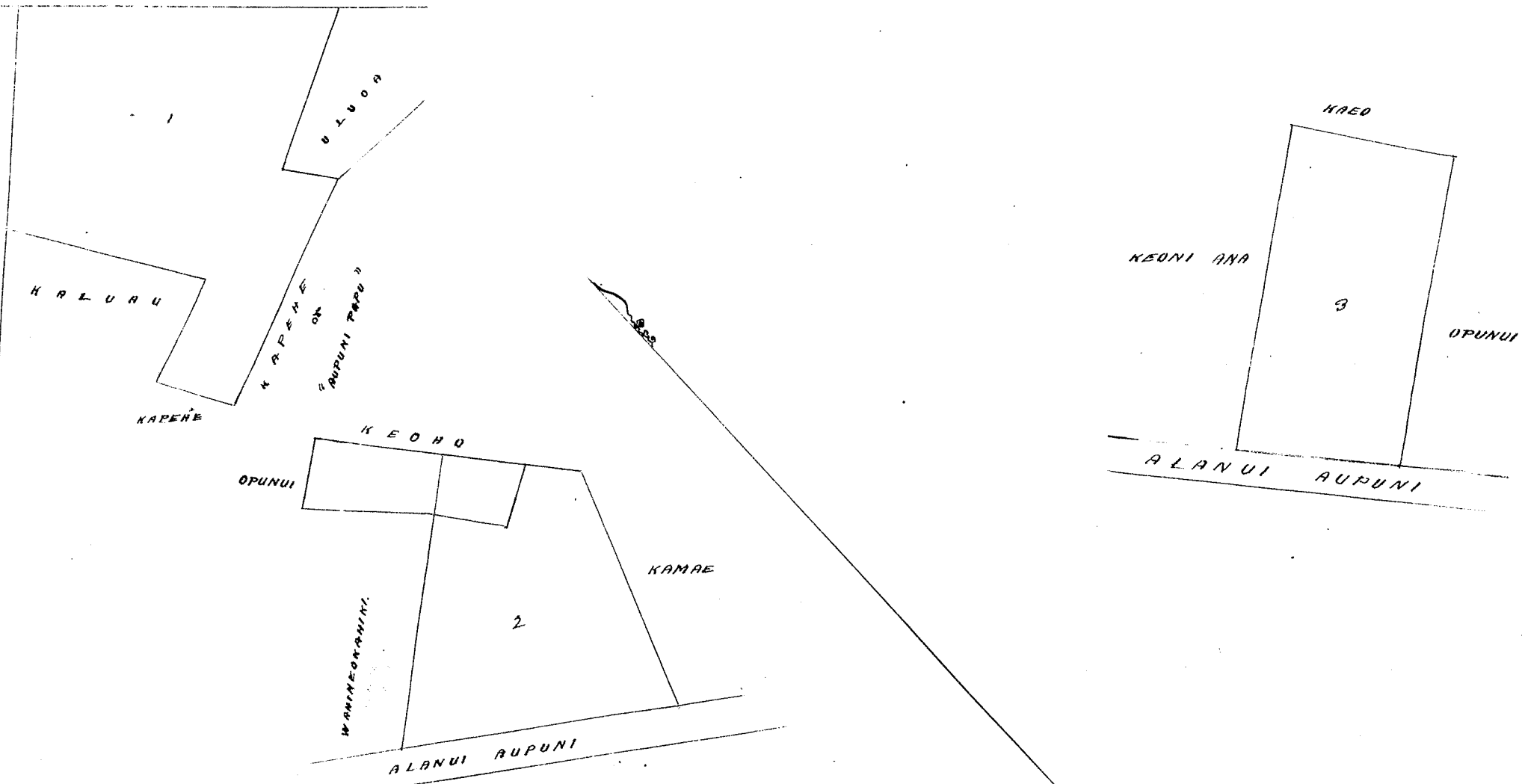

Ua koi mai oia no kona mau wahii ma Kewalo i Honolulu ma ka Mokupuni o Oahu; no ka mea, ua kōia ia ia keia waiki no Tona Pahu mai i ka makahiki 1847. - a ua noho keakea oleia a hiki i keia manawa.

Oia ka maku i hōkō nei no Pahua; he kuleana hoi kona malalo o ke Awa Aloha. Ima e uku mai oia i ke ke Kupuni hōpaha; alaila, ua kōpua ia ia ka Palapala Pū Aloha.

Tono ma ia ia ke uku no ka hōkō kōlo a me ka hōhōlo ana i ka olelo. Ima,

Ken.

M. Lee

No ka nūmi a me ke fua ana i ka olelo ma ka Pūpū.

G. M. Robertson

No ke kōpe ana i ka olelo kōma

No ka palapala kōi

M. S. Smith

No ka hōma ana i ka la 29 o Septemala 1848.

No ke kōpe ana i ma olelo a ma hōhōlo 1/2 Awa

J. H. H. H.

No ke ana ana i ka la 11 o Aperila 1850

Loome de No ka hōhōlo ana i ka olelo. Septemala 6, 1852.

Uku fua low \$ 500

Oia ma palua.

Arava o A. S. Thurston

Pahua o Pahua ma Kewalo, Honolulu, Oahu.

E hōmaka ma ke kōi Aha maaka o keia ma ka fua ana pūi ana me ke Pūa fakala. U. e holo ana Kōma 63° 45' Hōi. 3, 53 kaul. ma ka Pūi, hiki i ka pōhaku ma ke kōi Kōma maaka o keia pūi ana me ka fakala o Kōma kōpōli; - Kōma 34° 30' Hōi. 3, kaul. ma ka Kōma kōpōli, hiki i ka pōhaku ma ke kōi Kōma maaka o keia, pūi ana me ka ana o Kōma kōpōli Aha 60° Hōi. 3, 18 kaul. ma ka Kōma kōpōli, hiki i ke kōi Aha maaka o keia pūi ana me ke Pahua fua, Aha 27° 15' Hōi. 2, 80 kaul. ma ke Pahua a hiki i ka hōi i hōmaka i.

Ma ia Aha

1174 Arava

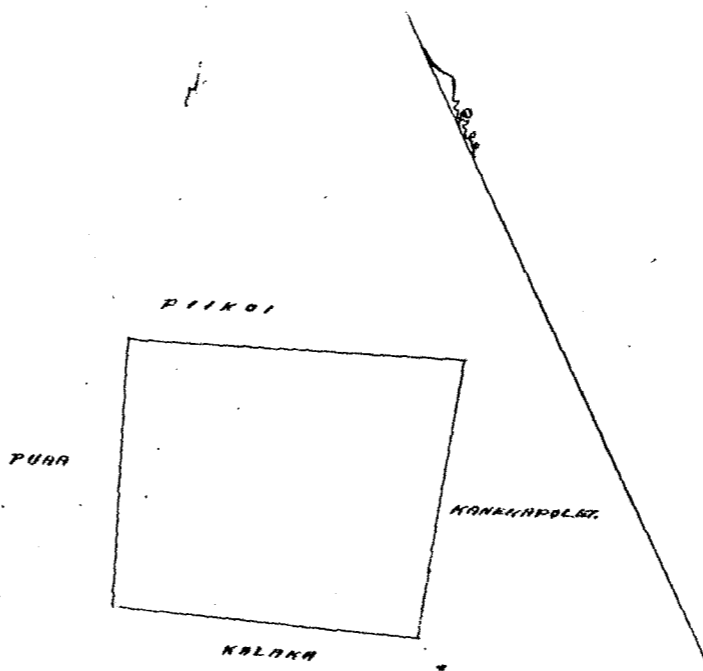

1/2 e. s.

Hele 3911 Tale (no Kapohaku)

Ua koi mai oia no kona wahi ma Auwailinu i Honolulu Aina, ma ka Moku o Oahu; no ka mea, ua loau ia ia keia wahi no Heawehewa mai i ka makahiki 1847, a ua noho keakea oia a hiki i kona make ana i ka makahiki 1850, a haawi i keia wahi ia Parakahi ka Laka o Honolulu, a na Parakahi i haawi lilo loa aku ia Kapohaku, a ua noho keakea oia mai ia manawa mai a hiki i keia manawa.

Oia ka makou e hoohe nei no Tale; he kuleana hoi kona anatala o ke Aho Alodio. Ana e uku mai oia i ke ke Aupuni kapaha; alaila, ua kupo ia ia ka Palapala Hele Alodio.

Pono nua ia ia ke uku no ka hoohelele a me ka hoohelele ana i ka olelo. Poni,

	No ka nuni a me ke fai ana i ka olelo ma ka Moku	\$ 1 -
	No ke kope ana i ka olelo koina	50
G. M. Robertson	No ka palapala kii	50
W. L. L.	No ka huna ana i ka la 12 o Aperila 1851.	1 -
J. H. Smith	No ke kope ana i na olelo a na hoiho 1/3 Aho	50
	No ke ana ana i ka la 3 o Novemaba 1852.	2
J. Kekaulaha	No ke kope ana	50
J. J. J.	No ka hoohelele ana i ka olelo, Heptemaba 7, 1852.	2 50
		<u>\$ 8 50. -</u>

Oia na palena. Aina e A. H. Turner.

Hele 3911 ma Auwailinu i Honolulu Aina, Oahu.

E hoomaka ana ma ke kiki Heema, a e holo

Akua	74°	Heema	180	puuku e fili ana i ke Paka
Akua	52°	Heema	180	" " " " Heema
Akua	19°	Komohana	5	" " " "
Heema	73°	Komohana	349	" " " " Kahawai
Heema	19°	Heema	60	" " " " Kapena.

i ke kiki ana.

0. 17464 Eka.

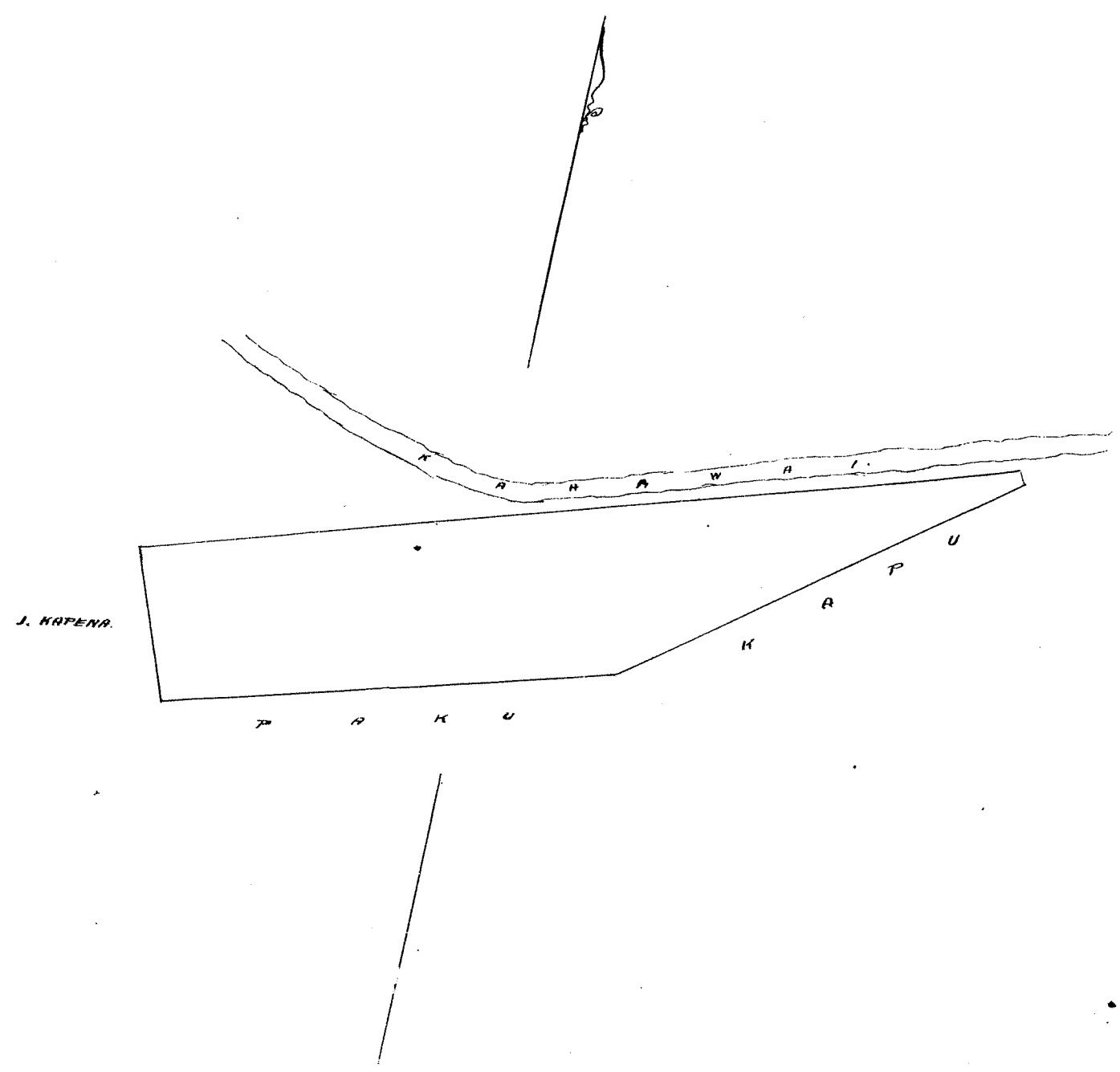

Ua hoi mai oia no kona wahi ma Kapehuna i Honolulu ma ka Mokupuni Oahu, me ka
onea, ua loaa ia ia keia wahi no Kaipuhaa mai i ka wa o Peki, a ua noho keatea oia a hiki i
keia manawa.

Oia ka wahi e hooke nei no Apui; he kuleia hoi kona malalo o ke Ano Alodi.
Ia e hooke mai oia i ke ke Anupuni hapaha; alaila, ua kope ia ia ka Palapala Ila Alodi.
Ia e hooke mai oia i ke ke hooke nei no ka hooke kolo a me ka hooke ana i ka olelo Penci;—

- W. P. Lee No ka oomi a me ke pui ana i ka olelo ma ka Anupuni.
 - G. M. Robertson No ke kope ana i ka olelo koina
 - V. H. Smith No ka palapala kii
 - J. K. Kaula No ka hana ana i ka la 18 o Aperaha Augate 1852.
 - J. K. Kaula No ke kope ana i na olelo a me ke hooke i Oahu
 - J. K. Kaula No ke ana ana i ka la 30 o Augate 1852.
 - J. K. Kaula No ke kope ana
 - J. K. Kaula No ka hooke ana i ka olelo Sepatemaba 11, 1852.
- Oia na palena. Anaia i S. Kalama Paulon. \$ 5.00

Elua Loi ma Kapehuna i Honolulu, Kona, Oahu.

E hoomaka ma ke kahi Kona o keia manawa e pili ana me ke Kealahipali
a me ke Limaiika. A e hooke Akua 35 Homohana, 288 Panku ma ke Kealahipali a me ke Konaiale
a hiki i ke Nahala. — Alaila Akua 53 Hikina 123 Panku me ke Nahala a hiki i na kahi o Akoni
a me Kamohaike. — Alaila Akua 33 1/2 Hikina 287 Panku, kahi, a Kona 52 Homohana Kaula
pili ia mau ana me Kamohaike a me ke Limaiika a hiki i kahi i hoomaka i
Ma keia Ana 32/100 Eka.

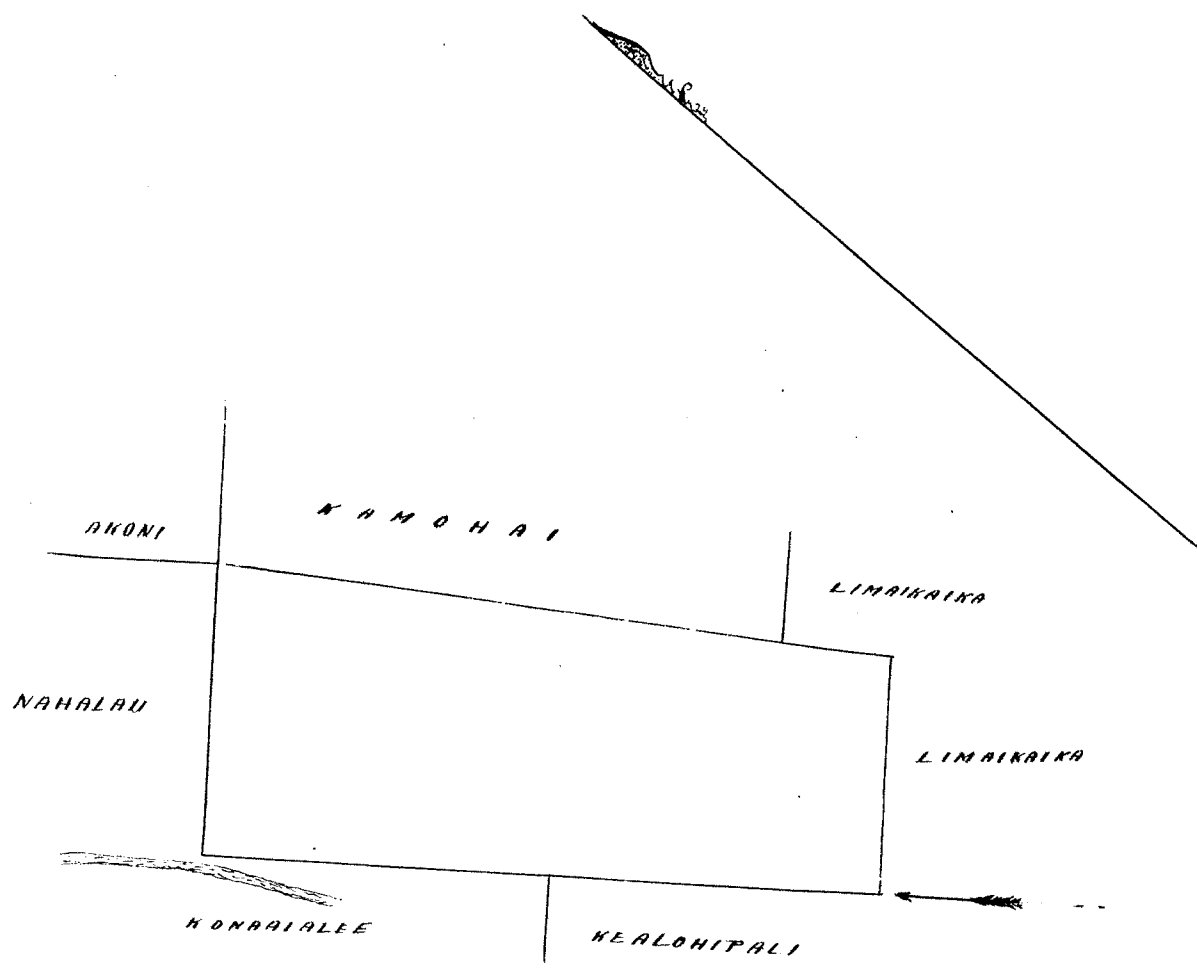

1/2 ÷ 2 x 5. C.S.

3/4 INIHA KAUANAO

Kelu 2166 Waialeale (no Kalakua)

Ua koi mui oia no kona mau wahi ma Kauluvela i Honolulu Oia ma ka Mokupuni o Oahu, no ka mea, ua loa ia ia keia mau wahi no Kalakua mai i ka makahiki 1846, a noho keakea oia a hiki i kona make ana i ka makahiki 1850, a lilo hou no ia Kalakua mai ia wa mai, a ua noho keakea oia a hiki i keia manawa.

Oia ka mukou e hooke nei no Waialeale, he kuleana ho'i kona matalo o ke Ano-Abdio, Ina e uku mai oia i ke ke Aupuni hapaha, alaila, ua kupo no ia ia ka Palapala Ika Hodia. Ione nae ia ia ke uku no ka hookelelele a me ka hookele mai i ka olelo. Penei,

M. M. Ke
 G. M. Robertson No ka kope ana i ka palapala keia. \$ 500
 J. H. Smith No ka palapala keia
 J. Kapaunahoa No ka hana ana i ka la 26 o Augate 1851.
 Isaac L. No ke kope ana i na olelo a mahi i ke 1/3
 No ke kope ana i ka la 30 o Octobe 1851.
 No ka hookele ana i ka olelo 10 o Septemaba 1852.
 Eia na pulena. Anai e A. J. Turner. Pulena \$ 8 00

Apana 1. Pahale ma Kauluvela, Honolulu Oia, Oahu.

E hoomaka ana ma ke kiki Akau, a e holo ana

Hema	48°	Komohana	59	pauna,	e pili ana i ke Kaiwe
Hema	52°	Hikina	216	"	"
Hema	35°	Komohana	144	"	"
Hema	2°	Komohana	77	"	"
Akau	85°	Hikina	121	"	"
Akau	8°	Hikina	166	"	"

i ke kiki mua. $\frac{3}{10}$ Eka.

Apana 2. Loi Kalo ma Kauluvela, Honolulu Oia, Oahu.

E hoomaka ana ma ke kiki Akau, a e holo ana

Hema	63°	Hikina	792	pauna	e pili ana i ke ke Kauhiki
Hema	42°	Komohana	78	"	"
Akau	77°	Komohana	30	"	"
Hema	44°	Komohana	53	"	"
Akau	47°	Komohana	71	"	"
Hema	55 1/2°	Komohana	50	"	"
Akau	63°	Komohana	661	"	"
Akau	28°	Hikina	168	"	"

i ke kiki mua. $1 \frac{1}{4}$ Eka.

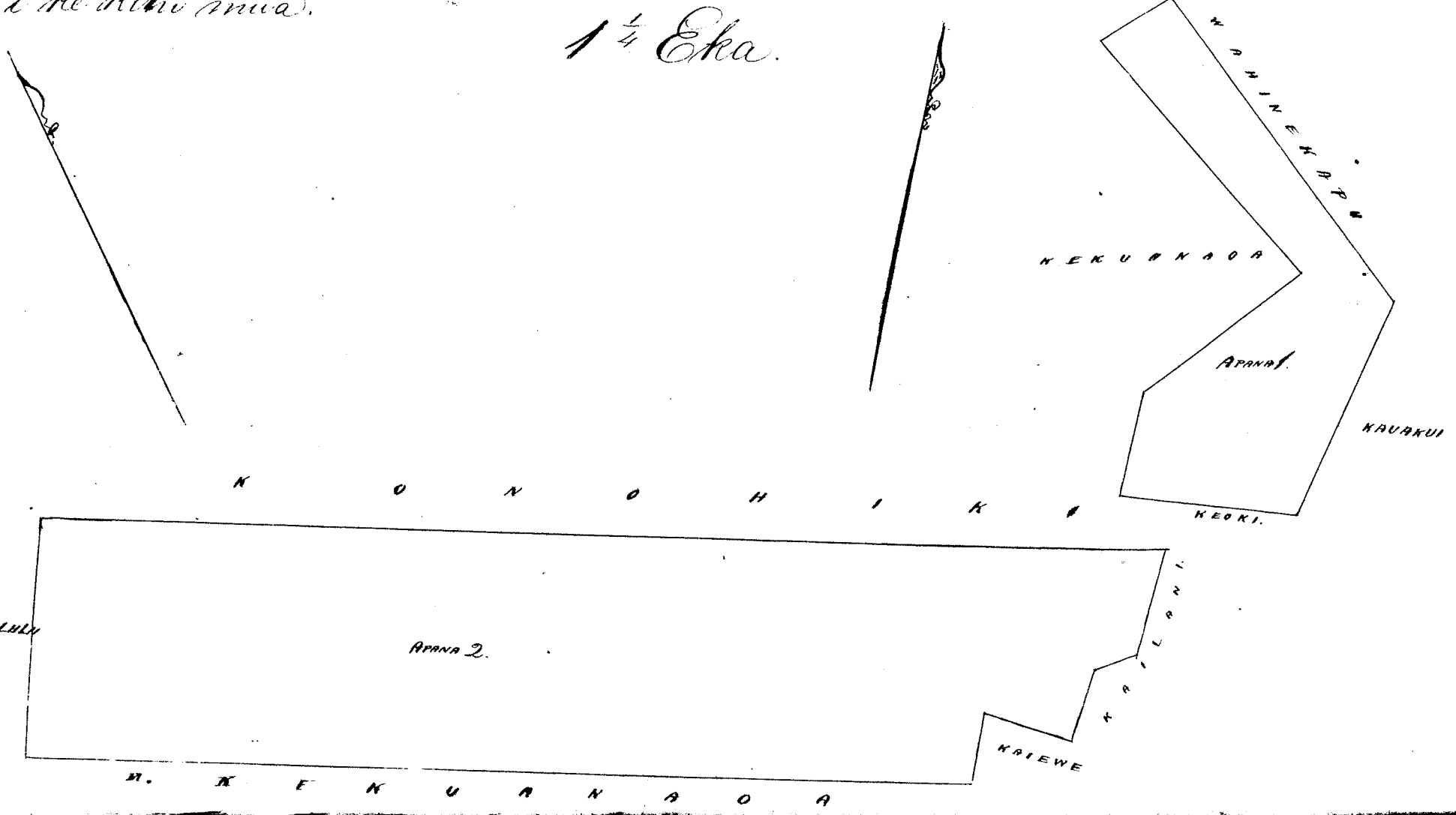

Ua koi mai oia no kona wahi oia Kaula i Honolulu oia ma ka Mokupuni o Oahu, no ka mea, ua loaa ia i keia wahi no Kalakua mai i ka makahiki 1846, a ua noho keakea oia a hiki i keia manawa.

Oia ka makou e hooke mai no Kaitani; he kuleana hoi kama malalo o ke Aunui oia; Ana e utu mai oia ike ke Aunui hapaha, a hoi, ua kupa no ka Palapala oia Alodiv op, Iano ma ia ia ke utu no ka hooke holo a me ka hooke ana i ka olelo. Ianei,

- W. Lee No ka nuna a me ke ke paia ana i ka olelo ma ka Muepa. # Hen.
- G. M. Robertson No ke kope ana i ka olelo kama
- J. H. Smith No ka palapala kii
- J. H. Kaula No ka hana ana i ka 2. Januari 1850 & Augate 21, 1851.
- Loane Si No ke kope ana i ka olelo a ma hoi ke 2/3 kava
- No ke ana ana i ka 30. October 1851.
- No ke kope ana
- No ka hooke ana i ka olelo, Sepatimata 10, 1852. Pauba # 5.00

Oia na palua. Anaia e A. S. Turner.

Pahale a me Kula ma Kaula, Honolulu, Oahu, Oia.

E hoomaka ana ma ke kiki Kama, a e holo

Hele	Hele	Hele	Hele	Hele	Hele
Akau	44°	Kikina	162	paaku e pili ana ike	Wahinekafe
Akau	48°	Komohana	110	"	"
Kama	42°	Komohana	78	"	"
Akau	77°	Komohana	30	"	"
Kama	44°	Komohana	53	"	"
Kama	40°	Kikina	130	"	"

Ma i ke kiki oia 1/5 Eka.

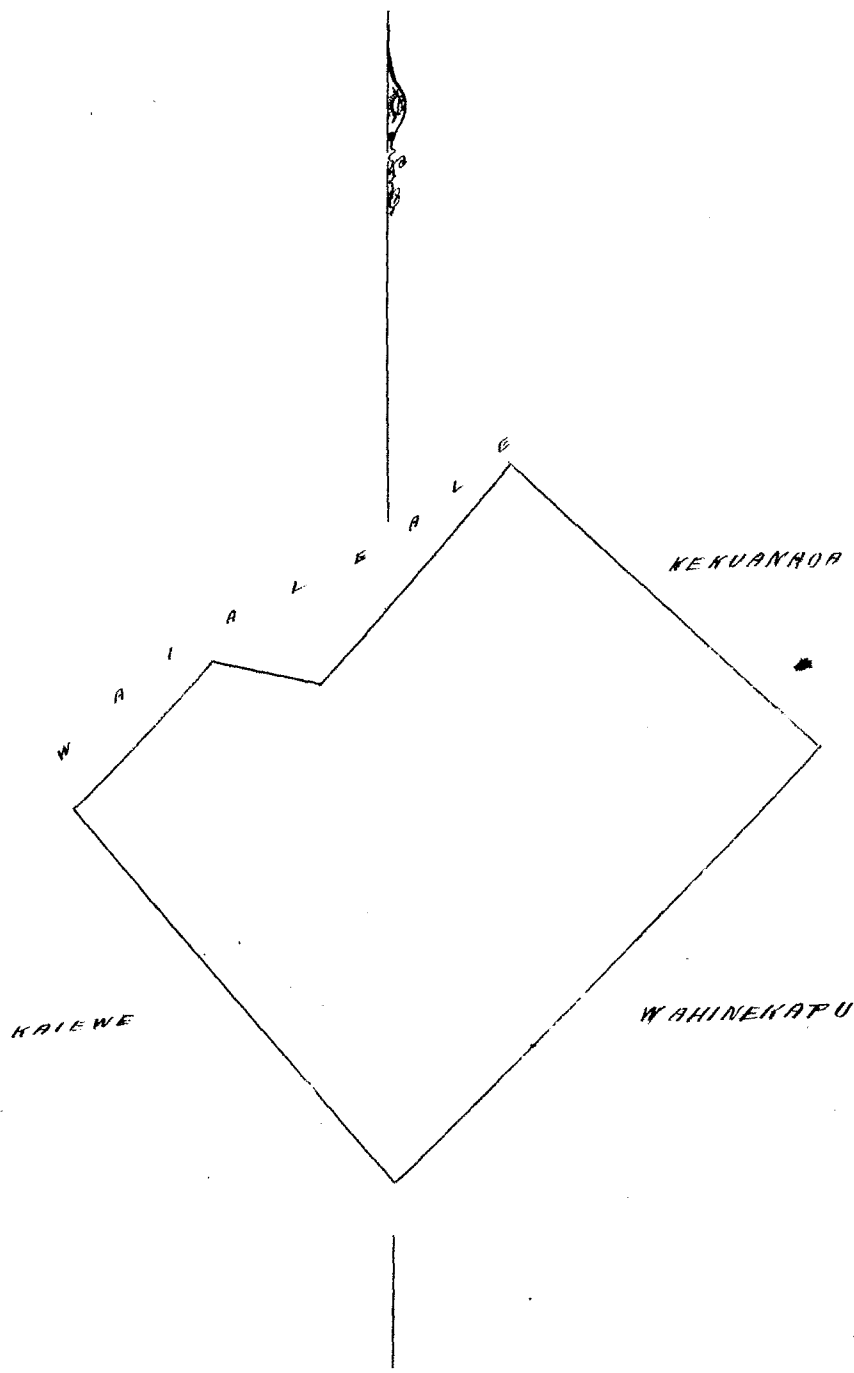

Heleu 3702 & 5410 Davida Malo

Apana 3

Ua koi mai oia no koma mau wahi ma Ukumehame ma ke Mokupuni o Maui; no ka mea, ua loa ia ia keia mau wahi no kana wahine mai, a ua loa hoi i kana wahine no ka wahine mai a Pikanalo ke honohiki i ka makahiki 1832, a ua noho keatea oia a hiki i keia manawa.

Oia ka makou e hooke nei no Davida Malo; ke kuleana hoi koma ma ke Ano Alodio

Tou mae ia ia ke wahi no ka hookekele a ma ka hookekele ana i ka olelo. Penei

- W. A. Hele No ka nani a me kepai ana i ka olelo ma ka Mapepa
- G. M. Robertson No ke kope ana i ka olelo koma
- J. K. Smith No ka palapala kii
- J. K. Smith No ka hana ana i ka la 19 o June 1849.
- J. K. Smith No ke kope ana i ma jole a ma hiki
- J. K. Smith No ke ana ana i ka la o Mar. 1851. Ukuia
- J. K. Smith No ke kope ana
- J. K. Smith No ka hookekele ana i ka olelo Lepatunaba 14, 1852.

Ken.

Eia na palapala. Ania i L. P. Wa.

10.00

Ke ana ana i kekahi man Apana aia o D. Malo ma ke Ahupuaa o Ukumehame ma ke Mokupuni o Maui.

Apana II. He ana kolo ma ka ili o "Chiaiki". E hoomaka ma ke kiki Heema Komohana o keia aia ma kahi e pili ana i ka pali a me ke Kealo, a e holo ana

Akau	83 1/2	Hikina	0. 63	Kaula ma ke Kealo
Akau	75 1/2	Hikina	0. 73	"
Akau	44	Hikina	1. 15	"
Akau	23 1/2	Hikina	1. 62	" a hiki i ke kahawai.
Akau	16	Komohana	1. 65	" kahawai
Akau	64 1/4	Komohana	2. 40	"
Heema	31 1/2	Hikina	0. 77	" a hiki i ka pali
Heema	6 1/2	Hikina	2. 21	" pali
Heema	12 1/2	Komohana	1. 70	"
Heema	34 1/2	Komohana	0. 82	"
a hiki aku i kahi i hoomaka ai.			Ka ili	2 Roda 20 Roda.

Apana III. Eia Loi. E hoomaka ana ma ke kiki Komohana o keia aia ma kahi e pili koke ana i ka auwai a me ke kula, e holo ana;

Akau	37	Hikina	2. 14	Kaula ma ke kula
Heema	65	Hikina	0. 23	" ke Kaper
Heema	30 1/2	Komohana	0. 45	" ka auwai
Heema	42 1/2	Komohana	1. 73	"
Akau	55	Komohana	0. 19	" ke kula
a hiki i kahi i hoomaka ai.			Ka ili	7 Roda.

Apana IV. He ana kolo a me ke kula iloko o kahi na ili o "Hekeenu" a me "Chiaiki". Heke o keia Apana ma kule ana o Hele lona o Kaleiwaha. Ua hookele o D. Malo ia Kaleiwaha; aka, ua ae ma ia Hele, a ua anaia mai ke Hele.

E hoomaka ana ma ke kiki Heema o keia aia ma kahi i pili i ke William Naka, a e holo ana

Akau	64	Komohana	4. 78	Kaula ma ke Alamu
Akau	28 3/4	Hikina	1. 25	"
Akau	63 1/4	Komohana	11. 21	"
Akau	2	Hikina	2. 78	" kula mahoeia
Akau	21	Hikina	1. 58	"
Akau	58	Hikina	5. 57	"
Akau	16	Hikina	1. 10	"
Akau	55	Hikina	2. 76	"
Akau	69	Hikina	1. 73	"
Akau	88	Hikina	3. 06	"
Ma kula Aono				

Akan	21 $\frac{3}{4}$	Hikina	7, 43	Kaulahao	ma ke kula matu' oleia
Hema	75	Hikina	11, 51	"	" " ke Hilo, Hinai, na loi foalima
Hema	32	Kemohana	16, 00	"	" " ke Hilo, Hinai, na loi foalima
Hema	23	Kemohana	10, 20	"	" " ke Hilo, Hinai, na loi foalima

a hiki aku ma kahi i hoomaka ai. Ka ili " 31 Eka, 2 Rudo, 20 Rodo.

Olelohoakaka. Ua kono no kekahi Lāi Palima, a ua oleia kekahi e ka Awa e moe ana
 Hema 32' Kemohana 16, 00 Kaul. Aka, ua manao o D. Malo e hui i ka mau loi foalima
 me ka Mo'i K. III. L.P.U.

31.2.20
 2.20
 32 1.07

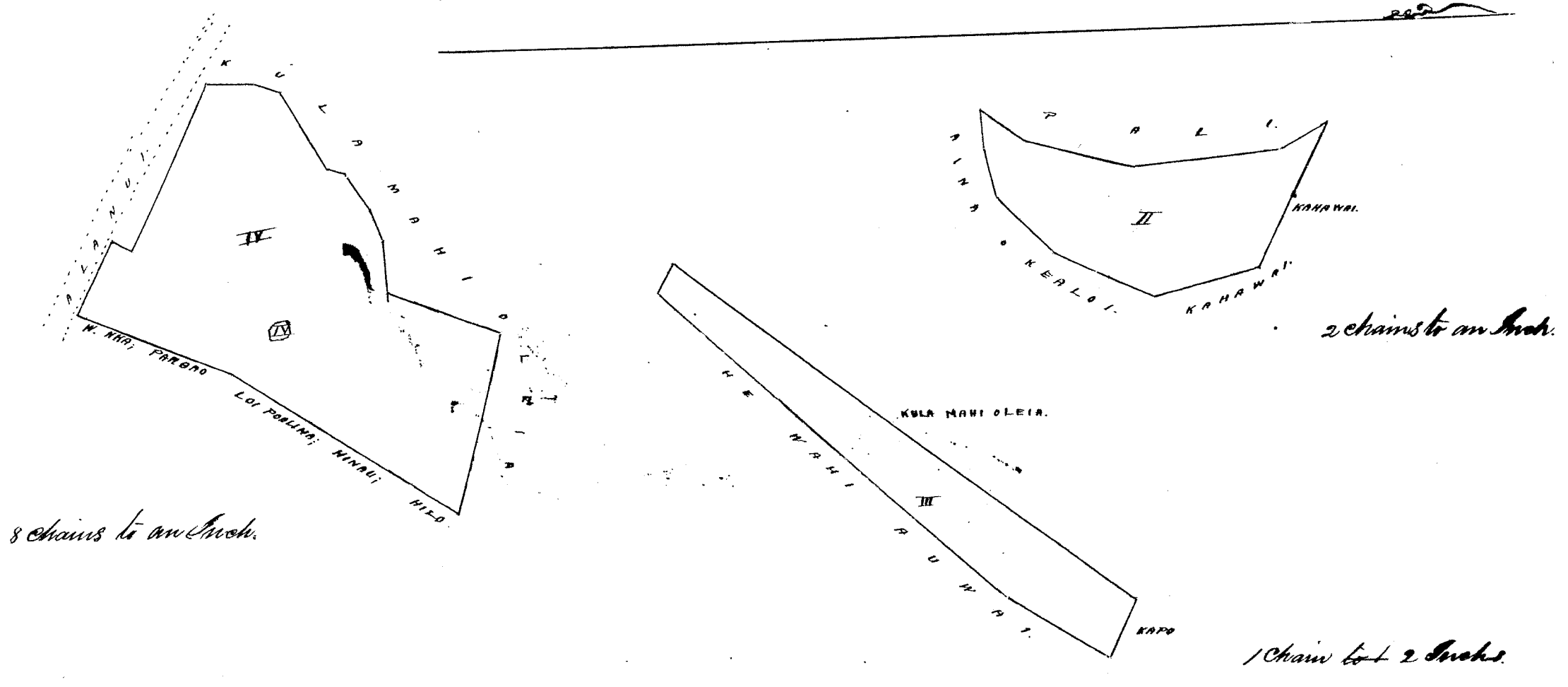

3702 \$
 Helu 659 Davida Malo
 Apana 2

Ua hoi mai oia no kona mau wahi ma Moalii i Lahaina ma ka Mokupuni o Maui; no
 ka mea, ua hooa ia ia keia mau wahi no Adams Kuakini mai ke Kūiaina o Hawaii i ka maha-
 hiki 1838 or 1839, a ua noho keakea oleia a hiki i keia manawa.
 Oia ka makou e hooke nei no Davida Malo, ke kuleana hoi kona malalo o ke Awa
 Aloha. Ina e ukui mai oia i ke ke Aupuni hapaha; alaila, ua kupaia ka Palapala Pila Aloha.
 Iono, mae ia ia ke ukui no ka hookekele a me ka hoohele ana i ka olelo. Penei;

- W. Shee No ka rumi a me ke pua ana i ka olelo ma ka Maiepa.
- G. M. Robertson No ke kope ana i ka olelo Koina
- J. H. Smith No ka palapala kii
- J. Kaulahao No ka hana ana i ka la 19 o June 1849.
- No ke kope ana i na olelo a ma hoi ke 1/2 Awa
- No ke kope ana i ka la 23 o October 1851. — Ua ukui
- No ke kope ana
- No ka hoohele ana i ka olelo Sepatemaba 14; 1852.

Oia na palena. Anai o L.P.U.

\$ 6.00

Ke ana ana i na Apana ana o D. Malo ma ka Aupuni o Moalii ma Lahaina, Maui.
 Apana 1. Eia mo kula ma ka ili o "Hihobua". E hoomaka ana ma ke hiki Hema
 Hikina o keia ana ma kahi i pili ai i ke Awa me ka foalima e holo ana

Akai	11 1/4	Hikina	1.07	Kaulahao	ma ke	Keawa-paalima
Akai	76	Komohana	6.21	"	"	Keawa
Akai	11	Hikina	0.35	"	"	"
Akai	74	Komohana	2.61	"	"	"
Kea	54 1/2	Komohana	0.46	"	"	a hiki i kea pa
Kea	58	Hikina	3.20	"	"	"
Akai	18 1/4	Hikina	0.38	"	"	"
Kea	69 3/4	Hikina	6.14	"	"	"
a hiki i kahi i hoomaka ai. Ka ili				2 Ruda 37 Ruda.		

Akai 2. He wahi kula, ma pumi i kea pa, aia no ma ka ili o "Kiholaa"

E hoomaka ana ma ke kahi Kea Komohana o keia aia ma kahi i pili ai i ke Kea Paka a holo aku

Kea	61 1/2	Hikina	3.17	Kaulahao	ma ke	Kanehewaa & Kea Paka.
Akai	69 1/4	Hikina	1.11	"	"	Pakahi
Akai	32 1/4	Hikina	1.20	"	"	"
Akai	4 3/4	Komohana	1.36	"	"	Timoteo
Akai	21 1/2	Komohana	2.10	"	"	"
Akai	56 1/4	Komohana	1.32	"	"	Kahale
Kea	64 3/4	Komohana	2.27	"	"	"
Kea	86 1/2	Komohana	0.76	"	"	Kea Paka
Kea	6 1/2	Komohana	2.10	"	"	"
a hiki i kahi i hoomaka ai. Ka ili				1 Eka 2 Ruda 14 Ruda.		

Akai 3. He kahi mo kula ma ka ili o "Kiholaa" E hoomaka ana ma ke kahi Kea Komohana o keia aia ma kahi i pili ai i ke Kea a ma ke paalima a holo aku

Akai	82 1/2	Hikina	2.57	Kaulahao	ma ke	Keawa
Kea	79	Hikina	3.04	"	"	"
Akai	20	Hikina	0.40	"	"	"
Akai	79 1/4	Komohana	2.07	"	"	"
Akai	86 3/4	Komohana	3.96	"	"	a hiki i kea paalima
Kea	19	Hikina	0.80	"	"	paalima
a hiki i kahi i hoomaka ai. Ka ili				4 Ruda		

212.37
182.14
2.11.75
4 } next page 1 2 35
E 4 0 50

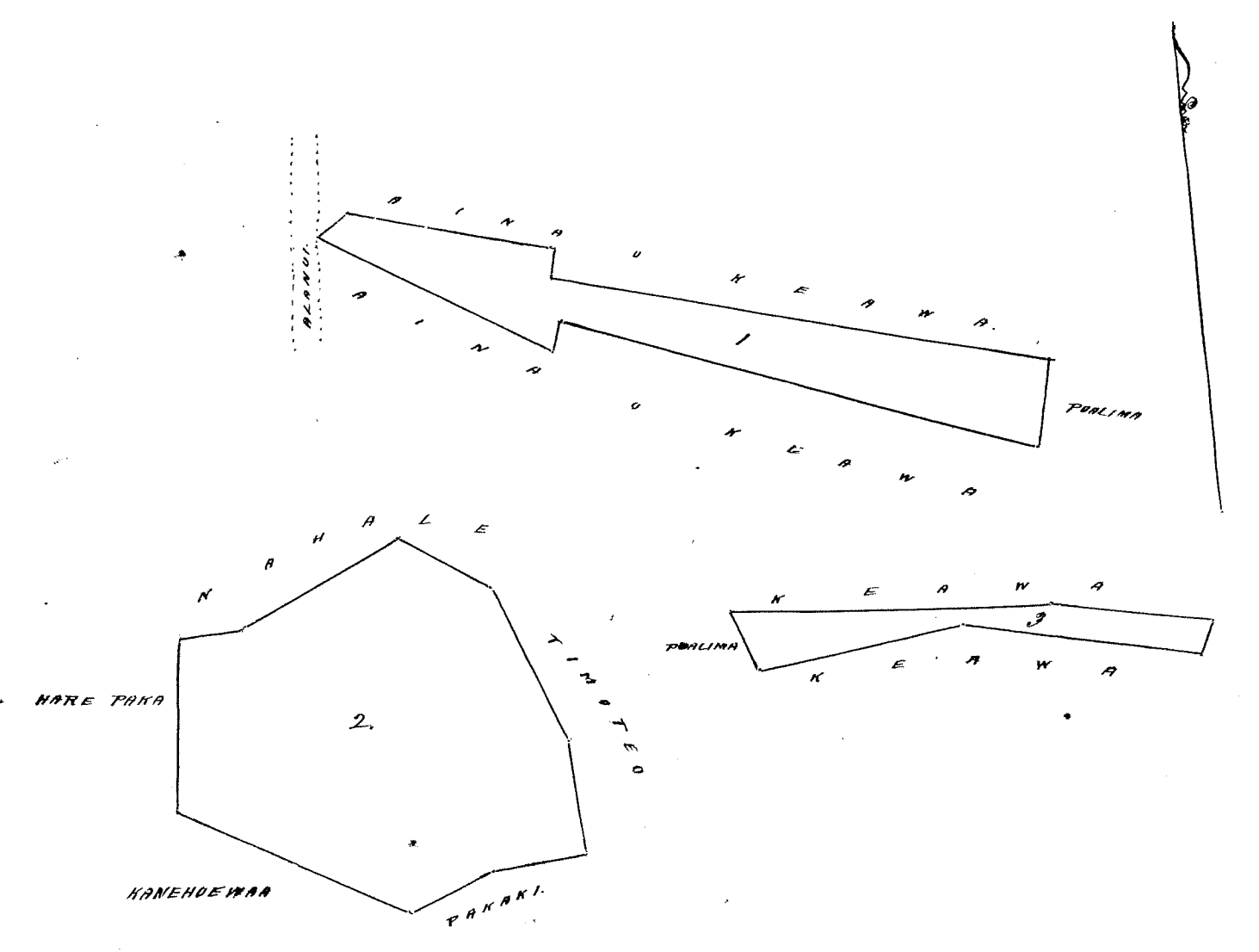

2 Chains = 1 Inch.

Heleu 3702 Davida Mako (Mauka)

Apana 2

Ua hoi mai oia no kona mau wahi ma Hamiti i Lahaina ma ka Mokupuni o Maui; no ka mea ua loa ia ia keia mau wahi no Hoapili Waiene mai i ka makahiki 1835 a ua noho keakea oia a hiki i keia manawa.

Oia ka maku e hooke nei no Davida Mako, ke kula hoi kona malalo o ke Ano Alodio. Ina e uku mau oia i ke ke Aupuni hapaha, alaila, uaku pono ia ia ka Palapala Sila Alodio.

Pino nae ia ia ke uku no ka hookele a me ka hoohele una i ka olelo. Penei.

- | | |
|---|---|
| <p>W. M. Robertson
D. H. Smith
J. Kehaulana</p> | <p>No ka puni a me ke pai ana i ka olelo ma ka Nupepa.
No ke kope ana i ka olelo koina
No ka palapala kei
No ka hana ana i ka la 19 o Iune 1849
No ke kope ana i na olelo a na hoihe
No ka ana ana i ka la o Pepatimaha Ua ukuia
No ke kope ana
No ka hoohele ana i ka olelo Pepatimaha 11, 1852.</p> |
|---|---|

\$ 6.00

Eia na palena. Apana e L. S. Ma.

Ke ana ana i kahi mau Apana ana o Davida Mako ma ke Aupuni o Maui ma Lahaina, Maui. 1. "Kohala" aia keia ana ma ka ahu o ka ana o ke Kulanui o Lahaina ma ka ahu o ke ana o Lahaina. E hoomaka ana ma ke kahi Maui a keia ana ma ka pa hana o ke kahawai, a holo aku Maui 75 1/2 Kamehana 4, 53 Kaulana ma "Kaua"

Kama	14 1/2	Kamehana	1, 79	" "	Kaua
Kama	78	Kamehana	10, 92	" "	Pali
Maui	7	Kamehana	1, 77	" "	Kula
Maui	72 1/2	Kamehana	3, 67	" "	ka pali
Maui	78	Kamehana	2, 58	" "	Kahawai

a hiki i kahi i hoomaka ai. Ka ili 1 Eka, 2 Ruda, 35 Ruda.

2. "Maui" ma ke Aupuni o Maui ma Lahaina Maui. E hoomaka ana ma ke kahi Kama Kamehana a keia ana, kahi i fili ana i ka ana ma ka ahu o ke Aupuni Kula a me ka pa no ka Maui, a e holo ana

Maui	57	Kamehana	2, 79	Kaulana ma ke ke Maui Kamehana III
Kama	38 1/2	Kamehana	0, 89	" "
Maui	56 1/2	Kamehana	6, 17	" "
Maui	30 1/2	Kamehana	1, 50	" "
Maui	65	Kamehana	0, 83	" "
Maui	29 1/2	Kamehana	0, 70	" "
Kama	61	Kamehana	10, 26	" "
Kama	41	Kamehana	1, 81	" "

a hiki i kahi i hoomaka ai. Ka ili 3 Eka.

3. "Maui" ke Aupuni ma Lahaina Maui. E hoomaka ana ma ke kahi Maui a keia ana, ana kahi i fili ana i ke Aupuni Aupuni a holo ai i ka ana pa a me ke Polu a e holo ana

Kama	62	Kamehana	4, 37	Kaulana ma ke Polu
Maui	57	Kamehana	1, 59	" "
Kama	69	Kamehana	13, 07	" "
Kama	15 1/2	Kamehana	3, 27	" "
Maui	48	Kamehana	1, 40	" "
Maui	74	Kamehana	5, 46	" "
Kama	53	Kamehana	3, 69	" "
Kama	62 1/2	Kamehana	2, 09	" "
Kama	83 1/2	Kamehana	5, 81	" "
Kama	69	Kamehana	2, 26	" "

Maui 8 1/2 Kamehana 10, 30
 Kama 81 Kamehana 1, 38
 Maui 5 Kamehana 1, 44
 Maui 5 Kamehana 1, 00

a hiki i kahi i hoomaka ai. Ka ili 1 Eka.

Scale 2 Chains to an Inch.

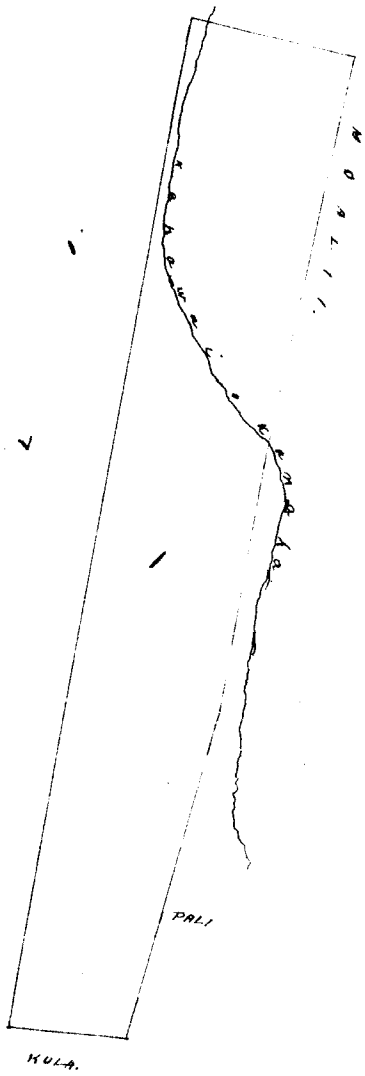
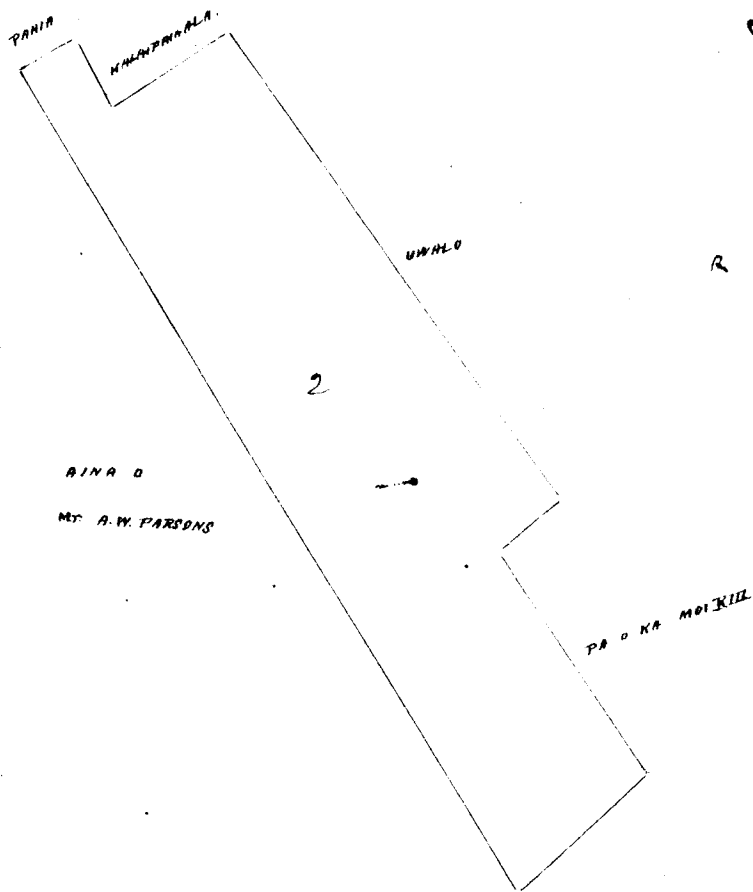

Scale 4 Chains to an Inch.

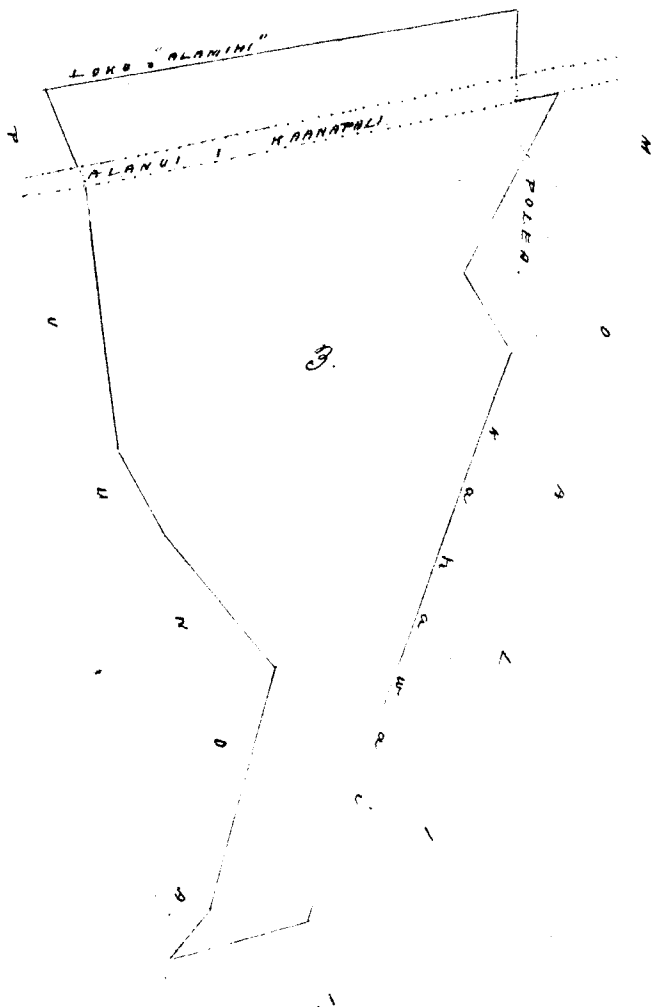

1386
Lot 5834 Kaweewa

Ua kōi mai oia no kona manawa wahi ma Puako i Tahaina ma ka Nōkūpuni o Maui; no ka mea, ua loaa iā ia keia manawa no Kōona mai i ka manawa o Kōopili, a ua noho keakea oia a hiki i keia manawa.

Oia ka maku e hōko nei no Kaweewa; he kōkōna hei kona malalo o ke Ano Alodio. Ina oia mai oia i ke ke Kupuni hapaha; alaila, ua kōpuno iā ia ke Palapala Pila Alodio.

Poni nae iā ia ke utu o ka hōkolehōle a ma ka hōhōle ana i ka olelo. Poni. # H. n.

- | | | |
|--|--|-----------------------|
| <p>W. M. P.
 G. M. Robertson
 W. M. Smith
 J. K. Kamaulaha
 C. M. Palena</p> | <p>No ka nuni a me ke Spaiana i ka olelo ma ka Mijupa
 No ke kōpuna i ka olelo kōma
 No ka palapala he
 No ka hana ma i ka la 29 May 1849.
 No ke kōpuna i na olelo a ma hōhōle 1/2 An.
 No ke ana ana i ka la (The Survey Price for)
 No ke kōpuna
 No ke hōhōle ana i ka olelo Spalena 11, 1852.
 Anna o W. P. Alexander</p> | <p>Pauloa \$ 4 00</p> |
|--|--|-----------------------|

Notes of a survey of the Antenna Claim of Kaweewa deceased N. 5834 Kaweewa Claimant deceased, Kamakana his widow. This is a house lot and a kalo patch in distinct pieces in Puako in the town of Tahaina on the Island of Maui.

- 1st The house Lot as follows. Beginning at the South corner & running,
- | | | | |
|-----------------------------------|----------|------------------------------------|----------|
| N. 48 ³ / ₄ | E. 2. 13 | Chains along the land of Kōkōmōchi | |
| N. 43 ¹ / ₂ | W. 1. 53 | " | " |
| S. 50 ³ / ₄ | W. 1. 90 | " | Kōkōlehi |
| S. 33 | E. 1. 59 | " | " |
- to the beginning. Containing One Rod & Eleven Poles.
- 2nd The kalo patch as follows. Beginning at its East corner & running,
- | | | | |
|-----------------------------------|----------|----------------------------|--------------|
| S. 57 ¹ / ₂ | W. 1. 36 | Chains along lot of Niānia | |
| N. 30 | W. 1. 12 | " | Makūlia |
| N. 59 ¹ / ₂ | E. 1. 19 | " | Kōpuna |
| S. 37 ³ / ₄ | E. 1. 09 | " | Kōkōhapalani |
- to the beginning. Containing Twenty three Poles.

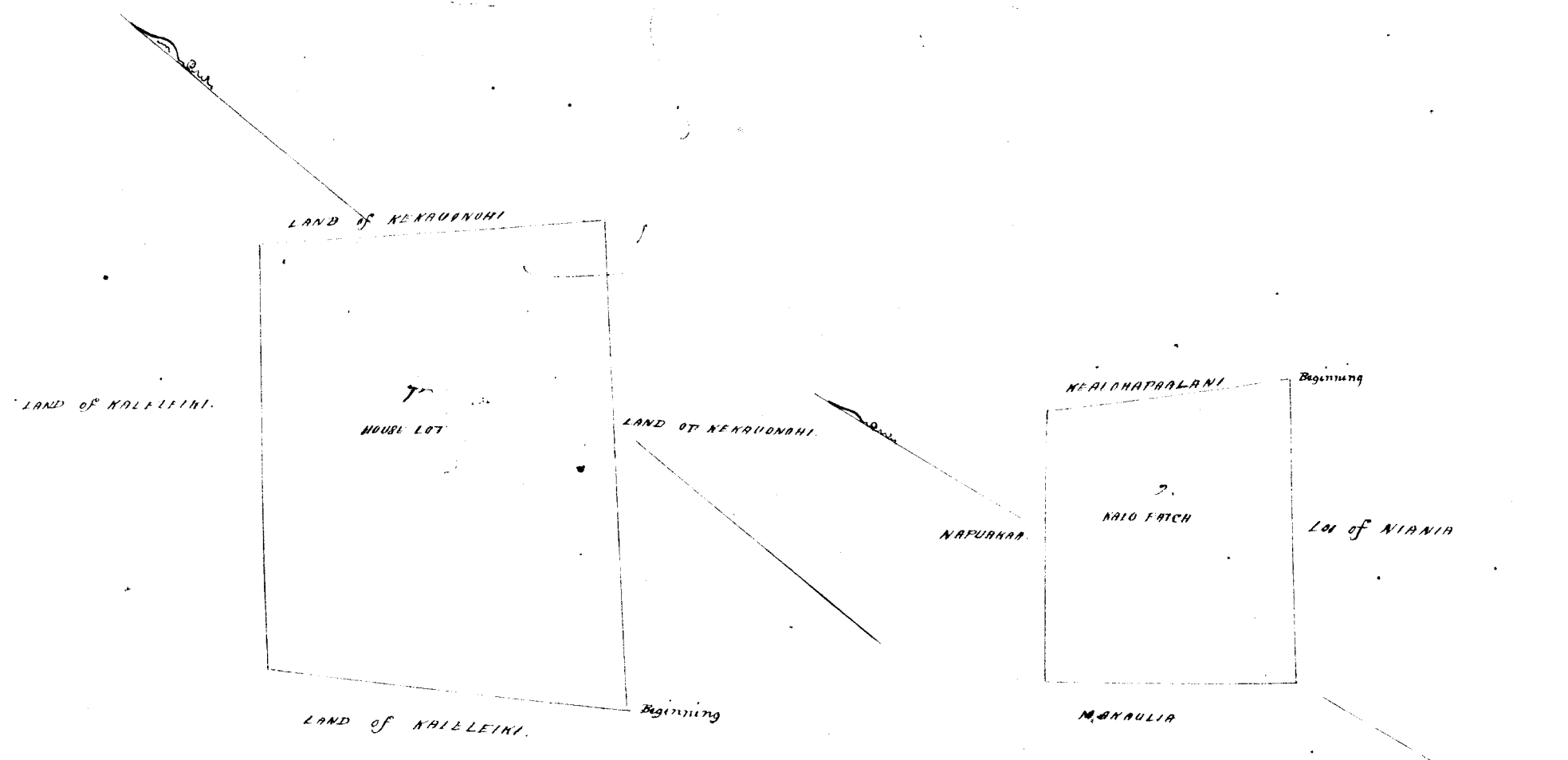

Scale 1 Chain = 1 1/2 Inches.

Scale 1 Chain = 1 1/2 Inches.

Hulu 6211 Maimai

(From Page 1458 V.2.)

Ua kōi mau'ia no kōi wahi ma Pūhūhūmū i Lūhāina ma ka Mōkūpuni o Māui; meka ma, na lāo iā iā kōi wahi no Kaulānāi mai i ka māhāhāi 1841, a ua nō ho kōi oia i hiki i kōi mānawa.

Oia ka mākau o hōke mōi no Māimāi, he kuleana hōi kōi ma'atolu o ke Aho Abolū. Iua e nō mau'ia i ke ke Aupuni hōpūhā; atāia, ua hōpūhā iā iā ka Palapala Pūhā Abolū. Iua, nō iā iā ke nō ka hōke hōke a meka hō hōle ana i ka olelo. Iua;—

M. Lee	No ka kōi ma'ia meka hōi ana i ka olelo ma ka Aupuni	\$ 1
G. M. Robertson	No ke kōi ma'ia i ka olelo kōi ma	50
J. H. Smith	No ka palapala hōi	50
	No ka hōi ana i ka lā 6 o Iune 1847	1
J. Kekaulāhō	No ke kōi ma'ia i ka olelo a na hōi ke 1/4 Aho	50
	No ke ana ana i ka lā	2
	No ke kōi ma'ia	50
	No ke hō hōle ana i ka olelo Epātemāka 14, 1852.	2.50
		<u>\$ 8.50</u>
Oia na palapala	Iua o W. P. Alexander	

Apana 2. He palapala hōi i ke ana ana i kōi kōi Apana Aina kuleana o Māimāi Hulu 6211. He palapala e waiho ana ma Pūhūhūmū ma Lūhāina Māimāi. E hōi ma'ia ana ma ke hōi kōi kōi Apana Aina kōi i pūhā ai iā i na ana o Kālehuāna lāua o Kālehuāna, a hōle ana

Akua 64 1/4	Hōi ma'ia	3. 13	Kaulāhō ma ka Mōkūpuni
Kōi ma 37	Hōi ma'ia	0. 30	" " "
Akua 38 1/2	Hōi ma'ia	2. 85	" " " Pi
Akua 56 1/2	Hōi ma'ia	2. 14	" " " a hōi iā Lūhā
Kōi ma'ia		3. 32	" " " Lūhā
Kōi ma 69 1/4	Kōi ma'ia	3. 67	" " " ke ana o Iua.
Kōi ma 41	Kōi ma'ia	0. 85	" " " ke Iua a hōi iā Kālehuāna.
Kōi ma 17	Hōi ma'ia	2. 19	" " " i pūhā ai iā Kālehuāna
a i kōi i hōi ma'ia ai.	Kālehuāna		He kōi kōi Eka, he Kōi kōi Kōi ma'ia ma'ia o Iua.

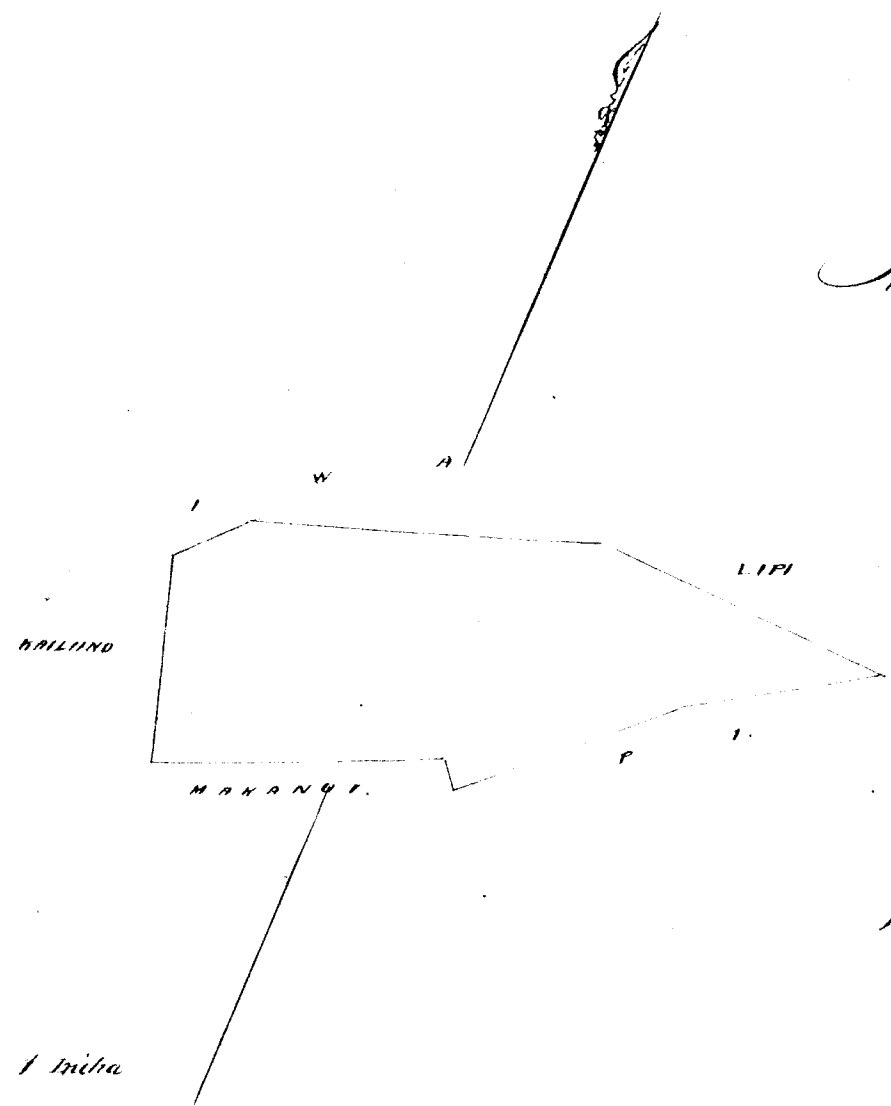

Ma'ia Aho 1458 V.2.

Page 6 of 15 List 7
these said to belong to the Hei of Kōi ma'ia

Scale 1 Kaulāhō = 1 Ma'ia

Olelo hōi kōi. O kōi Apana 2 o Māimāi i hōi kōi ma'ia, meka, meka, meka, meka o Māimāi ma kōi Apana, a ua hōi i ke Aho Māimāi ma'ia 11, a hōi ana ma'ia.

Epātemāka 20, 1852. J. P. Nailili Kōi ma'ia o na Lūhā.

Na kei mai oia no kona mau wahi ma Uaianae a me Puako i Tahaina ma ka
Mokupuni o Māui; no ka mea, na lāka i oia keia mau wahi no

Ua hoi mai oia no kona wahi ma Waiananai i Lahaina ma ka Mokupuni o Maui; ma ka mea ua loaa ia ia keia mau wahi no Waialeale inai i ka makahiki 1841, a ua loaa hoi ia Waialeale no Kulu mai i ka makahiki 1838, a ua noho keia oia i hiki i keia mau wahi.

Oia ka wahi e hooke nei no Mauae; he kulemahi kona malalo o ke Awa Olole, Iua i keia mau oia i keia mau wahi; alaila, ma kupaia ia ia ka Palapala Ika Olole.

Iua ma ia ia keia mau oia i keia mau wahi a me ka hooke ana i keia olole. Iua;

W. H. Bee	No ka omi ana ke fua ana i ke olole ma ka Muepa.		
J. H. Smith	No ke kupa ana i ke olole keia.		50
	No ka palapala keia.		30
	No ka hana ana i ka ka 15 o Iune 1849.		1
J. Kekaulaha	No ke kupa ana i ke olole ma ka hiki 1/3 Awa.		
G. W. Robertson	No ke ma ana i ka ka.	Ukaia ke ana ana #2. - W.A.	
Louise	No ke kupa ana.		50
	No ka hooke ana i ke olole, Iuputimaha 14, 1852.		2 50
Oia na palewa.	Anaia o U.P. Alexander & L.P. Ma.		6-25

Apana 1.

Ma kona hufeana ma ke Mokupuni o Waiananai ma Lahaina, Maui.

E hoomaka ana ma ke hiki oia i keia mau wahi, a e holo ana

Kona 63°	Komohana 2, 87	Kaulaha e fua ana ma ka Kaulaakuni
Kona 31°	Hikiina 2, 64	" " I. M. M. M.
Kona 11°	Hikiina 3, 01	" " Iuaiki
Akau 48°	Hikiina 0, 39	" " Waialeale
Akau 30 1/2	Komohana 4, 61	" " "

a hiki hoi i keia mau wahi i hoomaka ai.

Ma Ili Hookele Eka & Iua i keia mau wahi ma ka hiki i keia mau wahi.

Apana 2. He ana ana i keia mau wahi ma Mauae, a ma ka hiki ma ke Mokupuni o Waiananai ma Lahaina Mokupuni o Maui.

He Apana ana ka. E hoomaka ana ma ke hiki oia i keia mau wahi, a e holo ana ka ana ana ma ke hiki i keia mau wahi.

Akau 4°	Hikiina 1, 03	Kaulaha ma ke Mokupuni
Akau 45 1/2	Hikiina 0, 35	" " a hiki i keia mau wahi
Akau 67°	Komohana 2, 39	" " Awa-i
Kona 4°	Hikiina 1, 44	" " Waialeale
Akau 76 1/2	Hikiina 0, 39	" " "
Kona 6°	Hikiina 0, 62	" " "
Kona 77°	Hikiina 1, 35	" " Kaulaha

a hiki i keia mau wahi i hoomaka ai.

Ma Ili Ika 13 Roda.

Anaia o L.P. Ma. ka Apana 2.
Ikaemaha 6, 1851.

Ua hoo ke ana ana
L.P. Ma

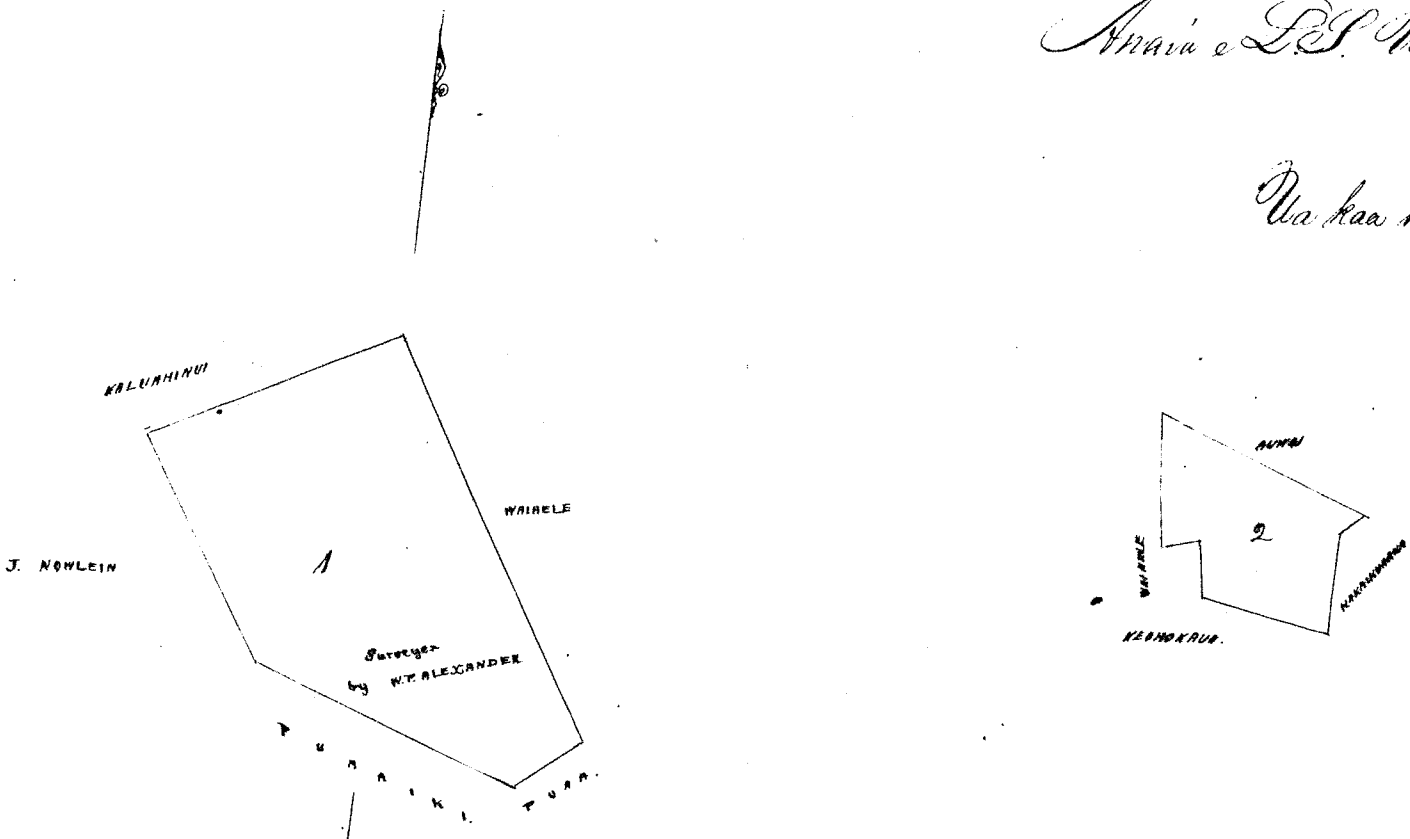

Scale 2 Chains to an Inch

Hele 671 Puuki

Ua koi mai oia no kona mau wahi ma "Uhae" ke Kapalua o ke Ahupuaa o Uhae ma Pahama ma ka Mokupuni o Maui; no ka mea, ua loa ia ia keia mau wahi no ke Miihana Hamocho III mai i ka Mahalo aia ana i ka M.H. 1848, a ua noho keia oia a hiki i keia manawa.

Oia ka maku e hoko nei i Puuki, ke Kuleana hoi kua malalo o ke Ara Alodiv. Ina e uku mai oia i ke ke Uupuni hapa ha; alaia, ua kuperu ia ia ka Palapala Lila Alodiv. Koe aia no kuleana o na Kanaka maika.

pono, no ia ia ke uku no ka hoko kolo a me ka hoholo ana i ka olelo. Puni # Ken.

M. Lee	No ka auni a me ke faai ana i ka olelo ma ka Mupua.	1
	No ke kope ana i ka olelo koina	50
	No ka palapala hoi	50
J. H. Smith	No ka hana ana i ka la 1 o Iune 1849	1
J. Kekaulaha	No ke kope ana i ma olelo a ma hoi ke 1/2 Ara.	50
G. M. Robertson	No ke ana ana i ka la 25 o Feb. 1852.	4
Loane Li	No ka hoholo ana i ka olelo, Sepatemaba 14, 1852.	50
		<u>27 50</u>
		<u>\$ 10.50</u>

Ua hoko aku ma ka i keia kuleana mamuli o ma olelo o ke Kanawai hoi i hoholoia i ka la 19 o Iune M.H. 1852, e fili ana i ma "Konehiki".

Eia na palena. Aniani L.P. Wa & W.P. Alexander

No ana ana i ke kuli Apana aia o Puuki ma ke Ahupuaa o "Uhae" ma Pahama, Mokupuni o Maui.

Apana 1. Ke Puuki aia kolo keia, aia i toki lilo o ke awawa o Kanawai. E hoomaka ana ma ke kuli Akau o keia ma kahi i fili aia i L.P. Wa a me Kanawai, a holo aku

Kama	27 1/2	Hikina	1.03	Kaulaha ma ke L.P. Wa
Kama	85	Komohana	0.40	" " " " " " " "
Kama	65	Komohana	1.85	" " " " " " " "
Kama	56 1/2	Komohana	1.56	" " " " " " " "
Akau	26	Komohana	0.36	" " " " " " " "
Akau	6	Hikina	2.18	" " " " " " " "
Akau	17 1/2	Hikina	0.80	" " " " " " " "

a hiki i kahi i hoomaka ai. Ka Ali 12 Roda.

Ma L.P. Wa i ma.

Apana 2. Ke kuleana keia o Puuki ma ke Ahupuaa o "Uhae" ma Pahama i Maui. E hoomaka ana ma ke kuli Akau Komohana, a e holo ana.

Kama	59 1/2	Hikina	1.53	Kaulaha e fili ana me ke Wa
Akau	27 1/2	Hikina	9.15	" " " " " " " "
Akau	46 1/2	Hikina	1.86	" " " " " " " "
Akau	38 1/2	Komohana	0.47	" " " " " " " "
Kama	43	Komohana	2.87	" " " " " " " "
Kama	37 1/2	Komohana	3.97	" " " " " " " "
Kama	31 1/2	Komohana	4.37	" " " " " " " "

a hiki i kahi i hoomaka ai. Ka Ali 1 Eka & 11 Roda.

Ma W.P. Alexander i ma.

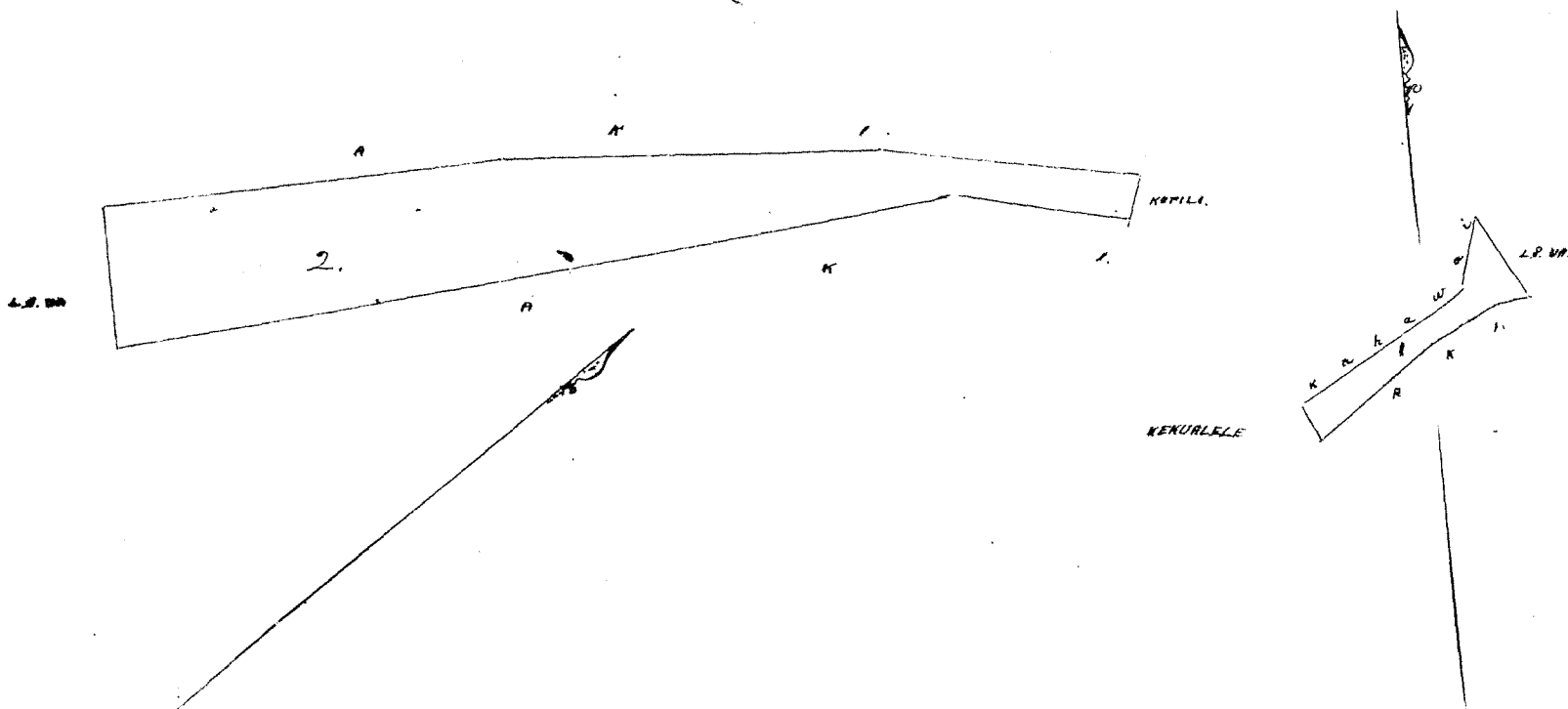

Plate 2 chains to an Incha

Helu 6853 Nuhii 1846

Ua kōi mai oia no kona wahi ma Pūhukunui ma Lahaina ma ka Mokupuni o Mani; no ka mea ua loa iā ia keia wahi no Kāhahuna maia i ka makahiki 1841, a ua mōhō keakea oia a hiki i keia manawa. Oia ka mākau e hōke oia no Nuhii, he kūlana hōi kona malalo o ke Ano Aloha. Ina e ruku mai oia i ke ke aupuni hapaha; alaila, ua kōpuna iā ia ka Palapala Pila Aloha.

Toni mai iā ia ke ruku no ka hōhōlo kōlo a me ka hōhōlo ana i ka olelo. Pēnei, —

- W. Lee No ka suni a me ke fōi ana i ka olelo ma ka Mōpepa.
- No ke kōpe ana i ka olelo kōma.
- No ka palapala kōi
- No ka kōma ana i ka la 2 o Iune 1849.
- J. H. Smith No ke kōpe ana i ma olelo a ma hōike 1/2 Aloha.
- J. Hoopaunahao No ke ma ana i ka la Ukaia ke ma ana #2.
- G. W. Robertson No ke kōpe ana.
- Loane Li No ka hōhōlo ana i ka olelo. Sepatēmba 14, 1852.
- Oia ma pūlana: Ania e W. S. Alexander

Ua kōna ana ma ke Aloha o Pūhukunui ma Lahaina, Mani. E hōmaka ana ma ke kōlo Kōma Kōmohana, a e hōlo ana —

Akau	8° Kōmohana	0, 28	Kaulakas, e fili ana ma ke Kōma
Akau	72° Kōma	0, 61	" " " Co
Akau	86° Kōma	1, 71	" " " "
Kōma	49 1/2 Kōma	2, 26	" " " "
Kōma	58° Kōmohana	0, 21	" " " "
Akau	79° Kōmohana	1, 42	" " " Kōma
Akau	50 1/2 Kōmohana	1, 09	" " " "
Akau	88 3/4 Kōmohana	1, 52	" " " "
i kōlo i ke ma ka ui.	ka Mi		Kōma Kōmohana ma ka Kōma

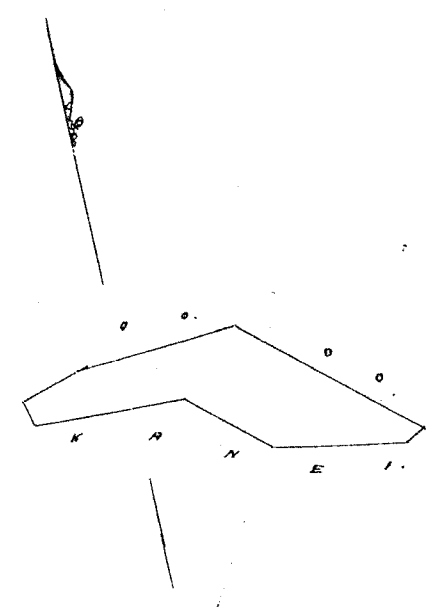

See 1368 12

1846

Helu 506 Kalena

Ua hōia i ka
ka hōia i ka
ka hōia i ka
ka hōia i ka

Ua hōia mai oia no kona wahi ma Kaopulopulo i ke Ahupuaa o Kelauea ma Lakaia
i Maui. ma ka Moku o Maui; no ka mea, ua loa ia ia keia wahi ma Kelauea ma Lakaia
ma Maui. He mau Poi Kala a me Kula. E hōmaka ana ma kahi Kelauea o keia aina ma
Kaopulopulo i ka wahi o Kalakini a me ka auwai a e makahiki 1843, a ua loa hoi ia Kelauea ma
Kaopulopulo ma i ka makahiki 1852, a ua aho keia oia a hiki i keia manawa.
Oia ka wahi e puka mai ma Kalena; he kulepa hoi kona aiala o ke Alo Alodio.
Ma e uku mai oia i ke ke auwai hapaha; alaila, ua hōmaka ia ia ka Palapala Alo Alodio.
Pono navi ia i ke uku no ka hōhohole a me ka hōhohole ma i ka olelo. Penei;

Wahi	No ka rumi a me ke pi'i ana i ka olelo ma ka Moku	\$	Ken.
	No ke kope ana i ka olelo Koina	1	-
	No ka palapala kii		50
J. H. Smith	No ka hōmaka ana i ka la 29 o Mei 1849.		50
S. Kelauea	No ke kope ana i ka olelo u na hōhohole 1/2 auwa	1	-
G. M. Robertson	No ke ana ana i ka la 29 o Iulai 1851.		50
Louisi	No ke kope ana	2	-
	No ka hōhohole ana i ka olelo Sepatemaba 14, 1852.		50
			2 50
		\$	8.50
Eia ma palena	Maui a L.S. Ua.		

Ke ana ana i ke kahi o Apiana oia ma Kalena ma ka ali o Kaopulopulo ma ke Ahupuaa o
Kelauea ma Lakaia i Maui.
Apiana, 1. He mau Poi Kala a me ke Kula. E hōmaka ana ma kahi Kelauea o keia
aina ma kahi i kahi ai ia Kalakini a me ka auwai, a e hōlo ana Kelauea 50 Kom. 2, 09 Haul.
ma Kalakini; alaila Kelauea 38 Kom. 2, 39 Haul. ma Kalakini a Pihanele; alaila Kelauea 33
Kom. 1, 09 Haul. ma Pihanele a ohi ana i ke kahawai a hiki i ke Kapa Komohana o ke kahawai;
alaila Kelauea 42 1/2 Hiki 5, 34 Haul. ma Kapa Komohana o ke kahawai; alaila, Kelauea 42 1/2 Hiki
2, 46 Haul. a ohi ana i ke kahawai a hōlo aku ma ka aina o Haninan a pui i ka pali; alaila,
Kelauea 61 Hiki 3, 25 Haul. ma ke Kula a hiki ia Kelauea; alaila Kelauea 41 Kom. 3, 32
Haul. ma Kelauea; alaila Kelauea 52 Kom. 5, 82 Haul. ma Kalakini a hiki i kahi i
hōmaka ai.

Ma ia Apiana 1 Eka, 3 Roda, 24 Roda.

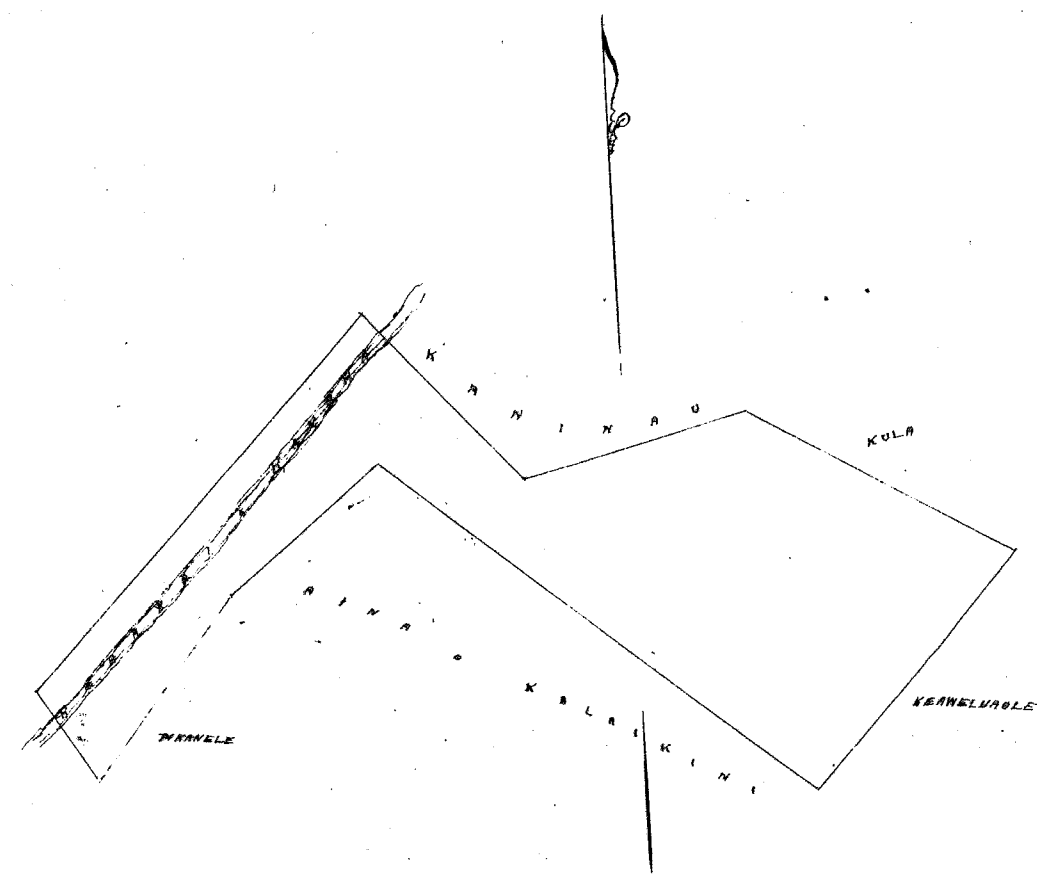

Ana 2 Kelauea i ka Kula.

Hulu 10605 Iona Pihoi

Apana 1

Ua koi mai oia no kona mau wahi ma Pualoalo, he Aliama ma ke Ahupuaa o Himoehoa, ma ka Mokupuni o Oahu; no ka mea, ua loa ia ia keia mau wahi no ke Alii Kamehameha III mai i ka Mahalo aia ana i ka M.H. 1848, a ua waho keakea oleia i hiki i keia manawa.

Oia ka maku e pooko meino Iona Pihoi; he kuleana hoi kona malalo o ke Awalelii. Iho e uhu mai oia i ke ke Ahupuaa hapaha; alaila, ua kupaona ka ia ka Palapala Pala Meoio. Iho na na kuleana o wa Kanaka maloko. Ua huki aku waiho i keia kuleana mamuli o na olelo o ke Kinawaikou i ke hohola i ka la 19 o Iune M.H. 1852. e fili ana i na "Kauhiki"

Iho na inia ke uhu no ka hohola olelo a me ka hohola ana i ka olelo. Ihoi, —

- No ka runi a me ke pua ana i ka olelo ma ka Mupua
- No ke kope ana i ka olelo koma
- No ka palapala hii
- J. Hekaulahau No ka hana ana i ka la 29 o Mei
- M. Lee No ke kope ana i na olelo a wa hoiku
- G. M. Robertson No ke ana ana i ka la 15 o Aperila 1851.
- Ioweli No ke kope ana
- J. J. H. Smith No ka hohola ana i ka olelo Ipatemaba 21, 1852.
- Oia na palena. Anaia e W. Webster & S. P. Kalama

5.00

Description of the boundaries of two parts of the land of Pualoalo in Nuuanu Valley, Oahu the property of Iona Pihoi.

N^o 1. Commencing at the mauka East corner on the east side of the Nuuanu Valley stream opposite the end of Mr Bates fence the boundary runs down along east side of stream to weir of lead to kalo land 469 feet bounded by Kaalaa; thence along the land of Puenuke N. 25° 0' W. 15 feet, thence N. 40° 10' E. 20 feet; thence N. 25° 10' W. 133 feet; thence N. 20° 0' E. 37 feet. thence N. 27° 0' W. 110 feet, thence N. 12° 30' W. 32 feet, thence N. 48° 0' W. 74 feet, thence S. 18° 0' W. 70 feet, thence along the land of Onini N. 45° 40' W. 120 feet, thence N. 25° 0' E. 120 feet, thence N. 37° 10' E. 198 feet, thence N. 5° 40' E. 32 feet, thence along the land of Onini & Mupaiapai N. 31° 30' E. 138 feet, thence along Mupaiapai N. 15° 10' E. 39 feet; thence N. 26° 10' E. 60 feet, thence N. 56° 30' E. 54 feet, thence along the land of Kula S. 64° 30' E. 123 feet, thence along stream bounded by Pualoalo, S. 38° 30' W. 130 feet, thence S. 15° 45' W. 81 feet, thence S. 30° 30' W. 67 feet to Cocoa Nut tree, thence S. 44° 15' E. 31 feet, thence S. 59° 0' E. 75 feet, thence S. 51° 0' E. 54 feet, thence S. 44° 45' E. 90 feet to corner of Mr Bates fence, thence along said fence S. 49° 50' E. 170 feet, thence S. 19° 10' E. 181 feet to commencement. Area 6 ⁴⁹/₁₀₀ Acres.

N^o 2. Commencing at the mauka North corner on a stone wall, the division between this property & James Robertson's the land of Kawananakoa the boundary runs along the land of Kawananakoa S. 62° 0' E. 154 feet to stone wall, thence S. 43° 15' E. 194 feet to point A on Plan, thence round a house lot of Apaki's N. 27° 0' W. 66 feet, thence S. 41° 30' W. 33 feet, thence S. 61° 0' E. 69 feet, thence S. 29° 0' E. 37 feet back to point A, thence along Kawananakoa S. 43° 15' E. 34 feet, thence S. 51° 15' E. 76 feet to large Rock, thence along the land of Charles S. 37° 0' W. 187 feet to Kala trees, thence along in line of Kala trees to a point S. 1° 30' W. 114 feet, thence S. 4° 50' W. 83 feet to Kala trees, thence S. 24° 0' W. 113 feet, thence along the land of Maemaa N. 60° 0' W. 55 feet to end of wall, thence along wall N. 52° 30' W. 116 feet, thence N. 56° 30' W. 32 feet, thence along the property of Pahi N. 31° 30' E. 96 feet, thence N. 56° 30' W. 208 feet, thence along the property of James Robertson N. 5° 0' E. 90 feet, thence along the property of Pahi S. 63° 30' E. 77 feet, thence S. 22° 45' W. 39 feet, thence S. 56° 15' E. 91 feet, thence N. 38° 0' E. 202 feet, thence N. 61° 0' W. 64 feet, thence S. 36° 15' W. 21 feet, thence N. 59° 0' W. 166 feet, thence along the property of James Robertson N. 25° 45' E. 163 feet to commencement. Area 3 ³⁷/₁₀₀ Acres.

Apana 3. Iho o Pualoalo ikai. E hoomaka ma ke kulu Kema o keia aia o fili ana me Hewalo a me Kaakaukuku, a e holo i ka Ahua 13' Hiki: 3' Haul. a i ka Ahua 7 1/2' Hiki: 8' Haul. a i ka Kema 78 1/2' Kom. 1 2/3' Haul. ma Hewalo a me Puumi a hiki i ka pihaku. Alaila iho hohola i ka ma me Puumi o ke Ahupuaa a hiki i ka Puumi o I. Roke ma. Alaila Kema 43' Hiki: 3' Haul. ma Puumi o I. Roke a me Kaakaukuku a hiki i ka hiki i hoomaka 'e. 2 1/2' Eka

Okalaba 24, 1851.

6.49
3.37
2.16
8.02

S. P. Kalama
Iona

Scale 200 feet = 1 Inch.

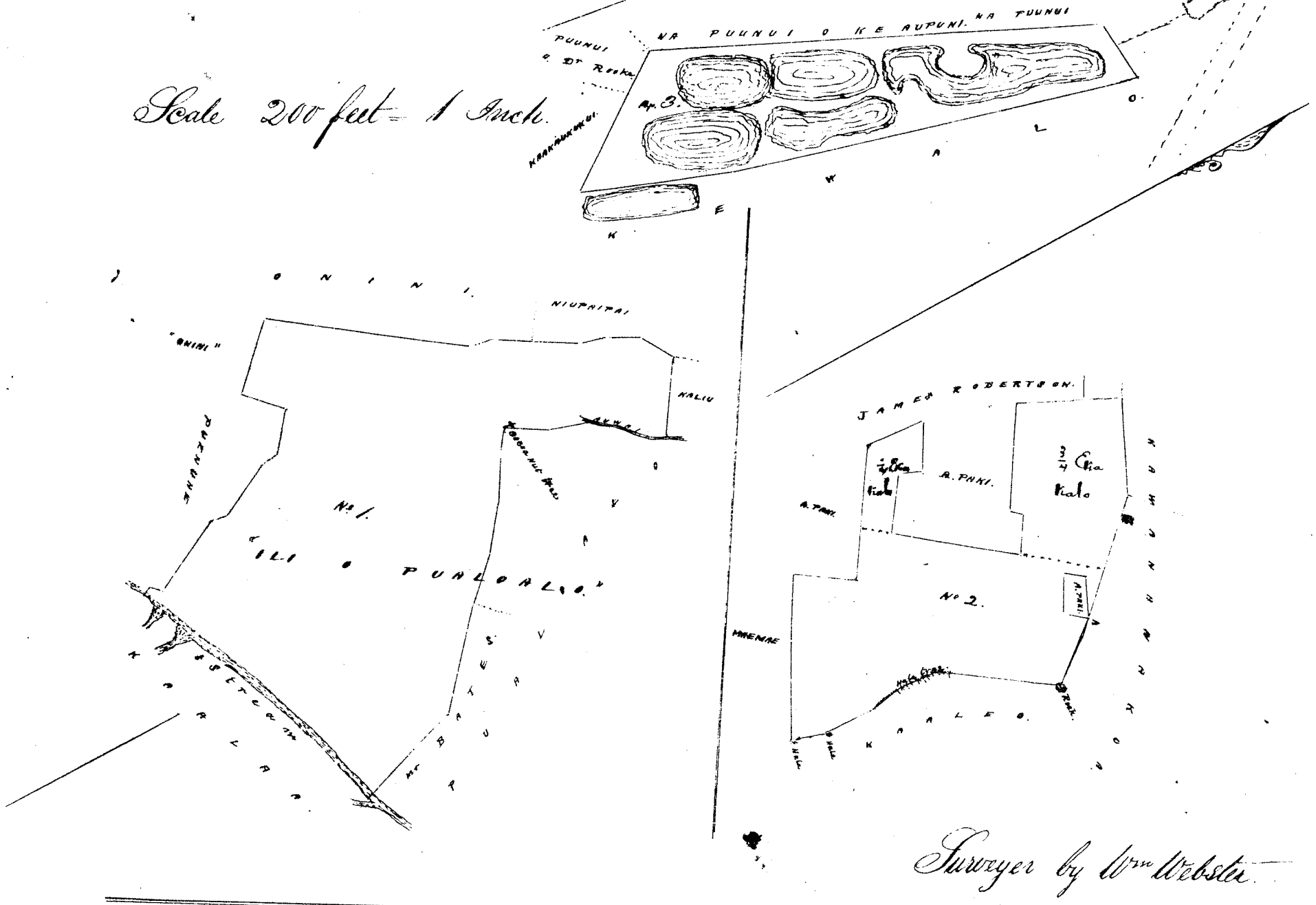

Kelu 10605 Iona Pitiroi

Apana 2

Ua hoi mai oia no kona wahi ma ka Paa, he Ahupuaa ma Kona, ma ka Mokupuni o Hawaii; no ka mea, ua loaa ia ia keia wahi no ke Alii Kamehameha III mai i ka Meehele ana ana i ka M.H. 1548, a ua noho kea ka oia a hiki i keia manawa.

Oia ka anaku e hooke au i ka Iona Pitiroi; he kuleana hoi kona malalo o ke Auniolelo. Ima e uku ana oia i ka ke Aupuni hapaha; alaila, ua kupauna ia ia ka Palapala Auniolelo. Hooe nae mu kuleana o mu karekare malalo. Ua hooke aku anaku i keia kuleana mamuli o wa olelo o ke Kamehameha hoi i hoohele i ka la 19, Iune, M.H. 1852, e pili ana i na Kamehameha. Ima e uku ia i ke uku ma ka hoohele kule o mu ka hoohele ana i ka olelo. Ima.

- No ka nuni a me ke pua ana i ka olelo ma ka Meehele. # Kona
 - No ke kupa ana i ka olelo hoi.
 - He ka palapala hoi
 - No ka hoohele ana i ka la
 - No ka kupa ana i ka olelo a me keia
 - He ka ana ana i ka la 6, October 1851.
 - He ke kupa ana
 - No ka hoohele ana i ka olelo Sepatema 23, 1852.
- I. Kekaulahas
Loane Li
Cia na palapala.
Apana 2 W.D. Pease.

Notes of Survey of the Land called "Paa" situated in the district of Kona, Island of Hawaii made for and on behalf of I. Pitiroi.

Commencing upon the Sea near a monument of stones, which stands upon the easterly boundary of land called "Uluweli" & near the South westerly corner of this land; running from thence North 24° West 70 Chains to a heap of stones on the hill called "Puhunihuni" bounded the Govt. land called "Uluweli"; thence North 23° West 223 Chains to the hill called "Uluweli" crossing the marsh called "Palena"; a short distance west of a monument of stones standing near the Road leading from Kona to Mahalepa; thence North 71° East 27 1/2 Chains to a pihala tree, standing in a Valley near the North & West corner of the marsh called "Palena"; thence South 57° East 35 1/2 Chains to a Kala tree standing at the North & Easterly corner of said marsh called "Palena" passing along the Northerly end of said marsh; thence South

12' West 44 Chains to a stone wall, passing along the easterly side of said marsh, thence South
 43' East 40 Chains to the top of the Hill called "Kulakamoa" & from thence South 80° East 54' 06" Chains
 to the top of the Hill called "Puleia", running along a stone wall, which forms a part of the westerly
 boundary of the pasture land belonging to the Koloa plantation & held by R. W. Wood under lease
 No. 20. from thence South 28° East 36 Chains to a heap of stones, standing a short distance west of
 the Koloa & Mahanaloa Road, bounded by the land Mahanaloa, thence South 49° East 98 Chains
 to the westerly point of Pond & Pali called "Kapuakea", bounded by said Land of Mahanaloa, thence
 North 55° East 15 Chains along said Pond & Pali; thence South 65° East 10 Chains to a Rock upon the
 sea at the South westerly corner of the village of Mahanaloa, from thence following the sea to point
 of commencement, comprising an Area of Two Thousand one hundred & ninety six Acres
 Three Rods (2196 Acres 3 Rods.)

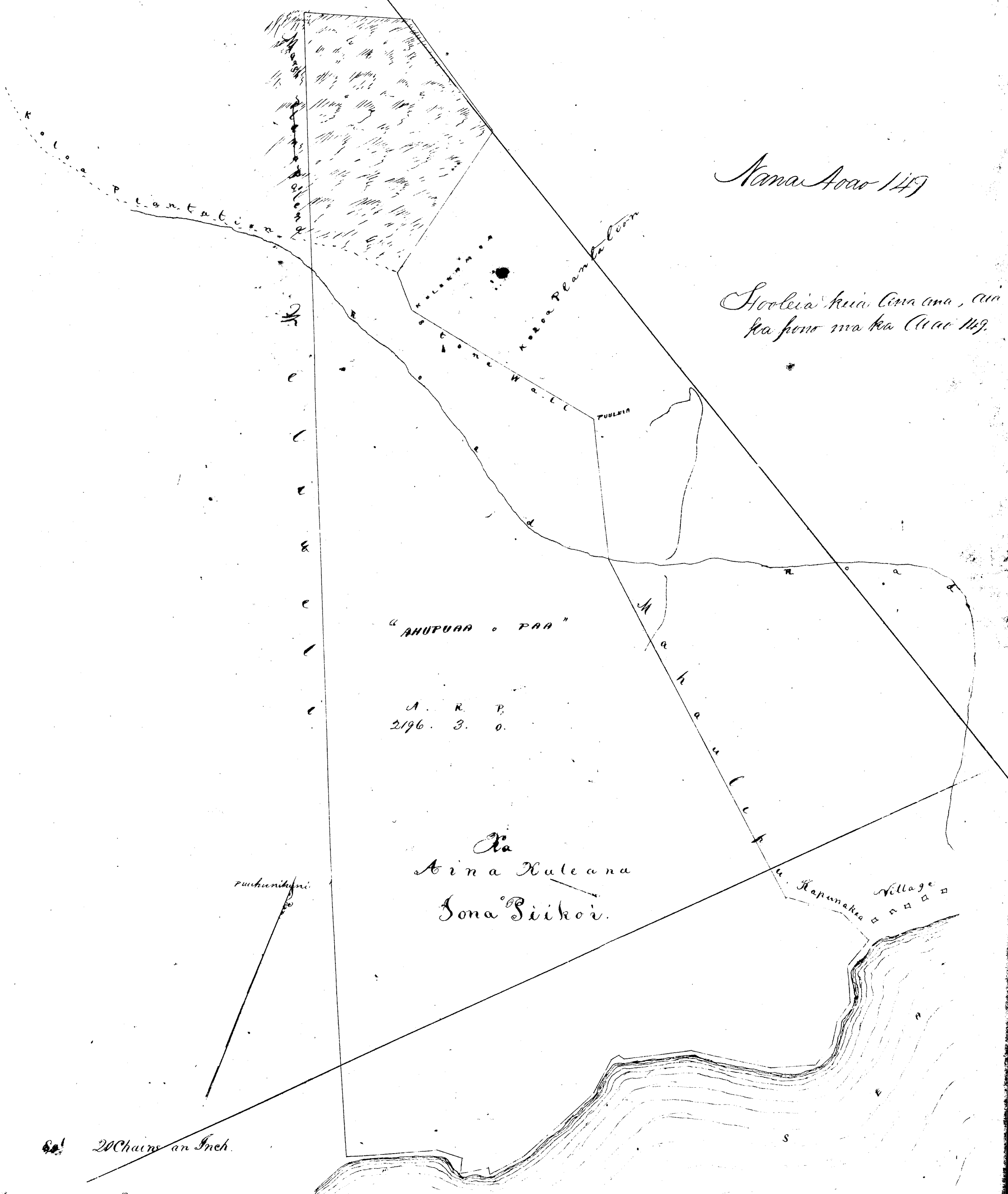

Nana Aooa 149

Hooleia Kua Aua ana, au
 ka pono ma ka Aua 149.

Ketu 1865 Tana Tikoi

Apana 3

Ua kii mai oia me kina wahi ma Mikida, he *Hikina* ma ke *Apana* o *Kamecho* *Hooupaoko*.
 ma ka *Moku* *o* *Cahu*; me ka mea, ua lea ia ia kii wahi no ke *Mi* *Kamechana* III mai i
 ka *Makalo* *oia* *ana* i ka *M.H.* 1848, a ua nolu kaka oia a hiki i kii manawa.

Oia ka maku i hooke noi me *Tana* *Tikoi*; he kuleana he kina malalo o ke *Ar* *Udio*. Ima
 e uku mai oia i ke ke *Mupuni* *hapaha*; alaila, ua kupsue ia ia ka *Palapala* *o* *Ke* *Mo* *Ho*. Ima
 na kuleana o na kanaka maloko. Ua hooke aku maku i kii kuleana mamali i na olelo o
 ke *Kanawai* *hoo* i *hoo* *oia* i ka la 19 o *Aug* *M.H.* 1852, i fili ana i na "*Kamehiki*."

Pono nae ia ia ke uku me ka hoohelele a me ka hoohele ana i ka olelo. Pono.

No ka rumi a me ke pui ana i ka olelo ma ka *Mupuni*
 No ke kope ana i ka olelo kii
 No ka palapala kii
 No ka hana ana i ka la
 No ke kope ana i na olelo a na hiki
 No ke ana ana i ka la 14 o *July* 1857.
 No ke kope ana
 No ka hoohele ana i ka olelo, *Sept* *o* *1852*.

W. L. Lee
 G. M. Robertson
 J. Kekaulahao
 Isaac Li
 J. H. Smith
 Oia na palena.

Amia e A. H. Homer.

§ K.

\$ 10.00

Mi, "*Mikiola*" ma *Kamecho*, i *Hooupaoko*, *Cahu*.

E hoomaka ma ke kii *Akan* *Kamechana*, a o holo ana

<i>Apana</i> 5 1/2	<i>Hikina</i>	18,50	pauna	e fili ana i " <i>Apana</i> "
<i>Apana</i> 31	<i>Hikina</i>	790	"	"
<i>Apana</i> 55 3/4	<i>Hikina</i>	536	"	"
<i>Apana</i> 3	<i>Hikina</i>	390	"	"
<i>Apana</i> 54	<i>Hikina</i>	735	"	" <i>Mupuni</i>
<i>Apana</i> 36	<i>Hikina</i>	545	"	"
<i>Apana</i> 3	<i>Hikina</i>	510	"	"
<i>Apana</i> 5	<i>Kamechana</i>	1500	"	"
<i>Apana</i> 28	<i>Kamechana</i>	460	"	"

alaila e fili ana ma ke kaa o ka wai mui (*Wainui*) a hiki i kahi i hoomaka i. 41 3/10 Eka.

A me ke kii. E hoomaka ana ma ke kii *Kamechana* *Akan*, a o holo ana
Apana 3 *Hikina* 18,50 pauna, alaila *Apana* *Hikina* 1600 pauna, alaila *Apana*
 12,80 pauna ma ka *Loko* o *Kapuni*.

Apana 2. 3 *Loi*. E hoomaka ana ma ke kii *Akan*, a o holo ana *Apana* 56 1/2 *Loi*, 37
 pauna e fili ana i ke *Kamechana*, *Apana* 36 1/2 *Loi*, 4, 26 pauna e fili ana i ke *Kame*, *Apana*
 63 *Loi*, 1, 33 pauna e fili ana i ke *Waimalo*, *Apana* 37 1/2 *Loi*, 100 pauna e fili ana i ke *Waimalo*
Apana 35 *Loi*, 410 pauna e fili ana i ke *Moi* a hiki i kahi i hoomaka i. 1 Eka.

Apana 3. 5 *Loi*. E hoomaka ana ma ke kii *Akan*, a o holo ana *Apana* 55 *Loi*,
 74 pauna e fili ana i ke *D. Kawana*, *Apana* 28 *Loi*, 580 pauna e fili ana i ke *D. Kawana*,
Apana 51 *Loi*, 150 pauna e fili ana i ke *W. Harbottle*, *Apana* 36 *Loi*, 570 pauna e fili ana
 i ke *Kame* a hiki i kahi i hoomaka i. 7/10 Eka.

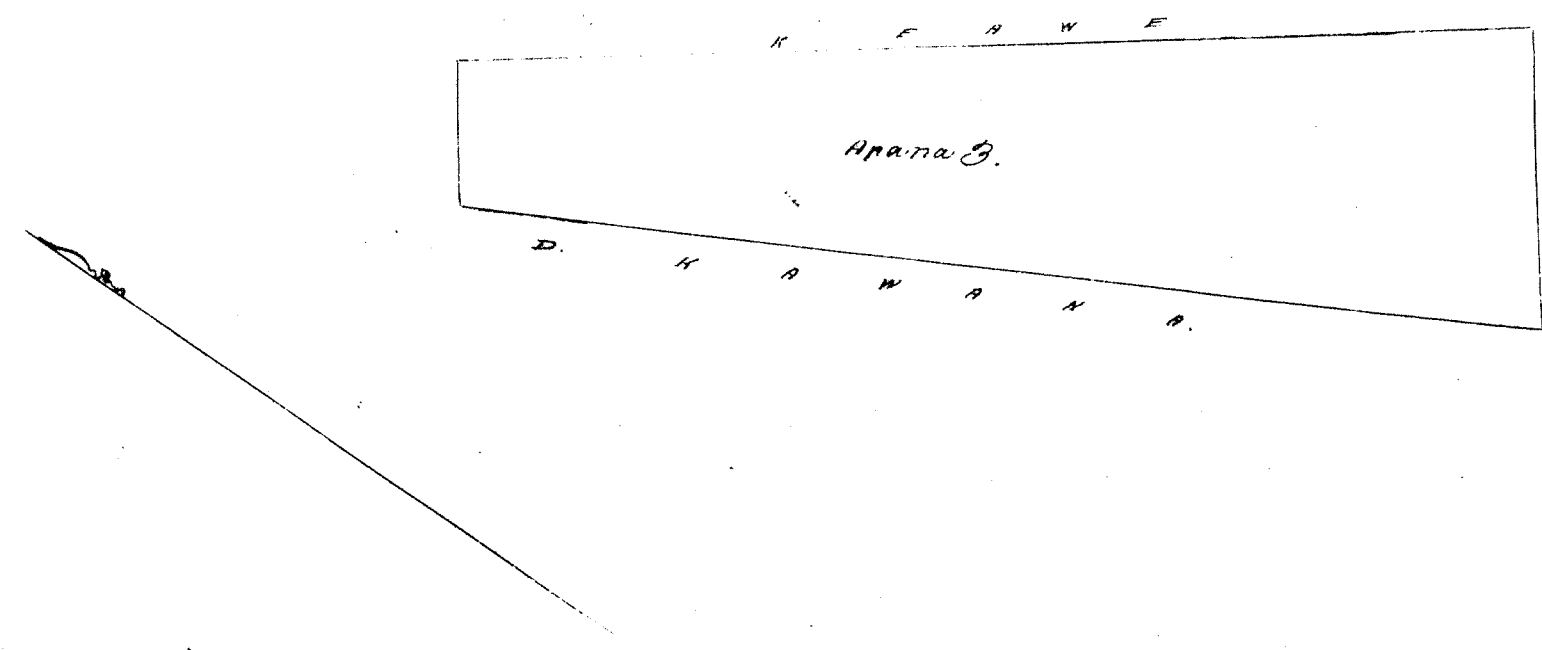

49
Olelohookakea. Ua hooho aku makou i keia kuleana o J. Pitivi ma ka aina, a he hooho
aku mai no hoi makou, he kuleana hoi kama ana ke kai o keia aina, me na mea i olelo ma
ma ma ma kei Hawaii, a i hoikeia hoi ma keia keia aina.

Ma ke kuleana ana mai o na Lani a Hona
A. L. Naititi
Kakoualeo - m. L. H.

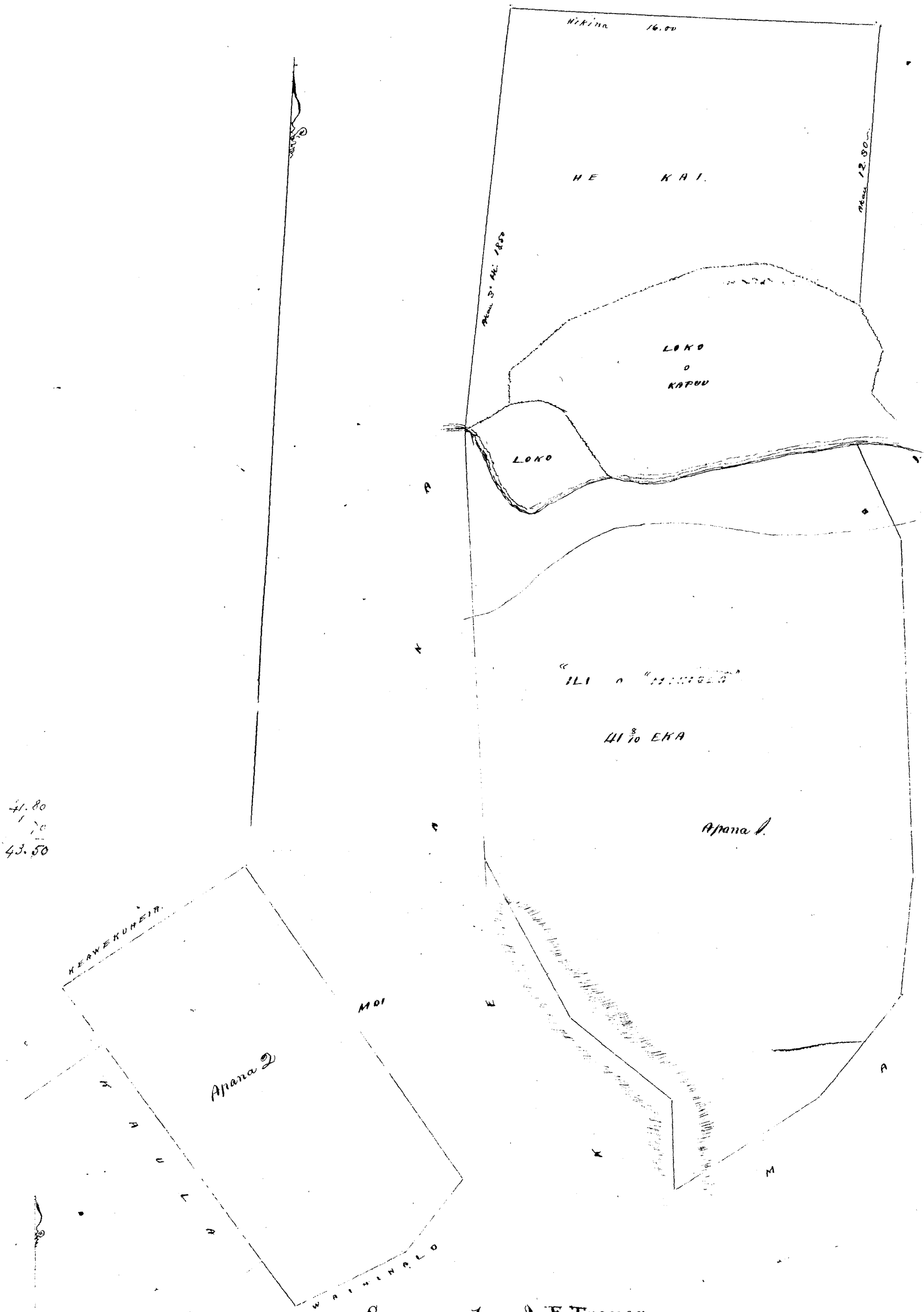

Surveyed by A. F. Turner

July 14th 1851.

Helu 10605 Iona Pitou

Apana 4

Ua kōi mai oia no kona mau wahi ma "Kaiwehe" ke Ahupuaa ma Lahaina ma
ka Mokupuni o Maui; no ka mea, ua lea ia ia keia mau wahi me ke Alii Kanwehameha III mai
i ka Mahalo aia ana i ka M.H. 1848, a ua groho keakea oleia a hiki i keia manawa.

Oia ka matakā a hooke nei no Iona Pitou; he kuleana hoi kona malalo o ke Aunā Alodio
Ana e uku mai oia i ka ke Ahupuaa hapaaka; alaila, ua hoope ia i ka Palapala Oka Alodio. Hoo mas ma
kuleana o ma kamaaka maloko. Ua hooke aku matakā i keia kuleana mamuli o ma olelo o ke Kanawai
hou i hoohele ia i ka la 19 o Iune M.H. 1852, a pili ana i ma "Konehiki".

Iono mas ia ia ke uku no ka hookelelele a ma ka hoohele ana i ka olelo. Penei:-

W. L. Lee

G. M. Robertson

J. H. Smith

J. Kakaubaho

Loane K.

Oia ma palena.

No ka auni a me ke pā ana i ka olelo ma ka Nupepa.

No ke kope ana i ka olelo kōina

No ka palapala kōi

No ka hana ana i ka la

No ke kope ana i ma olelo a ma hōke

No ka hana ana i ka la 7 o Feberuari 31 o Mar. 1852.

No ka hoohele ana i ka olelo. Sepatemaba 21, 1852.

No ke kope ana

No ka hoohele ana i ka olelo Sepatemaba 21, 1852.

Anaia o L.P. Ma.

Ken.

10.00

Makala 1.

He ana ana i ke Ahupuaa o "Kaiwehe" ma Lahaina, Mokupuni o Maui (no Iona Pitou.)

E hoomaka ana ma ke kōi Hema o keia aia ma kahi i pili ai i ke Alani a me ka Hale
mai, oia ka Pahale o Kuakini, a e hōle ana Akaw 51° Hikina 2, 38 Kaul. ma ke Kuakini, - Akaw 52°
Hikina 3, 41 Kaul. ma ke Kuakini, - Akaw 21 1/2° Komohana 1, 61 Kaul. ma ke pōalima, - Akaw 63 3/4°
Hikina 0, 31 Kaul. ma ke pōalima, - Akaw 29 1/4° Komohana 3, 48 Kaul. ma ke I. K. Kaiwehe, - alaila
Hema 50° Komohana 6, 74 Kaul. ma ke Hema, - Hema 45 3/4° Hikina 0, 50 Kaul. ma ke Halekula,
alaila Hema 50° Komohana 1 Kaul. ma ke Halekula a hiki i ke Hana i pili ai, alaila Hema
45 3/4° Hikina 4, 18 Kaul. ma ke Alani a hiki i kahi i hoomaka ai

Oia ka ili o keia Ahupuaa 3 Eka, 1 Roda, 3 Roda.

Anaia ma Lahaina, Feberuari 7, 1852.

Makala 2.

He ana ana i kekahi Apana aia o Iona Pitou ma ke Ahupuaa o "Kaiwehe"
ma Lahaina, Maui. He Paika aia kōi ma kahi i pili ai ma kahawai, o Hanaka laua o Kahama.

E hoomaka ana ma ke kōi Akaw o keia aia ma kahi i pili ai i kahawai a me
ka pāli, a hōle aku

Hema 50 3/4° Komohana 2, 29 Kaulakoa ma Kahawai

Hema 44 1/2° Komohana 2, 78

Hema 55 1/2° Komohana 2, 43

Hema 4 3/4° Hikina 2, 56

Akaw 32° Hikina 3, 83

Akaw 40° Hikina 1, 71

Akaw 21° Hikina 3, 60

a hiki i kahi i hoomaka ai.

Oia ka ili

3 Roda 9 Roda.

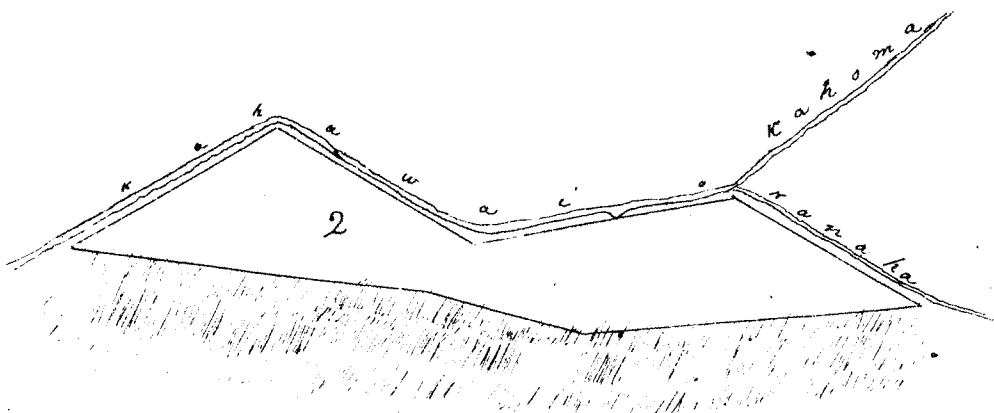

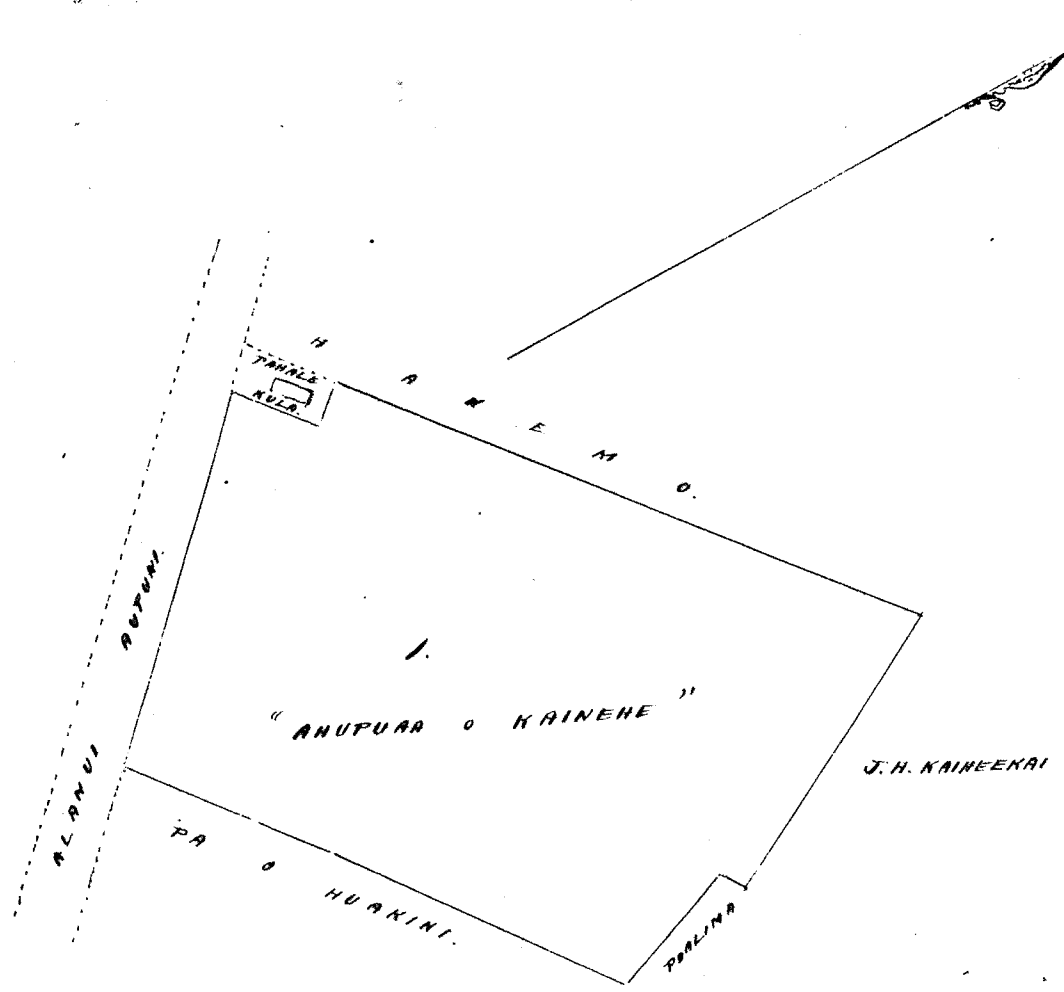

Anaia & L.P. Wa.

Kelii 10605 Iona Tukoi

Apana 5.

Ua kei mai oia no kona mau ma Kaluaopu, ke Aiaia ma ke Ahupuaa o Uaiau, ma Ewa ma ke Ahupuaa o Oahu; no ka mea, ua loa ia ia keia mau wahi no ke Alii Kamehameha III mai i ka Matala aina ana i ka M.H. 1848, a ua noho keakea oia a hiki i keia manawa.

Oia ka makou e hooko nei no Iona Tukoi, ke kuleana hui kona malalo o ke Aio Aloha. Iona e uku mai oia i ke ke Ahupuaa hapaha; alaila, ua kupaia ia ia ka Palapala Iona Aloha Kope ma ke kuleana o na kanaka malalo. Ua hooko aku makou i keia kuleana mamuli o na olelo o ke Kanawai Kouka hoolohia i ka la 19 o Iune M.H. 1852, i fili ana i na Kouka.

Iona noho i ke uku o ka hoolohia a me ka hoolohia ana i ka olelo. Ioni;

- No ka nui a me ke paai ana i ka olelo ma ke Ahupuaa.
 - No ke kope ana i ka olelo koma
 - No ke palapala kii
 - No ke hui ana i ka hui
 - No ke kope ana i na olelo a na hiki
 - No ke ona ana i ka hui
 - No ke kope ana
 - No ka hoolohia ana i ka olelo. Iona ma 21, 1852.
- W. L. Lee
 G. M. Robertson
 J. H. Smith
 J. Kakaiaha
 J. A. Si
 Eia na palena.

Ken.

8.00

Anaia & Bishop.

Ke palapala ana i ka Aiaia "Kaluaopu" ma Uaiau, Ewa, Oahu, (no Iona Tukoi)
 O hoomaka ma ke hiki Akau, i ke la ana: Iona 52 1/2 Hikiina i 4.67 kaulahao ma ka palena hula o Kumuuku. Malaila aku Iona 20 1/2 Komohana i 2.24 kaulahao ma ka palena o Kanakawailani. Malaila aku Iona 3 1/2 Komohana i 3.68 kaulahao ma Kanakawailani. Malaila aku Iona 5 Komohana i 1.82 kaulahao. Malaila aku Iona 1 1/2 Komohana i 1.90 kaulahao. Malaila aku Iona 34 1/2 Hikiina i 1.60 kaulahao. Malaila aku Iona 59 1/2 Hikiina i 3.00 kaulahao ma Kanakawailani. Malaila aku Akau 74 Hikiina i 4.35 kaulahao. Malaila aku Iona 31 Komohana i 1.72 kaulahao ma kahawai. Malaila aku Iona 6 Hikiina i 2.70 kaulahao a hiki i kahakai. Malaila aku Akau 85 Komohana i 1.00 kaulahao ma kahakai. Malaila aku Iona 37 Komohana i 5.60 kaulahao ma kahakai. Malaila aku Akau 40 Komohana i 2.50 kaulahao. Malaila aku Iona 4 1/2 Komohana i 2.00 kaulahao ma kahakai. Malaila aku Akau 35 Komohana i 1.62 kaulahao ma ka palena o Waimano. Malaila aku Akau 35 1/2 Hikiina i 4.10 kaulahao ma Waimano. Malaila aku Akau 45 1/2 Komohana i 1.56 kaulahao. Malaila aku Akau 7 Hikiina i 3.21 kaulahao ma ka palena o Kaluaohe. Malaila aku Akau 86 1/2 Hikiina i 0.60 kaulahao. Malaila aku Akau 15 Hikiina i 2.10 kaulahao ma Kaluaohe. Malaila aku Akau 50 Hikiina i 1.00 kaulahao. Malaila aku Akau 37 Hikiina i 3.00 kaulahao. Malaila aku Akau 34 1/2 Hikiina i 5.44 kaulahao ma Kaluaohe a hiki i ka hui ana.

Iona 15 7/10 na Eka.

Eia kea Afiama Kai o keia Afiama o "Kaluaopu". E homaka ma ke hiki Kikina i kahakai, e hiki ana Kema 21 Komohana, 17, 70 kaulahao ma ka palena kai no Puhii, a hiki ana Maitaita, aku Akau 21 Komohana i 5, 30 kaulahao ma ka palena kai o Waimalu. Maitaita aku Akau 21 Komohana i 15, 30 kaulahao ma ka palena kai o Waimalu a pae hou i ka Kai. He 20 ma Eka iloko oia Kai.

Ulohoakaka. He Keakeakea nei o Kakekema i ka Afiama Kula mawaho o ka faaina (no M. Kekuanaoa.) He Eka 1 ia, A ma ilawia ua Kula, alaila, hoi 14 io ma Eka o ka aina maloko o ka faa.

The above survey shewn to M. Kekuanaoa and by him approved, this 23rd day of Sept^r 1852. G. M. Robertson

Ulohoakaka. Ua hoko aku ma kou i keia Kuleana o J. P. P. ma ka aina, a ke hoko aku nei no hoi ma kou, he Kuleana no hoi hooa ma ke kai iloko o keia aina, ma ma mea i ole ia ma ma ke Kanawai, a i hoikeia hoi ma keia hii.

Ma ke kaula ana mai o ma Luma Kona

J. L. Nailili

Kuleana o ka L. K.

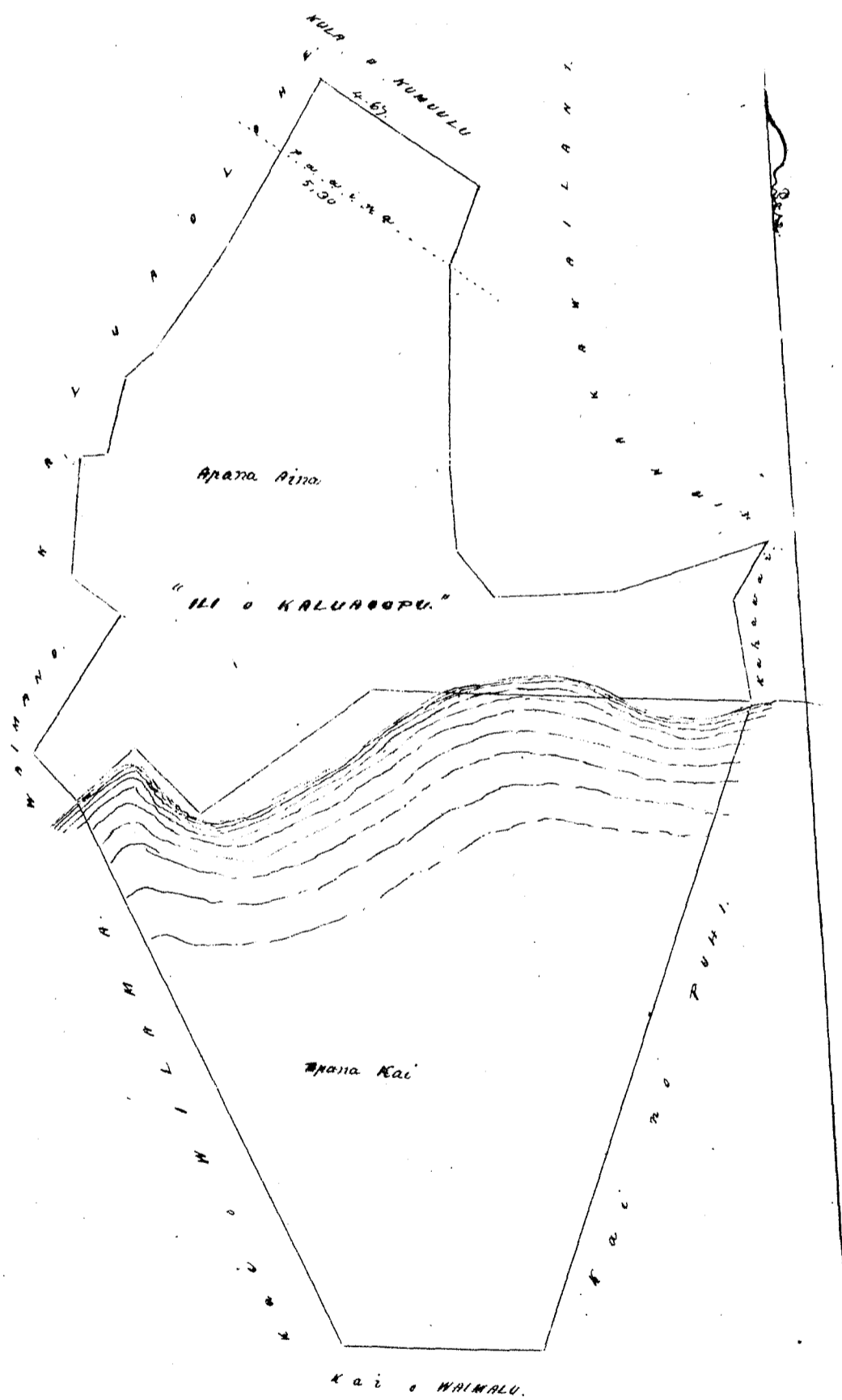

Apana 6.

Ua kovi mai oia no kona mau wahi ma "Keapuka", he Iiina ma ke Ahupuaa o Kaneohe ma Keoluapuka, ma ka Moku o Oahu; no ka mea, ua loaa ia i keia mau wahi, no ke Alii Kamahameha III. mai i ka Mahalo aia ana i ka M.H. 1848, a ua noho keakea oia a hiki i keia manawa.

Oia ka moku i hiki nei no Kamakee Piki; he kuleana hoi kona onalalo o ke Alii Kamehameha III. Ima e uku ai oia i ke ke Ahupuaa hapaha; alaila, ua kupaia ia i ka Papa o ka Pili Kuleana. Ima e uku ai oia i ke ke Ahupuaa hapaha; alaila, ua kupaia ia i ka Papa o ka Pili Kuleana. Ima e uku ai oia i ke ke Ahupuaa hapaha; alaila, ua kupaia ia i ka Papa o ka Pili Kuleana. Ima e uku ai oia i ke ke Ahupuaa hapaha; alaila, ua kupaia ia i ka Papa o ka Pili Kuleana.

Pono naco ia i ke moku ma ka hookoholo a me ka hookoholo ana i ka olelo. Penei;—

\$ Kou.

- J. Hekeaulakao
- M. Lee
- G. J. Robertson
- Louise J.
- J. H. Smith
- Oia na palena.

- No ka moku a me ke paia ana i ka olelo ma ka Ahupuaa.
- No ke kope ana i ka olelo koina
- No ka palapala kii
- No ka hana ana i ka la 8
- No ke kope ana i ka la 8 o March 1851.
- No ke kope ana i ka la 21, 1852.
- No ka hookoholo ana i ka olelo Separately 21, 1852.
- Maui a W. Webster

Pai loa \$ 10.00

Description of the boundary of the land of "Keapuka" in Kaneohe in Keoluapuka, Oahu, the property of Kamakee Piki.

Commencing on the mauka side of the property on the middle of a small island in stream as shown on Plan, the boundary runs along the property of Kapu S. 49° 13' W. 357 feet, thence S. 41° 6' W. 1362 feet, thence along the property of Kalama, S. 63° 53' W. 658 feet, thence S. 31° 50' W. 257 feet, thence N. 24° 25' W. 128 feet, thence along the property of Lihue N. 56° 8' E. 222 feet to heap of stones, thence N. 48° 22' E. 252 feet, thence N. 40° 20' E. 185 feet, thence in a bent line as shown on Plan to a point N. 41° 22' E. distant 539 feet, thence N. 32° 46' E. 456 feet, thence N. 17° 46' W. 224 feet, thence in a bent line along North bank of lead to Kalo land, bounded by the property of John Watson & Lihue N. 10° 11' E. 111 feet, thence in a bent line along bank of lead, bounded by the property of Lihue N. 33° 13' E. 260 feet, thence straight N. 12° 43' E. 227 feet, thence N. 1° 0' W. 312 feet, thence along the property of Kume N. 60° 20' E. 213 feet, thence N. 67° 13' E. 149 feet, thence across Kalo land to small ridge N. 56° 26' E. 310 feet, thence in a bent line along ridge to a point S. 73° 19' E. 261 feet, thence in a bent line along ridge & through Kalo land to a point in stream N. 80° 3' E. 245 feet, thence up along stream to commencement & contains an Area of 52 2/10 Acres

Note Only the two first bearings in description agree with the needle, all the others are at their proper angle from these two; but the needle reads two or three degrees different on some of them from the bearing given.

W. Webster.

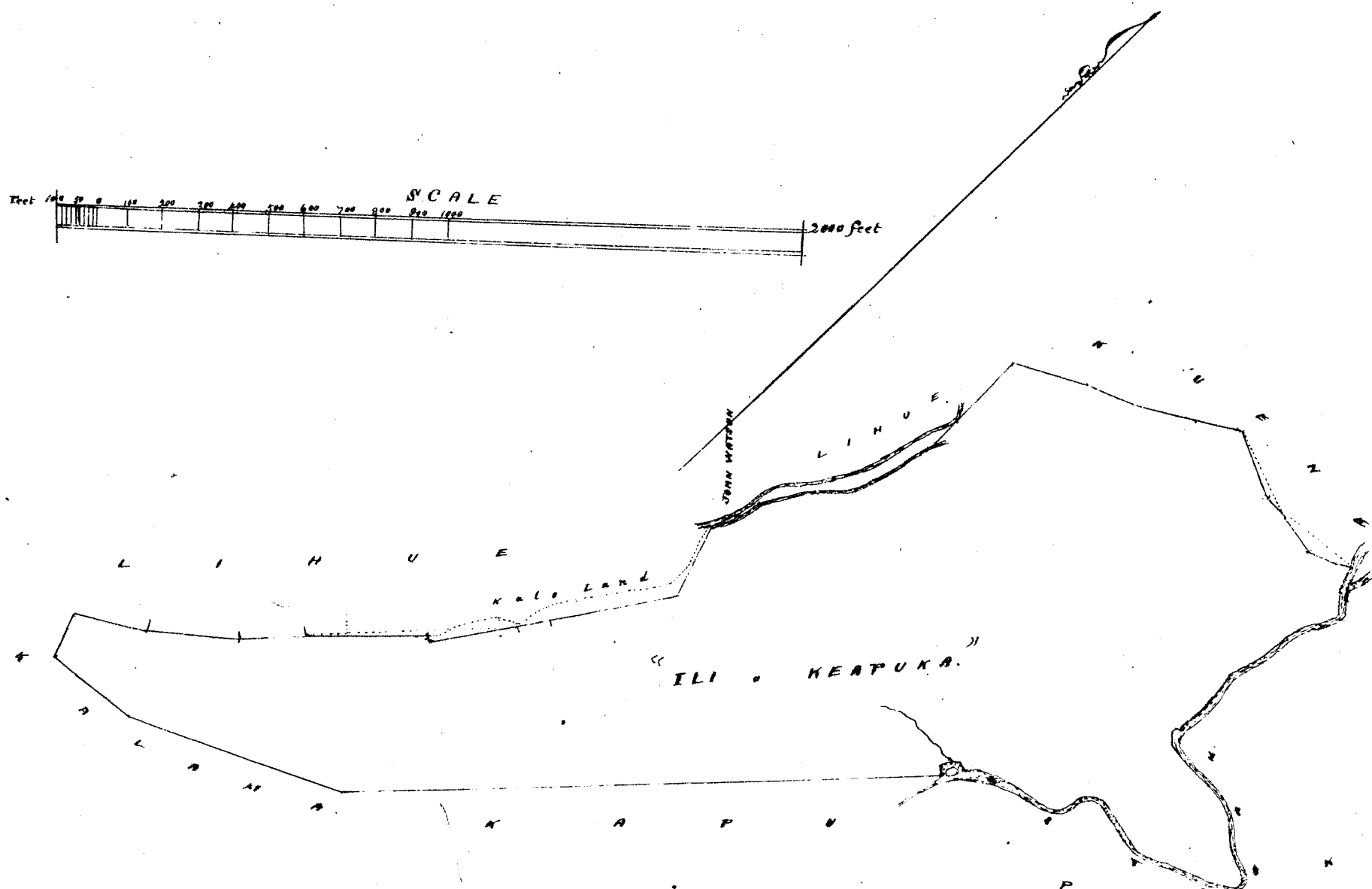

Helu 1155 Naumeke

Ua koi mai oia no kona wahi mo Waitakalulu i Honolulu ma ka Mokupuni o Oahu; no ka mea, ua hooia ia keia wahi no kona makuakane mai i ka makahiki 1835 a 6 paha, a ua nuki oluolu a hiki i ka malama o Sepatemaba 8, 1852 heakea iho la o C. Kamama, a i ka hana ana i mua o na Lina Lina, ua hooholo iho ma ka hula, he hula ana no kona malaila, a ua nuki oia a hiki i keia manawa.

Hobilia no ke hua hua ana ia mau hua.
J.S.K.

Oia ka matakou e hooke nei no Naumeke; he hula ana hoi kona malaila o ke Aho Modio. Aua e uku mai oia i ke ke Aupuni hapaha; alaila, ua hooia ia ia ka Palapala Pila Modio. Pona ma ia ia ke uku no ka hooholo kolo a me ka hooholo ana i ka olelo. Puni; -

N. Lee

No ka rumi a me ke faia ana i ka olelo ma ka hoopepea.

\$ 5.00

No ke kope ana i ka olelo koina

No ka palapala hii

No ka hana ana i ka la 7 o Augata 1848 & 8 o Sept. 1852.

No ke kope ana i ma olelo a ma hiki.

A. Kaulahao

No ke ana ana i ka la 9 o Sepatemaba 1852.

G. M. Robertson

No ke kope ana

Joanele

No ka hooholo ana i ka olelo, Sepatemaba 25, 1852.

J. H. Smith

Oia ma palena.

Anaia o P. P. Kamama.

Pauka

\$ 5.00

Aina ma Waitakalulu, Honolulu, Oahu

E hoomaka ma ke kiki Akau ma ka oia aina, e pili ana me ka aina o George Wood, a e hooi Kama 43° 45' Komohana 1.98 Kaulahao, kiki, a me Kama 52° Hikina 1.32 Kaulahao, a me Kama 57° 30' Hikina 2 Kaulahao, kiki, a me Akau 14° Hikina 1.30 Kaulahao e pili ana me ka aina o ke Komohiki a hiki i ke George Wood aina, - alaila hooi pu me ka George Wood palena Akau 66° Komohana 1.96 Kaulahao, a me Akau 26° Komohana 74 Puka a me Akau 47° Komohana, 63 Puka a hiki i kahi i hoomaka i.

37 1/2 o ka Eka, (oia hoi 453.75 Anana.)

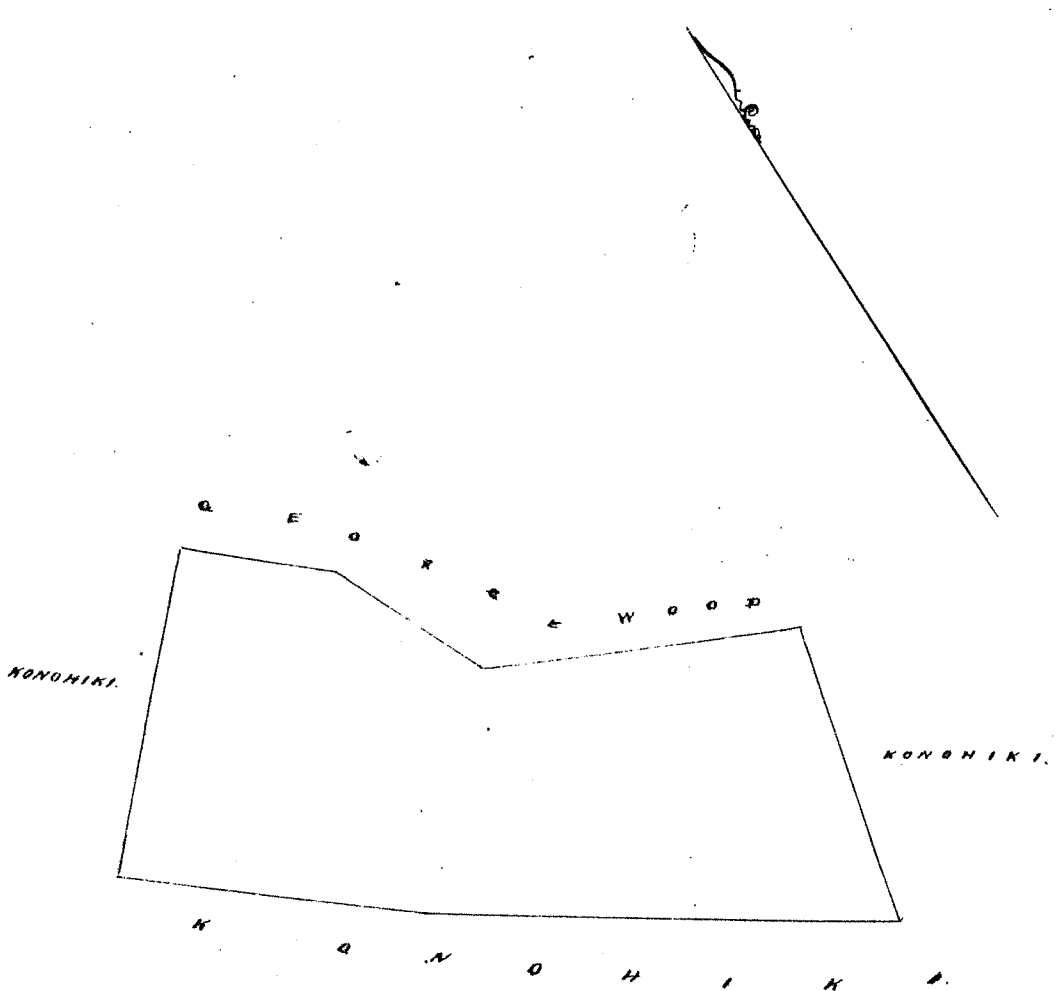

SCALE
1/4 Incha Kaulahao

Ua koi mai oia no kona mau wahi ma Hewalo i Honolulu, Oahu ma ka Mokupuni o Oahu no ka mea, ua loaa ia ia keia mau wahi no Ihu mai i ka makatitiki 1838 a ua noho keakea oia i hiki i keia manawa.

Oia ka matakou e hooko mai no Tuunui; he kuleana hoi kona malalo o ke Aro Alodio. Ima e uku mai oia i ke ke Aupuni hapaha; alaila, ua kufuni ia ia ka Palapala Olo Alodio. Ima e mau ma iaia ke uku no ka hooko lokolo a me ka hooko ana i ka olelo, Ima e...

W. L. Lee
J. Kikaulahao
G. M. Robertson
L. M. Smith
Oia ma palena.

No ka umu a me ke pua ana i ka olelo ma ka Kapua
No ke kope ana i ka olelo ke oia
No ka palapala kii
No ka hana ana i ka la 24 o Iannari 1849.
No ke kope ana i na olelo a me ke hoi ana 1/2 Aro
No ke ana ana i ka la 25 o Mei 1850 o 6 o Sepat. 1852.
No ke kope ana
No ka hooko ana i ka olelo Sepat. 25, 1852.

Pauloa \$ 7.00

Annia e A. G. Thurston o P. K. Kalama.

Aina ma Hewalo, Honolulu, Oahu.
Apana 1. Pahale ma Hewalo. E hoomaka ma ka papohaku i hooironaia ma ka ana mauwahi o ka papohaku o J. Booth ma ka auwai liliu ke hiki Kikina mauka o keia Pahale, a e holo Hema 60 Kom. 1 Haul. 56 1/2 Kapuai, a me Akau 33 Kom. 51 1/2 Kapuai, a me Akau 19 30' Hiki. 21 1/2 Kapuai, filii ana me Konoiki a hiki i ke hiki Hema mauka o keia J. Booth ma ka Hale Laau liliu, - Matala aku Akau 57' Hiki 1 Haul. 36 1/2 Kapuai a me Hema 35 Hiki. 1 Haul. 5 1/2 Kapuai ma ka papohaku o J. Booth a hiki i ka hiki i hoomaka i. 237 Anana.

Sepat. 6, 1852. Ma P. K. Kalama - I ana.

Apana 2. Pahale. E hoomaka ma ke hiki Akau mauka o keia a me ke filii ana me ke aima o Haul a me Aro, a e holo Hema 69' 15' Kom. 1 Haul. 3 1/2 Kapuai ma ka Haul, - Alaila Hema 15' 45' Hiki. 1 Haul. 40 1/2 Kapuai ma ka Kikina mauka. Matala aku 61' Hiki. 1 Haul. 11 1/2 Kapuai ma ka Haul a me ke filii ana o "Kapaala", - Matala aku Akau 18' 45' Kom. 1 Haul. 22 1/2 Kapuai ma ke Aro a hiki i ka hiki i hoomaka i. 184 Anana.

Apana 3. Pahale. E hoomaka ma ke hiki Akau mauka o keia, a filii ana me ke Kikina mauka, a e holo Hema 11' 15' Hiki 1 Haul. 17 Kap. ma ke Kikina mauka, - Alaila Hema 87' 30' Kom. 1 Haul. 62 Kapuai ma ke Haul a hiki i ke hiki Hema mauka o keia, Alaila Akau 16' 15' Kom. 34 1/2 Kapuai a me Hema 85' 30' Kom. 13 1/2 Kap. ma ke J. Pihoi, Alaila Akau 7' Kom. 46 1/2 Kap. ma ke Kikina mauka a hiki i ke hiki Akau mauka o keia, - Alaila Akau 78' 15' Hiki. 1 Haul. 48 1/2 Kap. a me Aro i ka hiki ana hema 6 1/2 Kapuai - Alaila Hema 65' 30' Hiki. 28 1/2 Kapuai a hiki i ka hiki i hoomaka i. 343 Anana.

Apana 4. Pahale. E hoomaka ma ke hiki Akau mauka o keia, a filii ana me ke aima o Kikina mauka a me Kapaala, a e holo Hema 20' 3/4 Hiki. 1 Haul. 34 1/2 Kapuai ma ke Kapaala, - Alaila Hema 44' 30' Kom. 1 Haul. 3 1/2 Kapuai ma ke J. Booth, - Alaila Hema 44' 30' Kom. 1 Haul. 3 1/2 Kapuai ma ke J. Booth, - Alaila Akau 52' Kom. 30 1/2 Kapuai ma ke Kikina mauka, - Alaila ma ke Kikina mauka Akau 16' 15' Kom. 1 Haul. 22 1/2 Kapuai a me Akau 57' Hiki. 1 Haul. 6 1/2 Kapuai a hiki i ka hiki i hoomaka i. 220 Anana.

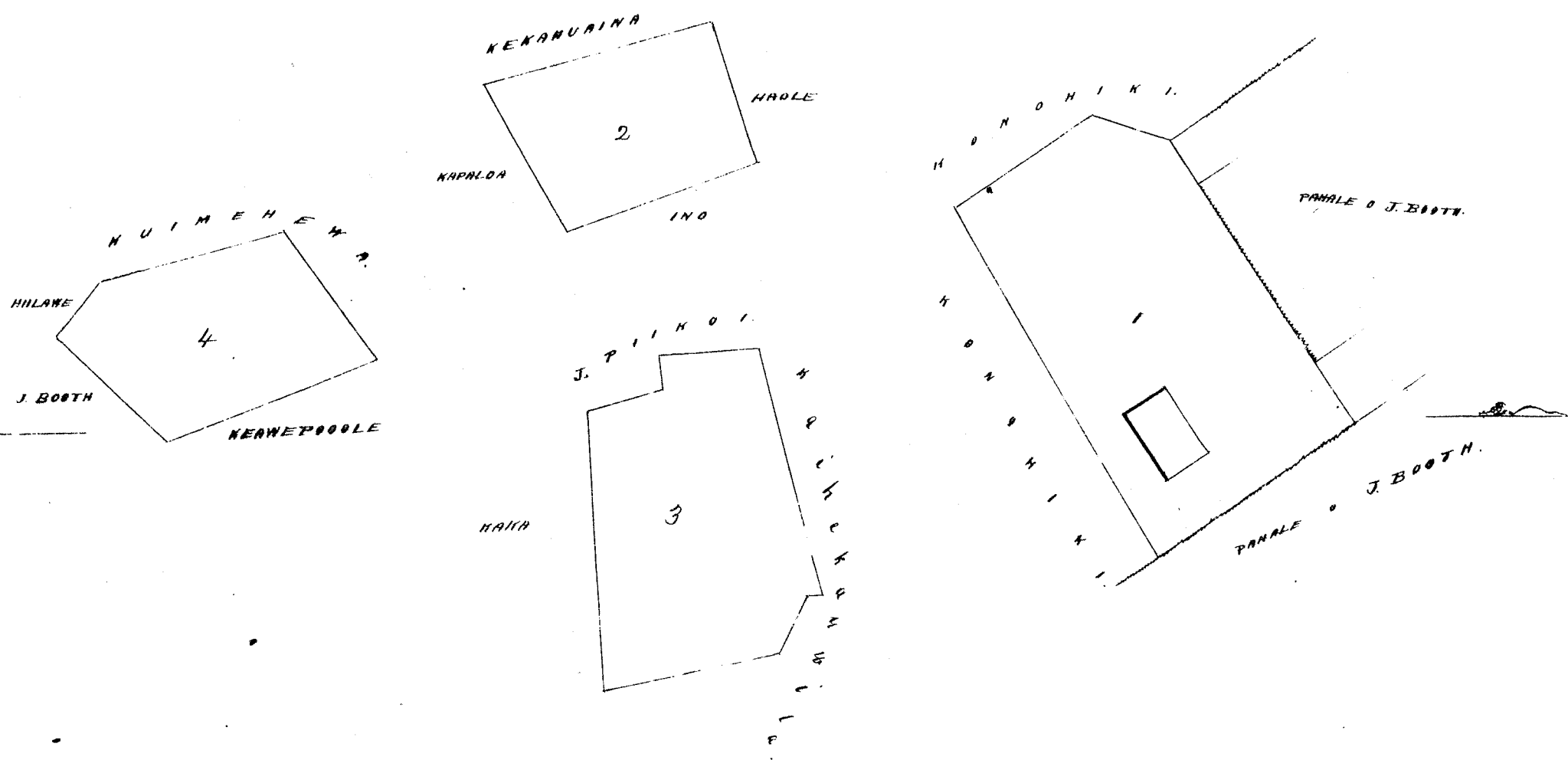

Ann ININA KAULAWA

1/2 ININA KAULAWA

Kelu 5873 Kahanaumakai

Ua koi mai oia no kona wahi ma Kahuahoe, ke Ali ana ma ke Ahupuaa o Waikiki i kona ma ke a Mokuoia i Oahu; no ke mea, ua hana ia ia koi mau wahi no ke Ali Kamehameha III mai i ke Makale ana ana i ke A.H. 1848, a ua noho keakea oia a hiki i keia manawa. Oia ka mahele e hoko nei no Kahanaumakai; ke kuleuna koi kona malalo o ke Ano Aloha. Ua e ukua mai oia i ke ke Ahupuaa hapa; aiaia, ua kupaia ia ia ke Palapala Ika Aloha. * Pono nae ia ia ke ukua no ke hoko hoko a me ke hoko hoko ana i ke olelo. Puni;

- | | | |
|-----------------|--|----------|
| W. A. Lee | No ke kupa ana i ke olelo ma ke Mokuoia. | \$ 10.00 |
| J. K. Kaulahao | No ke kupa ana i ke olelo hana | |
| G. M. Robertson | No ke palapala kii | |
| Louie Li | No ke hana ana i ke olelo | |
| J. H. Lurie | No ke kupa ana i ke olelo a ma hiki | |
| Eia na palena. | No ke ana ana i ke olelo 7 o Iulai 1851. | |
| | No ke kupa ana | |
| | No ke hoko hoko ana i ke olelo Sepatemwaha 25, 1852. | |
| | Anaia e D. Dole. | |

"Ka ana ana o kahi Ali ana, "Kahuahoe" ma Waikiki (no Kahanaumakai.)"

E hoomaka ana ma kahi pohaku kokoke i ke kuhawai ma ke kahi Komohana, a holo Kona 45' Hikiina 10.92 Kaulahao. Malaila aku Kona 47' Hikiina 27.95 Kaulahao i kahi pohaku i hoaitonaiia x ma kupa Alanui, a malaila aku ma ke Alanui Kona 47 1/2 Hikiina 16.70 Kaulahao. Malaila aku Kona 41 1/2 Hikiina 14.90 Kaulahao a hiki i ke pohaku i hoaitonaiia x; Kona 60 Komohana 26, 66 Kaulahao a hiki i ke pohaku nui i hoaitonaiia x; a Kona 61 Komohana 20, 40 Kaulahao a i ke kahi. Malaila aku Kona 13 1/2 Komohana 9.44 Kaulahao

Mulaila aku Heina 22^o Hemohana 9, 54 Kaulahao. Mulaila aku Heina 29^o Hemohana 4, 25
Kaulahao a hiki i ka hoomaka ana.

Malike oia Apana Aina 102^o Eka.

* Koe nae na kuleana o na kanaka malike. Ua hoko aku makou i keia kuleana mamuli o
na olelo o ke Kahuawai hoo i hookoloia i ka la 19^o Iune (M.H. 1852, i pili ana i ma "Hemohiki".

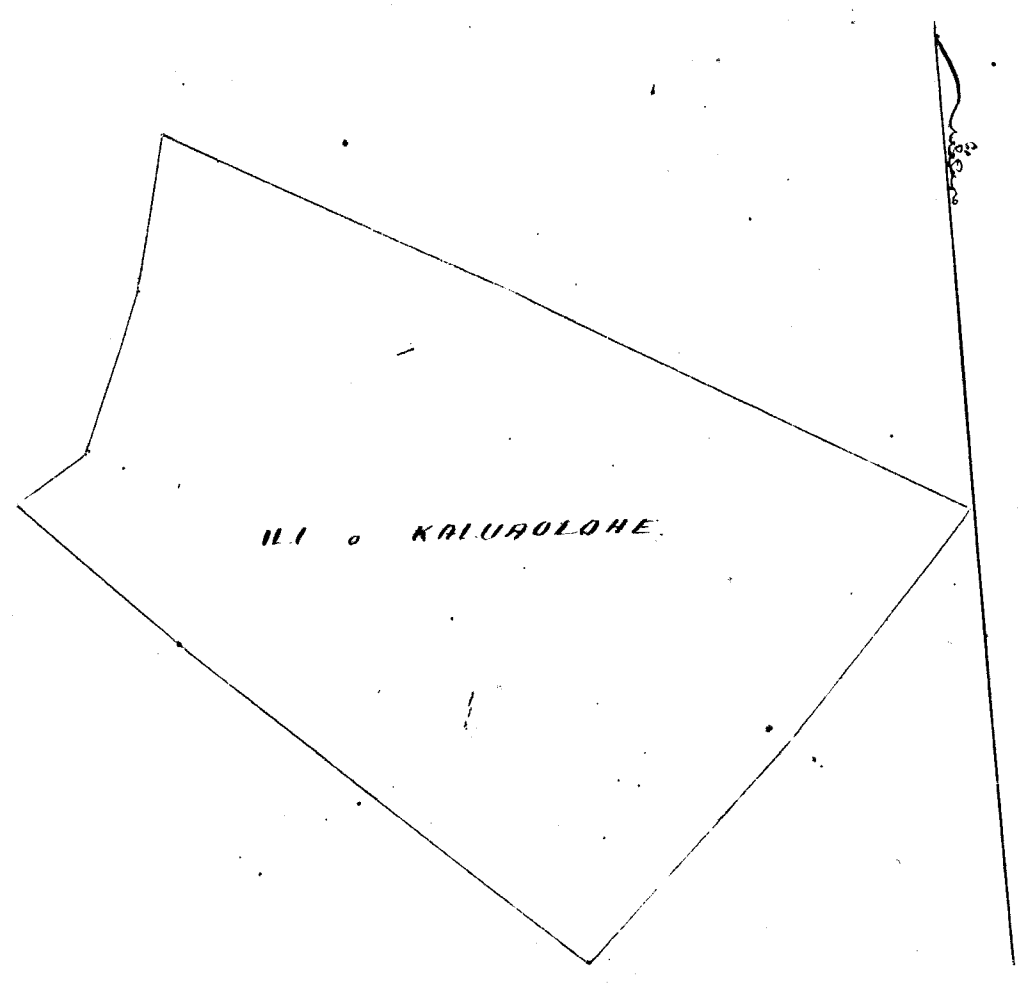

Kele 5873 Kahanaumakai

Ua koi mai oia no keia nae wahi ma "Keatua," he Aiaina ma ke Ahupuaa o Mamananui
ma Ewa, ma ka Moku oia o Oahu, ma ka mea, ua hoo ia ia keia mau wahi no ke Ahi Kamehameha III
mai i ka Mahalo ana ana i ka M.H. 1848, a ua noho keia olelo a hiki i keia mau wahi.

Oia ka wahi e hoko nei ma Kahanaumakai; he kuleana keia keia malalo o ke Ahi Kamehameha III.
Ia e ike mai oia i ka keia Aupuni, ka palapa, alaila, ua hoo ia ia ka Palapa Pala-Olelo. Koe nae na
kuleana o na kanaka malike. Ua hoko aku makou i keia kuleana mamuli o na olelo o ke Kahuawai hoo
i hookoloia i ka la 19^o Iune (M.H. 1852, i pili ana i ma "Hemohiki".

Pono mai ia ia ke ike no ke hookoloia a ma ke hookoloia ana i ka olelo. Iune.

- W. Lee No ka ike a ma ke pili ana i ka olelo ma ka Moku.
- No ke kope ana i ka olelo keia
- No ka palapa kii
- No ka hoo ana i ka la
- No ke kope ana i ma olelo a ma hoko
- No ke ana ana i ka la
- No ke kope ana
- No ka hookoloia ana i ka olelo Iepatemaba 25, 1852.

Eia ma palapa. Aina o Bishop

He ana ana i ka Aiaina o "Keatua" ma Mamananui i Ewa, Oahu.
Apana. O Keia, he Iune i keia o Keatua. E hoomaka ana ke kiki Ahan i keia ana
Heina 1^o Heina Kaulahao ma ka Moku oia. Mulaila aku Heina 22^o Heina i 4, 25
Kaulahao ma ka Moku oia. Mulaila aku Heina 21^o Heina i 8, 60 Kaulahao Malike aku Heina 24^o
Heina i 2, 10 Kaulahao ma ka palapa Pala-Olelo. Mulaila aku Heina 29^o Heina i 2, 60 Kaulahao ma
Pauau. Mulaila aku Heina 22^o Heina i 8, 60 Kaulahao ma ka palapa o Kahu. Mulaila aku
Heina 27^o Heina i 6, 21 Kaulahao ma ka palapa o Kahu a hiki i ka hoomaka ana.
Ia ike. Eka, Kaulahao hoo ana.

Apiana 2. O Moelaw, he Loko muna Poi iloko o Keahu.

E hoomaka ma ke kiki Komohana Hema, e hele ana Hema 64 Hikitina i 2, 80 kaulahao ma ke palena o Paauw. Malaila aku Akau 62 1/2 Hikitina i 1, 00 kaulahao. Malaila aku Akau 32 Hikitina i 3, 40 kaulahao ma ke palena o Kaholona. Malaila aku Akau 8 1/2 Komohana i 1, 90 kaulahao ma ke palena o Kaholona. Malaila aku Akau 59 Hikitina i 2, 00 kaulahao. Malaila aku Hema 45 Hikitina i 1, 48 kaulahao ma ke palena o Kaholona. Malaila aku Akau 39 Komohana i 2, 74 kaulahao ma ke palena o Lolei. Malaila aku Akau 58 Komohana i 5, 25 kaulahao ma ke palena kula o Kaholona. Malaila aku Hema 35 Komohana i 4, 47 kaulahao ma ke palena o Kamuliwai. Malaila aku Hema 50 Hikitina i 1, 90 kaulahao. Malaila aku Hema 50 Komohana i 4, 30 kaulahao ma ke palena o Kamuliwai. Malaila aku Hema 10 Hikitina i 3, 90 kaulahao ma Paauw a hiki i ke hoomaka ana.

Ka ili 3 Eka, 3 kaulahao huihaha.

Apiana 3. Kulekomoo, he moana iloko o Keahu.

E hoomaka ma ke kiki Akau, e hele ana Hema 58 Komohana i 1, 25 kaulahao ma ke palena o Kaholona. Malaila aku Hema 23 Hikitina i 2, 74 kaulahao ma ke palena o Kamuhahane. Malaila aku Hema 40 Hikitina i 6, 10 kaulahao ma ke palena o Kamuhahane. Malaila aku Akau 36 Hikitina i 0, 99 kaulahao. Malaila aku Akau 27 Komohana i 0, 87 kaulahao. Malaila aku Akau 36 Hikitina i 2, 19 kaulahao ma ke palena o Uluwano. Malaila aku Akau 44 Komohana i 1, 97 kaulahao ma ke palena o Kamawawa. Malaila aku Hema 66 Komohana i 0, 80 kaulahao. Malaila aku Akau 42 Komohana i 4, 60 kaulahao ma ke palena o Kamawawa a hiki i ke hoomaka ana.

Ka ili 1 Eka 7 25/100 kaulahao huihaha

Apiana 4. He Moana Kealapuu iloko o Keahu.

E hoomaka ma ke kiki Hema, e hele ana Akau 80 Hikitina i 2, 60 kaulahao ma ke palena o Kiheloa. Malaila aku Akau 22 Komohana i 10, 60 kaulahao ma ke palena o Uluwano. Malaila aku Hema 56 Kom. i 4, 00 kaulahao ma ke palena o Kaholona. Malaila aku Hema 21 Hikitina i 3, 50 kaulahao ma ke palena o Lolei i ka moa. Malaila aku Akau 68 Hikitina i 2, 00 kaulahao ma ke palena o Kapai. Malaila aku Hema 16 1/2 Hikitina i 6, 40 kaulahao ma ke palena a hiki i ke hoomaka ana.

Ka ili 3 Eka 9 100 kaulahao huihaha.

Apiana 5. He Moana Kumu iloko o Keahu.

E hoomaka ma ke kiki Hema, e hele ana Akau 52 Hikitina i 1, 54 kaulahao ma ke palena kula o Kaholona. Malaila aku Akau 24 Komohana i 9, 41 kaulahao ma ke palena o Kamakakai. Malaila aku Hema 71 Komohana i 2, 95 kaulahao ma ke palena o Lolei. Malaila aku Hema 19 Hikitina i 2, 90 kaulahao ma ke palena o Kupuika. Malaila aku Hema 49 Komohana i 3, 53 kaulahao. Malaila aku Hema 72 Komohana i 1, 69 kaulahao ma ke palena o Kiheloa. Malaila aku Hema 32 Hikitina i 1, 86 kaulahao ma ke palena o Kaholona. Malaila aku Akau 64 Hikitina i 4, 70 kaulahao ma ke palena o Kamale. Malaila aku Hema 45 Hikitina i 4, 06 kaulahao a hiki i ke hoomaka ana.

Ka ili 3 Eka 8 100 kaulahao huihaha.

Apiana 6. He Kai o Keahu. E hoomaka ma ke kiki Hikitina ma ke Hema o ke Loko Paauw, e hele ana Akau 40 Komohana i 7, 00 kaulahao ma ke palena loko. Malaila aku Akau 26 Komohana i 13, 00 kaulahao ma ke palena o Paauw. Malaila aku Hema 65 Komohana i 14, 70 kaulahao ma ke palena kai o Uluwano. Malaila aku Hema 82 Hikitina i 27, 50 kaulahao ma ke palena kai o Uluwano. Malaila aku Akau 39 Hikitina i 15, 00 kaulahao ma ke palena kai o Palas a hiki i ke hoomaka ana.

33 Eka i ke Kai.

Olelohoakaka, O ke Kai iloko o keia aino i oleloia noia. Aole e hiki ke hookes aku ia Kai e like me ke hookes ana i ke aino maoli, aea e hiki no ia Kahanaumakahi ko Moko i ia hookes iloko oia Kai e like me ke Kanawai, a e hiki no hoi ke hoomala i ke oleloia oia ma Kanawai.

Ma ke Kanawai ana mai e ma Luma Hema
Sepatemaka 22, 1852. J.L. Nailiiti

1 5. 20. 80
2 3. 3
3 1. 7. 75
4 2. 9. 19
5 3. 8. 16
17. 28. 90

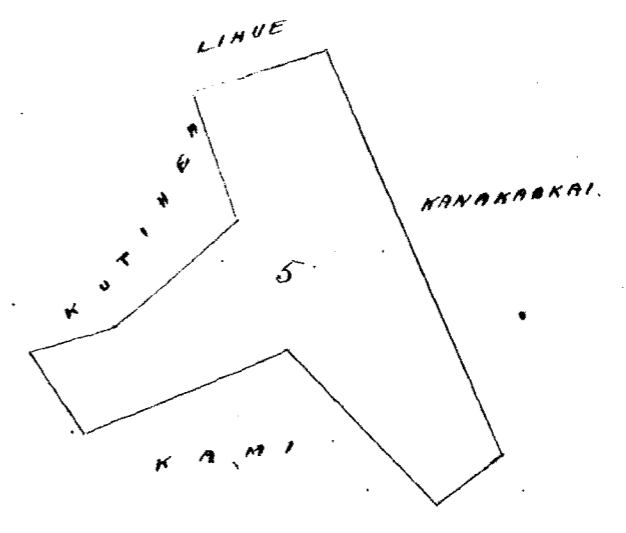
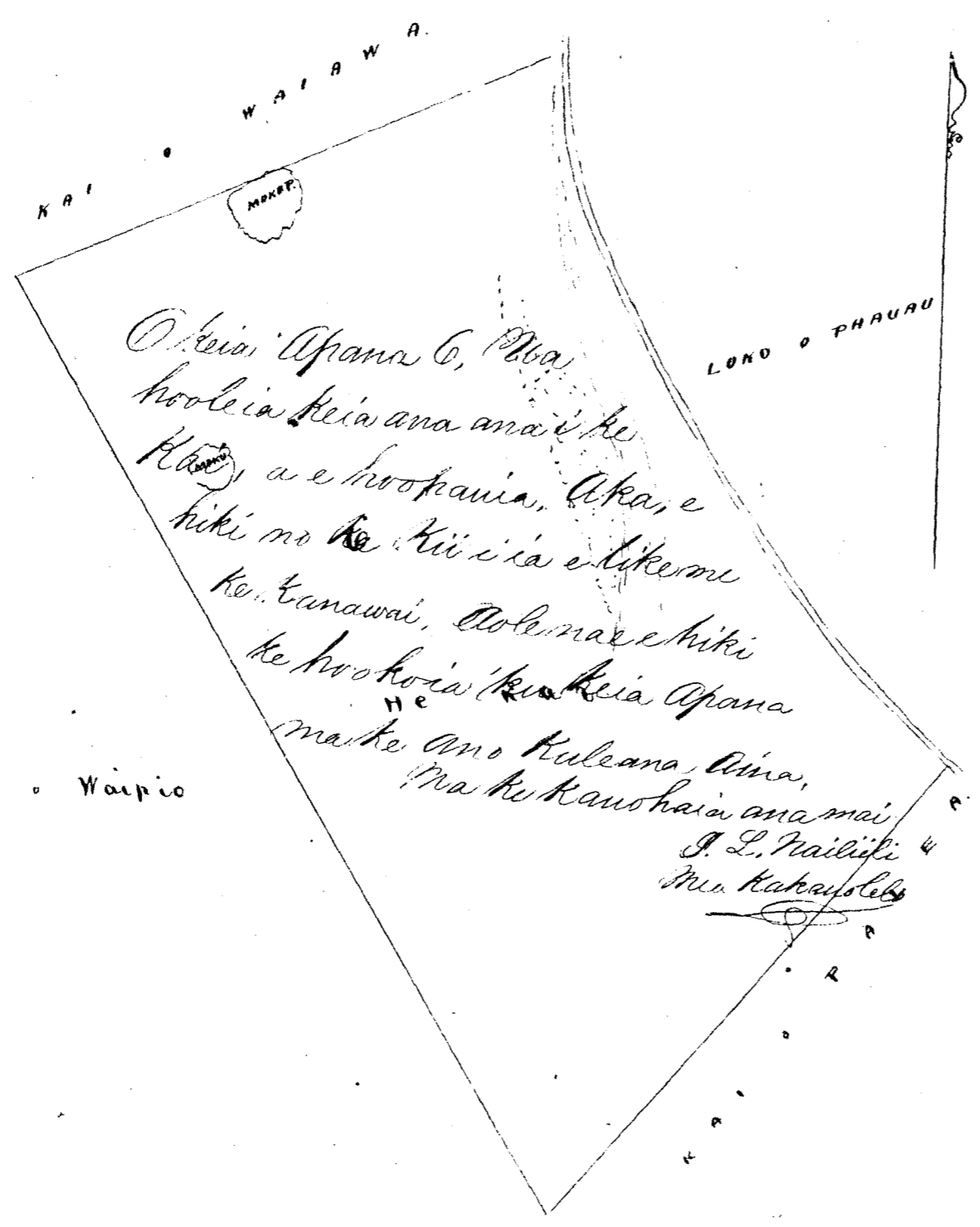
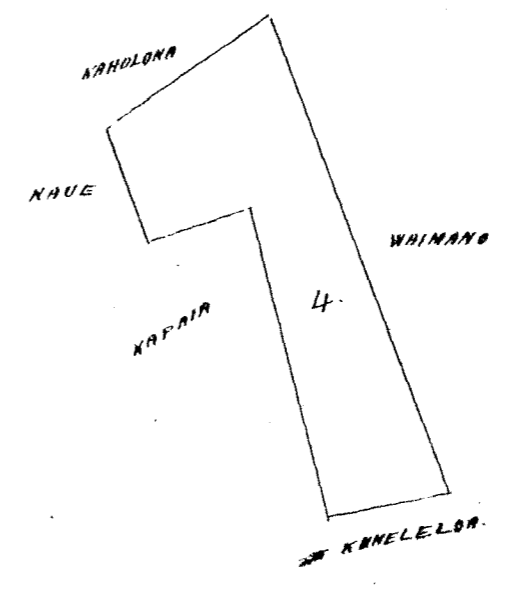
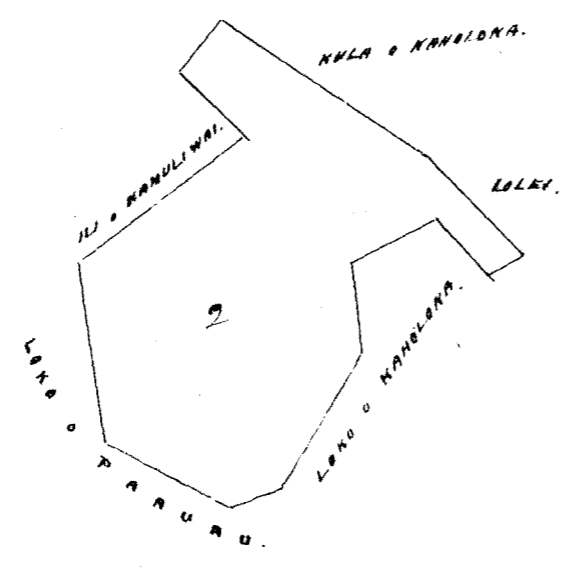
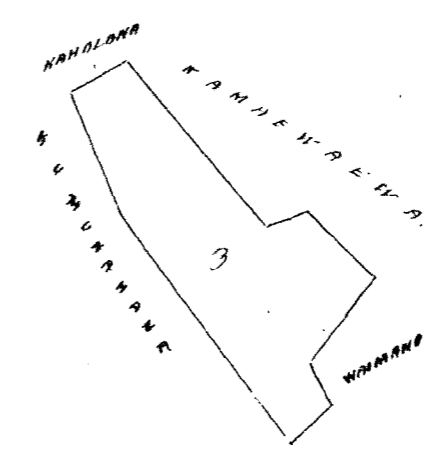
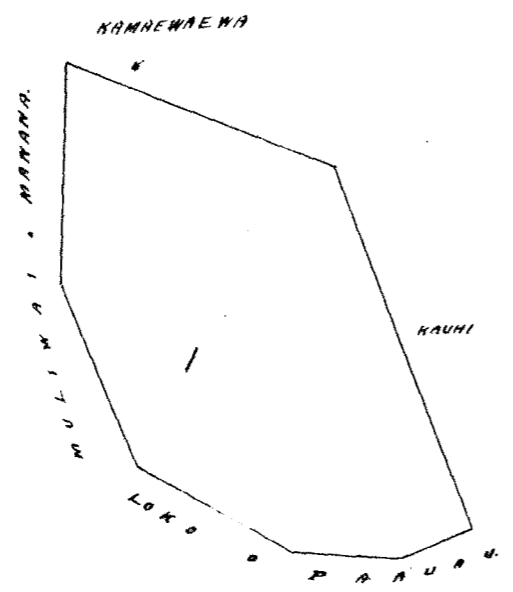

Kae o Waipio

Helu 10605 Kamakee Tiki

Apana 7.

Ua koi mai oia no kona mau wahi ana "Kewalo," ke Alii iuna ma ke Ahupuaa o Honolulu ma kona, ma ka Mokupuni o Oahu; a no ka mea, ua loaa ia ia keia mau wahi no ke Alii Kamehameha ma i ka Mahele iuna ana i ka M.H. 1848, a ua noho he mea oia a hiki i keia manawa.

Oia ka maku a hooko nei no Kamakee Tiki; ke kuleana hiki ma malalo o ke Awa Alodia. Ina e ulu mai oia i ke ke Ahupuaa kapaha; aiala, ua hooko ia ia ka Palapala Ika Ue die. Ke nua na kuleana o na kanaka maalo. Ua hooko aku maku i keia kuleana mamuli o na ole o ke Hanawai hou i hooko ia i ka la 19 o Iune M.H. 1852 o fili ana i na Honolulu. Ina nua ia ia ke ulu no ka hooko olelo a me ka hooko olelo ana i ka olelo. Penei, -

	Ne ka nuni a me ke paia ana i ka olelo ma ka Mapepa	\$ Ten
	Ne ke kope ana i ka olelo kima	
	Ne ka palapala kii	
	Ne ka hana ana i ka la	
W. Lee	Ne ke kope ana i na olelo a na hiki	
G. M. Robertson	Ne ke ana ana i ka la	
J. H. Smyth	Ne ke kope ana	
J. K. Kaulahao	Ne ka hooko olelo ana i ka olelo Sepatemaba 28, 1852.	

\$ 15.00

Eia na palena: Anaia o A. Bishop

Apana 1. Ka Anaia o Kewalo iloko o Honolulu, Oahu.

E hoomaka ma ke kiki Anaia ma na pahaku Kewalo 60 Komohana, 2 Kaulahao malalo o ka Wailele o Kapuna, a e hiki ana Kewalo 66 Komohana i 1.59 kaulahao ma kahawai. Malaila aku Kewalo 19 Hikiina i 2.50 kaulahao ma kahawai. Malaila aku Anaia 63 Hikiina i 1.39 kaulahao ma ka palena o Kaaleo i Kewalo. Malaila aku Kewalo 78 Hikiina i 1.40 kaulahao Malaila aku Kewalo 13 Hikiina i 3.00 kaulahao ma ka palena o Kaaleo Malaila aku Kewalo 52 Komohana i 4.50 kaulahao ma kahawai. Malaila aku Kewalo 5 Komohana i 5.00 kaulahao ma ka palena o Kaaleo i Kewalo. Malaila aku Kewalo 38 Komohana i 6.15 kaulahao ma ka palena o Kaaleo Malaila aku Kewalo 48 Komohana i 5.97 kaulahao ma kahawai. Malaila aku Kewalo 21 1/2 Hikiina i 3.23 kaulahao. Malaila aku Anaia 37 Hikiina i 5.40 kaulahao ma ka palena o Kope (Mr. A. Roth.) Malaila aku Anaia 15 Hikiina i 7.66 kaulahao ma ka palena o Kope. Malaila aku Anaia 34 Hikiina i 4.20 kaulahao. Malaila aku Anaia 53 1/2 Hikiina i 3.80 kaulahao. Malaila aku Anaia 26 Komohana i 6.70 kaulahao a hiki i ka pahaku o Kope. Malaila aku Anaia 26 Komohana i 6.70 kaulahao malalo o ka pahaku o Kope. Malaila aku Anaia 61 Komohana i 4.10 kaulahao a hiki i ka hoomaka ana. 8 Eka 9 3/100 Kaulahao hoomaka.

Apana 2. Ka Anaia o Kewalo iloko o Puna (ma Kamakee Tiki.)

E hoomaka ma ke kiki Kewalo i ka hiki o fili ana ma ke kiki Komohana o Auwahi-olunu, a e hiki ana Anaia 34 Hikiina i 6.55 kaulahao ma ka palena o Auwahi-olunu. Malaila aku Anaia 64 Hikiina i 5.56 kaulahao ma ka palena o Auwahi-olunu. Malaila aku Anaia 11 Kom. i 1.00 kaulahao. Malaila aku Anaia 41 Hikiina i 2.56 kaulahao. Malaila aku Kewalo 34 Hikiina i 6.07 kaulahao ma ka palena o Auwahi-olunu. Malaila aku Anaia 53 Hikiina i 10.03 kaulahao ma ka palena o Kapalena. Malaila aku Anaia 61 1/2 Hikiina i 8.19 kaulahao ma ka palena o Kapalena. Malaila aku Kewalo 42 Hikiina i 0.75 kaulahao. Malaila aku Anaia 51 Hikiina i 6.28 kaulahao ma ka palena o Kapalena. Malaila aku Anaia 35 1/2 Komohana i 5.00 kaulahao ma ka palena o Kaakunakunui. Malaila aku Anaia 35 Hikiina i 4.64 kaulahao. Malaila aku Anaia 22 1/2 Komohana i 7.00 kaulahao a hiki i ka paia ana. Malaila aku Kewalo 64 Komohana i 5.00 kaulahao ma ka palena o Kope. Malaila aku Kewalo 62 Komohana i 9.75 kaulahao ma ka palena. Malaila aku Kewalo 20 Hikiina i 3.33 kaulahao ma ka palena o Kope. Malaila aku Kewalo 68 Hikiina i 6.57 kaulahao. Malaila aku Kewalo 17 Hikiina i 0.40 kaulahao. Malaila aku Kewalo 78 Komohana i 1.80 kaulahao. Malaila aku Kewalo 15 Hikiina i 9.56 kaulahao ma ka palena ma ke kiki o Kope. Malaila aku Kewalo 62 Komohana i 0.90 kaulahao ma ka palena o Kapalena. Malaila aku Anaia 18 1/2 Komohana i 12.82 kaulahao ma ka palena ma ke kiki o Kope a hiki i ka hali. Malaila aku Kewalo 68 Komohana i 2.00 kaulahao. Malaila aku Kewalo 20 Hikiina i 3.64 kaulahao ma ka palena o Kope. Malaila aku Kewalo 29 Komohana i 3.30 kaulahao. Malaila aku Anaia 36 1/2 Komohana i 2.32 kaulahao ma ka palena o Kope. Malaila aku Kewalo 56 Komohana i 2.53 kaulahao ma ka palena o Kope. Malaila aku Anaia 32 Komohana i 0.75 kaulahao. Malaila aku Kewalo 76 1/2 Komohana i 12.30 kaulahao ma ka palena o ka ana hoomaka. Malaila aku Kewalo 61 1/2 Kom.

i 7,57 kaulahao ma ka palena aina. Kumuakula, Malaita atu Lema 32° Hikina i 3,10 kaulahao ma
ka palena aina. Malaita atu Lema 42° Hikina i 4,00 kaulahao. Malaita atu Lema 41°
Komohana i 1,28 kaulahao. Malaita atu Lema 32° Hikina i 0,60 kaulahao a hiki i ka hoomaka ana
Oia me na kuleana fu o na kamaka iloko. *LC* 50 to ma Eka.

Apana 3. Oia Mahale i keakeaia iloko. Kewalo ma Pawa. E hoomaka ma ke kiki ma
kela ma ana i Kewalo, a hele Lema 77 Komohana i 1,20 kaulahao ma ka palena o Kalokohonu. Malaita
atu Lema 25° Komohana i 7,50 kaulahao ma ka fuapohaku o Kalokohonu. Malaita atu Lema 42° Hikina i
0,72 kaulahao ma ka palena o Kewalo. Malaita atu Lema 32° Hikina i 3,15 kaulahao ma ka palena o
Kewalo. Malaita atu Lema 42° Hikina i 4,00 kaulahao ma ka palena o Kewalo. Malaita atu Lema 41°
Komohana i 1,28 kaulahao. Malaita atu Lema 32° Hikina i 0,60 kaulahao a hiki i ka hoomaka ana.
Eka 4 ¹²/₁₀₀ kaulahao huihaka

Amia e A Bishop

5. 12
8. 9. 29
50. 100. 0
1. - 4. 02
60. 100. 0
100
60. 1. 0. 1

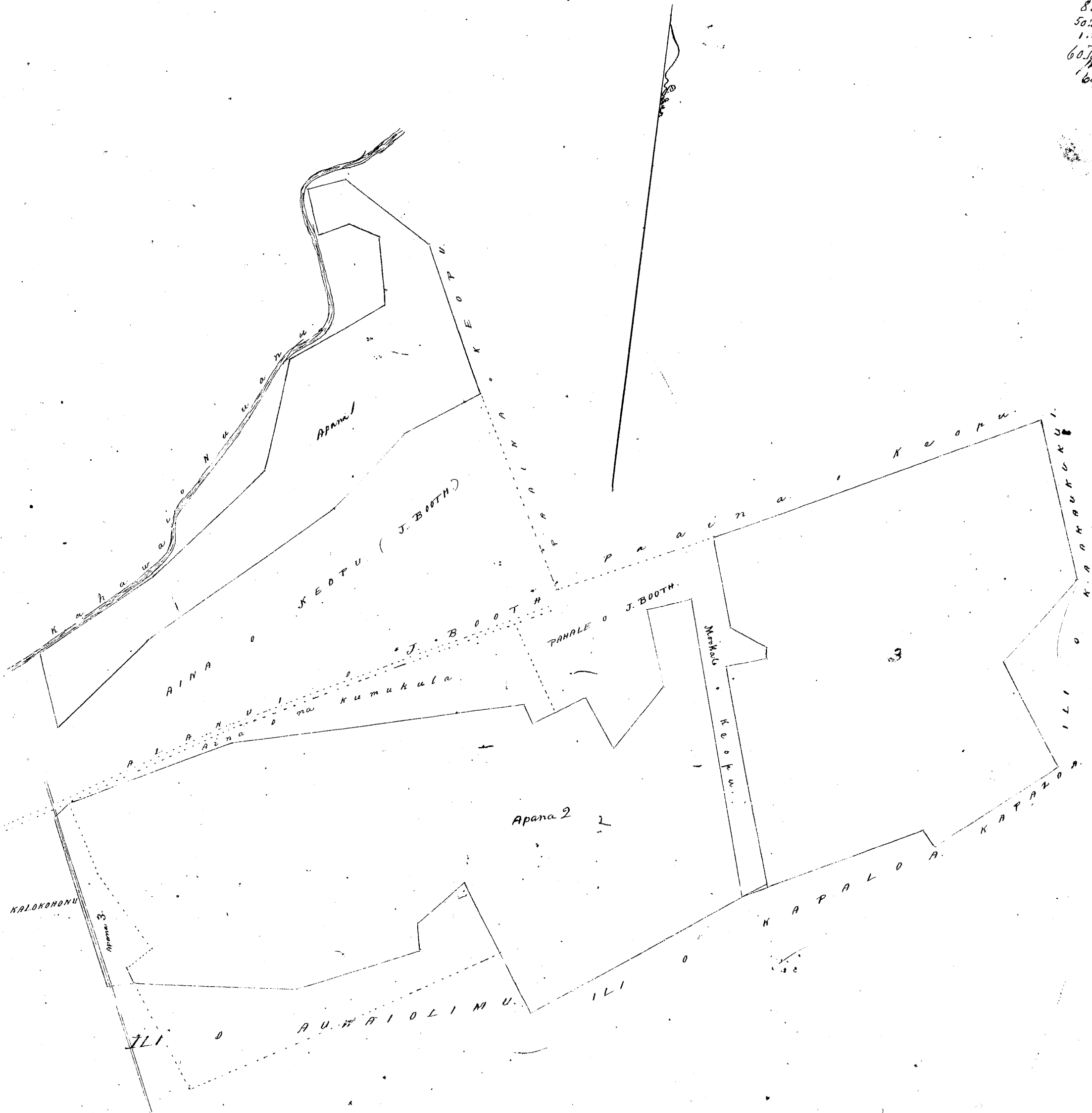

Olelohoakaka. Oka Apana 3 o keia hui malama nei i keakeaia i. Ua hele mai ma ana elua
ma ka hoopapa ana ma ia puka aina i lawe hiki e Kalokohonu, a ua hoi mai o Piki ma ana, ma Kewalo
ia hiki, a ua lawe mai i na hiki hoopapa ana ma ana Lema ma ka la 28 o Peponewaha 1852, puka hui
hiki ma ana, ua lawe mai no i hiki. A pua ka hana ana, hooholo ma Lema, "Ua ke o Hamakua Piki
i ka Apana 3 i keakeaia, a ua nele hui o P. Kekuanana ma ka ana o ke Apana." Ila ka hui
ana o na Lema Lema.

Honolulu Peponewaha 28, 1852.

B. D. Keck

Ke ana a Kewalo Ali o Honolulu, Oahu, Hele 10685 m Kamakee Pitiki.

O hoomaka ma ka Laau Niw i kaniwa ma ke hiki Komohana Akau o keia ana, e fili ana ma
 ka lili makai o ke Alanui Alii ma ke Tuleana o Makaina, a e holo i ka Hema 42° Kom. 6 ¹⁰⁰/₁₀₀ Haula, a
 i ka Hema 20 ¹/₄ Hiki 2 ⁵⁵/₁₀₀ Haul. a i ka Hema 59 ¹/₂ Kom. 5 ⁵⁵/₁₀₀ Haul. ma Kawaihaas o me Pualoalo
 a hiki i ka Laau Niw malake o ka Pa-Holoholona, - Malaila aku i ka Hema 2° Hiki. 1 ²⁵/₁₀₀ Haula me
 Puumi Aupuni a hiki i ka palena o Pualoalo o F. Pitiki, - Malaila aku i ka Akau 78 ³/₄ Hiki. 73 Panku
 a i ka Hema 7 ¹/₂ Kom. 8 ⁵⁰/₁₀₀ Haul. a i ka Hema 13° Kom. 3 Haul. ma Pualoalo o Pitiki a hiki i Kaakau-
 hukui, - Malaila aku i ka Hema 56 ¹/₂ Hiki. 30 Panku, a i ka Hema 13 Komohana 2 ⁵⁵/₁₀₀ Haul. ma
 Kaakauhukui a hiki i ka Laau Niw, - Malaila aku i ka Hema 54 ¹/₂ Hiki. 10 ¹⁰⁰/₁₀₀ Haul. a i ka Hema
 65° Hiki. 13 ⁴⁰/₁₀₀ Haul. a i ka Hema 60° Hiki. 18 ⁵⁰/₁₀₀ Haul. ma Kaakauhukui a me Kukuluwaer
 no Uirikiki a hiki i ka Laau Niw ma ka lili auwai, - Malaila aku ma ka auwai, fenei Akau 57 ³/₄
 Hiki. (ma 75 Panku Mea Lima Akau 17 Panku i ka auwai, - (Ma 1 ¹/₂ Haul. fili i ka auwai - (Ma 1 ³/₄
 Haul. haalele i ka auwai, - (Ma 3 ¹/₄ Haul. Mea Lima Akau 59 Panku i ka auwai, - (Ma 4 Haul. Mea
 Lima Akau 68 Panku i ka auwai - (Ma 5 ¹/₄ Haul. 63 Panku i ka auwai) 6 ¹⁰⁰/₁₀₀ Haul. ma ka auwai ka
 anokuma a hiki i ka Loko iloko o keia ana, - a i ka Akau 75° Hiki. 4 ⁵⁰/₁₀₀ Haul. a i ka Hema 56 ¹/₄
 Hiki. 9 ⁴⁰/₁₀₀ Haul. a i ka Hema 25 ¹/₄ Kom. 9 ⁶⁵/₁₀₀ Haul. ma Holowalu a hiki i ka palena o Kukuluwaer.
 Malaila aku i ka Hikiina 4 ¹/₂ Haul. ma Kukuluwaer a hiki i ka auwai hoomaha o me Loko o keia
 ana e fili ana me Kalio, - Malaila aku i ka Akau 44° Hiki. 6 ⁵⁰/₁₀₀ Haul. a i ka Hema, 36 ¹/₂
 Hiki. 1 ²⁵/₁₀₀ Haul. a i ka Akau 81 ¹/₂ Hiki. 4 ⁵⁰/₁₀₀ Haul. a i ka Akau 19 ³/₄ Hiki. 2 Haul. a i ka Akau
 34 ¹/₂ Hiki. 3 ⁵⁰/₁₀₀ Haul. a i ka Akau 47 Hiki. 2 ²⁰/₁₀₀ Haul. a i ka Hema 37° Hiki. 34 Panku, a i ka
 ka Akau 48 ¹/₄ Hiki. 2 ⁵⁰/₁₀₀ Haul. a i ka Akau 44° Hiki. 3 ⁵⁰/₁₀₀ Haul. a i ka Akau 54 ¹/₂ Hiki. (ma 3 ¹/₂
 Haul. faw o Kalio) 7 ³⁰/₁₀₀ Haul., a i ka Akau 61° Hiki. 2 ¹/₂ Haul. a i ka Akau 58 ¹/₄ Hiki. 2 ¹/₂ Hiki
 Haul. a i ka Akau 16 ¹/₂ Hiki. 8 ⁷⁵/₁₀₀ Haul. a i ka Akau 36 ¹/₂ Hiki. 3 ²⁰/₁₀₀ Haul. a i ka Akau 35° Hiki.
 4 ²³/₁₀₀ Haul. a i ka Akau 34 ¹/₂ Hiki. 67 Panku ma Kalio a me Kawananakoa a hiki i ka lili
 makai o ke Alanui makai o Tulakabua. Malaila aku i ka Akau 79° Kom. 29 ¹/₄ Haul. a i ka
 Akau 80 Kom. 22 ⁴⁵/₁₀₀ Haul. a ka Akau 76 ³/₄ Kom. 6 ⁵⁰/₁₀₀ Haul. a i ka Akau 74 ¹/₂ Kom. 3 ²⁸/₁₀₀ Haul.
 a i ka Akau 82° Kom. 2 ²³/₁₀₀ Haul. a i ka Akau 78° Kom. 9 ¹⁰⁰/₁₀₀ Haul. a i ka Akau 81 ¹/₄ Kom. 3 ¹⁵/₁₀₀ Haul.
 a i ka Akau 84 ¹/₂ Kom. 1 ²⁷/₁₀₀ Haul. ma ka lili makai o ke Alanui makai a me ke Alanui Alii
 a hiki i ka lili i hoomaka 'i. Malake oia ana 270 ⁸⁴/₁₀₀ Eka.

Anaia v J. P. Kalama

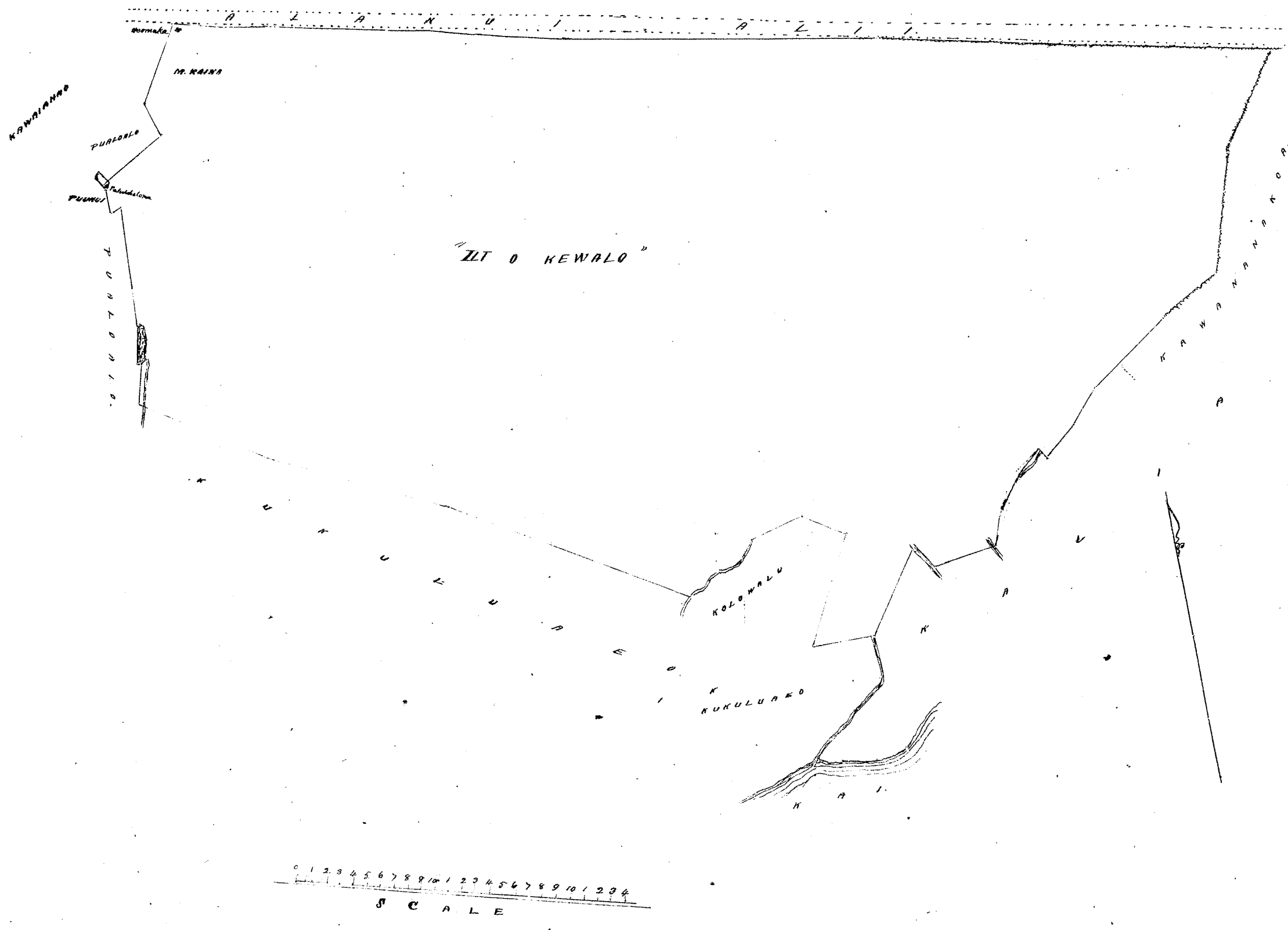

Ua hoi mai oia no kona wahi ma Hawaii ana Honolulu Aina ma ka Mokupuni o Oahu,
no ka mea ua loaa ia i keia wahi no Kahalo mai i ka manawa no e ola ana o Hinana, a ua noho
keakea oia a hiki i keia manawa.

Oia ka makou e hooke nei no Nalauyaka, he kuleana hoi kona malalo o ke Ann Alodio.
Ia e uku mai oia i ke ke Anupuni hapaha; aiaia ua kupo ia ia ka Palapala Pila Alodio.

Iono mai ia ia ke uku no ka hoolohole a me ka hoolohole ana i ka olelo. Penei, —

	No ka rumi a me ke pui ana i ka olelo ma ka Mokupuni	1	\$	Ken.
	No ke kope ana i ka olelo koina			50
	No ka palapala kii			50
W. Lee	No ka hana ana i ka la 3 o December 1849			1
G. M. Robertson	No ke kope ana i ma olelo a ma hooke 1/3 Awa			25
J. K. Smith	No ke ana ana i ka la 27 o Dekemaba 1851. Ukuia #3.			
J. Hekeubaho	No ke kope ana			50
Loansi	No ka hoolohole ana i ka olelo. Okatoba 2, 1852.			50
			\$	2.50
			\$	6.25

Oia na palena. Anaia e J. W. Makalema.

Kuleana o Nalauyaka ma Hawaii, Honolulu Aina, Oahu
E hoomaka ma ke kii Hikina maika o keia pili me ke Uaikea a me Honolulu, a holo
ma ke ke Honolulu Hema 64° 30' Komohana 3 7/100 Kaulahao i ke Kaalou; Akau 21 Komohana 1 8/100
Kaulahao i Kapalama; Akau 11 Hikina 1 7/100 Kaulahao; Akau 55 Hikina 2 Kaulahao i ka lani palena;
Hema 23 Hikina 1 22/100 Kaulahao; Akau 56° 30' Hikina 57/100 Kaulahao i ke Uaikea; Hema 27° 30'
Hikina 2 25/100 Kaulahao i ka hui o hoomaka i.

Ma ia Apama 1 2/100 Eku.

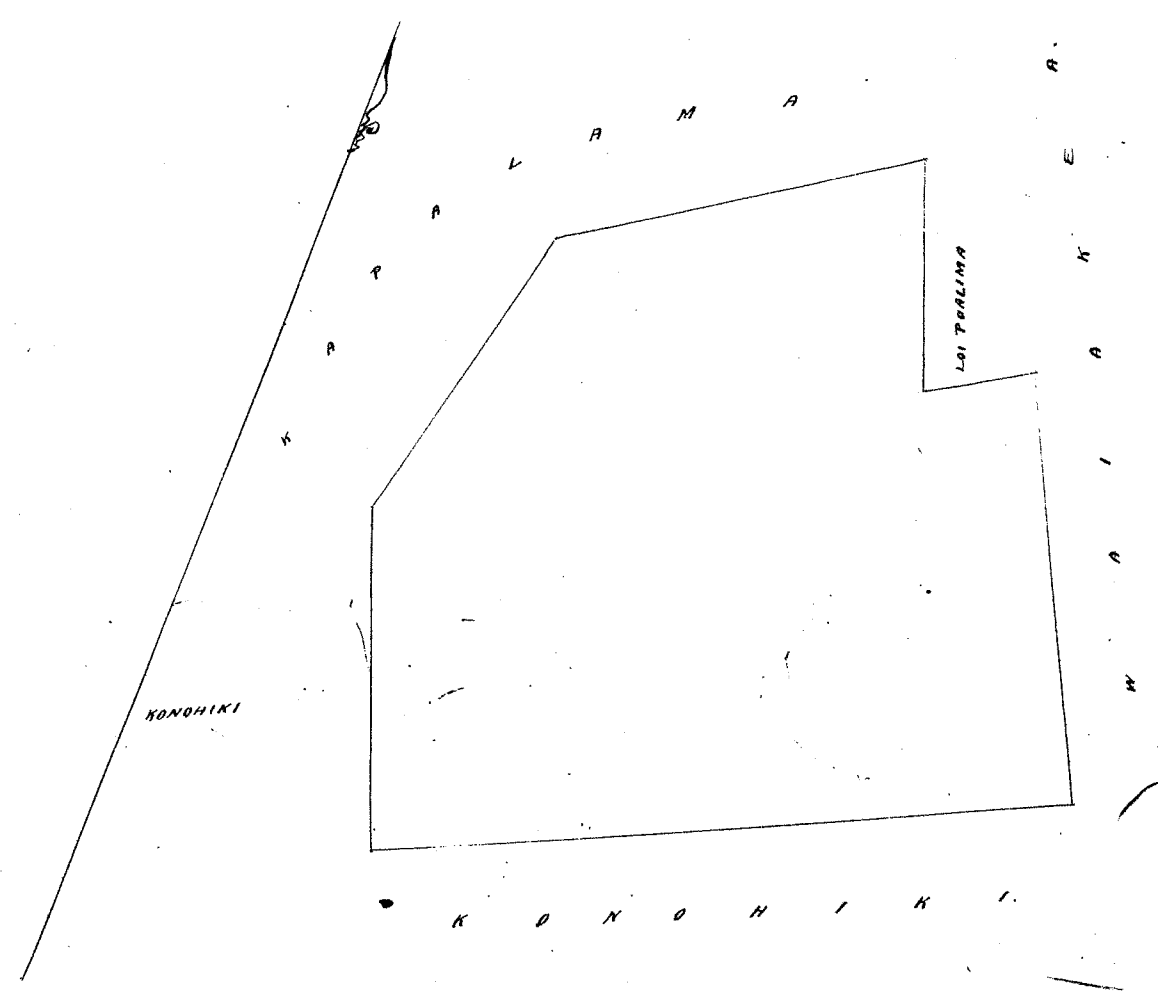

Kaulahao India.

Helu 548 Kinopu

Ua koi mai oia au koina wahi ma Kapunolo i Honolulu ma Tona ma ka Mokupuni o Oahu; no ka mea ua loaa ia ia keia wahi no Kahulumannu mai, a ua loaa hoi ia Kahulumannu no Kaikioahu mai i ka manawa o ka make ana o Kaikioahu, a ua loaa hoi ia Kaikioahu i ka manawa o ka hana ana i ka Papua o Honolulu, a ua noho kea kea oia a hiki i keia manawa.

Oia ka makou o hooke nei no Kinopu; ke huleana hoi koina malalo o ke Ano-Alodio. Ina e uku mai oia i ke Aupuni hapaha; alaila, ua kumpu ia ia ka Palapala Peta Alodio. Iono mai ia ia ke uku no ka hookeolokolo a me ka hookeo ana i ka olelo. Ionei,-

	No ka rumi a me ke fari ana i ka olelo ana ka Mapepa.	\$	Ken.
	No ka kope ana i ka olelo koina		
	No ka palapala kii		
G. M. Robertson	No ka hana ana i ka la 27 o Okatoba 1847.		
W. Ke	No ka kope ana i ma olelo a ma hiki i ka		
J. Kapaunaha	No ke ana ana i ka la o Epatepema 1852.		
J. J. Smith	No ka kope ana		
	No ka hookeo ana i ka olelo Okatoba 4, 1852.		
Oia ma palewa.	Anaia i S. Palama	Pau loa	\$ 5.00

Pahale ma Honolulu Kulanakauhale, Oahu.

E hoomaka ma ka pahu i kuhikuhia e G. M. Robertson ma ka lili Aha o ke Ala Palaki, a e holo i ka Aha 54 Hikiina 8 1/2 Kapwai, a Aha 58 Hikiina 26 1/2 Kapwai ma ke Ala Palaki. Alaila Aha 35 Komohana 50 1/2 Kapwai ma ke Kahaukai, Alaila Aha 55 1/2 Komohana 28 1/2 Kapwai ma ke Napahi a hiki i ka lua o ka pahu i kuhikuhia e G. M. Robertson Alaila Aha 28 Hikiina 53 1/2 Kapwai ma ke Kahorowaha e mahalo like ana i ka pumawai i hiki i kahi i hoomaka i.

Ma keia Pahale 56 7/8 Aha.

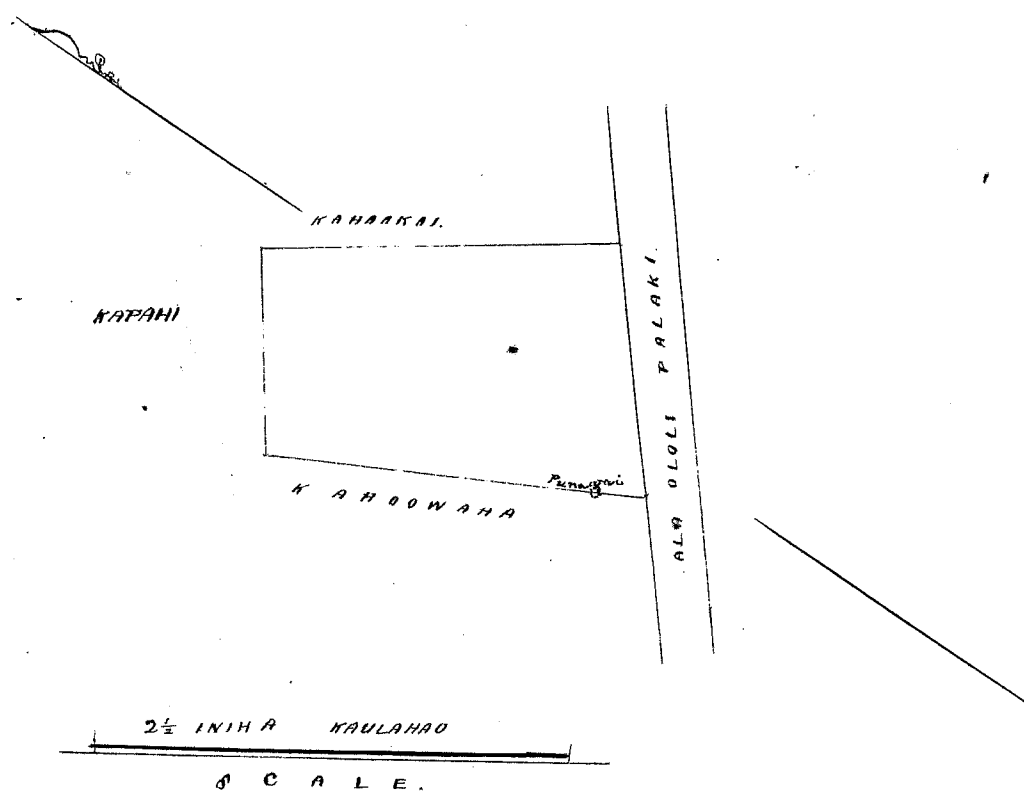

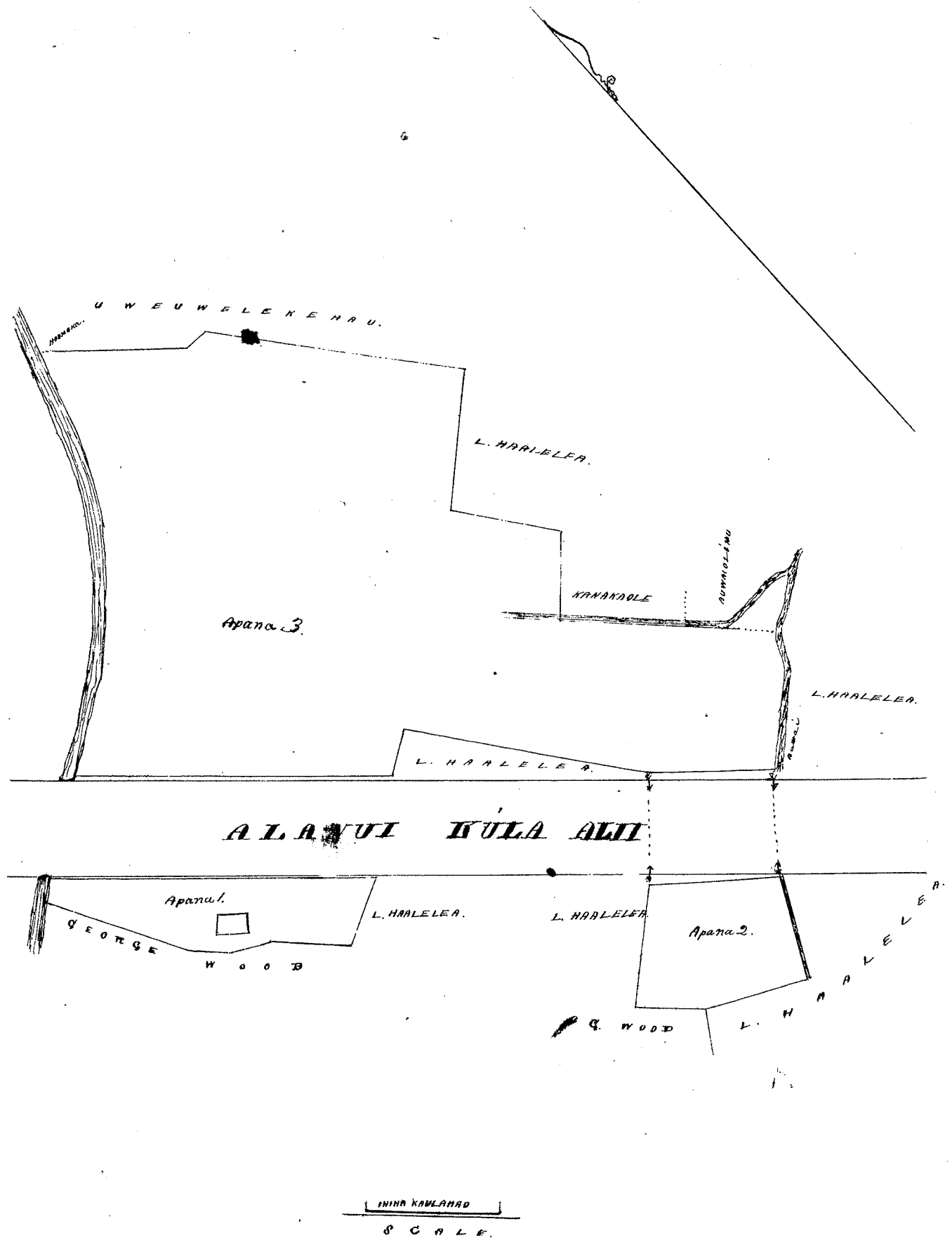

Mai Oas 66 Vol. 1 mai Helu 30 Kahowaha

Ua hoi mai oia no kona mau wahi Pahale ma Honolulu ma kona mau wahi (Pookunani Oahu, ma ka mea, ua loaa ia ia keia mau wahi no kona mau maua mai i ka manawa no i Kamehameha, a ia manawa no, ma ka mahe mai mahe o Kahowaha, a ili no kaia no Kahowaha ka lona heiki, a ke moke nei no Kahowaha mahe i heiki i keia manawa. O Kingo mau ka mea keia i keia wahi manawa heiki i ka la 17 o Sepatemaba 1852 iho nei. No ka mea, ua hooono kuleana mai mohe oia no ka wahi o keia pa o Kahowaha, a ua loaa no hoi ia Kingo mai kona mahekaheka mai o Kahowaha, a no kaia wahi mai hoi ke Kahowaha mahe mahekaheka, oia ka hana ana o ka Pahe o Honolulu manawa ahe o ka holo ana o Liholihio ma i Peritania i ka mahekaheka 1823. A i ka la 17 o Sepatemaba 1852 iho nei, ua hooono fono hon ia keia imua o ma Lina Lina iwaena o ma ana elua, a ua hele kaia o ma Lina Lina a mahekaheka, a kaawale ke Kahowaha, a kaawale ke Kingo, a ua fono keia mahekaheka ana a ma keia hooono ana i ma ana elua, a ua hooono keia hon ole a heiki i keia manawa.

Oia ka mahekaheka hooono nei no Kahowaha, ke kuleana hoi kona mahekaheka o ke Ana Aloha, ma i wahi mai oia i ke ke Aupuni hooono; aiaia, ua hooono iaia ka Palapala Aloha Aloha. Fono mai ia ia i wahi no ka hooono keia a ma ka hooono ana i ka olelo. Penei,-

	No ka imua a ma ke fono ana i ka olelo ma ka Aupuni	\$ 50
	No ke kope ana i ka olelo hono	50
G. M. Robertson	No ka palapala keia	
W. A. He	No ka hana ana i ka la 16 o 30 o Iune 1846 o 17 Sept. 1852.	1
St. Mitt	No ke kope ana i ma olelo a ma hoi ke	1
J. Kekaulaha	No ke ana ana i ka la 17 o Sepatemaba 1852.	
J. A. de	No ke kope ana	
	No ka hooono ana i ka olelo October 4 th 1852.	50

Eva ma palema.

Anaia e S. Kalama & A. F. Turner.

Ahana 1. Pahale ma Honolulu. E hoomaka ma ke kahi Hema maikai o keia Pahale, a e holo aha i ka Ahaan 66° 30' Hiki. 149 1/2 Kapwai ma ke Kalukini; - Alaila Ahaan 40' Kom. 4 Kapwai a i ka Ahaan 61' Hiki. 9 Kapwai ma ke Komake; - Alaila Ahaan 31' Kom. 58 1/2 Kapwai ma ke P. F. Manini a hiki i ke Alamui Aufermi; Alaila Hema 55' Kom. 97 1/2 Kapwai ma ke kahi o ke Alamui a hiki i ke kahi hoo, Alaila ma ke kahi hoo mui a hiki i ke kahi i hoomaka i

June 5, 1851.

164 Ahana 25 Kapwai

A. F. Turner
Ka mea ma

Ahana 2. Pahale ma Honolulu. E hoomaka ma ke kahi i kuhikuhia e S. M. Robertson ma ke kahi ana o Kirofuu, ma ke kahi Ahaan o ke Ala olohi Palaki ke inoa, ke kahi Hiki maikai o keia Pahale, a e holo i ka Hema 54' Kom. 67 1/2 Kapwai ma ke kahi Ahaan o ke Ala olohi Palaki; Alaila Ahaan 32 1/2 Kom. 54 1/2 Kapwai ma ke P. Kom. - Alaila Ahaan 55 1/2 Hiki ma 71 1/2 Kapwai ma ke Kapahi a hiki i ke kahi i kuhikuhia e S. M. Robertson; - Alaila Hema 28 Hiki. 53 1/2 Kapwai e holo ana ma ke Kirofuu e matete like ana i ke punawai a hiki i ke kahi i hoomaka i.

102 1/10 Ahana

September 17, 1852

S. Kalama & A. F. Turner

Ma hoolia keia ana ma ke kahi hoo, aia ke kahi ma ke Ahaan 180, o ke Ahaan a S. Kalama.

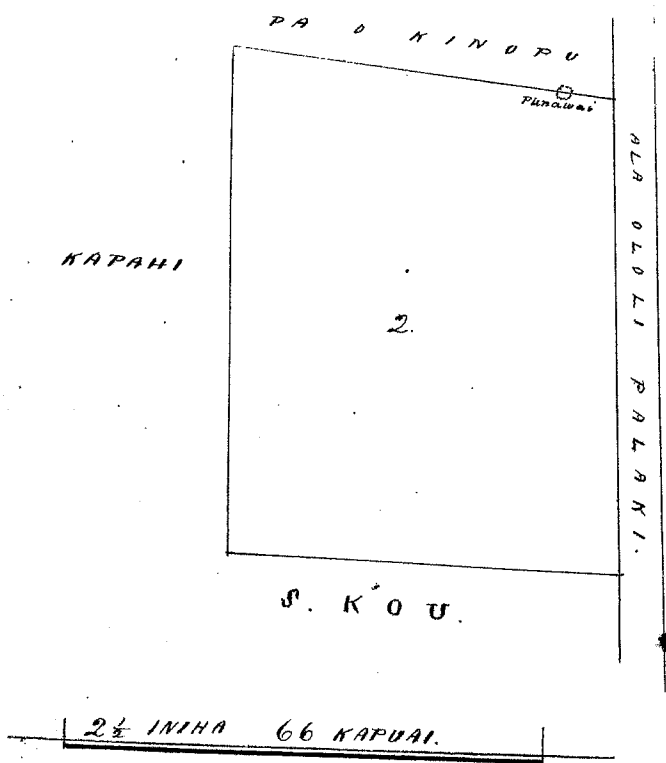
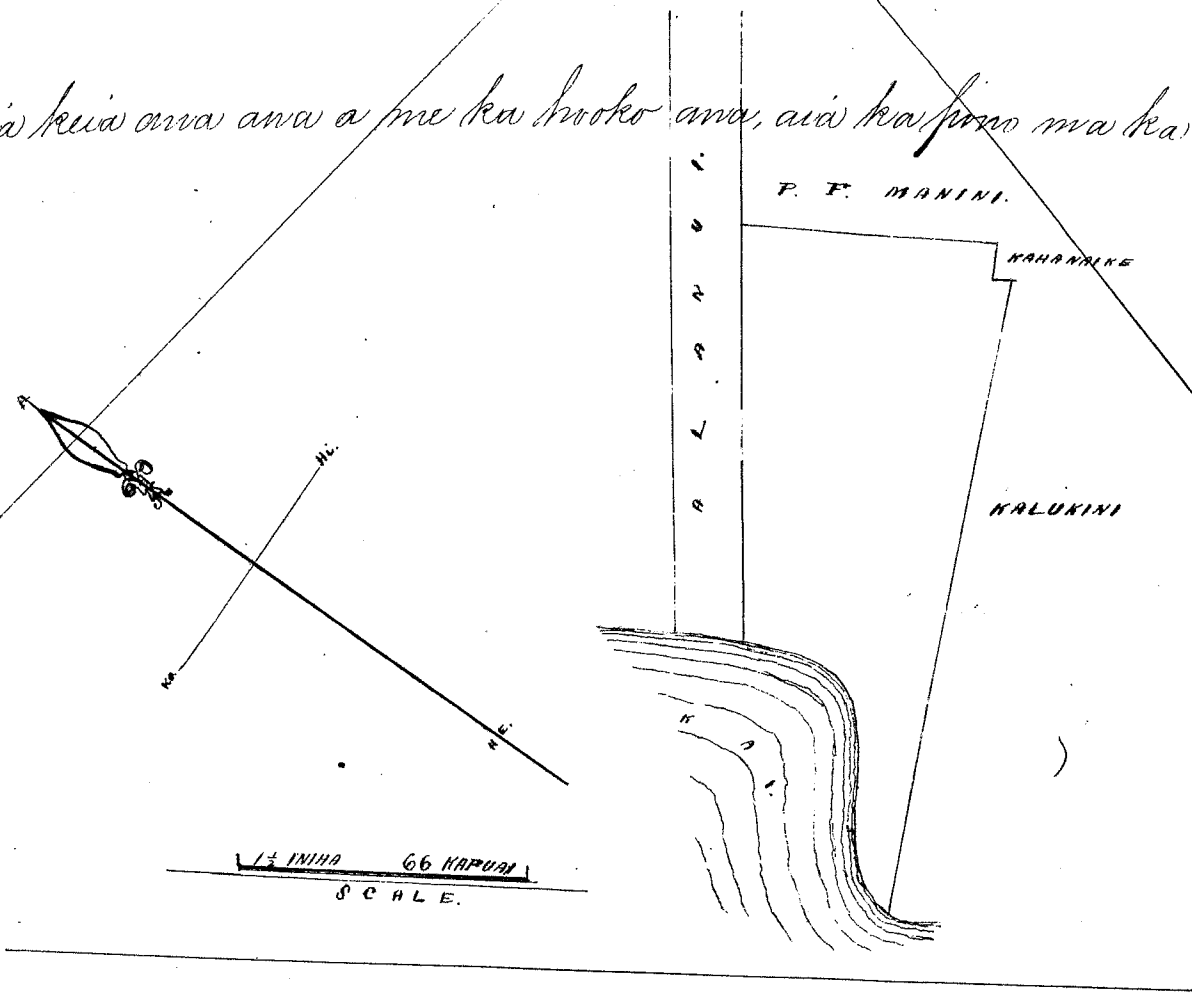

Helu 718 Kapahana

Kaumakapili

Ua kivi mai oia no kona wahi ma Honolulu ma kona maika (Mokupuni o Oahu, no ka mea, ua loaa ia ia keia wahi i ka manawa o Peholito me kona mau makua, Aka, ua kivi mai o Punalua i kona kuleana iloko oia wahi, a ua ae lilo no hoi laua e omahete a kaawale ko Punalua a me ko Kapahana; Nolaila, ua hele fpu kahi o na Lima Hoona me laua e omahete, a ua makelcia ma ka la 4 o October 1852, a ua apunoi ia omahete ana e Kapahana & Punalua, a ua moho keakea oleia a hiki i keia manawa.

Oia ka makou e hoko nei no Kapahana; he kuleana hoi kona malalo o ke Awa Alodis. Ana e ukui mai oia i ke ke Aupuni hapahaa; alaila, ua kupaia ia ia ka Palapala Lita Alodis. Pono na ia ia ke ukui no ka hooloholo a me ka hooloholo ana i ka olelo. Penei:—

- No ka rumi a me ke fua ana i ka olelo ma ka Mafipa. # Ten.
 - No ke kope ana i ka olelo koina
 - No ka palapala kii
 - No ka kama ana i ka la
 - No ke kope ana i na olelo a ma hoi ke
 - No ke ana ana i ka la 4 o October 1852. Ukuia ke Ana #3.
 - No ke kope ana
 - No ka hooloholo ana i ka olelo October 5, 1852.
- # 4.00

G. M. Robertson
 W. H. P. H.
 J. H. Smith
 L. S. M.
 S. K. K.
 Oia ma palena.

Anaia o A. K. K.

Pahale ma Honolulu, Oahu. E hoomaka ma ke kahi Hikina o keia Pahale e pili ana ma ka Pahale o Punalua a me ke Ala olelo e koma ana i ke la fua, a e holo i ka koma 54° 30' Nom. 94 1/2 Kapwai ma ka Pa o Punalua, a me kaunani o ko (M. Kekuamawa) a hiki i ka fua o Wm. Hughes, kahi. Alaila holo i ka Akau 28° Nom. 45 1/2 Kapwai ma ko Wm. Hughes, a hiki i ka fua o Kekuamanoa, - Alaila Akau 66° 15' Hik. 33 Kapwai a hiki i keahi ana kee koteke i ka Punawai; a i ka Akau 42° Hik. 37 1/2 Kapwai a hiki i kahi uakee o keia fua. Malaila mence Lima Koma 1 1/2 Kapwai, kahi; a i ka Akau 55° 30' Hik. 10 Kapwai i pili ana ia maan aao me ka fua o Kekuamanoa a hiki i ke Ala olelo e fuka ana iwaho. Alaila Koma 32° Hik. 14 1/2 Kapwai uakee, a i ka Akau 50° 30' Hik. 7 1/2 Kapwai, kahi, a i ka Koma 39° Hik. 34 1/2 Kapwai e pili ana ia maan aao ma ka kahi makai o keia Ala olelo i oleloia a hiki i keahi i hoomaka i Anaia Pahale 112 Anaia 24 1/2 Kapwai.

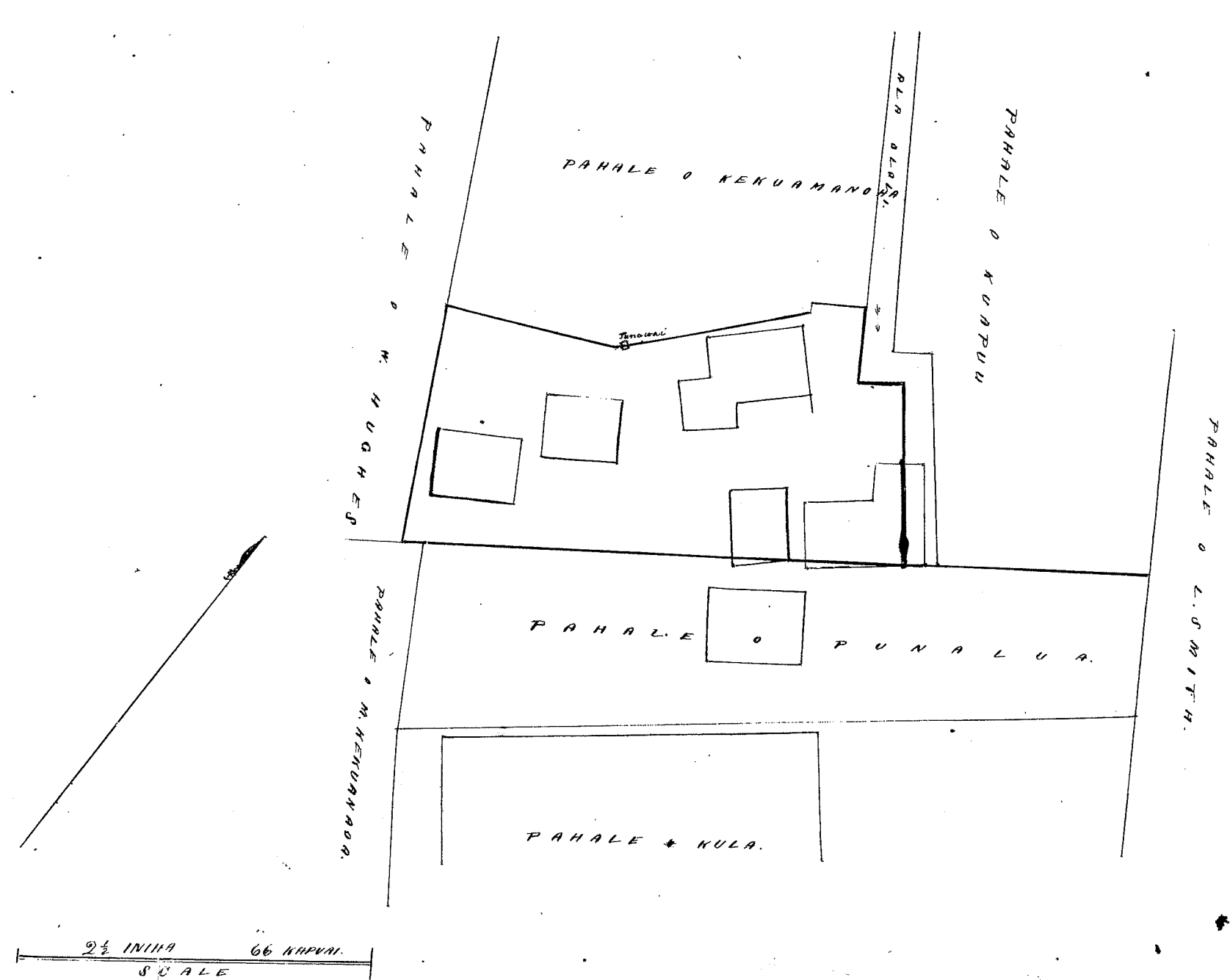

Ua koi mai oia no kona wahi ma Kawaihi ma Honolulu ma Kona ma ka Mokupuni o Oahu no ka ana, ua loa ia ia keia wahi no kona makuakane i ka manawa i make aku ai ia, a ua loa koi i kona makuakane no Hewahewa mamua loa, a ua noho keakea oia a hiki i keia manawa.

Oia ka makua e hoohe nei no Makanooene; ke kuleana hoi kona matala o ke Ano Aloha. Ima e ukui mai oia i ke ke Aupuni Napauna; aiaia, ua kupaia ia ia ka Palapala Ila Aloha.

Ima e iaia ke ukui no ka hoohe a me ka hoohe ana i ka olelo. Ima

Heleu

No ka umu a me ke pua ana i ka olelo ma ka Nupapa

No ke kope ana i ka olelo koina

No ka palapala kii

G. M. Robertson

No ka hana ana i ka la 23 o Iune 1848

W. Bee

No ka kope ana i ka olelo a me ke hiki 1/2 Ana

J. H. Smith

No ke ana ana i ka la 23 o Iulai 1852.

Ukui ke ana #3.

J. Kekaualana

No ke kope ana

Louise

No ka hoohe ana i ka olelo October 5, 1852.

Pauka # 6.00

Eia ma palena.

Anaia o A. Kalamia.

Oia me Kahuakala ma Kawaihi, Honolulu Oahu.

E hoomaka ma kukiki Kona makua o keia ana e fili ana me ke Paale a me Kawaihi o Kahuakala, a e holo Akau 42' Kom. 38 Pautu ma Kawaihi a hiki i Kumuulu ma George Kona (George Holmes) ma Kapauna, - Malaila aku Akau 49' Hik. 23 Pautu a me Akau 38' Kom. 30 Pautu a me Akau 58' Kom. 44 Pautu a me Akau 33' 30' Kom. 79 Pautu a me Akau 1/4 Degere Kom. 1.03 Kaul. ma ka ana o George Kona a hiki i ka pohaku x makua o ka pukaala e fili ana i Kapauna; - Malaila aku Akau 17' Hik. 57 Pautu a me Akau 25' Hik. 73 Pautu a me Akau 75' Hik. 68 Pautu ma Kapauna a hiki i Kawaihi Mui. - Malaila aku Akau 58' 30' Hik. 1.07 Kaul. a me Kona 56' Hik. 22 Pautu a me Akau 59' Hik. 73 Pautu ma Kawaihi Mui a hiki i ke Honolulu; - Malaila aku Kona 29' 15' Hik. 2.39 Kaul. ma ka ana o ke Honolulu a hiki i ke Paale; - Malaila aku Kona 62' Kom. 2, 40 Kaul. a me Kona 39' Kom. 3 1/4 Kaul. a me Kona 25' Hik. 54 Pautu a me Kona 54' Kom. 72 Pautu ma ke Paale a hiki i ka hui i hoomaka i.

Ma ia Ana

1 1/10 Eka.

Note. Approved by the Lema of the Honolulu, Kahuakala October 6, 1852.

G. M. R.

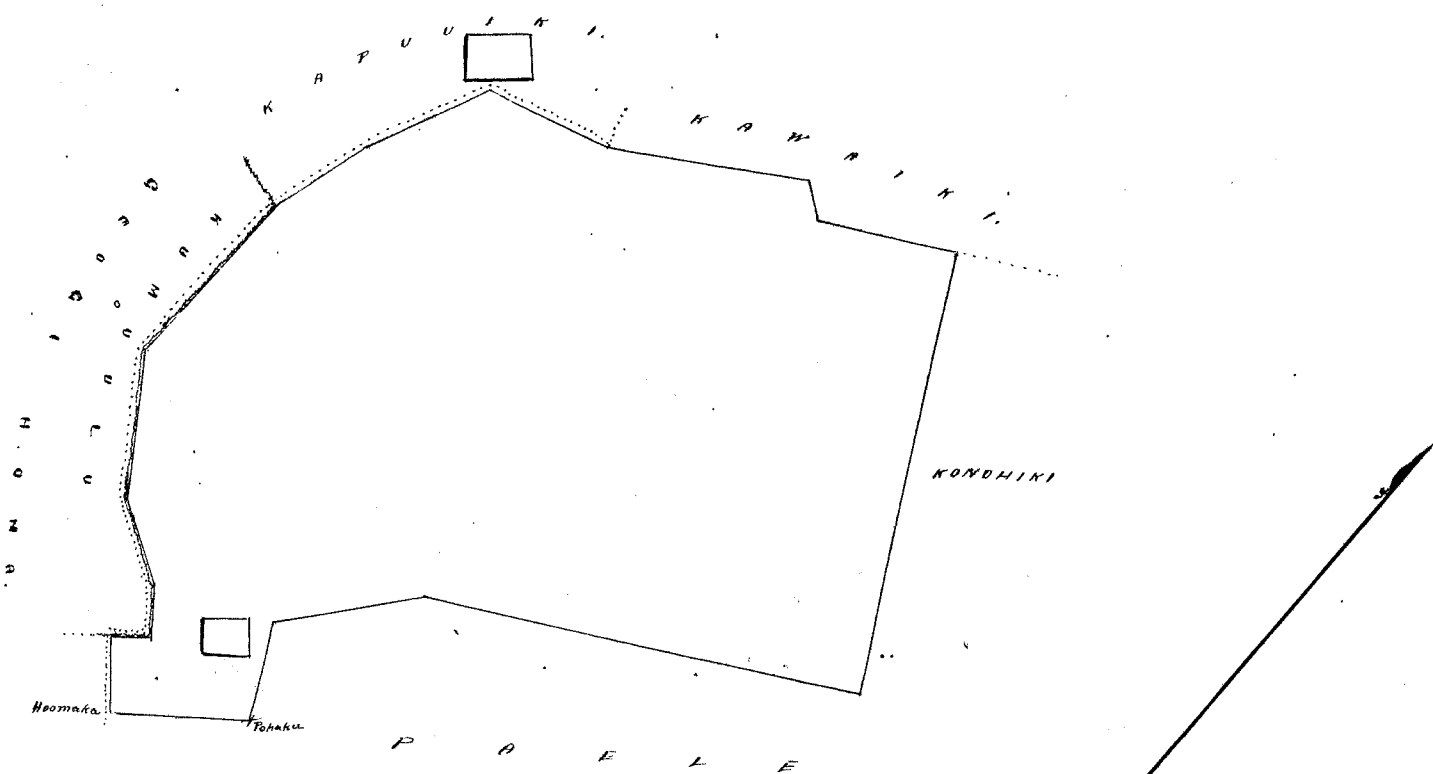

INIA KAUHANA SCALE

Helu 730 Punahoa

Ua koi mai oia no kona wahi ma Honolulu ma kona mau ka (Mokupuni) Oahu; no ka mea, ua laka ia ia keia wahi manawa i ka manawa no o Liholihu, a ua noho no oia mabaila a hiki i keia manawa, Aka, ua hoo-komo mai no o Kapuhana i kona kuleana ma kaawahi o keia pa i mahelaia, a ua a-liki no hoi laua, me e mahela a kaawale ko Kapuhana a me Punahoa. Aolaila ua holo fua kahi o ma Punahoa, me laua e mahela, a ua mahela ia ma ka la 4 o October 1852, a ua aponoia ia mahela ana e Punahoa a me Kapuhana, a ua noho keakea ~~hoo~~ oleia a hiki i keia manawa.

Oia ka makou e hoo-komo nei no Punahoa; he kuleana hoi kona, molalo o ke Aloha. Ana e uku mai oia i ke kei Aupuni kapuhana; aolaila, ua kupo no ia ia ka Palapala Paa Aloha.

Puni ma ia ia ke uku no ka hoo-kolo-kolo a me ka hoo-kolo ana i ka olelo, Puni, -

- No ka rumi a me ke fua ana i ka olelo ma ka Aupuni
- No ke kope ana i ka olelo koma
- No ka palapala kii
- W. L. Lee
- G. M. Robertson No ka hana ana i ka la 16 o Feberuari 1848.
- No ke kope ana i ma olelo a ma hoike
- J. Kekulani No ke ana ana i ka la 4 o October 1852. Ukuia \$3.-
- No ke kope ana
- Loane Si
- J. H. Smith No ka hoo-kolo ana i ka olelo October 5, 1852.

\$ 4.00

Oia ma fua ana. Anaia i S. Kalama

Pahale ma Honolulu, Oahu. E hoomaka ma ke kiki Aka maikai o keia Pahale e pili ana me ke kiki Aka o ka Pahale. M. Kekumana, a e holo i ka Hema 30° Hike. 55 Kapuwa maawaho o keia pa e pili ana me ka Pahale o M. Kekumana a hiki i ke kiki Aka maikai o ka Pahale Kula o L. Smith; - Aolaila holo i ka Aka 51 Hike. 140 Kapuwa ma ka Pahale Kula a hiki i keia pa o L. Smith; - Aolaila holo i ka Aka 33° Hema. 26 Kapuwa ma ka Pahale o L. Smith a hiki i keia pa o Kapuhana. Aolaila holo i ka Hema 56° 30' Hema. 140 1/2 Kapuwa ma ka Kapuhana a hiki i ke kiki Hema maikai o ia pa, pili ana me ke Ala Ololi i kukuhihikiia e G. M. Robertson ma keia mau pa; - Aolaila holo i ka Hema 54° 30' Hema. 96 1/2 Kapuwa ana ke Ala Ololi a me ka pa o Kapuhana a hiki i kahi i hoomaka i, a puni keia aia.

Makou i keia Pahale 126 1/2 Anana.

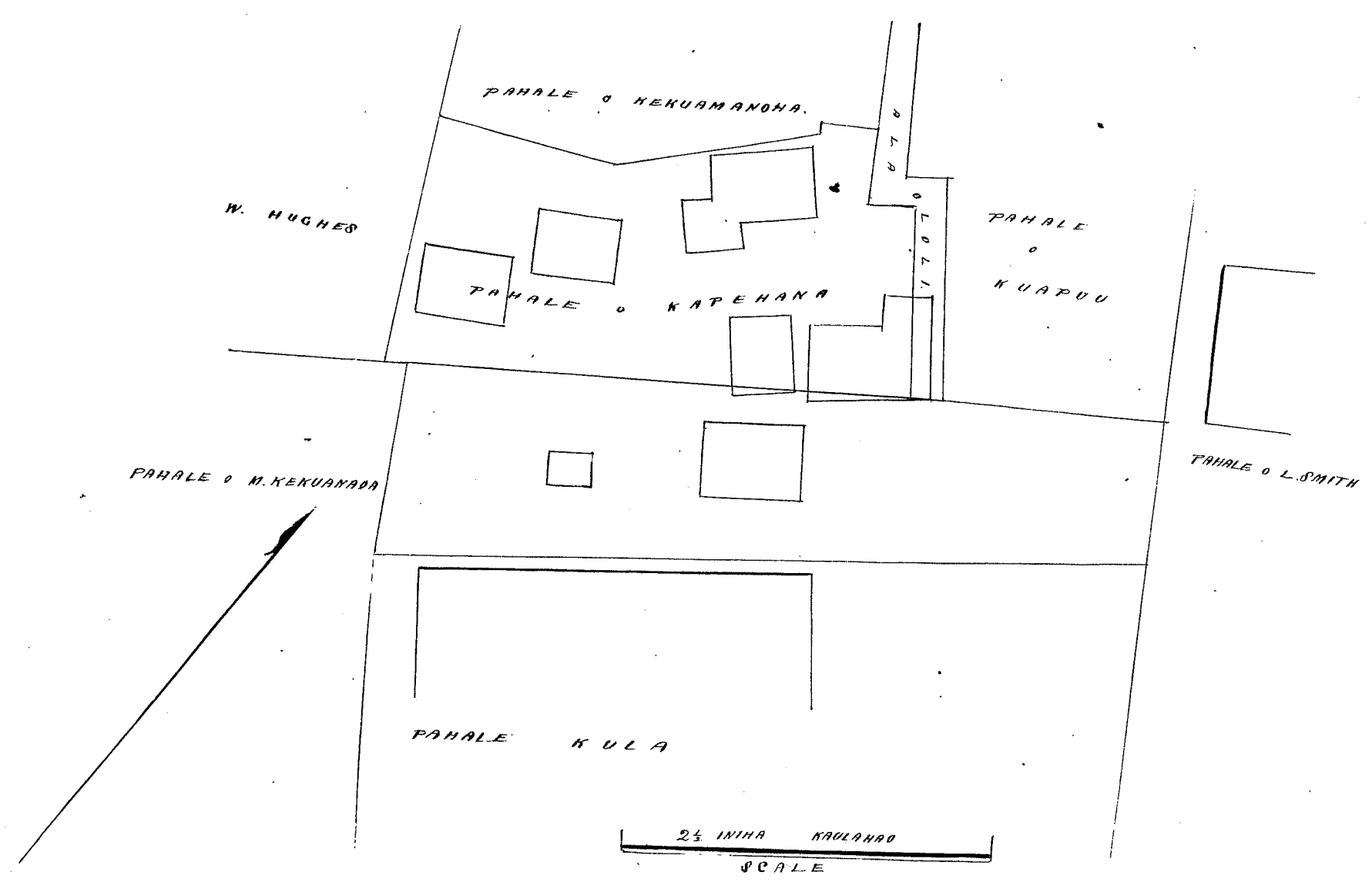

(Nana Avao 90, Oia ka pololei)

Ua kei mai oia no kona^{mau} wahi ma Nini ma Honolulu ma Kona ma ka Mokupuni, Oahu; no ~~ka~~ ona, eadi oia ia keia mau wahi no Hawaii ma kona makaukane i ka makahiki 1838, a ua loa hoi i kona makaukane i ka manawa o Kūnehanohā, a ua noho mau no Hawaii malaila a hiki i kona make ana, hoi i keia wahi ia Haikauai kana keiki, a ua noho keakea oia oia a hiki i kona make ana iho nei i ka M.H. 185 a hoi i kona mau wahi ia

Oia ka make ana iho nei no Haikauai; he Kuleana hoi kona malalo o ke Ulu Alodio. Ana e iho mai oia i ke ke Aupuni hapaha; alaila, ua hupuni ia ia ka Palapala Ulu Alodio. Pui mai ia ia ke iho no ka hoohelelele a me ka hoohelelele ana i ka olelo. Pui, -

- W. L. Lee* No ka sumi a me ke pui ana i ka olelo ma ka Aupuni.
- G. M. Robertson* No ke kope ana i ka olelo keia.
- J. H. Smith* No ka palapala hoi.
- A. Kakaulakao* No ka hana ana i ka la 8 o Februari 1850.
- No ke kope ana i na olelo a nashoike 1 Avao.
- No ke ana ana i ka la 6 o Awgate 1852. Ukaia ke (ma) 1/12.
- No ke kope ana.
- No ka hoohelelele ana i ka olelo October 8, 1852.

Oia na palena. *Anaia e S. Kulanua* Pauloa \$ 5.00

Na Kuleana o Haikauai ma Nini, Honolulu, Oahu.
Apana 1. 3 Loi. E hoomaka ma ke kahi Komohana o keia, a e holo Akau 23° Hiki. 192 Panku, a Akau 53° Hiki. 54 Panku, a Akau 11° Hiki. 97 Panku me ka aina o ke Honohiki ia Hoew a hiki i ka palena o Niupaipei no Adamu Kaiwi, - Alaila Akau 81 1/4 Hiki. 25 Panku me Adamu, a Hema 48° Hiki. 37 Panku, a Hema 40 1/2 Hiki. 52 Panku, a Hema 35° Hiki. 195 Panku, a Hema 62 1/2 Hiki. 33 Panku, hiki Hema, a Akau 36° Hiki. 136 Panku me ka aina o ke Honohiki a hiki i kahi i hoomaka i. 3/100 o ka Eka.

Apana 2. Kulanua hoi & Kula mahi. E hoomaka ma ke kahi Akau ma ka o keia, a e holo Hema 40° Hiki. 3, 68 Haul. hiki, a Hema 49° Hiki. 1 Haul. hiki a Akau 45 1/4 Hiki. 3, 47 Haul. hiki, a Akau 40° Hiki. 136 Panku a pui ana i ke Honohiki a hiki i kahi i hoomaka i. 43/100 o ka Eka.
Apana 3. 6 Loi. E hoomaka ma ke kahi Hikiina o keia e holo ana Hema 35° Hiki. 3, 44 Haul. ma ka aina o James Robinson, - Alaila Akau 40° Hiki. 135 Haul. a Akau 18° Hiki. 58 Panku kekei a neenee Lima Hema 14 Panku, hiki a Akau 3 1/2 Hiki. 64 Panku, a Akau 27° Hiki. 1, 84 Haul. a Hema 58 1/2 Hiki. 2, 27 Haul. ua pui ana i ke Honohiki a hiki i kahi i hoomaka i. 1/100 o ka Eka

Apana 4. Nana Loi & Kula mahi. E hoomaka ma ke kahi Akau ma ke o keia ma ka aina pohaku o ka Loi, a e holo ana ke Ala lili me ka aina o ke Honohiki, Akau 63° Hiki. 36 Panku, a Hema 86° Hiki. 64 Panku, a Akau 36 1/2 Hiki. 142 Panku a hiki i ka pohaku ma ke Ala lili me ka aina o James Robinson, - Alaila Hema 59 1/2 Hiki. 45 Panku, hiki, a neenee Lima Akau 20 Panku, make, a Hema 54° Hiki. 36 Panku pui ana me ke James Robinson a hiki i ka kahi ka pui, - Alaila Hema 30° Hiki. 3, 30 Haul. iho i ka hiki i ka kahi Akau o ka mana Akau o na Kahawai Eua, - Alaila holo pololei ma ka kahi ma ka o ka mana Akau a hiki i kahi i hoomaka i. 34/100 o ka Eka.

Apana 5. Loko ma Alalakai lele o Nini. E hoomaka ma ke kahi Komohana ma ke o keia, a e holo Hema 59° Hiki. 96 Panku a Akau 77° Hiki. 116 Panku me Honohiki a hiki i ka palena ma ka kahi auwai make, - Alaila Akau 1 1/2 Hiki. 148 Panku, hiki, a Akau 88 1/2 Hiki. 205 Haul. pui ana me Honohiki ia mau avao a hiki i ka kahi auwai, - Alaila Hema Hoohelelele Degere Hikiina 180 Panku ma ka auwai a hiki i kahi i hoomaka i. 35 1/2/100 o ka Eka.

Apana 6. Pahale 3 Loi ma Alalakai lele o Nini. E hoomaka ma ke kahi Hikiina ma ke o keia, ma ka kahi ma ke o keia Ala olelo o Hanuwa, a e holo Akau 9° Hiki. Panku, a Akau 2° Hiki. 120 Panku a Akau 5° Hiki. 2 Haul. a Akau 9° Hiki. 50 Panku ma ka kahi ma ke o keia Ala olelo a hiki i ke kahi Hikiina ma ke o keia, - Alaila Akau 82° Hiki. 52 Panku, a Hema 77 1/2 Hiki. 45 Panku, hiki, a Hema 2° Hiki. 3, 42 Haul. a Hema 4° Hiki. 128 Panku, a Akau 83 1/2 Hiki. 116 Panku pui ana me Honohiki ia mau avao a hiki i kahi i hoomaka i. 5/10 o ka Eka.

Mua ia mau Apana 6 — 2 7/8 Eka

Ua hoohelelele hoi keia Apana 2, a kope hoi ma ka la 90 o keia Eka. a oia kope ana ka pololei loa. E iho keia.

J. E. Nihilili
Kakaulakao

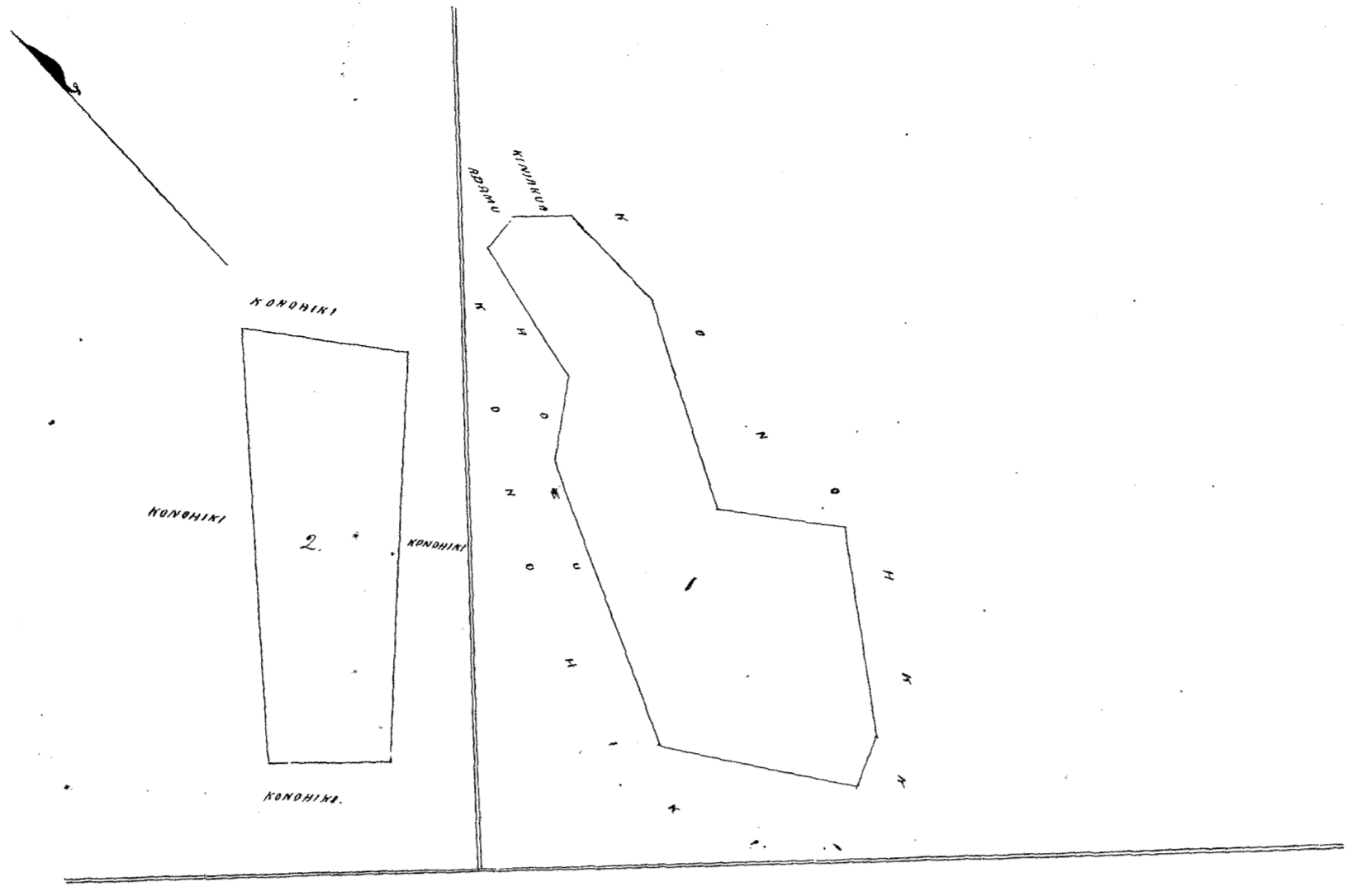

Ololoakaka

Ua hoohuaia ka Apana 2
 ma keia kope ana, a ona Apana
 e ae ma pono no. Ua kope kuuia
 ma ka Apana 96 o keia Butte.
 oia ka hoohuaia loa.
 October 27, 1852. A. L. Naititi
 Kakaulele o na L. H. K. U.

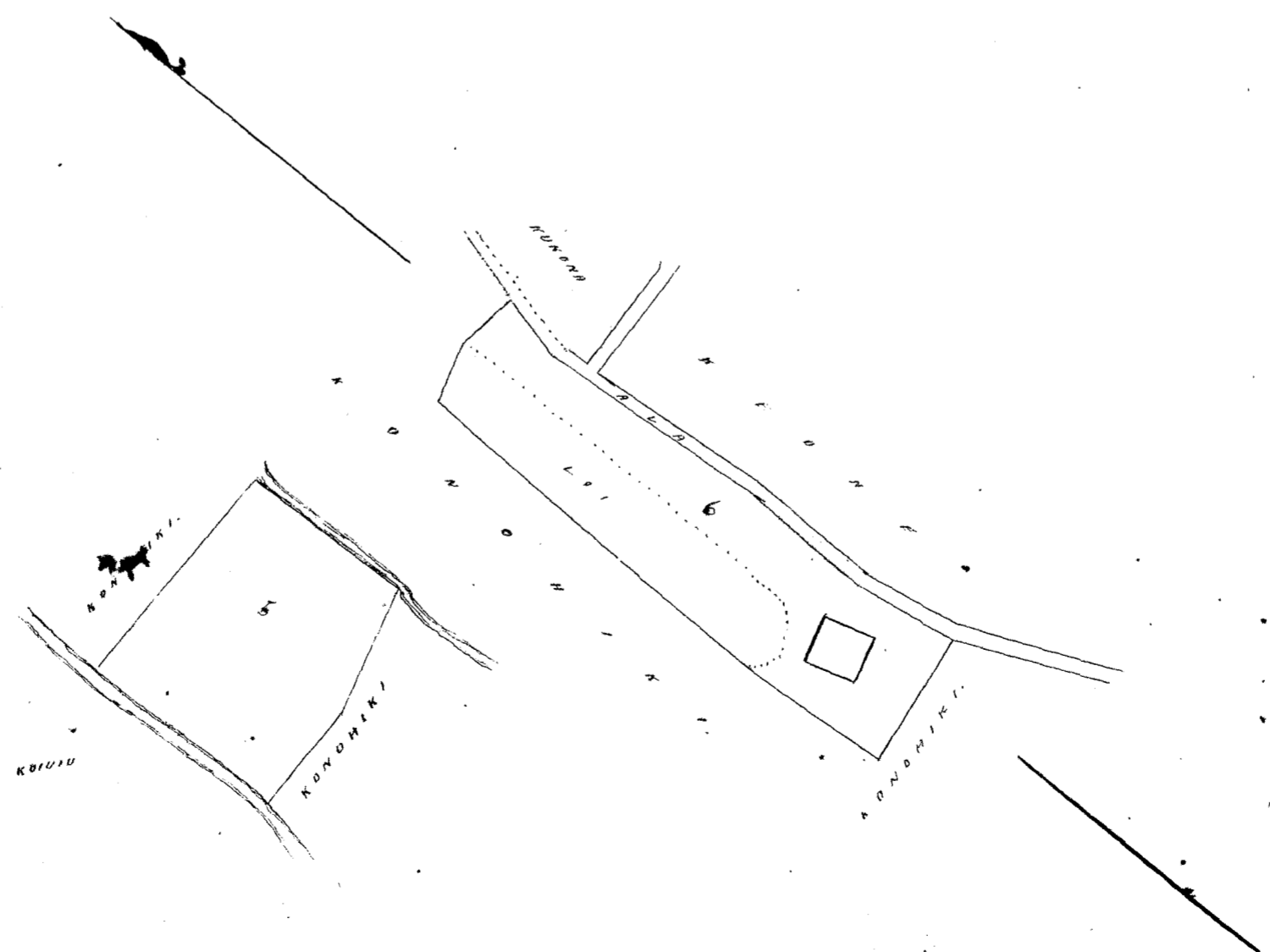

Ua koi mai oia no kona mau wahi ma Kapouhi & Kalia ma Honolulu ma Aona ma ka Mokupuni o Oahu; no ka mea, ua hooia ia keia wahi ma Kapouhi no Peki mai i ka M.H. 1827, a nona pono no hoi kahi ma Kalia, a ua oho kokea oia a hiki i keia manawa.

Oia ka makou e hooke nei no Pehu; he Kahuana hoi kona malalo o ke Ani Alo-dia. Ima e ukou mai oia i ke ke Oupuni hapaaha; alaila, ua kupo ia ia ka Palapala Pila Alo-dia.

Iua nani ia i ke ukou no ka hookelele a me ka hookelele ana i ka olelo. Ima e

§ Hen.

No ka runni a me ke paiana, i ka olelo ma kea Kupuha

No ke kope ana i ka olelo koina.

No ke palapala kii

No ka hana ana i ka la 2 o Feb. 1848 & 16 Nov. & 26 o Dec. 1850.

No ke kope ana i na olelo a me hoi ke 5 Aho

No ke ana ana i ka la 21 o December 1850 & 17 o September 1852.

No ke kope ana

No ka hookelele ana i ka olelo October 8, 1852.

§ 15.00

G. M. Robertson

Pehu

J. K. Kaulahao

J. H. Smith

Oia ma palena.

Maia e. C. J. Lyons & S. P. Kapaama.

Ahana 1. Pahale ma Kapouhi ma Honolulu, Oahu.

E hoomaka ana ma ke kahu Aona, makai, a u holo Aka 46 1/2 Hikiina 3.37 kaula, a me Aka 36° Komoana 2.20 kaula ma ka Alanui Mahiaai; Alaila Aka 32° Komoana 1 kaula, a me Aka 77° Komoana 1.73 kaula ma ka aia o ka Moa. Alaila Aka 25 1/2 Hikiina 1.25 kaula, a me Aka 49 1/2 Komoana 2.90 kaula ma ka aia o Piki. Alaila Aka 60° Hikiina 2.78 kaula ma ka pahale o Kauliokama, a me Aka 50° Hikiina 42 paku ma ka Alanui Mahiaai a hiki ma ka aia o Kauliokama.

Ia maloko o keia Pahale

1 3/4 Eka.

C. J. Lyons. Sur.

21 December 1850

Ahana 2. Pahale ma Kalia ma Honolulu, Oahu.

E hoomaka ma ke kahu Aka o keia Pahale, e fili ana ma ke Alanui Mahiaai a me ke Kauliokama no Kauliokama. Ua holo aku i ka Aka 27° Komo 2 kaula 47 paku a hiki i ka aia o keia aia, a me Aka 19° Komo 1 kaula 29 paku e fili ana ia mau aia ma ka aia o keia Alanui Mahiaai a hiki i ke kahu Komoana o keia Pahale. Alaila aku i ka Aka 64° Hiki 50 paku a me Aka 82° 30' Hiki 1 kaula 88 paku e fili ana ma ke Akaawa. Alaila aku i ka Aka 51° Hiki 76 paku a me Aka 20° Hiki 1 kaula 40 paku ma ke Aka. Alaila aku i ka Aka 50° 30' Komo 2 kaula 64 paku ma ke Kauliokama a hiki i ka aia o Kauliokama.

Ia ia Pahale

350 Aiana

S. P. Kapaama

17 Sepalema 1852.

Ma Aona Aia

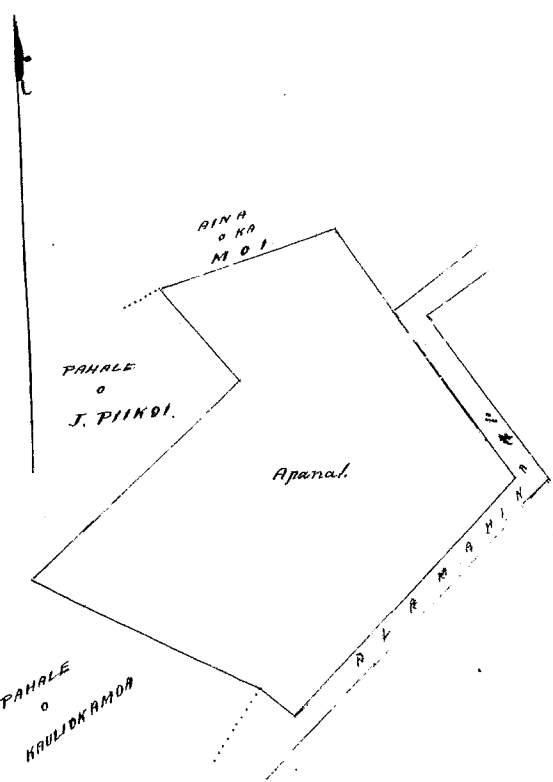

2 chains to an Inch.

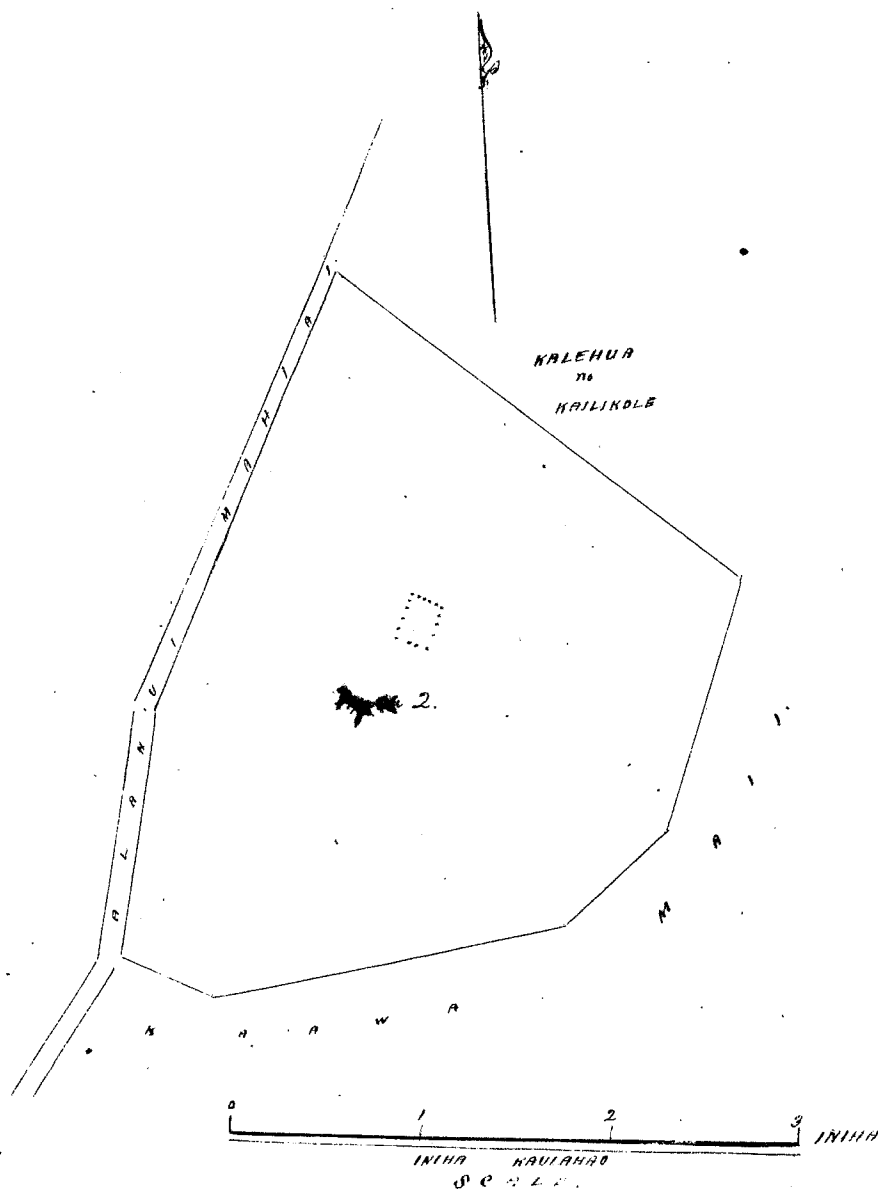

Kelu 2833 Mahoe

Ua koi mai oia mo kona mau wahi ma Kamakela a me Koiuina ma Honolulu aia ma ka
 Nukunui o Oahu, no ka mea, ua hoo ia ia keia mau wahi ma Hanawa mai ka Pahale i ka manawa
 o Kaomi mamua aku o ka makahiki 1835, a me Kaiaiwawawa mai keia ka Apana aia ma Hale i ka manawa
 i ka make ana o Liliha, a ua hoo keakea oleia a hiki i keia manawa.

Oia ka matakou e hooke ana mo Koiuina, ke Kuleana hoi, hono a, malalo o ke Ano-Atodiu. Ina e
 iku mai oia i ke ke Aupuni hapatua, aiaia, ua kupaia ia ia ka Palapala Pila Atodiu.

Pene masia ia ke iku mo ka hooke-olelo a me ka hooke-olelo ana i ka olelo. Pene:

- No ka omi a me kei pui ana i ka olelo ma ka Nupua.
- No ke kope ana i ka olelo Koina
- G. M. Robertson No ka palapala kii
- J. H. Smith No ka hana ana i ka la 24 o Iulai 1851.
- W. K. He No ke kope ana i ma olelo a ma hoi ke 1/2 Awa
- J. Kekaulaha No ke ana ana i ka la
- No ke kope ana
- No ka hooke-olelo ana i ka olelo October 8, 1852.

\$ Hon.

Eia ma palena. Anai a A. F. Turner

Pawlo \$ 6.00

Apana 1. Pahale ma Kamakela ma Honolulu, Oahu.
 E hoomaka ana ma ke kiki Koina, a e hoo

Akau 48° Komohana	57	fautu e pili ana i ke	Aupuni
Akau 45° Kikina	97	"	Hale
Koina 45° Kikina	46	"	Aupuni
Koina 38 1/2° Komohana	95	"	Hukona
a hiki i ke kiki mua			58 Anana

Apana 2. 5 Poi ma Koiuina ma Honolulu, Oahu.

E hoomaka ana ma ke kiki Koina, a e hoo ana

Akau 40° Kikina	160	fautu e pili ana i ke	Alani Aupuni
Akau 44° Komohana	80	"	ko S. Kaupuni
Koina 86° Komohana	14	"	"
Akau 36 1/2° Komohana	88	"	"
Koina 59° Komohana	135	"	ka Aupuni
Koina 27° Kikina	54	"	Konshiki
Koina 12° Komohana	30	"	"
Koina 49° Kikina	155	"	"
i ke kiki mua			0. 323 o ka Eka.

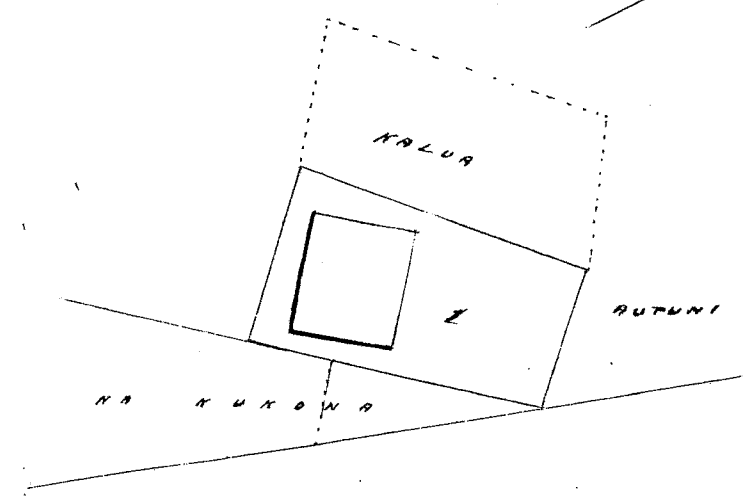
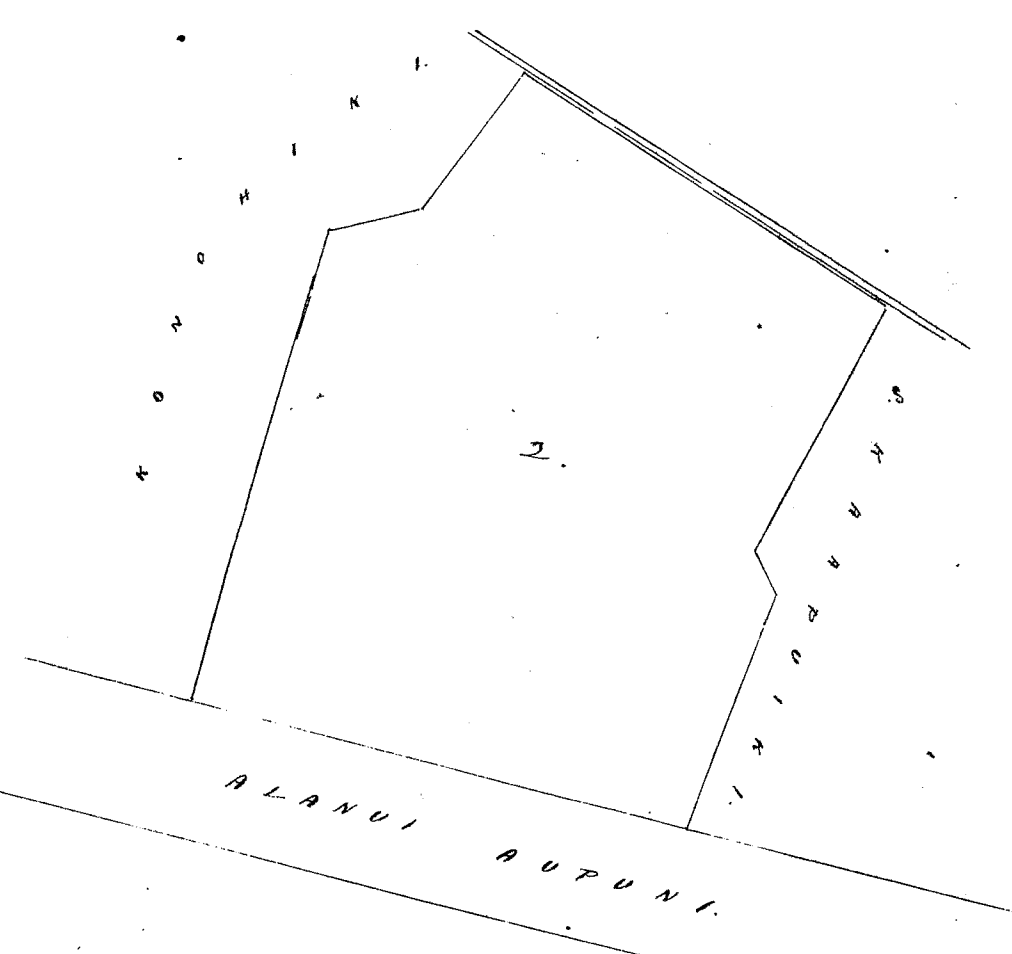

Ua koi mai oia no kona, wahi ma Auwailimu a me Hewalo ma Honolulu, ma ka Mokupuni o Oahu; no ka mea, ua loa iaia keia mau wahi no Ninawa mai ka M. H. 1839, a ua mahe keakea oia a hiki i keia mau wahi.

Oia ka makou e hooke nei no Taia; ka kuleana hoi kona maabala o ke Amo Alo-dio. Ima e ukui mai oia i ke ke Kupuni hapaha; Alaila, ua kupone iaia ka Palapala Pila, Alo-dio. Iono nae iaia ke ukui me ka hooke holo holo a me ka hooke holo ana i ka olelo. Penei; -

Hen.

No ka ruuni a me ke faai ana i ka olelo, ma ka Mapepa

No ke kufe ana i ka olelo keina

No ka palapala hii

No ka hana ana i ka olelo 26 o Detemaba 1850

No ke kufe ana i ka olelo a wahi i ke 1/2 Awa-

No ke ana ana i ka olelo 6 o October 1852.

No ke kufe ana

No ka hooke holo ana i ka olelo October 10, 1852.

Pau loa # 7.00

G. M. Robertson
J. H. Smith
W. Lee
J. Kekaulaha

Eia na palena.

Anaia e S. Kalama

Aina ma Auwailimu a me Hewalo ma Honolulu, Kona, Oahu.

Ahana 1. Kahua Pahala ma Auwailimu. E hoomaka ma ka lilihi Kona o ke Alanui hono no Paua. Ua holo i ka Kona 81° 30' Hik. 1 1/2 ka hiki, a me Kona 6° Hik. 8800 Kaul. e pili ana me ka aina Kula no ke Alopalapala a hiki i ke Ala Ololi ka hiki me ka Hale Kula, - Alaila Kona 83° Hon. 3 2/3 ka hiki, ma ka lilihi Aka o ia Ala Ololi a hiki i ka pohaku x ma ke hiki o ka faa o Heawepoole, - Alaila Aka 6° Hon. 1 2/3 ka hiki, ma ke Heawepoole a hiki i ka lilihi Kona o ke Alanui hono, - Alaila a me ka lilihi o ia Alanui a hiki i ka hiki i hoomaka'i. Kona Ali 44/100 Eka.

Ahana 2. 10 Loi ma Kapuni i Hewalo. E hoomaka ma ke lilihi Kona o keia aina ma ka pohaku, hiki Hikina o ka Aina o Kona, a e holo i ka Aka 55° Hon. 1 2/3 ka hiki, a me ke kupone Kona Kona 14 Pautu hiki, a me Aka 56° Hon. 79 Pautu ma ke Kona a hiki i ka auwai, - Alaila Aka 56 1/2 Hik. 1 2/3 ka hiki, ma ka lilihi Kona o ke auwai iwaena o keia a me ke Heawepoole a me J. Booth, - Alaila Aka 30° Hon. 2 1/3 ka hiki, a me Aka 28° Hik. 32 Pautu, a me Aka 29° Hon. 75 Pautu ma ke auwai o J. Booth, a me Heawepoole a hiki i ke Kona hiki, - Alaila Aka 63° Hik. 1 2/3 ka hiki, a me Kona 76° Hik. 93 Pautu, a me Kona 33° Hik. 42 Pautu, a me Kona 29° Hon. 12 Pautu a me Kona 27° Hik. 1.67 Kaul. a me Kona 55° 15' Hon. 1 1/2 ka hiki, a me Kona 41° 15' Hik. 2 1/3 ka hiki, ma ke Kamahee Piki o me J. Booth a hiki i ka lilihi auwai, - Alaila Kona 22° Hon. 36 Pautu a me Kona 52° 30' Hon. 70 Pautu ma ka auwai a me ke Kamahee a hiki i ka hiki i hoomaka'i ke ana ana a pili keia aina. Kona Ali 52/100 Eka.

Ahana 3. 1 Loi ma Kapuni, Hewalo. E hoomaka ma ke lilihi Kona ma ka o keia Loi, ma ka palena hoopuapua o Iona Piki o me Maheke, a e holo i ka Aka 34° Hik. 73 Pautu ma ka auwai me ke Kamahee a hiki i ke Iona Piki, - Alaila Aka 46° Hon. 1 2/3 ka hiki, ma ke J. Piki a hiki i ka aina i oleloia no Kapuni, - Alaila Kona 55° Hon. 71 Pautu ma ka auwai a hiki i ka palena hoopuapua i oleloia no J. Piki, - Alaila Kona 45° Hik. 1 2/3 ka hiki, ma ke J. Piki a hiki i ka hiki i hoomaka'i. Kona Ali 12/100 Eka.

Emma i na Iii ma Kela Awa. 76

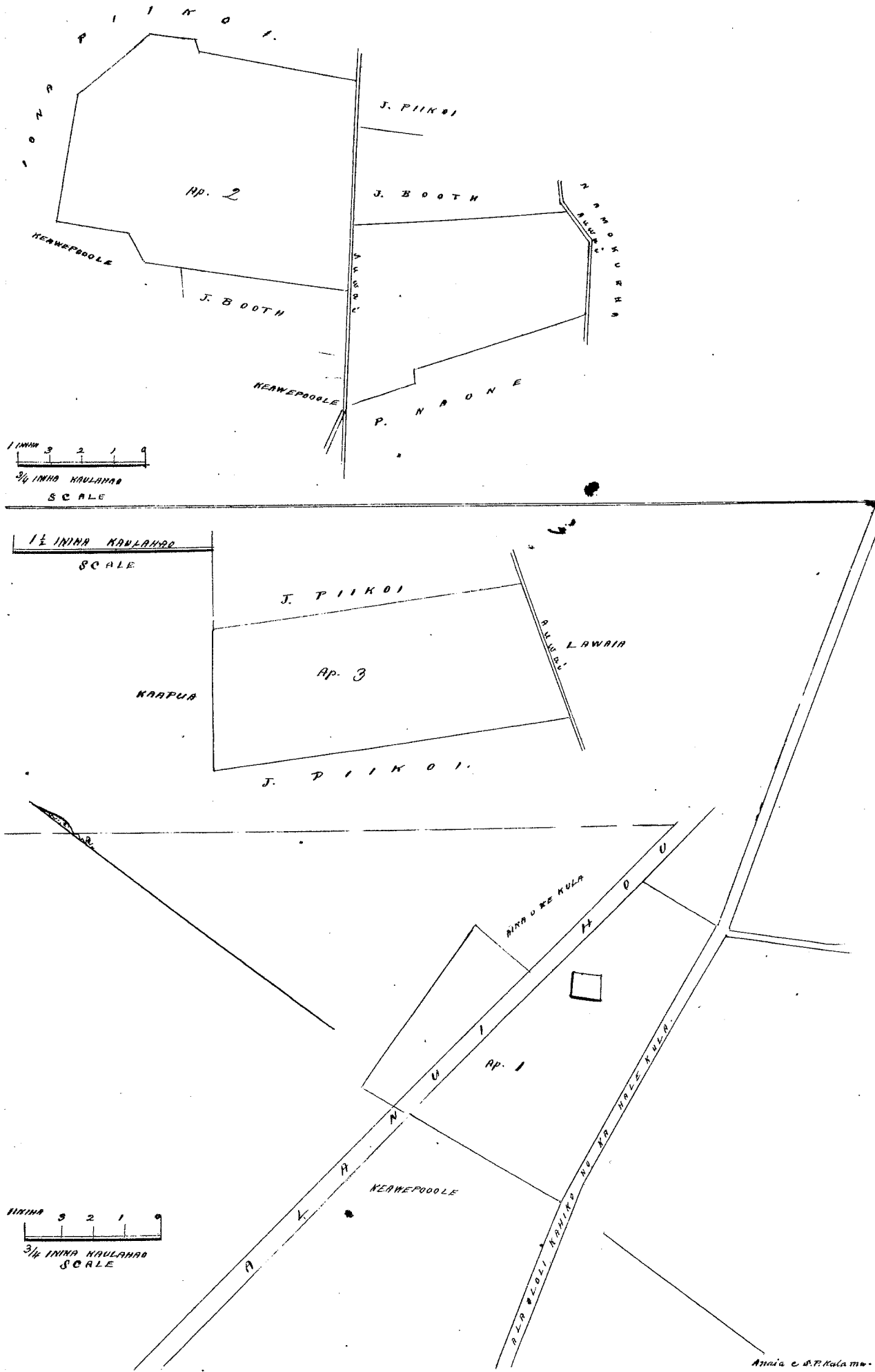

Kele 949 Lawaia

Ua koi mai oia no kona mau wahi ma Auwailimu a me Keialo ma Honolulu ma Kona ma ka Mokupuni o Oahu; no ka mea, ua hooia ia ia keia mau wahi no Kaunahāhā mai mamua aku o ka holo ana o Pōhi i ka M.H. 1829, a ua wahi keia oia a hiki i keia manawa.

Oia ka maikai e hooia nei no Lawaia; he kuleana hoi kona, malalo o ke Aunāhāhā. Aua e uku mai oia i ka ke Aupuni hupaka; aiaia, ua hooia ia ia ka Palapala Pila Alodial.

Pono nae ia ia ke uku no ka hoo-holo ana a me ka hoo-holo ana i ka olelo, Penei,

G. M. Robertson
 O. H. Smith
 W. Bee
 J. Kekaulaheo

No ka nui a me ke faia i ka olelo ma ka Aupuni.
 No ke kope ana i ka olelo Kona
 No ka palapala hoi
 No ka hooia ana i ka la 11 o Maraki 1851.
 No ke kope ana i ma olelo a ma hoi ke 1/2 Uao
 No ke ana ana i ka la 6 o Dekemaba 1851. Ukuia \$750.
 No ke kope ana
 No ka hoo-holo ana i ka olelo October 11, 1851

Oia na palena.

Anna C. P. Kalama.

Heleu 2142 Kawaakeiki

Ua kovi mai oia no kona mau wahi ma Kauluwela ma Honolulu i kona ma ka Moku-
fuuhi. Oahu; no ka mea, ua loa ia ia keia mau wahi no Kamaikahulipu mai i ka manawa e ola ana.
Kona mau mau ahu o ka makatuki 1839, a ua noho keakea oleia a hiki i keia manawa.

Oia ka makou e hooke nei no Kawaakeiki; ke kuleana hoi kona, malalo o ke Ann Alodis.
Ina e uku mai oia i ke ke Anupuni hapaha; alaila ua kupo ia ia ka Palapala Lila Alodis.
Pona naia ia ke uku no ka hookele-kole a me ka hookele ana i ka olelo. Penei;

G. M. Robertson
W. A. Pea
J. Hekaulaha
J. H. Smith

No ka umu a me ke pui mai i ka olelo ma ka Muepepa
No ke kope ana i ka olelo koma
No ka palapala hii
No ka hana mai i ka la 14 o Augato 1850.
No ka kope ana i na olelo a ma hiki
No ka ana ana i ka la 11 o October 1852.
No ke kope ana
No ka hookele ana i ka olelo October 13, 1852.

Kem.

Eia na palena.

Amia e S. P. Kalamua.

Paulo # 7.00

Apana 1. Pahale ma Kauluwela Honolulu, Oahu.

E hoomaka ma ke kahi Kema makai o keia Pahale, e fili ana me ka aina o Honolulu;
A e holo aku ma ka Ukaui 42° 15' Kom. 1 1/100 Kaulaha ma ka aina o ke Honolulu a hiki i ke kahi
Kikina ma ka o ka aina o Kalawemauu; - Alaila Ukaui 58° 45' Kom. 77 Pautu ma ka ana a
S. Diltua no Kalawemauu a hiki i ke Kuaaina Kahua Pahale; - Alaila Ukaui 42° 30' Kom. 1 53/100 Kaulaha
ma ke Kuaaina a hiki i ka pua o ke Honolulu; kahi; - Alaila Kema 47° 1/2 Kom. 2 82/100 Kaulaha, kahi,
a me Kema 49° Kom. 1 5/100 Kaulaha fili ana me ka aina o ke Honolulu a hiki i ka hiki i hoomaka i.
Maloko o ia Pahale 37 1/10 Anana.

Apana 2. 5 Loi.

E hoomaka ma ke kahi Kikina ma ka o keia aina, e fili ana me ka
aina Kuleana ole o Kaula, a me ka aina kuleana o Male, a e holo aku i ka Kema 33° 30' Kom. 1 23/100
Kaul. kahi; a me Ukaui 55° 3/4 Kom. 4 7/100 Kaul. anakua, a me Ukaui 24° Kom. 26 Pautu, ma ke, a
me Kema 70° Kom. 23 Pautu, anakua, a me Ukaui 55° Kom. 2 33/100 Kaul. anakua; a me Ukaui
42° 3/4 Kom. 94 Pautu e holo ana ia palena maluna iho o ka palena kupauna o ka aina o Male a
hiki i ka auwai liliu ma waena o Kauluwela a me Kikina on Kuaiaawaawa; - Alaila Ukaui 48°
Kom. 97 Pautu ma ka palena auwai me ka Kuaiaawaawa a hiki i ka pahu ma Kuaiaawa
o keia me ke Kaula; - Alaila Kema 58° Kom. 78 Pautu a hiki i ka pahu ma ka pahu; - Alaila
Kema 60° Kom. 2 63/100 Kaul. e makete kapakahi ana i Kuaiaawaawa a hiki i ka pahu ma ka hiki ana
hina o keia Kuaiaawa; - Alaila Kema 51° 30' Kom. 4 1/100 Kaul. ma Kuaiaawa o keia me Kaula kela mau
awa a hiki i ka hiki i hoomaka i ke ana ana, a pua keia aina.
Maloko o keia aina 1 Eka 12 1/10 Anana

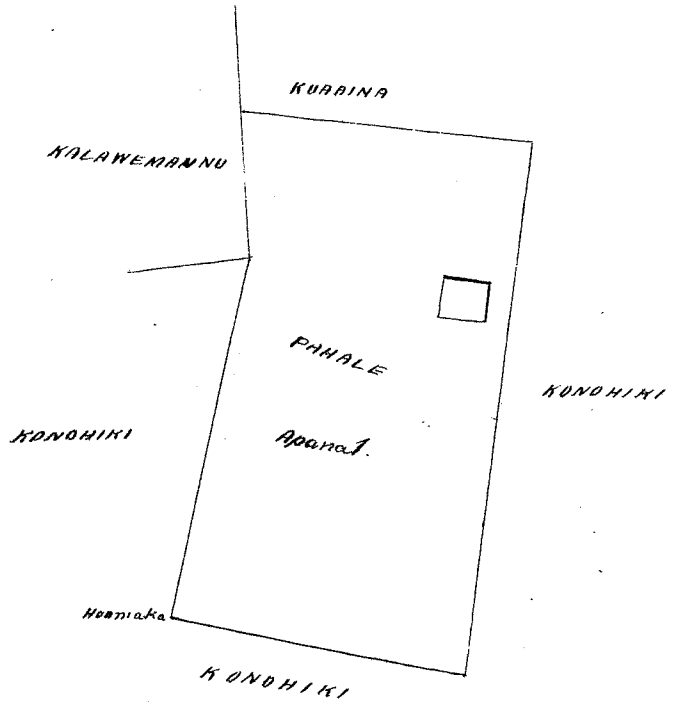
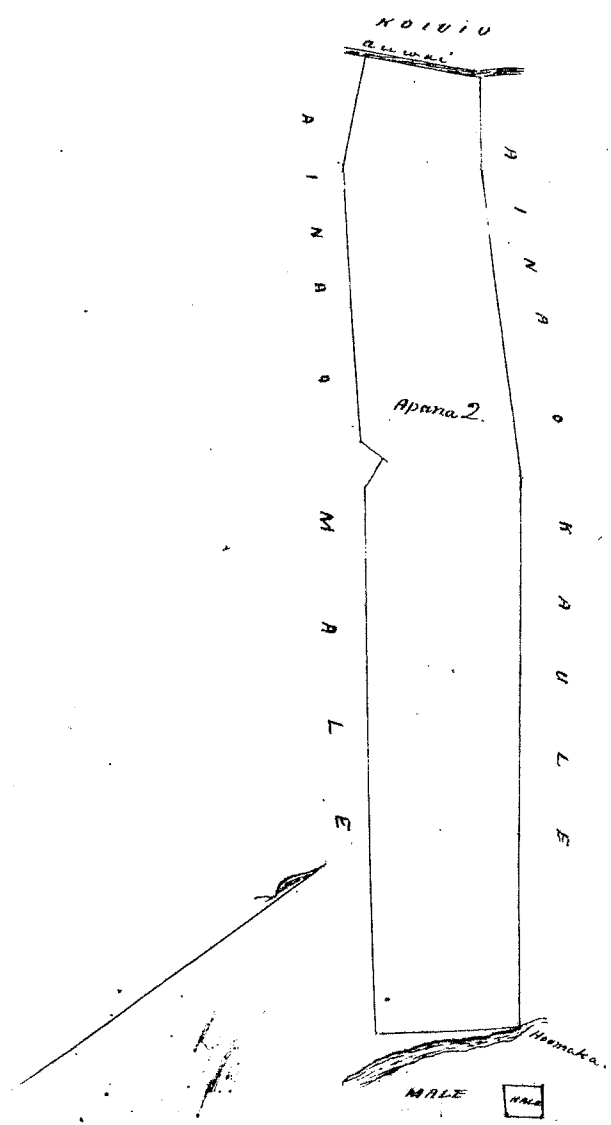

Ua kei mai oia ne kona wahi ma Kalawahine ma Honolulu i Hona ma ka Moku o Cahu,
no ka mea, ua loa ia ia keia wahi me Kaunahou i ka manawa e ola ana o Kahu, a ua nui kea
ka olea a hiki i keia manawa.

Oia ka makou i huko nei me Puiwa; he kuleana hiki kama anelalo o ke Anu Aloha. Ina e aho
mai oia i ke ke Aupuni hapa; alaila, ua kupaia ia ia ka Palapala o Aloha.

Pono na ia ia ke uku no ka hohokohole a me ka hohokohole ana i ka oleo. Pono, -

§ Hen.

No ka simi a me ke pui ana i ka oleo ma ka Aupuni.

No ke kipi ana i ka oleo keia.

No ka palapala keia.

G. M. Robertson
W. Lee.

No ka hana ana i ka la 30 o Aulani 1852.

No ke kipi ana i na oleo a me ke kipi keia.

J. Kekaulaao

No ke ana ana i ka la 6 o Oatohu 1852.

J. H. Smith

No ke kipi ana
No ka hohokohole ana i ka oleo. October 13, 1852.

§ 5.00

Eia na palena.

Aiaia o S. Kalama.

Aiaia ma Kalawahine ma Honolulu, Cahu.

5 Lei. E hoomaka ma ke kipi Hona, ma ka ike ike ma me ke Kolo o Levi Kaula, a
hoko i ka Aka 50° 30' Kik. 80 Puku, a me Hona 43° Kik. 58 Puku, a me Aka 62° 3/4 Kik. 47 Puku, a me
Aka 33° Kik. 28 Puku, a me Aka 21° Kik. 37 Puku, a me Aka 43° Kik. 17 1/2 Kaul. ma ka Kaunahou a
hiki i ke Kolo, - Malaila a ka Hona 38° Kik. 64 Puku, a me Aka 54° 30' Kik. 47 Puku, a me Hona
39° Kik. 34 Puku, a me Aka 61° Kik. 17 1/2 Kaul. ma ke Kolo, a me Hona 25° Kik. 13 Puku ma ka lei
Kaula o Kolo a hiki i ke Kolo, Malaila a ka Hona 60° 15' Kik. 14 1/2 Kaul. a me Hona 42° Kik. 18 1/2
Kaul. ma ka Lei Kolo o Kaula a hiki i ka hiki i hoomaka i ke ma ana a pui keia aiaia.

Malaila o ia Aupuni aiaia

he 34 1/2 Eka

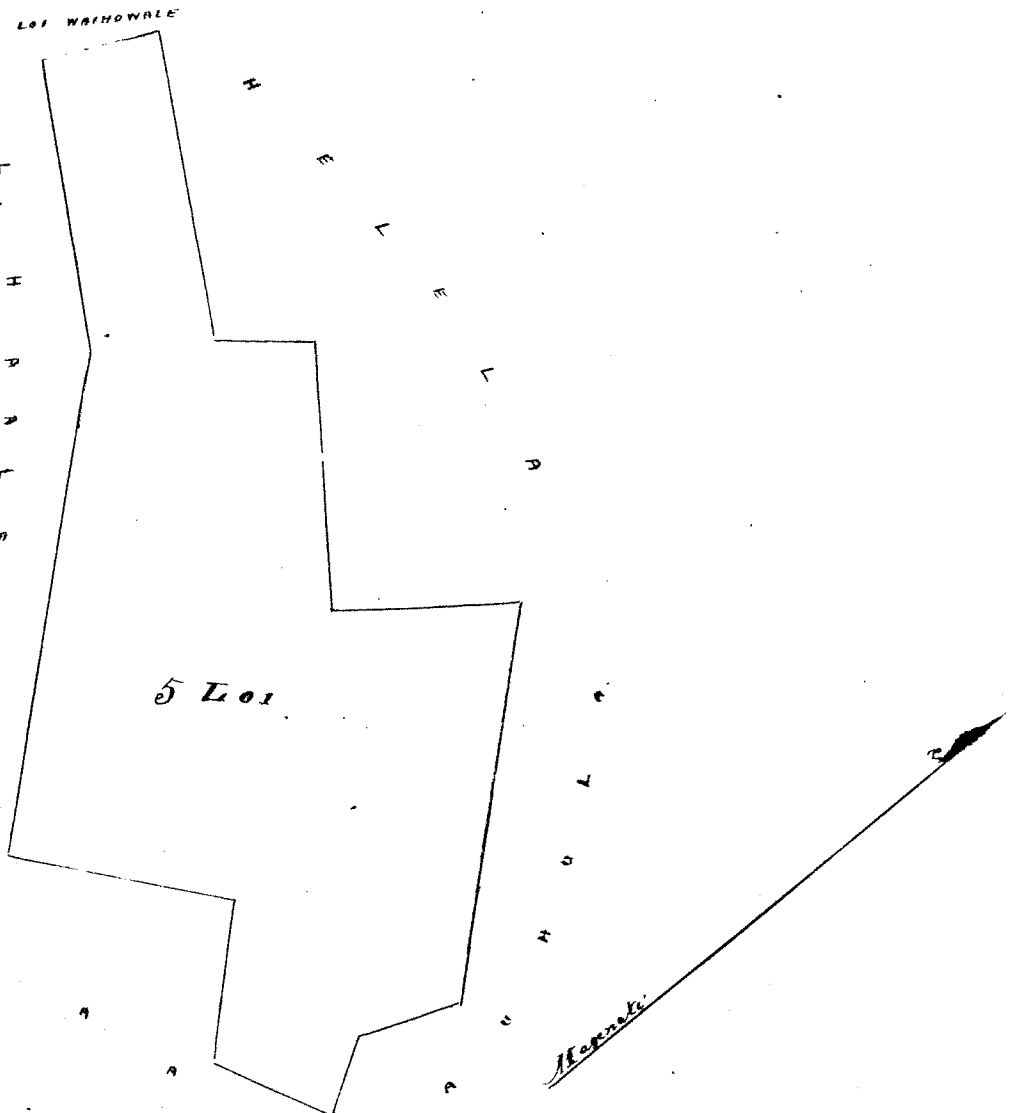

1/2 INCH KAWAHAO SCALE

Helu 3095B Puati

Ua koi mai oia no kona mau wahi ma Kahahuna ma Honolulu ma Kona ma ka Moku-
 puni o Oahu, no ka mea, ua loaa ia ia keia mau wahi ~~no~~ no Kapu mai ke Honolulu i ka manawa no o
 la ana o Liliha, a ua noho keakea oleia u hiki i keia manawa.

Oia ka maku e hoko nei no Puati; he huleana sui kama, malalo o ka Ano Alodio. Ina
 e uku mai oia i ke ke aupuni hapaha; alaila, ua kupuni ia ia ka Palapala Pila Alodio:
 Pene nae ia ia ke uku no ka hurokolokolo a mu ka hurohoro ana i ka olelo. Penei: -

- No ka runi a me, ke fari ana i ka olelo ma ka Mupupa
- No ke kope am i ka olelo koina
- No ka palapala kii
- No ka kama ana i ka la 27 o Ipelemaha 1852.
- No ke kope ana i na olelo a mahi i ka 11 o Uenui
- No ke ana ana i ka la 11 o October 1852 Uenui \$2.50.
- No ke kope ana
- No ka hurohoro ana i ka olelo October 15, 1852.

G. M. Robertson
 W. Lee
 J. Hekeaulahao
 J. H. Smith

Eia mafulena. *Anaia o S. Kalama*

\$ 6.00

Aina ma Kahahuna, Honolulu, Oahu.

Apana 1. Kahahala. E hoomaka ma ke kahi Kona o keia Kaha Pahala, ma ka
 pohaku haitonai x ma ka aao maloko o ka pa-aina e pili ana me ke Aluni Puhawina hana
 hon. A e holo i ka Akau 22° N. 1700 Pautu ma ka aao o ka Kalo Kula Ohi a hiki i ke
 Hekei, ke kahi Akau makai o keia. Alaila Akau 75° 30' Hik. 90 Pautu ma ke Hekei hiki i ka
 pohaku x maloko o ka papohaku. Alaila Kona 8° Hik. 45 Pautu, anaila, a me Kona 14°
 Hon. 1700 Pautu ma ka aao maloko o ka Pa-aina a hiki i ka hiki i hana hana i.
 Maloko oia Kahahala 109 Aina.

Apana 2. Lei. E hoomaka ma ke kahi Hekei ma ka aao o keia aino, e pili ana me
 ka aino o Kaniho. A e holo i ka Akau 25° Hon. 94 Pautu ma ka aao me Kaniho a hiki i ke
 Kaniwahakona. Malaila Akau 32° Hon. 1500 Pautu, a me Kona 59° 30' Hon. 64 Pautu
 a me Akau 43° Hon. 47 Pautu ma ka aao me ke Kaniwahakona a hiki i ke kahi o ke Aluni
 aino. Alaila Kona 55° Hon. 59 Pautu ma ka aao me ke Aluni a hiki i ka pahua ma
 ka aino. Malaila Akau Kona 35° Hik. 1700 Pautu, a me Kona 30° Hik. 1700 Pautu ma
 ka aao a me ke Kaniwahakona a me Kaniwahakona a hiki i ka pahua me ke Kaniho. Alaila
 holo i ka Akau 64° Hik. 1700 Pautu ma ka aao o keia me ke Kaniho a hiki i ka hiki i hana hana i a
 puni keia aino.
 Maloko o keia Aino 395 Aina.

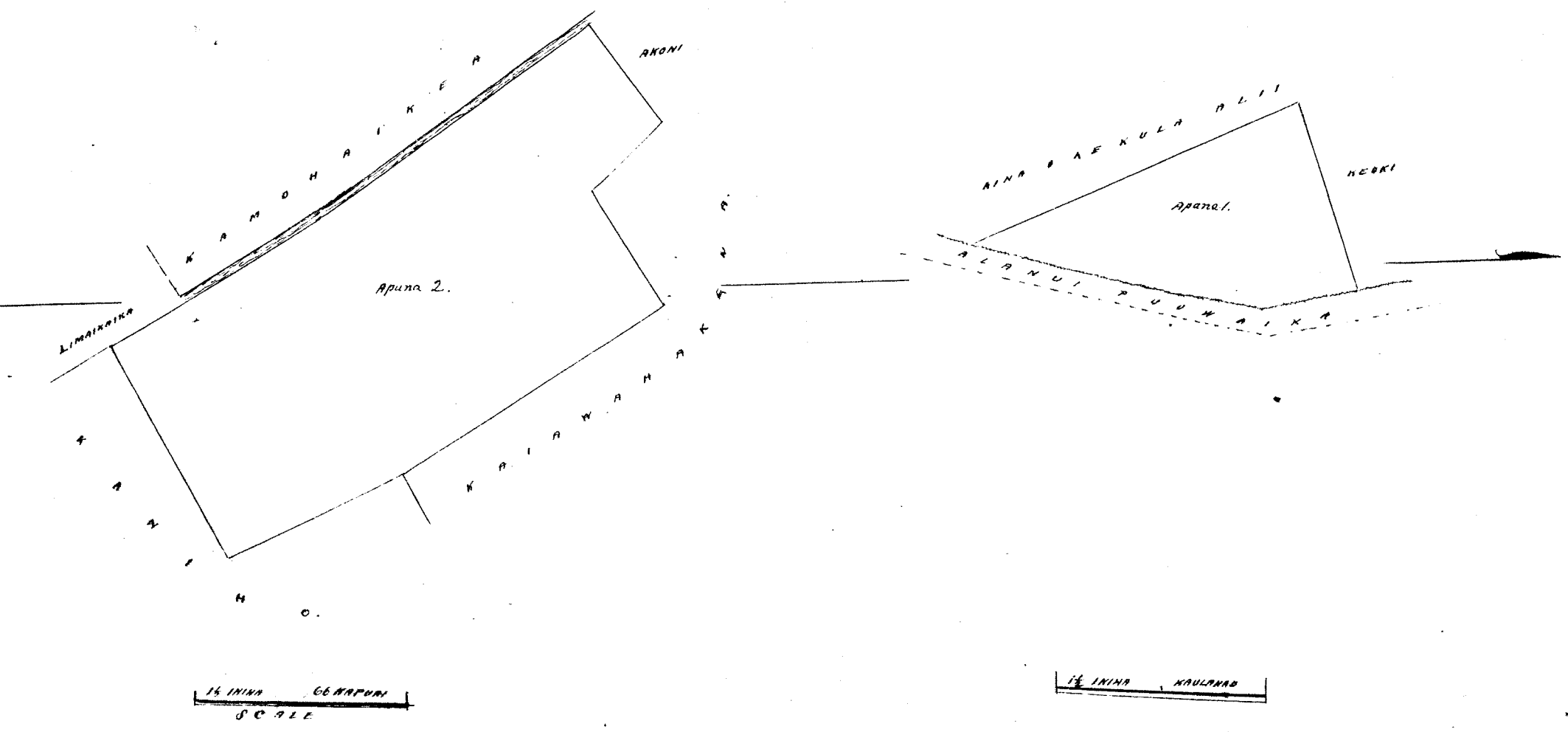

Ua hoi mai via nu kona wahi ma *Hawaii* ma *Honolulu* ma *Hona* ma ka *Mokupuni* o *Oahu* nu ka mea, ua loa ia ia keia wahi no *Waiu* mai kona makuahonowai a me *Kaholo* mai hoi ke *Honohiki* a no *Haiakohi* mai hoi ke *Waiu*, a ua noho heahea oleia o *Waiakea* a hiki i keia manawa.

Oia ka makou e hooke nei nu *Haiakea*; he kuleana hoi kona malalo o ke *Ano Aloha*. Ina e uku mai oia i ke ke *Aupuni* hapaaha; alaila, ua kupaia ia ia ka *Palapala Sila Aloha*.

Pono na ia ia ke uku nu ka hookelelele a me ka hoohele ana i ka olelo. *Pono* *Hona*

No ka aupuni a me ke paiaana i ka olelo ma ka *Mupepa*

No ke kope ana i ka olelo koina

No ka palapala kii

No ka hana ana i ka olelo 27 o *Novemaba* 1851

No ke kope ana i na olelo a me hiki ke 1/2 *Alua*

No ke ana ana i ka olelo 27 o *Ikemaba* 1851 - Ukenia ke ana 1/2.

No ke kope ana

No ka hoohelelele ana i ka olelo. *October 16, 1852.*

G. M. Robertson

M. Lee

J. E. Kaulahau

J. H. Smith

Eia na palena.

Anaia e *J. W. Makalea*.

\$ 3.00

Huluana o *Haiakea* ma *Hawaii* *Hi'aina* ma *Honolulu*

16 Loni a me *Kamohale*. E hoohelelelele ma ke kiihi *Hema* *Makai* o keia pili me ke ke *Honohiki* *Oahu* *Akua* 51° 15' *Hikina* 3 1/2° *Kaul.* i ke *Kamakaole*, *Akua* 16° *Honohana* 5 1/2° *Kaul.* - *Akua* 58° 30' *Honohana* 3 1/2° *Kaul.* - *Akua* 29° 30' *Honohana* 7 1/2° *Kaul.* - *Hema* 83° 30' *Honohana* 4 1/2° *Kaul.* - *Akua* 23° *Honohana* 1 1/2° *Kaul.* hiki i *Puukii*, *Alaila* *Hema* 64° 30' *Honohana* 8 1/2° *Kaul.* i ka lona *paalima*. *Hulu* *Hema* 25° 30' *Hikina* 1 1/2° *Kaul.* - *Hema* 62° *Honohana* 7 1/2° *Kaul.* - *Akua* 27° *Honohana* 2° *Kaul.* - *Hema* 64° 30' *Honohana* 1 1/2° *Kaul.* i ke *Hiikapa*, - *Hema* 27° 30' *Hikina* 4° *Kaul.* i ka lona *paalima* i ka *hiikapa*. *Maia* *Upana* 1 to *Eka*

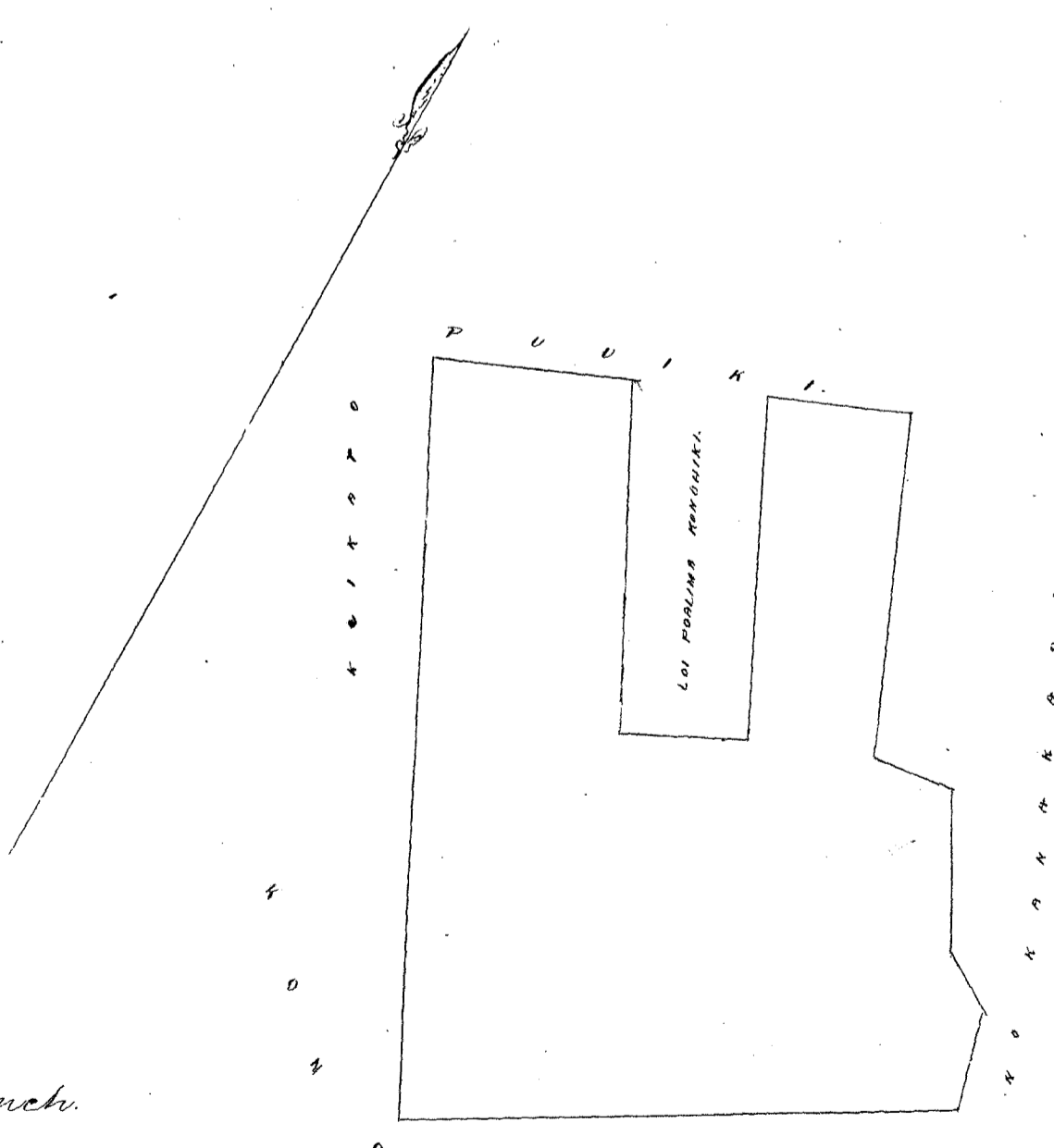

1 chain to an inch.

Helu 680 Opunui

Ua kōi mai oia no kona wahi ma Kalakaa ma Lahaina ma ka Mokupuni o Maui; no ka mea, ua loaa ia ia keia wahi no Kawaihae mai i ka wa o Hoapili a ua nohu keakea oleia a hiki i keia manawa.

Oia ka maku e hooko mai no Opunui; he kuleana hii kona malalo o ke Ano-Atadio. Ima e uku mai oia i ke Opunui hapaha; aiaia, ua kupaia ia ia ka Palapala Pila Merikio. Iono ma e ia ia ke uku oia ka hookoholo a me ka hookoholo ana i ka olelo. Ienei

- No ka rumi a me ke paai ana i ka olelo ma ka Nupepa. # Kem.
- No ke kope ana i ka olelo keina
- No ka palapala hii
- No ka hana ana i ka la 2 o June 1849.
- No ke kope ana i na olelo a wa hoike 1/2 Awa
- No ke ana ana i ka la 20 o Feberuari 1852. Ua kua ke ana.
- No ke kope ana
- No ka hookoholo ana i ka olelo October 23, 1852.

G. M. Robertson
W. L. Hee
J. Kekaulaha
J. H. Smith

\$ 3.00

Oia na palena. Imaia e L. P. Wa.

Ke ana ana i kekahi mau Apua aia o Opunui ma ke Ahupuaa o Kalakaa ma Lahaina, Maui

Apua aia Kalo. E hoomaka ana ma ke kahi Komohana o keia aia ma kahi i pili ai ia Maawau lona me Ohule a holo aku

Akua	44 3/4	Hikina	1.00	Kaulaha ma ke Maawau
Akua	64	Hikina	0.72	"
Akua	17	Komohana	0.17	"
Akua	31	Hikina	0.85	" a hiki i ka auwai
Akua	59	Hikina	0.86	" auwai
Akua	79 1/2	Hikina	0.80	"
Kema	16	Hikina	0.69	" Komohiki a hiki i ka auwai
Kema	45 1/2	Komohana	3.07	" Kaulaha
Kema	17	Komohana	0.45	"
Kema	74	Komohana	1.14	"
Akua	30	Komohana	0.30	" Ohule a hiki i kahi i hoomaka ai.
		Ka Ili	27	Roda

Ua kua ke ana ana
L. P. Wa.

See 24589

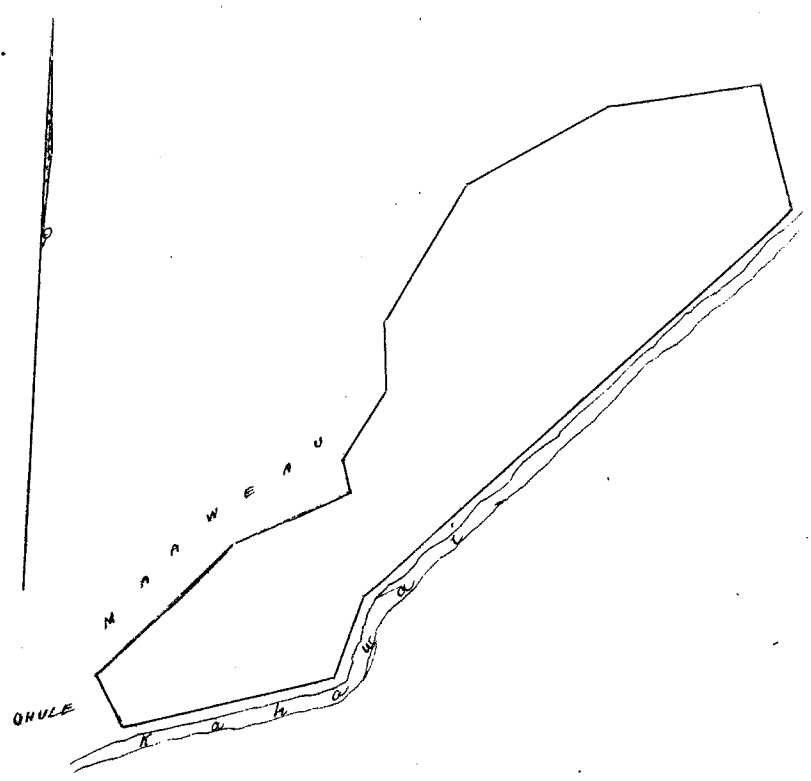

Ua kii mai eia i ke kono wahi ma Pounau, Puhuehu a me Kalakaa ma Lahaina, ma ka Moku o Maui; no ka mea, ua loa ia ia keia wahi i ka makahiki 1838 a mamua aku, a ua noho heahea oleia a hiki i keia manawa.

Cia ka makou e hoohe me i ke Kapu; he kuleana hoi kono ma ka o ke Aun-Abdio. Ima e ukou mai eia i ke ke Aupuni hapaha; alaila, ua kupaia ia ia ka Palapala Sila Abdio.

Ione noa ia ia ke ukou no ka hoohehehe a me ka hoohehehe ana i ke olelo. Ione; —

G. M. Robertson
W. Lee
J. Kekaula
J. H. Smith

No ka rima a me kupaia ana i ke olelo ma ka Moku
No ke kupaia ana i ke olelo kama
No ka palapala hoi
No ka hana ana i ka la 15 o Iune 1849
No ke kupaia ana i ke olelo a me hoi ke
No ke ana ana i ka la — Ua hoohehehe ke ke ana ana \$3.00
No ke kupaia ana
No ka hoohehehe ana i ke olelo Okatoba 23, 1852.

\$ Ken.

\$ 10.00

Cia ma palena. Anaiia e W. P. Alexander

Kapu Helu 649. Ima kono kuleana ma ka o ke Aupuni, Pounau, Puhuehu a me Kalakaa ma Lahaina o Maui. Ione ka wahi ana.

E hoomaka ana ma ke kiki Akau Komohana, a e holo ana
ke kaula ma ka o ke Aupuni

Akau	68 1/2	Kikina	3, 48	Staulahas e fili ana me Polani
Akau	46 1/2	Kikina	1, 96	" "
Akau	65 1/4	Kikina	2, 61	" "
Akau	79 1/2	Kikina	5, 69	" "
Kema	87 1/2	Kikina	8, 07	" "
Kema	14 1/2	Komohana	7, 25	" " ke Kaulakumoa ma Kalakaa
Kema	44 1/2	Komohana	5, 57	" " Puhuehu
Akau	71 1/4	Komohana	4, 02	" "
Kema	82 1/2	Komohana	2, 97	" "
Kema	61	Komohana	4, 67	" "
Akau	33 1/4	Komohana	5, 85	" " Kalakaa
Akau	68 1/2	Komohana	3, 34	" " Pounau i ka wahi i hoomaka ai
		Ma Hei		Umikumamabiku Eka o Eua Kula

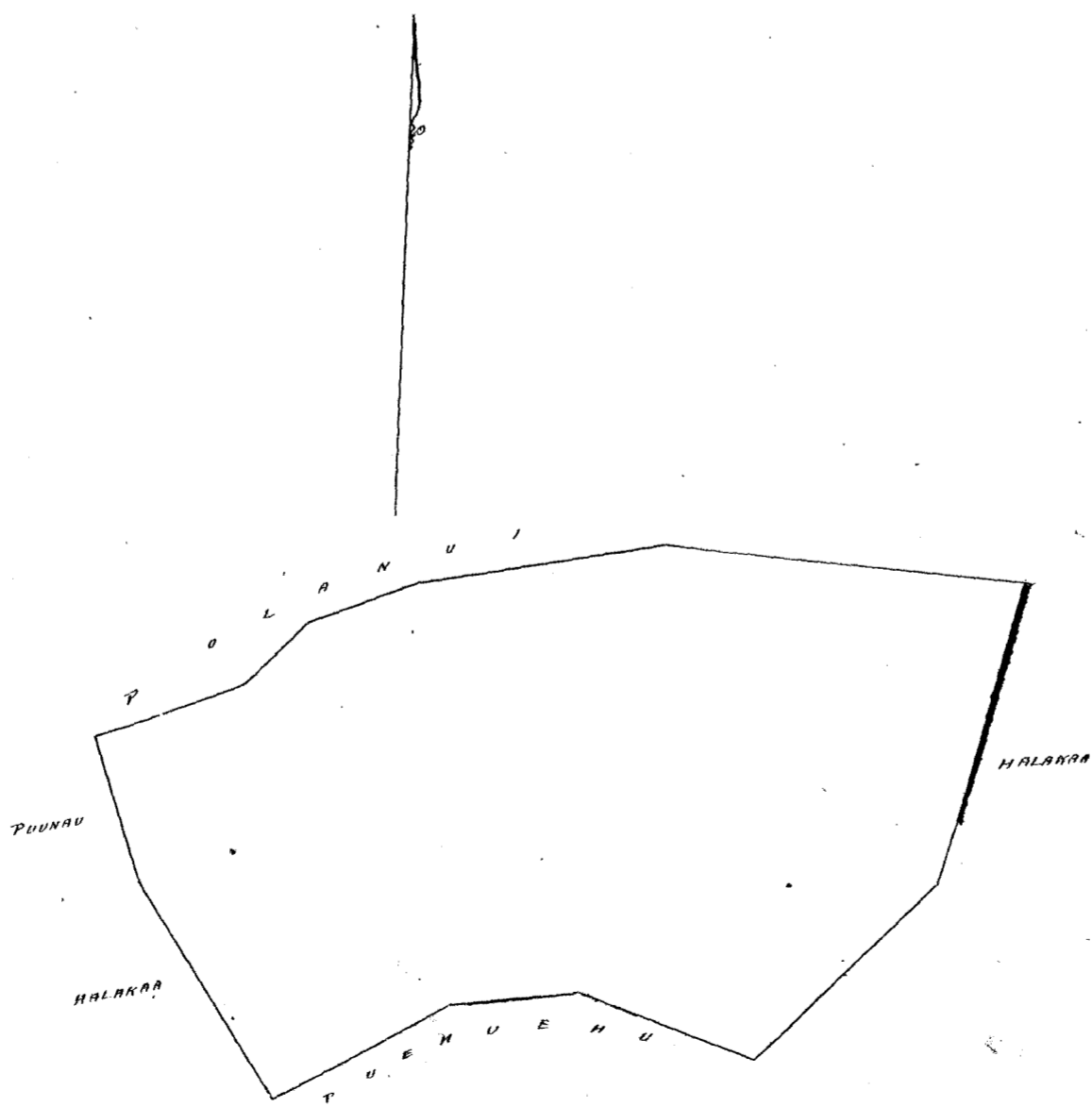

4 Chains, One Inch

Kelii 7590 Kainokane

Ua hoi mai oia no kona mau wahi ma Polani ma Lahaina ma ka Mokupuni o Maui; no ka mea, ua hoi ia ia keia mau wahi ma Makaula mai ka Lani o Polani i ka wa o Hoapili, a ua nolu beahea oia a hiki i keia manawa.

Oia ka mahele o hooko nei no Kainokane; he kuleana hoi kona malalo o ke Ano Aloha. Ina e uku mai oia i ke ke Aupuni hapahele; alaila, ua kuleana ia ia ka Palapala Alo Aloha.

Ke mau ia ia ke uku ma ka hookoholo a me ka hookoholo ana i ka olelo. Penei, -

A Hen.

No ka sumi a me ke paia ana i ka olelo ma ka Mapepa

No ke kope ana i ka olelo koia

No ka palapala kii

G. M. Robertson No ka hana ana i ka la 2^o June 1849

M. Hee

No ke kope ana i ka olelo a me hiki 1/2 Awa

J. Mekaualaha

No ke ana ana i ka la 23^o July 1851. Ukuia ke ana ana

J. H. Smith

No ke kope ana

No ka hookoholo ana i ka olelo October 23, 1852.

Oia ma palena.

Amiaia o P.P. Ua.

\$ 4.007

Ke ana ana i ma Apama ana no Kainokane ma Hoapili ma ke Aupuni o Polani ma Lahaina i Maui. He ana ana.

Apama 1. E hoomaka ana ma ke kiki Akau o keia ana ma kahi i pili ai i ke Ohule a me "Hio". A holo aku kama 55^o Komohana 1.20 Haul. ma ke Ohule; alaila kama 41 1/2 Komohana o. 65 Haul. ma ke Ohule; alaila kama 74 1/2 Komohana 1. Haul. ma ke Ohule a hiki i ke Hoalaka; alaila kama 38^o Hikiina 1.24 Haul. ma ke Hoalaka; alaila Akau 35^o Hikiina 2.95 Haul. ma "Hio" alaila Akau 68^o Komohana o. 25 Haul. ma Hio a hiki i kahi i hoomaka ai.

Ma ia Apama 27 Roda

Apama 2. He ana ana ma ke kiki o Kaakaw. Aupuni o Polani, Lahaina, Maui.

E hoomaka ana ma ke kiki Akau Komohana o keia ana ma kahi i pili ai i ka lani Polani a me ke Hamanala; a holo aku ka awa ma kama 60^o Hikiina 1.33 Haul. ma ka lani polani; alaila kama 35^o Hikiina o. 20 Haul. ma ke Hoalaka; alaila Akau 53 1/2 Hikiina o. 18 Haul. ma ke Hoalaka; alaila kama 34^o Hikiina o. 37 Haul. ma ke Hoalaka; alaila Hikiina 2.47 Haul. ma ke Hoalaka; "Hio" a hiki i ke P. wai; alaila kama 6^o Hikiina o. 17 Haul. ma alaila aku a hiki i ka hawaii; alaila kama 75 1/2 Komohana o. 78 Haul. ma ka hawaii; alaila Komohana 1.41 Haul. ma ka hawaii a hiki i ke kahi i hoomaka ai; alaila Akau 77^o Komohana 2.39 Haul. ma ka hawaii a hiki i ke Hamanala; alaila Akau 22 1/2 Hikiina o. 95 Haul. ma ke Hamanala a hiki i kahi i hoomaka ai.

Ma ia Apama 3 33 Roda

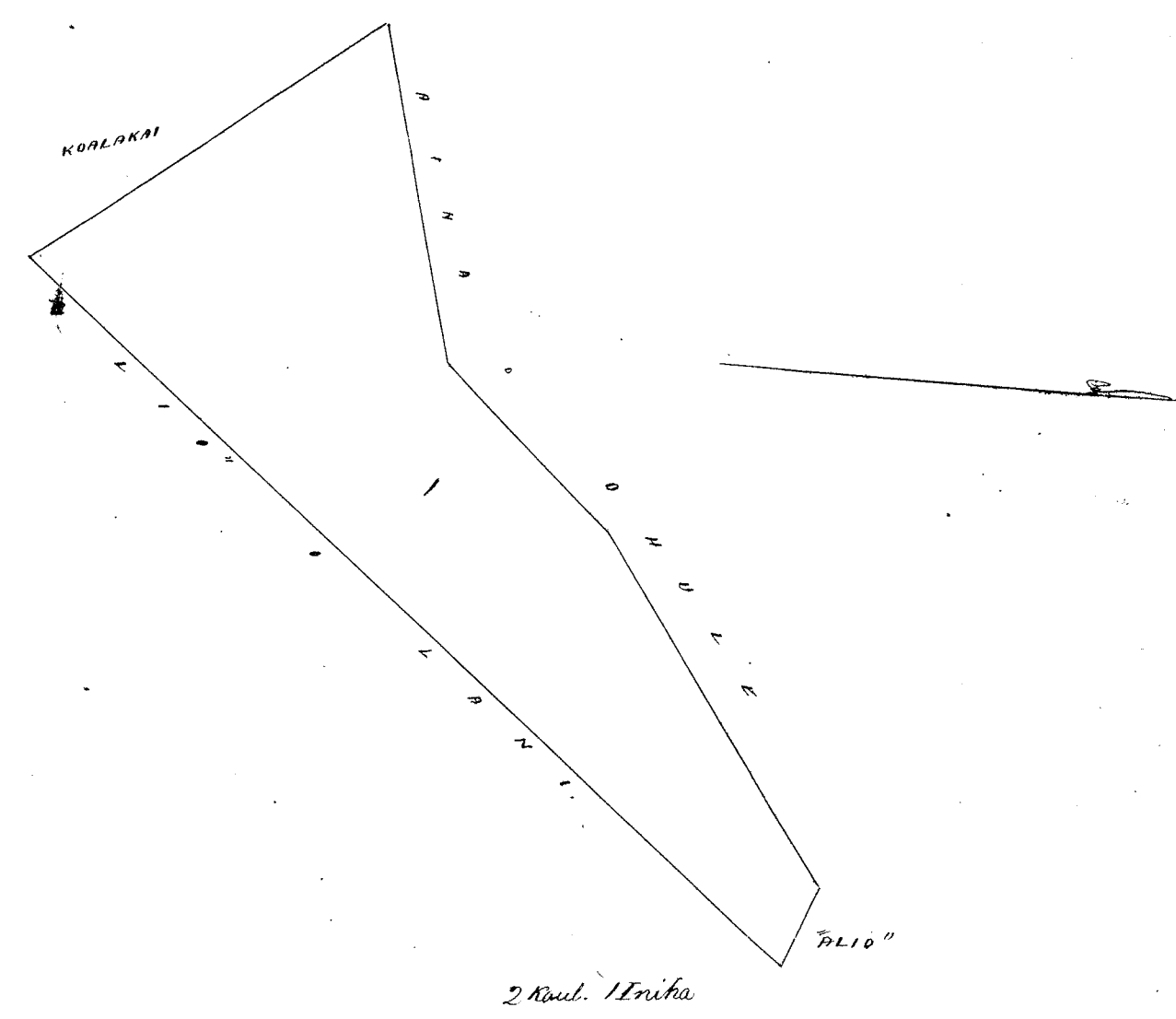
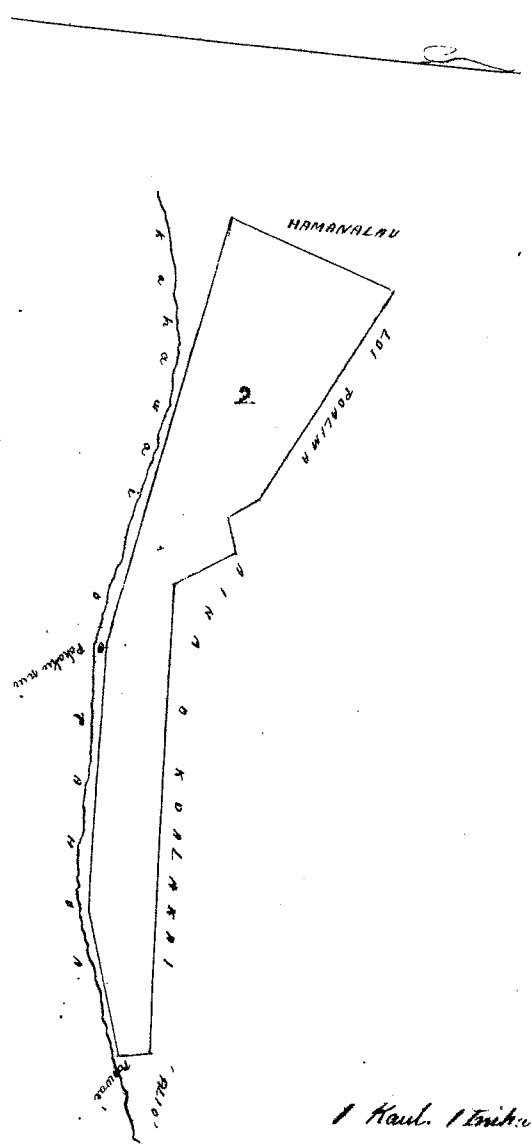

Ua hiki mai oia nu kono wahi ma Polaiti ma Lahaina, ma ke Mokaiunui o Maui; ma ke mea, ua hooia ia keia wahi no Ulumehuheie i ke matakahi 1847 a 1848 paha, a ua noho keakea oia a hiki i keia manawa.

Oia ka motou i hoko nei no Kulaia; ke kuleana hiki kono malalo o ke Ori Alodio. Ana e ukui mai oia i ke ke Auunui hapaha; aiaia, ua kupo ia ia ke Palapala Hele Alodio.

Nono nae ia ia ke ukui no ke hoholo a me ke hoholo ana i ke olelo. I nei,

No ke rumi a me ke pui ana i ke olelo ma ke Aupepa

No ke kope ana i ke olelo koina

No ke palapala hiki

No ke hana ana i ke la 6, 1849 June 1849.

No ke kope ana i ma olelo a ma hiki 1/3 Arar

No ke ana ana i ke la 23 o Iulai 1851. Ukuia ke ana ana

No ke kope ana

No ke hoholo ana i ke olelo. October 25 1852.

G.W. Robertson

W. Lee

A. Kekaulahas

J. H. Smith

Eia na palena.

Aravia o L.P. Wa.

\$ 3 00

Ke ana ana i kekahi Opana Aina o Kulaia ana ke Auunui o Palaiti i Lahaina i Maui.
He Aina Kalo. E hoomaka ana ma ke hiki Komohana o keia aina ma kahi i pili ai i ke Heleluani a me ke Auwai o Hainano, Wholo akua Akau 74 1/2 Hikiina 1,67 Kaul. ma ke Auwai; aiaia, Heina 36 Hikiina 1,23 Kaul. ma ke Kahoekaha a hiki i ke Hamanalanu, aiaia Heina 56 1/4 Komohana 0,97 Kaul. ma ke Hamanalanu, aiaia, Akau 28 Komohana 1,18 Kaul. ma ke Kahoekaha aiaia Heina 7 1/4 Komohana 0,88 Kaul. ma ke Hamanalanu a hiki i ke Heleluani; aiaia Akau 23 Komohana 0,38 Kaul. ma ke Heleluani a hiki i kahi i hoomaka ai.
Ma ia Opana 23 Roda

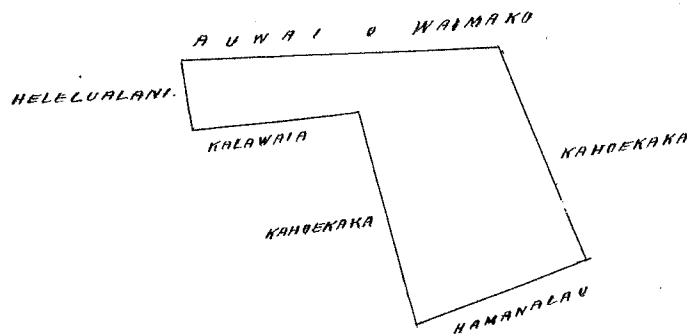

Ana 1 Kaulaha 1 Iriha

Helu 9795 F Kaumauna

Ua hoi mai oia no kona mau wahi ma Nahaalepo, ma Lahauna ma ka Mokupuni o Maui. Ekiolu mau Apawa.

Apana 1. E hoomatika ana ma ke kumu Akau Hikina, a e holo ana			
Akau 71 1/4 Komohana	2, 74	Staub.	e pili ana me ke Kahawai.
Kema 3° Komohana	1, 35	"	" Palau
Akau 84 1/2 Komohana	2, 32	"	"
Kema 33 1/4 Komohana	3, 82	"	" Daniela Ai

Ua hoi mai oia no kona mau wahi ma Nahaalepo ma Lahauna, ma ka Mokupuni o Maui; naha onua, ua loa ia ia keia mau wahi no Daniela Ai mai i ka makahiki 1831, a ua noho keakea oia a hiki i keia manawa.

Oia ka makuu hooko nei no Kaumauna; he kuluana hoi kumu malalo o ke Aua Alodio. Ima e ukia mai oia i ke Aupuni hapaka; alaila, ua kumu ia ia ka Palapala Sila Alodio. Pono nae ia ia ke ukia no ka hookolokolo a me ka hookolo ana i ka olelo. Ima,

- No ka rumi a me ke faai ana i ka olelo ma ka Mupupu \$ Sen.
- No ke kope ana i ka olelo koina
- No ka palapala kii
- G. M. Robertson No ka hana ana i ka la 16. June 1849.
- W. H. C. No ke kope ana i na olelo a ma hoike
- J. Sekautaha No ke ana ana i ka la Ua ukia ke ana ana \$3.00
- W. H. C. No ke kope ana
- No ka hookolo ana i ka olelo October 25, 1852.

Eia na palena. Anai e W. P. Alexander \$ 5.00

Kaumauna Helu 9795 F. Iia kona ana kuluana ma ke Aupuni o Nahaalepo ma Lahauna, Maui. Ekiolu mau Apawa.

Apana 1. E hoomatika ana ma ke kumu Akau Hikina, a e holo ana			
Akau 71 1/4 Komohana	2, 74	Staub.	e pili ana me ke Kahawai
Kema 3° Komohana	1, 35	"	" Palau
Akau 84 1/2 Komohana	2, 32	"	"
Kema 33 1/4 Komohana	3, 82	"	" Daniela Ai
Kema 55° Hikina	0, 69	"	" Hanakaole ma Hanakao
Akau 38° Hikina	0, 99	"	" Daniela Ai
Akau 19 1/4 Hikina	0, 20	"	"
Akau 45° Hikina	1, 00	"	"
Akau 32 1/2 Komohana	0, 88	"	"
Akau 52° Hikina	0, 92	"	"
Kema 39° Hikina	2, 33	"	"
Akau 59 3/4 Hikina	1, 39	"	"
Akau 2 1/4 Komohana	1, 27	"	"
Akau 88 3/4 Hikina	1, 79	"	"
Akau 8 1/2 Hikina	0, 66	"	" Hanalopua a hiki i ka hui i hoomatika ai.
Ka Ai		Hookahi Eka.	

Apana 2. E hoomatika ana ma ke kumu Akau Hikina, a e holo ana			
Kema 37 3/4 Komohana	1, 03	Staub.	e pili ana me Kahawai
Kema 30 1/2 Komohana	3, 92	"	" Oia
Kema 58 1/4 Hikina	1, 80	"	" Hanakaole
Akau 35 3/4 Hikina	3, 80	"	" Daniela Ai
Akau 71 1/4 Komohana	0, 33	"	" Palau
Akau 20 3/4 Komohana	1, 27	"	" i ka hui i hoomatika ai
Ka Ai		Ekiolu Ruda & Umikumamaha Ruda	

Helu 388 Hookei

Ua koi mai oia i kona mau wahi ma *Ahi* mai Tahaina, ma ka Moku o Maui; ma ka mea, ua loa ia ia ma mau wahi marmua ahu o ke Kuni ma Hawaii a ka M. H. 1824, a ua mohe keakea oleia a hiki i keia manawa.

Oia ka mauka e hoko nei i ke Kuni; he kuleana hui kona malalo iho o ke Ano Alodii. Ima e uku mai oia i ke ke Aupuni hapaha; alaila, ua hupuna iwaia ka Palapala Pila Alodii.

Ua wai ia ia ke uku ma ka hokohoko a me ka hokohoko ana i kea olelo. Penei; -

	No ka rumi a me ke pua ana i kea olelo ma ka Muepua.	#	Ken.
	No ke kope ana i kea olelo koima		
G. M. Robertson	No ke palapala kii		
J. H. Kaulahao	No ka hana ana i ka la 16 o Feberuari 1847.		
J. H. Smith	No ke kope ana i kea olelo a na hoike # Awa		
	No ke ana ana i keia		Ukuia ke ana ana # 4.
	No ke kope ana		
	No ke hokohoko ana i kea olelo. Oelopes 28 1852.		
Oia na palena.	Maia e W. P. Alexander	#	500

He palapala hoakaka i ke ana ana i ke kahi Apana Kuleana o Hookei Helu 388, e waiho ana ma ke Ahupuaa o *Ahi* mai Tahaina, Maui.

Apana 1. E hoomaka ana *Herna Komohana*, a e holo ana

Akau 40° Hikiina	2, 97	Kaulahao e pili ana me ke Kuleana	
Akau 45 1/2° Komohana	2, 34	"	Pueo
Herna 33 1/4° Komohana	2, 89	"	Timoteo
Herna 34° Hikiina	1, 39	"	"
Herna 53 1/2° Hikiina	0, 73	"	"

a hiki i kahi i hoomaka ai. *Ka Ali* E lua Ruda a me Kanakolu kumamahi Roda.

Apana 2. He palapala hoakaka i ke ana ana i ke kahi Pahala Kuleana o Hookei Helu 388, e waiho ana ma ke Ahupuaa o *Ahi*, ma Tahaina, Maui.

E hoomaka ana ma ke kahi Akau o keia palapala, a e holo ana

Herna 38 1/4° Komohana	1, 16	Kaulahao e pili ana me ke Akoni	
Herna 47° Hikiina	1, 44	"	Alanui Aupuni
Akau 42 3/4° Hikiina	0, 88	"	ko Kimo Nowlein
Akau 36 1/2° Komohana	1, 54	"	ka Loi o Kuleana

a hiki i kahi i hoomaka ai. *Ka Ali* He kakuwakuwamahi Roda.

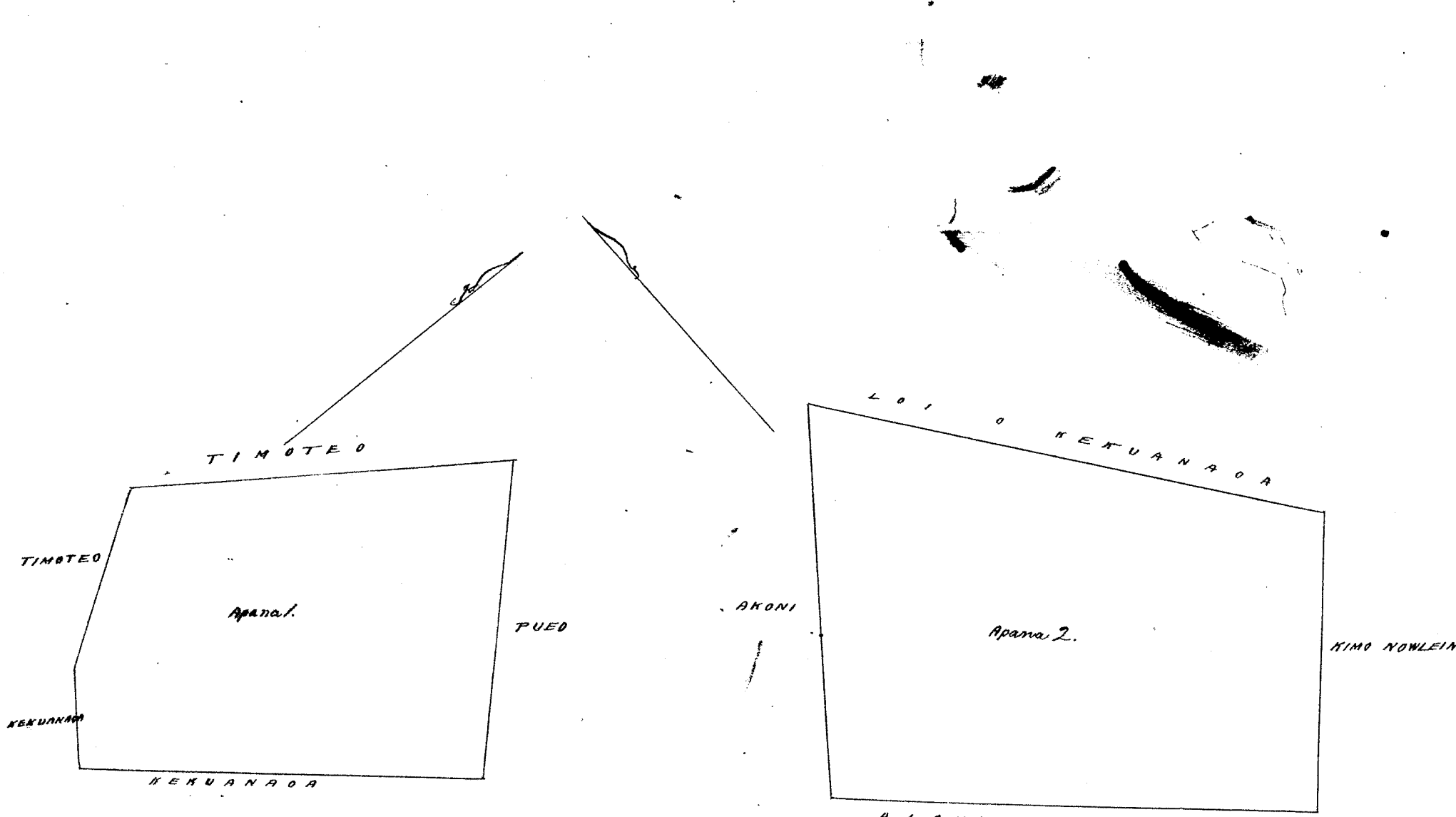

1 Mau. 1 Incha.

Ua koi mai oia me konna mai wahi ma Kauluwela ma Honolulu, ma ka Mokupuni e
Oia, me ka mea, ua loaa ia ia keia mau wahi no Kauluwela mai mamua ahu o ka Makahiki 1829, a
ua hiki mai o Kamaile ka Luma Konoheki mau, a ua holo mai, aole keakea, a ua mohe keakea oleia a hiki
i keia manawa.

Oia ka makou e hoohe me nei Pouhiva, he kuleana hoi konna matato o ke Auniolelo. Ina e ulu
mai oia i konoheki kapaheka; aiaia, ua kupaia iaia ka Palapala Pila Aolelo
Pouhiva ma iaia ke ulu no ka hoohekeke a me ka hoohekeke ana i ka olelo. Peni;

Hen

No ka runu a me ke pai ana i ka olelo ma ka Nupupu.

No ke kope ana i ka olelo konna

G. M. Robertson

W. Shee

J. Kaula

J. H. Smith

No ka palapala kii

No ka kama ana i ka la 16 o Augate 1850.

No ke kope ana i na olelo a ma hoihe 1/2 Aoa

No ke ana ana i ka la 9 o Maraki 1852.

No ke kope ana

No ka hoohekeke ana i ka olelo October 27, 1852.

600

Eia ma palena.

Aiaia e J. Kama

Apana 1. 14 Loo Kalo ma Kauluwela, Honolulu, Oahu.

E hoohekeke ana ma ke kiki e pili ana ma ke Alamui, a e holo ana Kama 46° Hikiina, 90
pauku, aiaia holo hoi Kama 67° Hikiina 1 Kaul. e pili ana me ke Pala, a e holo Aka 45° Hikiina 90 pauku
e pili ana me Konoheki, aiaia Aka 49° Konoheka 7. 30 Kaul. e pili ana o Konoheki Ana 3 Wm. L. Lee, a me
Kauahi, aiaia holo Aka 65° Konoheka 2. 20 Kaul. e pili ana ke Kauluwela, aiaia ma e Kama 20° Konoheka
hona 2, 10 Kaul. e pili ana o Kamaheka, aiaia holo Kama 71 Hikiina 3 Kaul. e pili ana o Pala, aiaia holo
hona a pili i ka Loo Kalo e holo Kama 57° Hikiina 4 Kaul. e pili o Pala, a hiki i ka hiki i hoohekeke ai.

Ka Ili 1 Eka, 1 Ruda, 39 Roda

Apana 2. Kauluwela ma Kauluwela, Honolulu, Oahu.

E hoohekeke ana ma ke kiki Konoheka e pili ana me ke Kauluwela a me ke Konoheki, aiaia
holo Kama 49° Hikiina 2 Kaul. e pili ana Alamui, a e holo Aka 49° Hikiina 1. 20 Kaul. aiaia holo hoi a e
a pili me Konoheki, Aka 44° Konoheka 2. 30 Kaul. e pili ana me Konoheki, Kama 43° Konoheka 1, 40
Kaul. a e pili ana Konoheki a hiki i ka hiki i hoohekeke ai.

Eia konna ili 1 Ruda, 4 Roda.

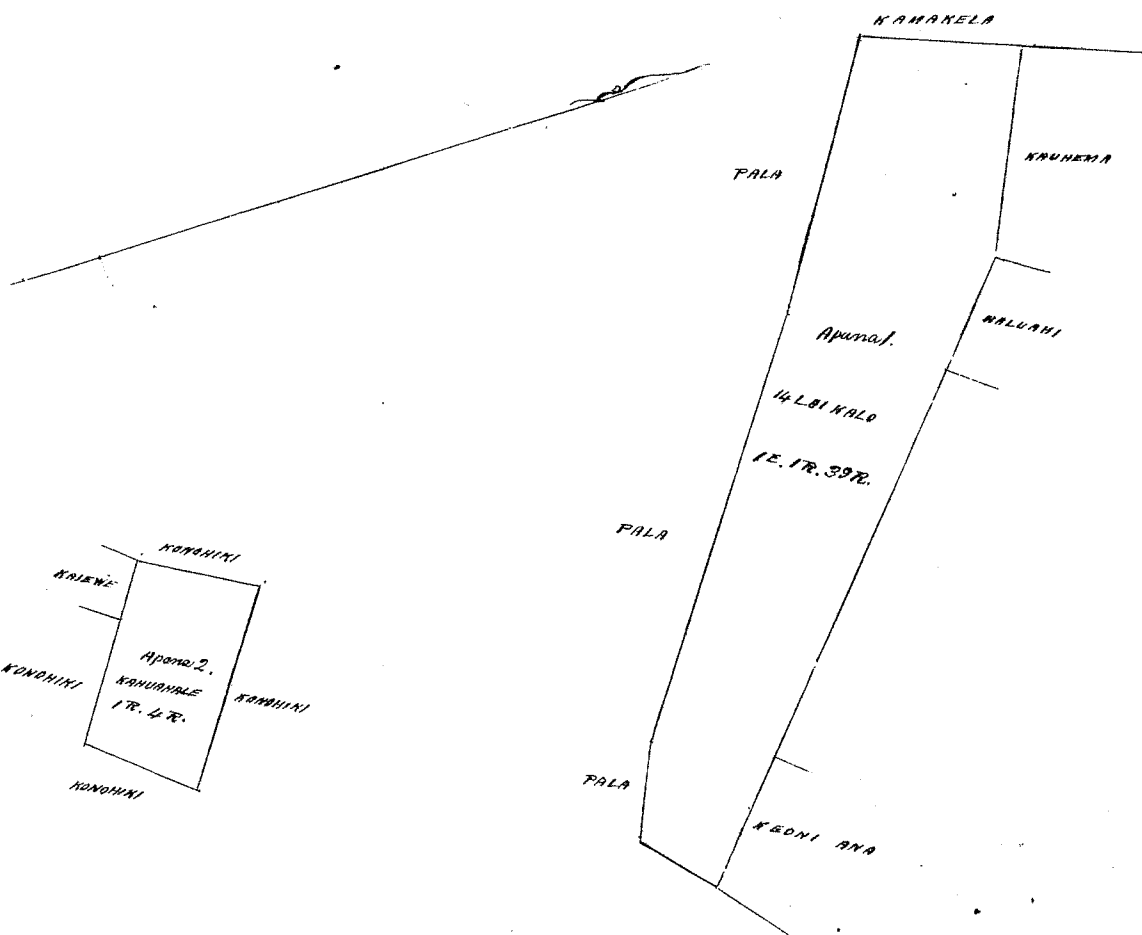

Helu 334 ^{B. n.} Kaitiaki

Mai Awaru 71 mai

Ua koi mai oia i kona mau wahi ma Nihi, ma Honolulu, Oahu, ma Nihi, ma ka Moku o Nihi o Oahu; no ka mea, ua loa ia i keia mau wahi no Hawaii mai kona matuakane i ka matuakani 1838, a ua loa hoi i kona matuakane i ka maua o Kamehameha I, a ua noho mau no Hawaii malaila a hiki i kona make ana, hoi i keia wahi ia Kaitiaki kama keiki, a ua noho keakea oia oia a hiki i kona make ana iho nei i ka M.H. a hoi i keia mau wahi ia Kaitiaki kama keiki, a ua noho keakea oia a hiki i keia maua.

Oia ka matu o hoko nei no Kaitiaki; ke kuleana hoi kona malalo o ke Awa Alodii. Ima o utu mai oia i keia aupuni hapu, alaila, ua kopro ia i ka Palapala Ika Alodii. Ima mai ia i ke utu ara ka hoko kolo a ma ka hoko ana i ka olelo. Penei,

- No ka rumi a me ke pua ana i ka olelo ma ka Kupu.
- No ke kope ana i ka olelo kama
- No ka palapala kii
- No ka hana ana i ka 8 o Feberuari 1850
- No ke kope ana i ma olelo a ma hiki 1 Awaru
- No ke ana ana i ka 6 o Augate 1852. Ukaia ke ana ana \$12.00
- No ke kope ana
- No ka hoko ana i ka olelo October 27, 1852.

G. M. Robertson
 W. Lee
 J. Kekaulaha
 V. H. Smith

1/2 Kem.

\$ 5.00

Eia na palapala. Aniaia o S. Kalamia.

Ma Kuleana o Kaitiaki ma Nihi, Honolulu, Oahu.

Apawa 1. 3 Loi. E hoomaka ma ke kahi Komohana o keia, a e holo Awaru 23° Hiki. 192 Pautu, a Awaru 53° Hiki. 54 Pautu, a Awaru 11° Hiki. 97 Pautu ana ka aira o ke Honolulu ia Hoco a hiki i ka palapala o Nihi ma Nihi, - Alaila Awaru 31 1/2 Hiki. 25 Pautu ma Nihi, a Hema 48° Hiki. 37 Pautu ma Nihi ma ka palapala o Nihi ma Nihi, - Alaila Hema 2° Hiki. 75 Pautu, a Hema 27 1/2 Homa 142 Pautu, a ma Hema 40 1/2 Hiki. 82 Pautu, a Hema 35° Homa. 135 Pautu, a Hema 62 1/2 Homa. 33 Pautu, kahi Hema, a Awaru 36° Homa. 130 Pautu ma ka aira o ke Honolulu a hiki i kahi i hoomaka i. 39/100 Eka.

Apawa 2. Kuleana Nihi Kupu. E hoomaka ma ke kahi Awaru ma keia, fili ana ma ke kahi Hiki ma keia o ka Loi malalo o ke Honolulu, a e holo i ka Hema 40° Homa. 66 Kupu ma Nihi a hiki i ke kahi Komohana, - Alaila Hema 50° Hiki. 36 Kupu, kahi, a ma Awaru 40° Hiki. 66 Kupu, kahi, a ma Awaru 50° Homa. 36 Kupu ma ka palapala Kuleana, a ma fenua i ka aira o ke Honolulu a hiki i kahi i hoomaka i. 66 Anana.

Apawa 3. 6 Loi. E hoomaka ma ke kahi Hiki ma keia, E holo ana Hema 35° Homa. 3. 44 Kaul. ma ka aira o James Robinson, - Alaila Awaru 40° Homa. 1. 35 Kaul. a Awaru 18° Hiki. 58 Pautu, keakea, a Hema Lima Hema 14 Pautu, kahi, a Awaru 3 1/2 Hiki. 64 Pautu, a Awaru 27° Hiki. 1. 84 Kaul. a Hema 58 1/2 Hiki. 2. 27 Kaul. ma fenua i ke Honolulu a hiki i kahi i hoomaka i. 1/100 Eka.

Apawa 4. Mau Loi. 5. Kuleana Maui. E hoomaka ma ke kahi Awaru Maui o keia ma ka mimi pohaku o ka Loi, awaru ma Nihi, a e holo ma ke Ala lili ma ka aira o ke Honolulu, Awaru 63° Hiki. 36 Pautu, a Hema 86° Hiki. 64 Pautu, a Awaru 36 1/2 Hiki. 142 Pautu a hiki i ka pohaku ma ke Ala lili ma ka aira o James Robinson, Alaila Hema 59 1/2 Hiki. 45 Pautu, kahi, a Hema Lima Awaru 20 Pautu, a Hema 54° Hiki. 36 Pautu fili ana ma ke James Robinson a hiki i kahi i ka palapala, - Alaila Hema 30° Homa. 3. 30 Kaul. iho i ka hiki i ka lili Awaru o ka muna Awaru o ka Nihi ma Nihi, - Alaila holo pohaku ma ka lili ma keia o ka muna Awaru a hiki i kahi i hoomaka i. 34/100 Eka.

Apawa 5. 1 Loko ma Nihi, Loko o Nihi. E hoomaka ma ke kahi Komohana Maui o keia, a e holo Hema 89° Hiki. 96 Pautu, a Awaru 77° Hiki. 116 Pautu ma Honolulu a hiki i ka palapala ma ka lili Awaru ma keia, Alaila Awaru 1 1/2 Homa. 148 Pautu, kahi, a Awaru 88 1/2 Homa. 2. 05 Kaul. fili ana ma Honolulu ia mau awaru a hiki i kahi i ka lili Awaru, Alaila Hema Hoko ma Nihi. 180 Pautu ma ka aira a hiki i kahi i hoomaka i. 35 1/2/100 Eka.

Apawa 6. Palapala 10 Loi ma Nihi, Loko o Nihi. E hoomaka ma ke kahi Hiki Maui o keia, ma ka lili ma keia o ke Ala lili o Honolulu, a e holo Awaru 9° Homa. 90 Pautu, a Awaru 2° Hiki. 120 Pautu, a Awaru 5° Homa. 2 Kaul. a Awaru 9° Hiki. 50 Pautu ma ka lili ma keia o ke Ala lili a hiki i ke kahi Hiki Maui ma keia, - Alaila Awaru 82° Homa. 52 Pautu, a Hema 77 1/2 Homa. 45 Pautu, kahi, a Hema 2° Homa. 3. 42 Kaul. a Hema 4° Hiki. 128 Pautu, a Awaru 83 1/2 Hiki. 116 Pautu, fili ana ma Honolulu ia mau awaru a hiki i kahi i hoomaka i. 5/10 Eka

35
 61
 66
 34
 25
 19
 72
 66
 64
 64 - 1. 34. 66

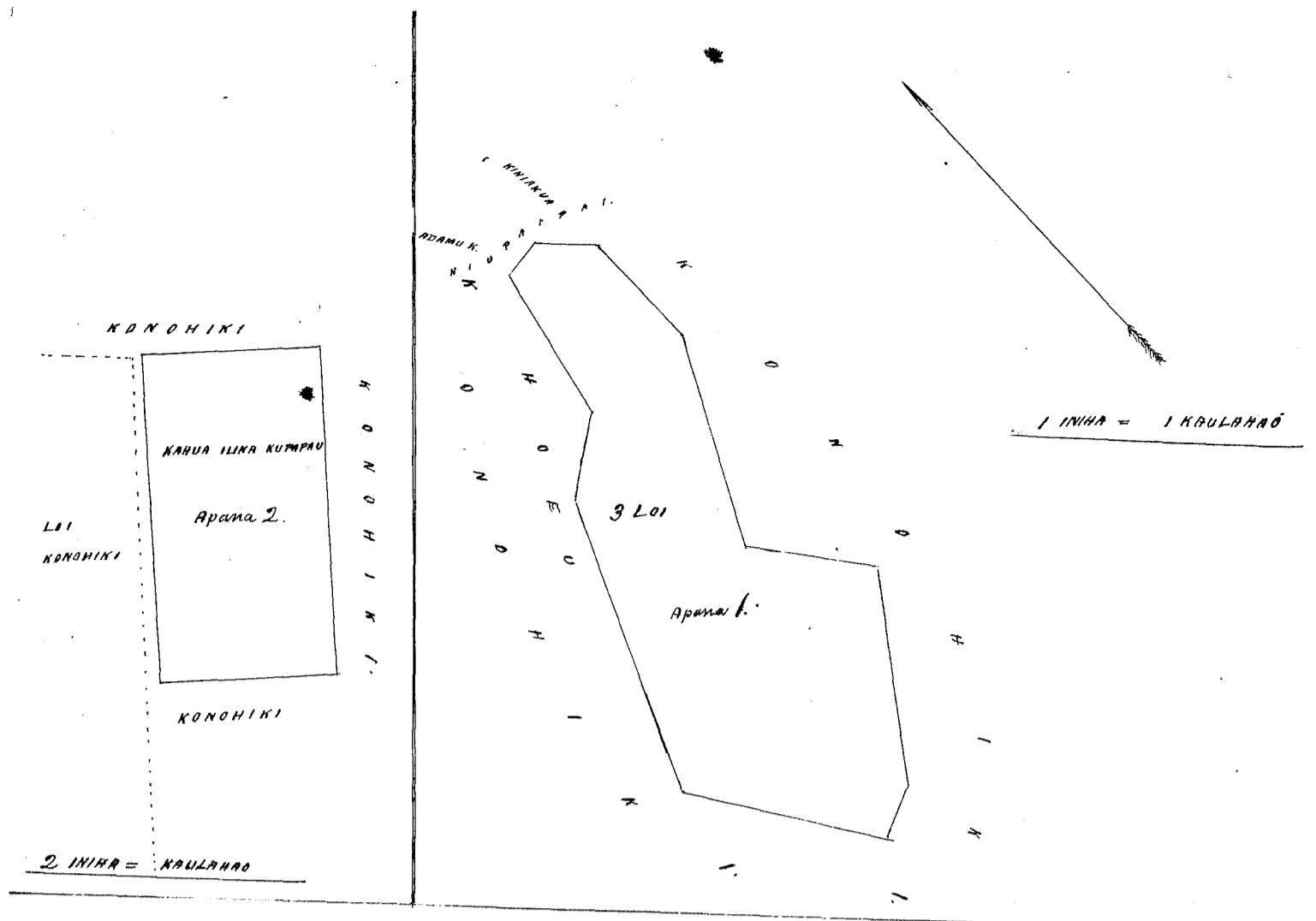

Olelohoakaka

Ehuu Kope ana o Keia Huleama,
 lili ma ka Apana 1. Aka, makope
 iho oia Kope ana, ua hoolohia ka
 Apana 2 malaila, a o Keia Kope ana
 ka i'polohia, a ua hoolohia ma Keia Kope ana.
 Aka, o na Apana 2 ce ma Keia Kope ana
 Ua hoolohia me Keia, a o ka Apana 2 malaila,
 ua hoolohia maauwi.

October 27, 1852.

J. P. Nailili
 Kakaulele o na L.H.K.

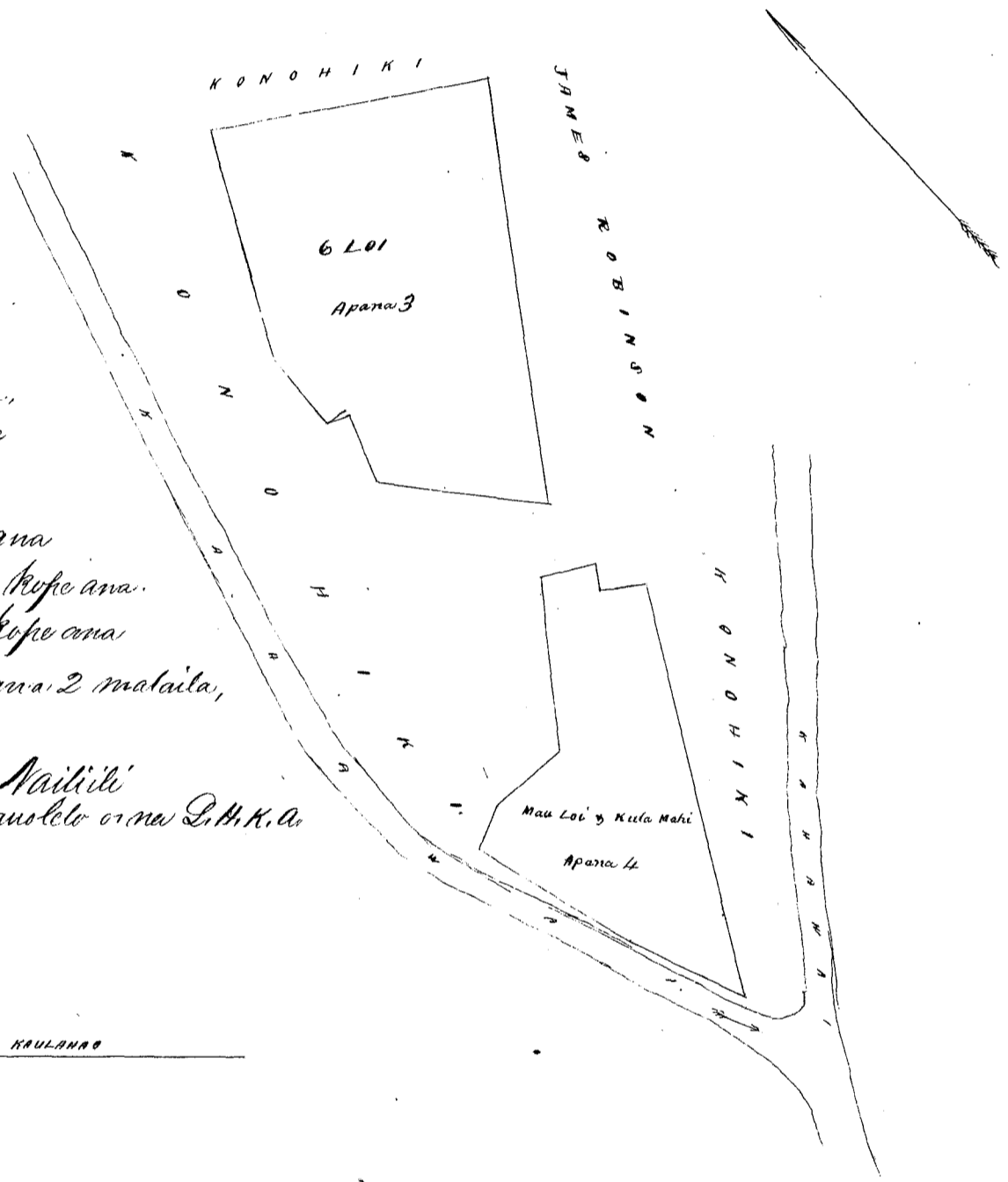

3/4 INIHA = KAULANA

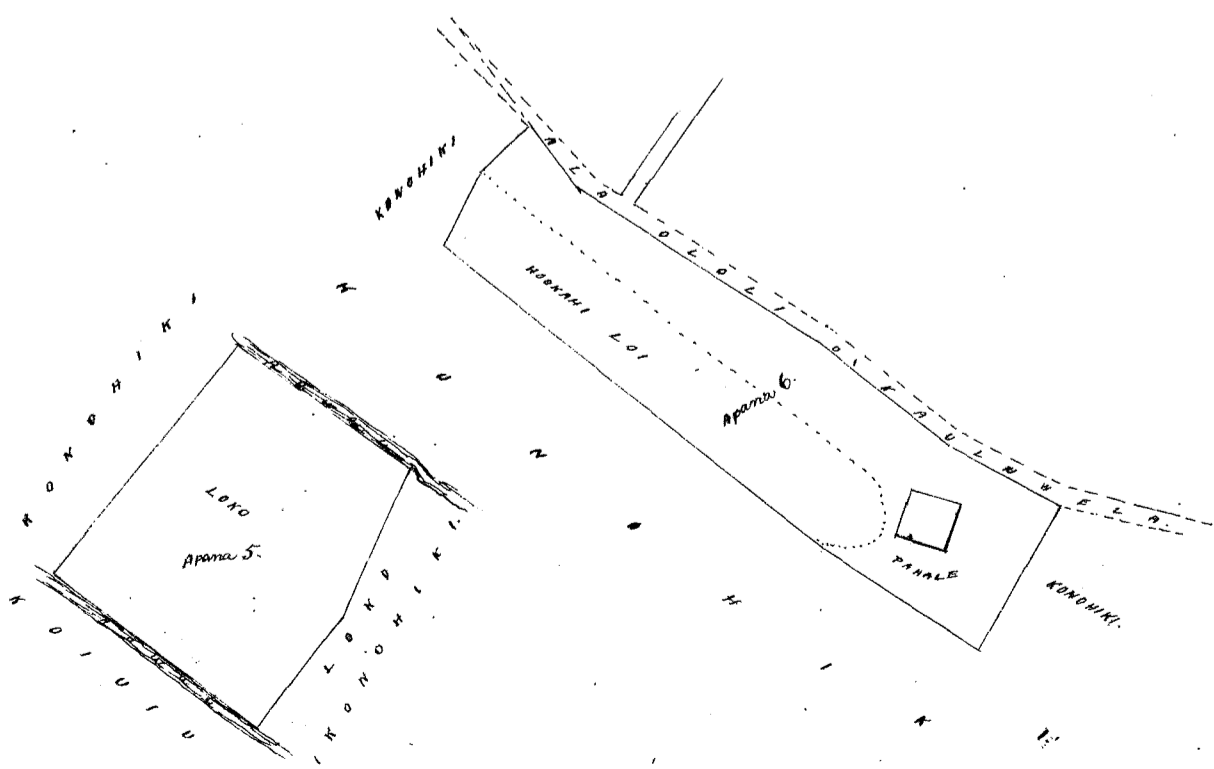

3/4 INIHA = KAULANA

Helu 7632 I. Kahookano

Ua kovi mai oia no kona mau wahi ma Kelaweia ma Tahaina, ma ke Mokupuni o Maui, ma ka mea, ua laka ia ia keia mau wahi no Hoapili Wahine mai i ka makahiki 1836, a ua noho keakea oia a hiki i keia manawa.

Oia ka makou e hoko nei no I. Kahookano; he kuleana hoikekua maalo o ke Alo Alo. Aua e ukou mai oia i ke ke Aupuni kapakapa; alaila, ua kuleana ia ia ka Palapala Alo Alo.

Ua ma i ia i ke ukou no ka hoholo hoholo a me ka hoholo ana i ka olelo. Penei, -

- G. M. Robertson
 - W. Lee
 - A. Hekeubahao
 - J. H. Smith
- No ke kupa a me ke paia ana i ka olelo ma ka Mepepa.
 - No ke kupa ana i ka olelo keia
 - No ka palapala keia
 - No ka hana ana i ka law 31 o Mei 1852.
 - No ke kupa ana i ka olelo ma hiki 1/3 Aua.
 - No ke kupa ana i ka law 29 o July 1851. - Ua ukouia ke ana ana.
 - No ke kupa ana
 - No ka hoholo ana i ka olelo October 27, 1852.

\$ 100

Eia ma palena. Aua e L.S. Ua.

\$ 4.00

He ana ana i kekahi Apana aua o I. Kahookano ma ke Aupuni o Kelaweia ma Tahaina i Maui.

He Ana Ana. E hōmaka ana ma ke kiki Heana o keia ana, ma kahi i fili ai i ka pa mau ana o keia ana a me ka ana o ke Kulanui o Tahainaluna; a me ka pa hoi o e kaawale ai ua ana nei o Kulanui a me ke Heaweluaole. U holo aku Akau 30° Hikiina 2.35 Haul. ma ka pa ana o Kulanui, alaila Akau 48° Hikiina 2.52 Haul. ma ka pa, alaila Akau 6° Homohana 6.39 Haul. ma ka ana o Kulanui, alaila Akau 69° Hikiina 0.29 Haul. ma ka ana a hiki i ka auwai, alaila Akau 40° Hikiina 1.51 Haul. ma ka auwai, alaila Akau 60 1/2 Hikiina 1.55 Haul. ma ka auwai, alaila Akau 71° Hikiina 3.00 Haul. ma ka auwai, alaila Akau 28 1/2 Homohana 0.91 Haul. ma ke Heaweluaole a hiki i ka pali, alaila Heana Akau 84 1/2 Homohana 0.94 Haul. ma ka pali, alaila Heana 88 1/2 Homohana 1.12 Haul. ma ka pali, alaila Heana 67° Homohana 0.54 Haul. ma ka pali, alaila Heana 50° Homohana 5.12 Haul. ma ka pali, alaila Heana 76° Homohana 1.80 Haul. ma ka pali, alaila Heana 35 Homohana 2.35 Haul. ma ka pali a hiki i ka pa e kaawale ai keia ana a me ke C. Kanaina; alaila Heana 35° Hikiina 1.92 Haul. e holo ana ma ka pa a hiki i kekahi i hōmaka ai. Ma wa Apana 1 Eka 1 Puda 17 Poda.

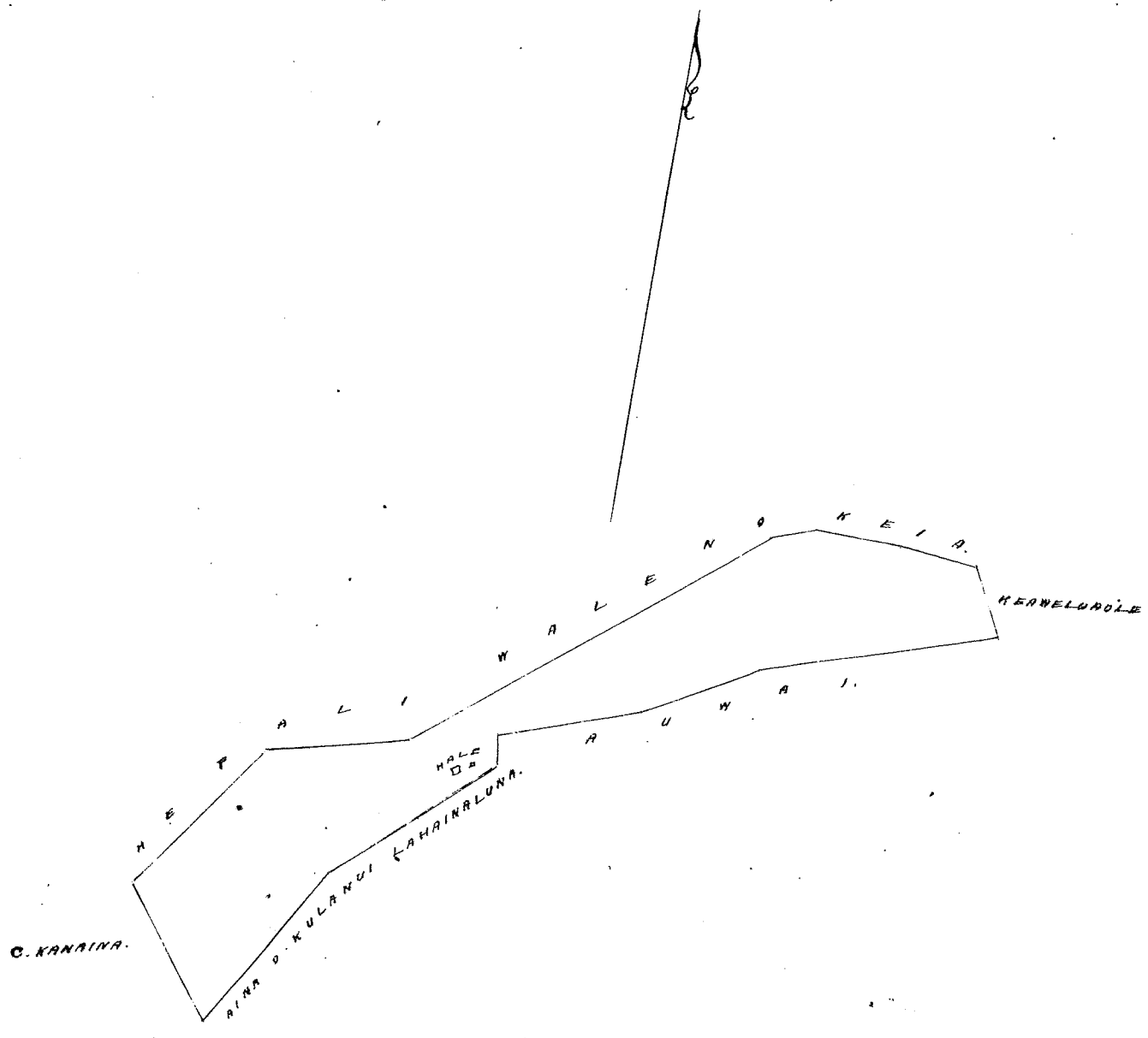

Ana 2 Haulakao = 1 Incha.

Ua kōi mai oia no kona wahi, ma Kapahumanamana ma Lahaina ma ka Mokupuni o Maui; no ka mea, ua hāw iā iā keia wahi no Waiānapani hāua o Kalaimoku mai in amua aku o ka wā i ke Kumu Kūmāwai i ka mākaheke 1839, a ua noho mau no oia mākaheke a hiki i keia mānawa. Ika, o ka wahi o keia kuleana o Pupuka, ua lilo iā Kūhāna ka wāhine o Hekekepuni, a ua hōkōia mānawa ma ka la 25 o June 1851, a o ka hiki i keia mākaheke ma ke Kūi mākaheke, o ke Pupuka wahi iā, a ua noho keakea hon oleia a hiki i keia mānawa.

Oia ka mākaheke e hōkō me i no Pupuka, he kuleana hiki kona mākaheke iho o ke Amō Alodio. Ina o ka mākaheke iā i ke ke Kūmāwai mākaheke; a hāua, ua hōkōia iā i ka Palapala Pūlo Alodio. Iono mākaheke iā i ke mākaheke hōkōlo a me ka hōkōlo mākaheke i ka olelo. Ionei, -

No ka omni a me ke faai ma i ka olelo ma ka Mupupa.
 No ke kope ana i ma olelo koma
 No ka palapala hii
 No ka hāua ma i ka la 25 o Iulai 1851
 No ke kope ma i ma olelo a ma hiki i hāua
 No ke mākaheke i ka la Ua ukia i ke mākaheke \$150;
 No ke kope ma
 No ke hōkōlo mākaheke i ka olelo October 27, 1852.

G. M. Robertson
 W. A. He
 J. K. Kaulahao
 J. H. Smith

Oia ma palapala. Anai i W. P. Alexander

\$ 5100

Pahale no Pupuka (no Hanu) ka hōkōlo, Oia ma Kapahumanamana, Lahaina, Maui. E hōkōlo ma ke hiki Kōma Kōkōlo, a e hōlo ma
 Akau 51° Kōkōlo 1, 25 Kaulahao ma ke Ua Kōkōlo
 Kōma 42 1/2 Kōkōlo 1, 34 " e hiki ma me ke Kōkōlo.
 Kōma 38 1/4 Kōkōlo 1, 20 " " " Kōkōlo
 Akau 46 1/4 Kōkōlo 1, 67 " " " Kōkōlo
 a hiki i ka hiki i hōkōlo ma i.
 Ka Ii Kwakalua Kumamāiwa Roda

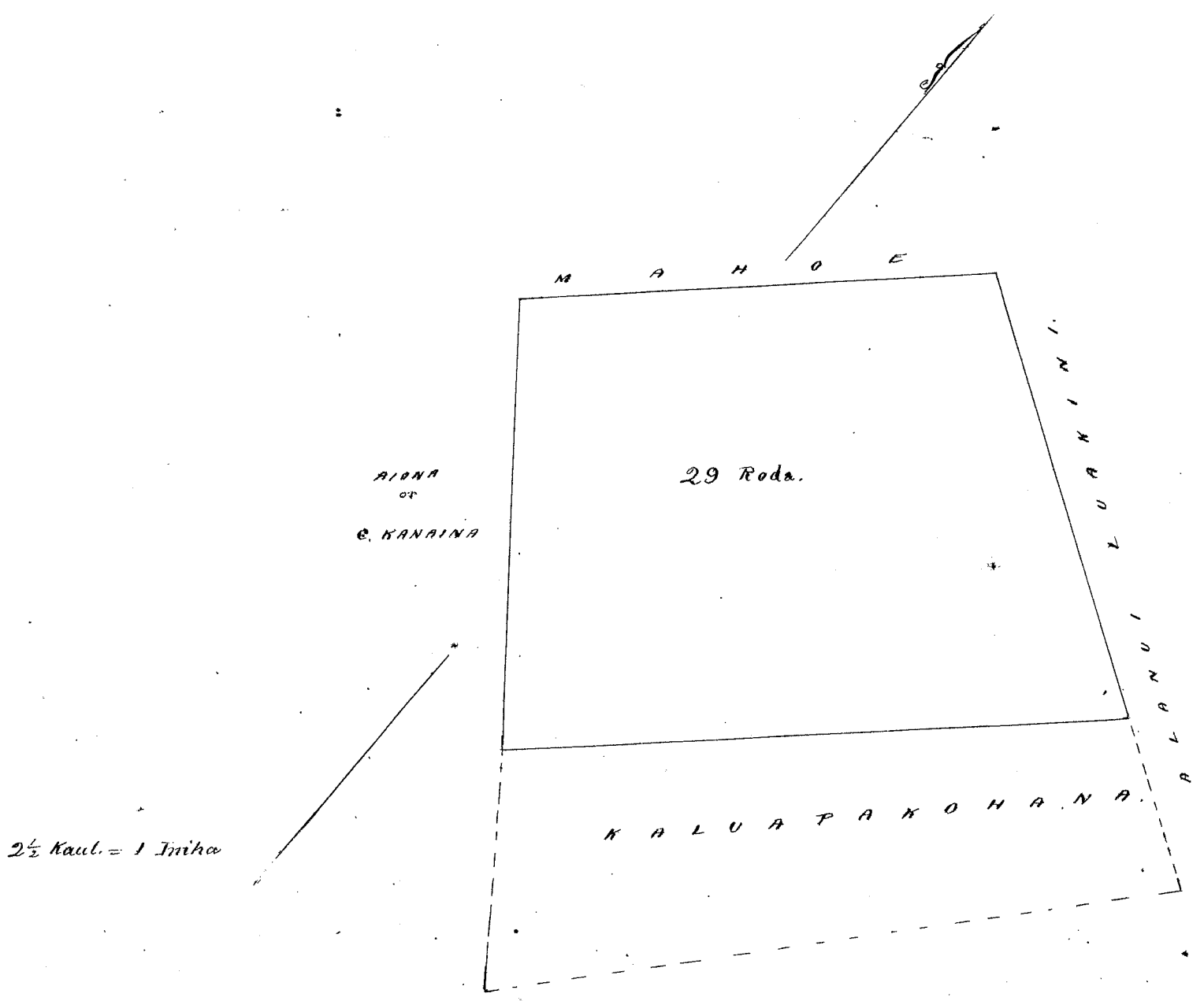

Ua kōi mai oia no kona wahi ma Paohi ma Tahaina, ma ka Mokupuni o Maui, no ka mea, ua
loa ia ia keia wahi no Kalou mai, a no Kamamalu mai hoi ke Kalou, a no Liko Liko mai hoi ke Kamamalu,
a ua noho keakea oia a hiki i keia manawa.

Oia ka maku a hōke mai no Ukikiki, he kuleana hoi kona matalo iho o ke Omo-Olo-Omo ma
uku mai oia i ke ke Aupuni hapaha; alaila, ua kōpuna ia ia ke Palapala Ika Olo-Olo.

Pono maia ia ke uku no ka hōkōlolo a me ka hōhōlo ana i ka olelo. Penei,

§ Kō.

No ka rumi a me ke pua ana i ka olelo ma ka Mupua.

No ke kōpe ana i ka olelo hōina

No ka palapala kii

G. M. Robertson

W. Shee

No ka hana ana i ka la 19 o Feberuari 1847 & 20 Feb. 1847.

No ke kōpe ana i ka olelo a mahi ke 22 Aoro, 1 a.

No ke ana ana i ka la

Ukui ke ana ana \$2.00

J. Hekeulaha

D. H. Smith

No ke kōpe ana

No ka hōhōlo ana i ka olelo. Novemata 1, 1852.

§ 300

Oia ma palama.

Anaia o W. P. Alexander

Ukikiki Helu 500. He kōna kuleana hapaha ma ke Aupuni o Paohi, ma Tahaina, ma Maui.

E hōmaka ana ma ke kōi Akaui Kikina, a e hōlo ana

Helu 42 1/2 Kikina Komohana 1, 55 Kaulaha a pili ana me Kamakini

Helu 42 1/2 Kikina 1, 59 " " Hanaina

Akaui 53 1/2 Kikina 1, 63 " " Kaula

Akaui 44 Komohana 1, 80 " " Hanaina

a hiki hoi aku i ka hōmaka ai.

Ka Aki Hookahi Ruda & Ekolu Ruda

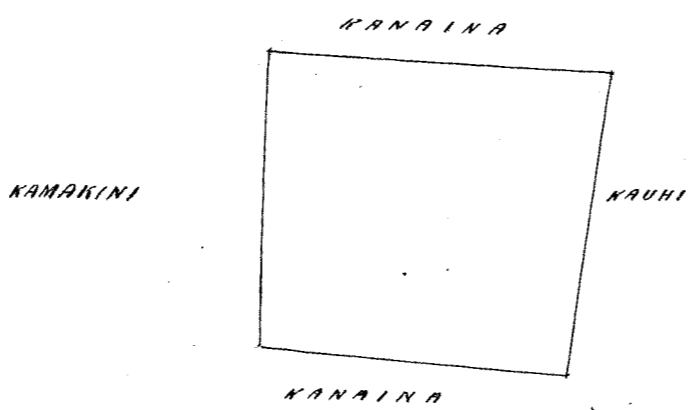
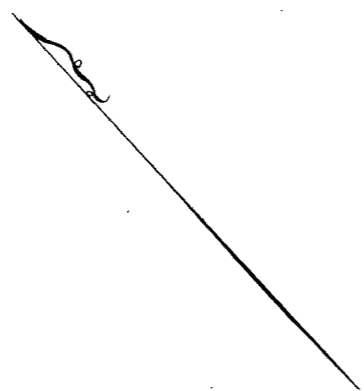

1 Kaulaha a Anika

Ulu Oia Kahina

Ua kei mai oia iho kona mau wahi ma Pūhūehūehi ma Lāhaina maika Moku o Maui; no ka mea, ua lona ia iho wahi ma Pūpūi mai i ka makahiki 1836, a ua mōho heahea oleia a hiki i keia mau wahi.

Oia ka maku a hōko nei no Kahina; he kūlewa hoi, kona malalo iho o ke Alo Alodi. Ana e ukū mai oia i ke ke Aupuni kapaka; alaila, ua kōpono ia ia ka palapala o ke Alo Alodi. Ione nāe ia ia ke ukū ma ka hōkōloko a me ka hōkōloko ana i ka olelo. Ione,

No ka auni a me ke pū ana i ka olelo ma ka Mūpepa \$ Hon.
 No ke kōpe ana i ka olelo hoiwa
 No ka palapala hoi

G. M. Robertson No ka hana ana i ka la 6 o Iune 1852.
 W. K. He No ke kōpe ana i ma olelo a ma hoiwa
 J. H. Kaulahao No ke auni ana i ka la No ka auni ana ana \$2.00
 J. H. Smith No ke kōpe ana
 No ka hōkōloko ana i ka olelo Novemabā, 1852.

\$ 9.00

Oia ma fulena. Aniani a W. P. Alexander

Kahina Ulu Oia. He kūlewa hoi ma ke Aupuni o Pūhūehūehi maika Aupuni o Lāhaina, Maui.

E hōmaka ana ma ke kōpe Akau Komohana, a e hōlo ana

Hema 52° Hikina	0.63	Hau. a pili ana ma ka Pali
Hema 19½ Komohana	0.67	" " " "
Akau 55° Hikina	0.66	" " " " Kahawai o Lāhaina
Akau 35° Hikina	1.90	" a i kela kapa o " "
Hema 32½ Hikina	0.96	" a pili ana ma ka fula
Akau 58½ Hikina	2.66	" " " "
Akau 33¼ Hikina	2.02	" " " "
Akau 44¾ Komohana	1.04	" " " " ke Akau
Hema 76¼ Komohana	2.19	" a hiki i kela kapa o Kahawai
Hema 61½ Komohana	4.30	" a pili ana ma ka Pali i ka kōpe i hōmaka ai.
Ka ili	Ekolu Roda	o Kawakolu ma maika Roda.

No ke ana ana Ulu \$2.00
 W.P.A.

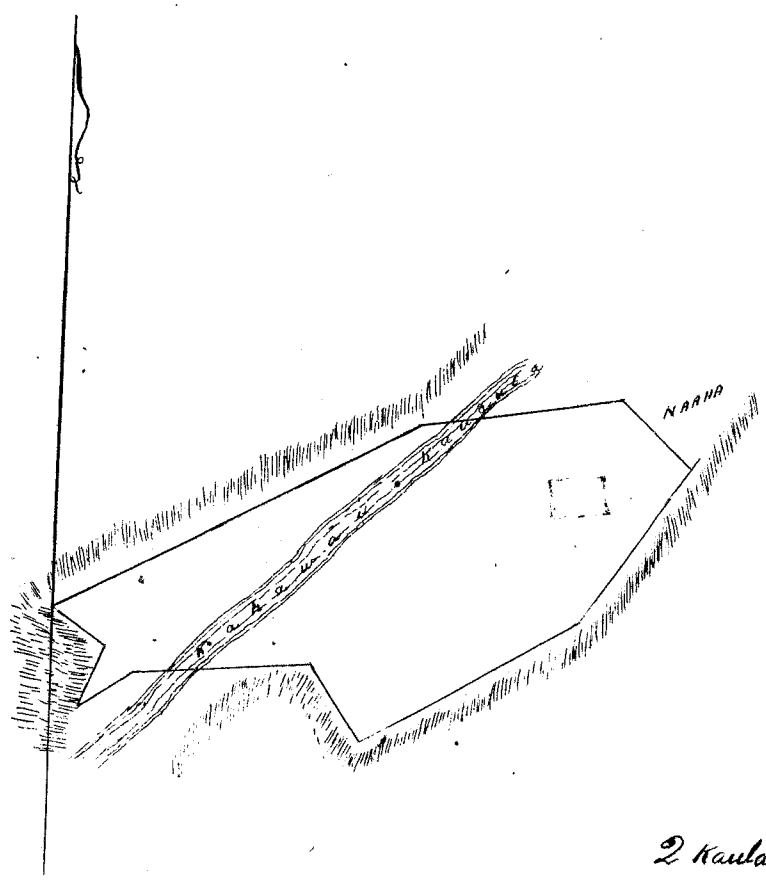

2 Kaulahao = 1 Iriha

Ua koi mai oia no kina mau wahi ma *Chikanaka* ma *Honolulu*, ma ka *Mokupuni* o *Oahu*; no ka mea, ua loaa ia ia hua mau wahi mo *A. Kae* muhi, muma ahu o ka makahiki 1839, a ua noho heaia oia i Chika matoru hoohe nei no *Papa*; he kuleana hoi kona matala iho i ke *Umo* *Ulelio*. Ima i utu mai oia i ke ke *Mokupuni* kapahi; a hila, ua kuyrono ia ia ka *Palapala* *Sila* *Ulelio*. Ima i utu Ima i utu ia ia ke iku me ka hoohe o kelo a me ka hoohe ana i ka olelo. *Pene*,

G. M. Robertson
W. Lee

J. Kaulahua
J. H. Smith

No ka puni a me ke pui ana i ka olelo ma ka *Mokupuni*.
No ke kope ana i ka olelo koina.
No ka palapala kii
No ka hana ana i ka la 20 o *Septemaba* 1850.
No ka kope ana i na olelo a nashoike 1/2 *Oca*.
No ke ana ana i ka la 28 o *October* 1852
No ke kope ana
No ke hoohe ana i ka olelo *Novemaba* 3, 1852.

Eia na palena. *Amia* i *J. P. Kaulahua*.

700

Huleana ma *Chikanaka*, *Honolulu*, *Oahu*

Apana 1. 5 *Loi* o *Kihua* holo. E hoomaka ma ke kiki *Hikina* o *Hua* *Apana* *Aina*, e pili ana me ka *Hikina* *Kamaka* a me ka *auwai* o *Kaulawela*, *Ue* holo *Akau* 49° 30' *Hem*. 7 1/2 *Pauku*. Pili ana me *Kamaka* a kiki i ke *Uapana* o *Ulelio* *Hema* 47° *Hem*. 68 *Pauku*, a me *neenee* *Lina* *Akau* 16 *Pauku*, kiki a me *Hema* 44° 15' *Hem*. 69 *Pauku*, a me *Hema* 53° 45' *Hem*. 1 3/4 *Pauku*. a me *Hema* 47° *Hem*. 75 *Pauku* a me *neenee* *Lina* *Hema* 6 *Pauku*, koke, a me *Hema* 47° *Hem*. 44 *Pauku* e pili ana me na *Loi* *Kaele* o *Kihua* *Uapana* a kiki i ke *Huleana* o *Kahakuhili*, *Ulelio* *Hema* 40° 30' *Hik*. 1 2/3 *Pauku*. a me *Hema* 37° *Hik*. 9 1/2 *Pauku*. ma *kuana* me ke *Kahakuhili* a kiki i ka *aina* i olelio no *Lahaina* *mauna*, *Ulelio* *ma* *aina* *Akau* 42° *Hik*. 54 *Pauku* *mauna* o ka *auwai* a kiki i *kuana*, a me *Akau* 24° *Hem*. 26 *Pauku*, a me *Akau* 53° *Hik*. 1 1/2 *Pauku*. a me *Hema* 55° *Hik*. 1 *Pauku*. a kiki i ka *auwai* me *Kaulawela*, *Ulelio* *Akau* 31° *Hik*. 1 1/2 *Pauku*. a me *Akau* 5° 30' *Hik*. 1 1/2 *Pauku*. ma ia *auwai* a kiki i ke kiki i *hoomaka*.

Ma *ia* *Apana* 1 1/2 *Eka*.

Apana 2. 1 *Loi*. E hoomaka ma ke kiki *Akau* o ka *aina* o *Chiaaku* me ka kiki *Hema* o ka *auwai*, *Ue* holo *Hema* 42° 30' *Hik*. 1 1/2 *Pauku*. ma ke *Chiaaku* a kiki i ke kiki *kokoke* i ke *Alani*, *Lilika*, *Ulelio* *Akau* 40° 30' *Hik*. 81 *Pauku* ma kahi *waiho* wale me ke *Alani* a kiki i ka *aina* i olelio no *Kaneakaku*, *Ulelio* *Akau* 50° *Hem*. 1 1/4 *Pauku*. ma ia *aina* a kiki i ka *auwai* e pili ana me *Kaulawela*. *Ulelio* *Hema* 15° 1/2 *Hem*. 6 *Pauku* ma ka kiki *Hema* o ia *auwai* a kiki i ke kiki i *hoomaka*.

Ma *ia* *Apana* 108 1/2 *Eka*. *Ma* *ia* *Kuleana* *apane* 1 2/3 *Eka*

J. P. Kaulahua

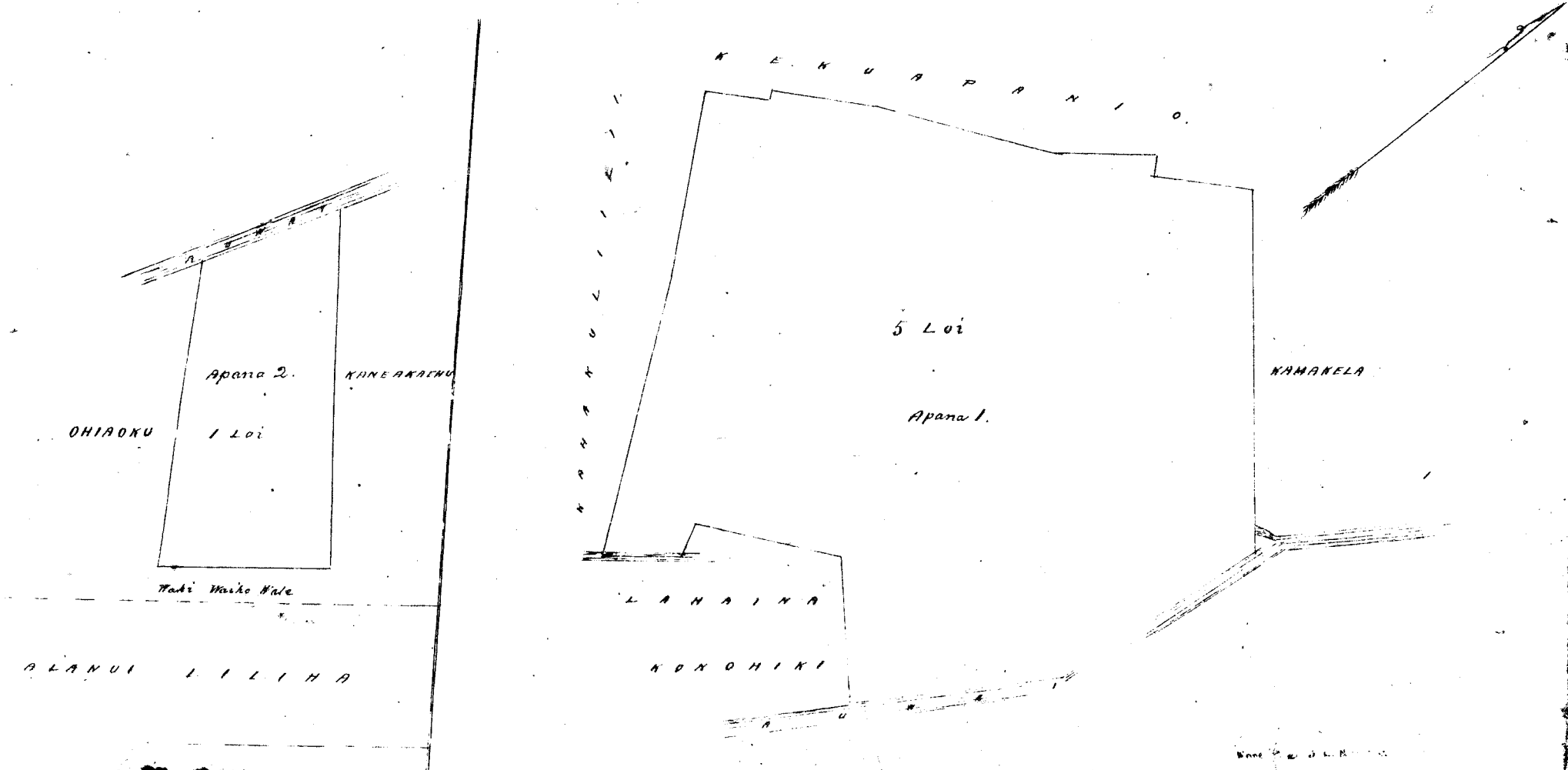

Hele 606 Kaupapa (no Kaou)

Ua hoi mai oia hu kono wahi, ma Hikihale, ma Honolulu, ma Kona, ma ka Moku o
 Oahu, ma ka mea, ua hooiaia keia wahi no Hikihale mai i ka wa o Kamehameha I mai, a
 ua noho oia ma keia wahi a hiki i kona make ana i ka makahiki 1846, hooi oia i keia wahi ia
 Kaou kama keiki, a ke noho mau nei nei oia ma keia wahi me ke keakea oia a hiki i keia
 manawa.

Oia ka mauka a hooi nei no Kaou a ia Kaou, he mauka he kono malalo oho o
 k. Ano Meleio. Ina e uku mau oia i ke ke aupuni hapaha, alaila, ma kupaoniaia ka Pala-
 pala Selo Meleio.

Ino naci iaia ke uku no ke hooi oho a me ke hooi ana i ka olelo. Penci.

G. W. Robertson

J. H. Smith

J. Kekaulahe

W. A. M.

No ka wahi a me ke paia ana i ka olelo ma ka Meleio

No ke kope ana i ka olelo kama

No ka palapala hii

No ka hana ana i ka la 3 o Novemaba 1852.

No ke kope ana i ka olelo a ma hiki 1/3 o au

No ka ana ana i ka la 5 o Novemaba 1852. Ukuia ke mea \$2.50

No ke kope ana

No ka hooi ana i ka olelo Novemaba 16, 1852.

\$ Ten

Eia na palena.

Anaia e J. H. Kalamia

\$ 4 00

Pahale ma Honolulu, Oahu.

He mauka ma ke kahi o ka Pahale, ma ka lili o Muliwai
 a me ke kahi o Kikina o ka Loko lili i oleloia no Kapua, e pili ana me ke kahi o ka pa o
 Keomaitani, a hiki i ke kahi o A e holo Heema 27° Hik. 59 1/2 Kapua e pili ana me ka pa o
 Keomaitani a hiki i ke kahi e pili ana me ka pa o Kawewela, Alaila Heema 69° 15' Kom. 46 1/2
 Kapua, a me Heema 44° Kom. 7 1/2 Kapua, a me Heema 60° Kom. 6 1/2 Kapua, e pili ana ia mau
 au me ka pa o Kawewela a hiki i ka pahale ma ke kahi o ka Hele a me ke kahi Heema o ke Ala lili,
 kekahi i ka Loko. Alaila Heema 35° Kom. 26 1/2 Kapua, a me Heema 39° 15' Hik. 22 1/2 Kapua,
 a me Heema 47° Hik. 40 1/2 Kapua ma ka Loko o Kapua a hiki i kahi i mauka i.

Ma ia Pahale

27 Arama 28 Kapua.

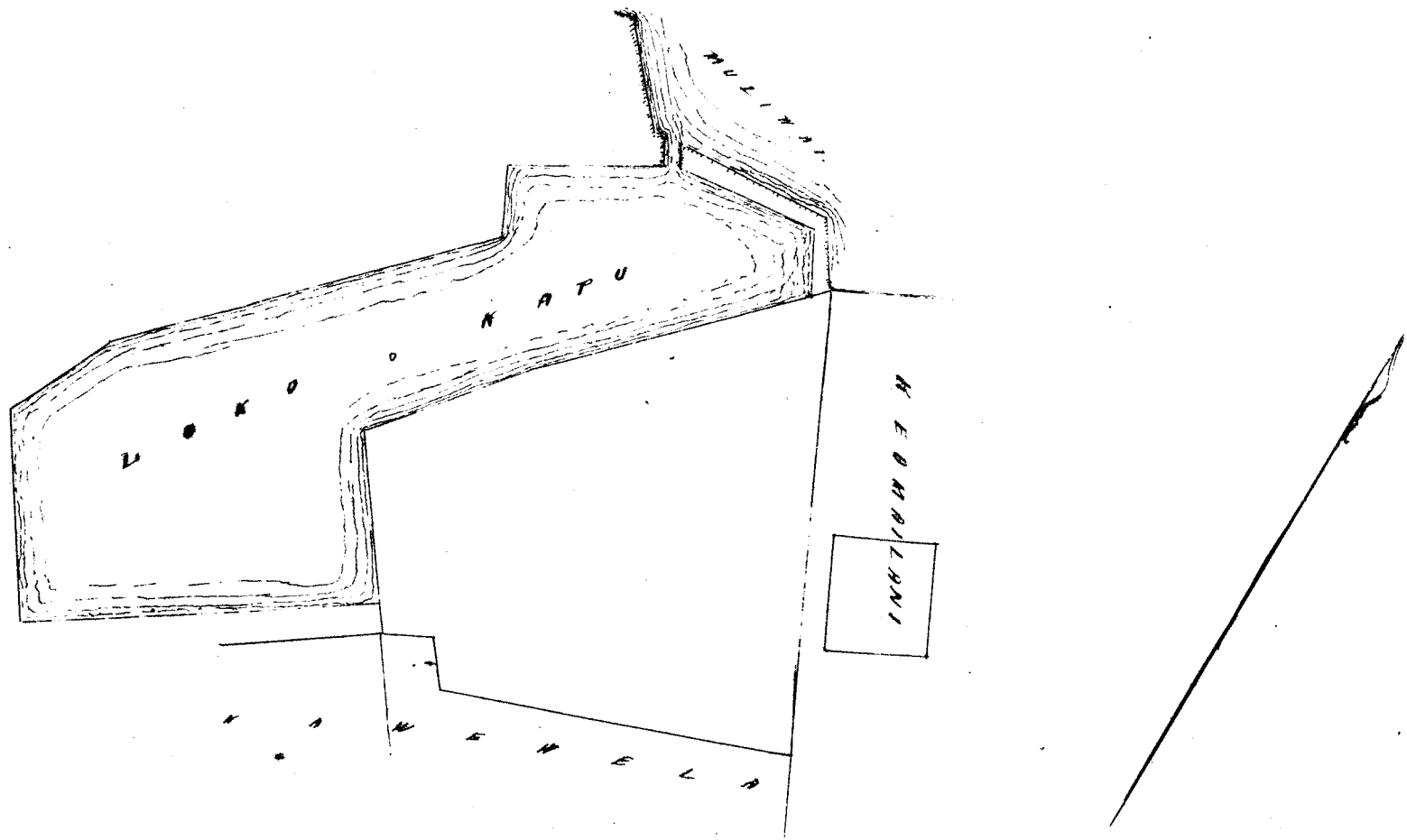

3 INCH SCALE

Ua kwi mai oia na kona wahi ma Kiiakumu i Aata ma Honolulu i kona, ma ka Mokupuni Oahu; no ka mea, ua loaa ia ia keia wahi no Kiiakumu mai, oia ka manawa i ka wahi ana o Kiiakumu i Kiiakumu no Oahu nei, a ua poho keakea oleia a hiki i keia manawa.

Oia ka makuu o hoko nei no Uluwa; ke kuleana hoi kona malalo iho o ke Ano Aloha.

Ina e ukui mai oia i ke ke Kupuni hapa ha; alaila; ua kupuni ia ia ka Palapala Pila Aloha.

Pono nae ia ia ke ukui no ka hoko o hoko a mu ka hoko ana i ka olelo. Penei; -

§ Ken.

G. M. Robertson

J. H. Smith

A. Kekaulahao

W. H. Lee

No ka kupuni a me ke paia ana i ka olelo ma ka Muepa.

No ke kope ana i ka olelo koina

No ka palapala kii

No ka hana ana i ka la 9 o Iune 1848.

No ke kope ana i na olelo a ma hoi ke 1/2 Awar

No ke ana ana i ka la 8 o Novemaba 1852.

No ke kope ana

No ka hoko ana i ka olelo Novemaba 26, 1852.

Oia na palapala. Ina e J. H. Kalama.

§ 5.12

Kuleana ma Aata, Honolulu, Oahu.

Loi. E hoomaka ma ke kiihi Kiiakumu o keia Loi, ma ka kiihi makai o ke Alanui Alii a me ke Ala Hakalili, a e holo Kema 17 Kom. 1/100 Kaulahao ma ka kiihi Akau o ka auwai o Kiiakumu i pili ana me ka hoi waiko wale o ke Alanui a me ke Loi a hiki i ka fohaku; - Alaila Akau 61° 30' Kom. 1/100 Kaulahao, a me Akau 45° 15' Kom. 1/4 Kaulahao ma Kiiakumu o keia me ke Loi a hiki i ka olelo o Kiiakumu i pili ana me Kiiakumu; - Alaila Akau 33° Kik. 98 Puku, a me Akau 52° Kiiakumu 1 Kaulahao ma Kiiakumu no Kiiakumu a hiki i ka kiihi makai o ke Alanui; - Alaila Kema 51° Kik. 61 Puku, a me Kema 32° Kiiakumu 1/100 Kaulahao ma ka kiihi makai o ke Alanui Alii a hiki i ka kiihi i hoomaka i.

44/100 Eka.

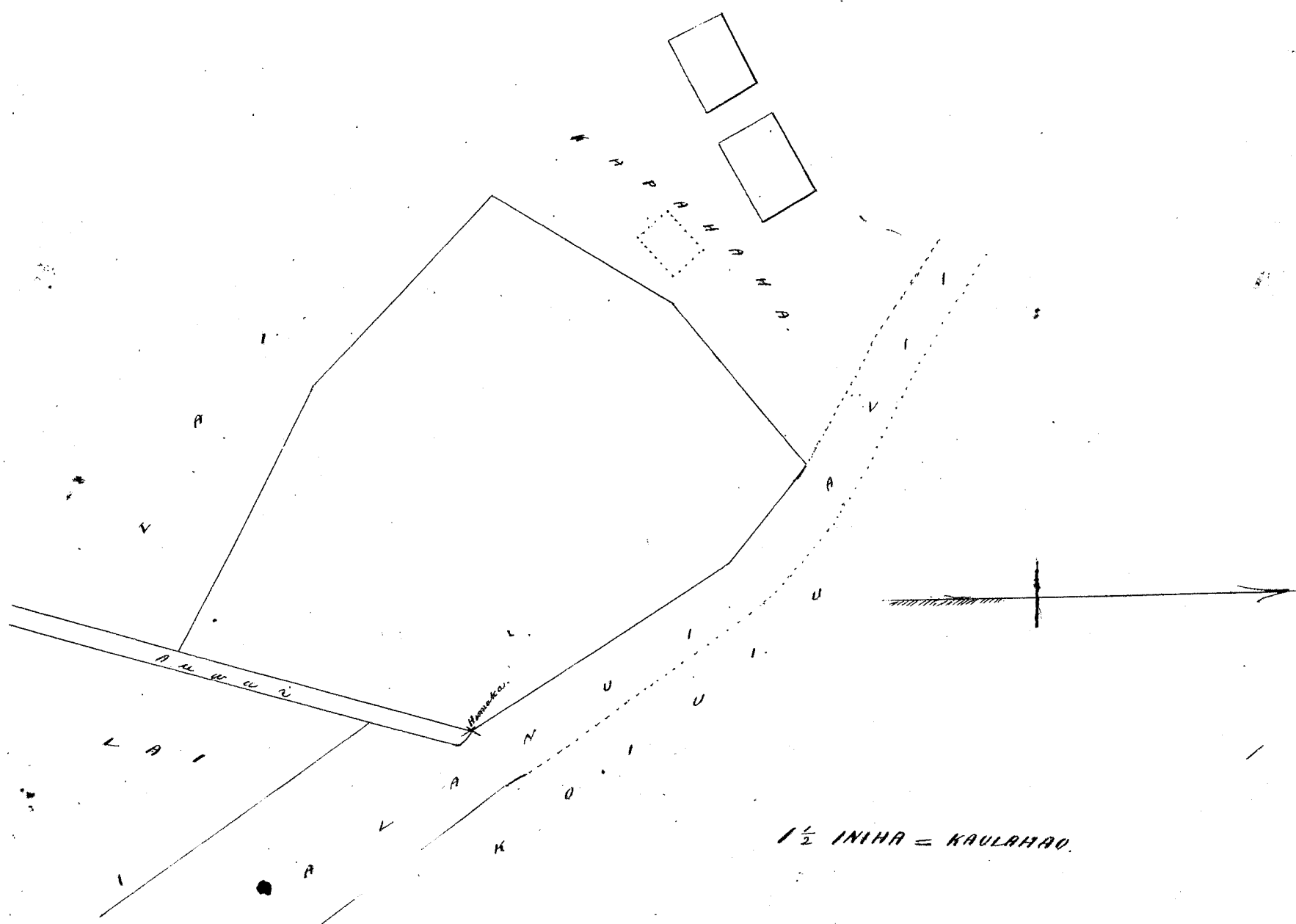

1/2 INIHA = KAULAAO.

Helu 285 I. Kamakini
Māi Noa 1241 V.2. māi.

Ua kōi māi oia i kōna wahi ma Panaua ma Lahaina, ma ka Mokupuni o Maui;
no ka mea, ua loaa ia ia keia wahi no Hekeamōhī māi, a ua noho keakea oia a hiki i keia
manawa.

Oia ka makou e hooko nei no I. Kamakini; he kuleana hoi kōna malalo iho o
ke Aho Alodio. Ima e ukui māi oia iho ke Aupuni kapaha; alaila, ua kupono ia ia ka Pala-
pala Iho Alodio.

Pono nae ia ia ke ukui no ka hooko kōkō a me ka hooko ana i ka olelo. Penei,

G. M. Robertson

J. H. Smith

J. Hekeamohi

W. M. Ke

No ka umu a me ke pui ana i ka olelo ma ka Nupoua

No ke kope ana i ka olelo kōna, 1 Oaao

No ka palapala kii

No ka hana ana i ka la 26 o Dekemaba 1846.

No ke kope ana i na olelo a me hoi ke, 4 Oaao

No ke ana ana i ka la

No ke kope ana

No ka hooko ana i ka olelo Novemaba 26, 1852.

\$ Ten.

Oia na palena.

Amāia e W. P. Alexander

\$ 11.50

Ka faamii o Kamakini ma Panaua i Lahaina, Maui.

E hormaka ana ma ke kahi Kema Komohana ma ka aao ma ka o ke Alanui e
heli ai i ka Halepule o na Hale, E pili pu ana hoi me ka loimui o Hanaina, a e holo ana

Akau	43 1/2	Hikina	11.28	Kauli	e pili pu ana me Hanaina
Akau	43 3/4	Komohana	3.60	"	"
Akau	41	Komohana	1.71	"	"
Kema	86°	Komohana	1.06	"	"
Kema	36 1/2	Komohana	6.58	"	"
Kema	39 1/2	Hikina	2.54	"	"
Kema	43 1/4	Komohana	3.50	"	"
Kema	34 1/2	Hikina	3.15	"	"

a hiki i ka hoi i hormaka ai.

Ka Ii

Elima mau Eka a me ka hapalua.

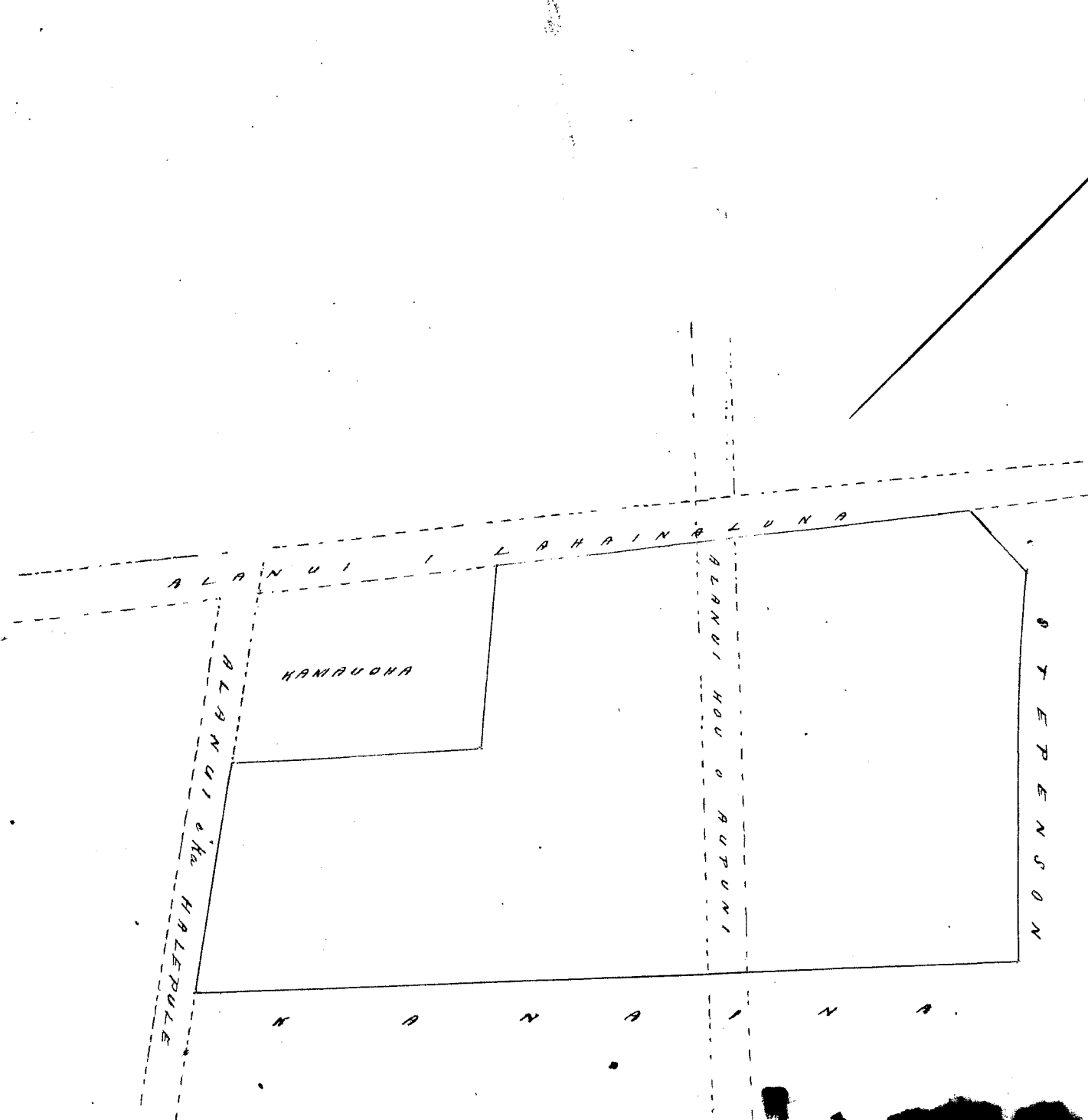

Heleu 278 B Hinaw

Mai Awa 4 Vol. II. mai.

Ua koi mai oia no kona wahi ma Polani i Lahaina, ma ka Mokupuni o Maui; no ka mea, ua loa ia ia keia wahi no ke Alii mai (Kamehameha III.) a ua noho keakea oleia a hiki i keia manawa. Oia ka maku e ho'oko mai no Hinaw, ke kuleana hoi kono malalo iho o ke Alii di. Ana e utu mai oia i ke ke Ahupuni hapaha; - alaila, ua kōpuna ia ia ka Palapala Ika Olo. Pono nae ia ia ke utu no ka hō'oholo a me ka hō'oholo ana i ke olelo. Penei

Ken.

No ka omi a me ke pua' ana i ke olelo ma ka Nupupa.

No ke kope ana i ke olelo kōma.

No ka palapala kii

G. M. Robertson

No ka hana ana i ka la

J. H. Smith

No ke kope ana i na olelo a ma hiki

J. Kekaulakao

No ke ana ana i ka la 12 Novemaba 1852.

W. Hee

No ke kope ana

No ke hō'oholo ana i ke olelo Novemaba 27, 1852.

Amoa # 7 00

Oia na palena.

Anuia i M. P. Alexander

Ke pahale kuleana kōma e waiho ana ma ke Ahupuni o Polani i Lahaina Maui. Penei kōma mau palena, - E hōmaka ana ma ke hiki Kōma Kikina o keia pal' kahi i pili ai oia me ka pahale o John White a me ke Alanui Ahupuni, a e holo ana

Mau 47° 40'	Kōmohana	2	Kaulakao	5	4	Kōpuna e pili ana me ke Alanui	
Kōma 43'	Kōmohana	1	"	"	22 1/2	"	Kaluaokamano
Kōma 49 1/2'	Kikina	1	"	"	18 1/2	"	Kakakai
Mau 60 1/4'	Kikina	1	"	"	29	"	John White

a hiki aku i kahi i hōmaka ai.

Ka Alii Kanakoholukūmānua Roda.

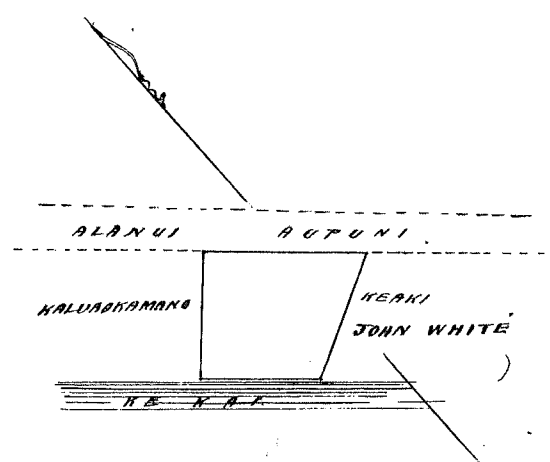

2 chains = one inch.

Olelo hō'oholo. Ua hō'oko mau ia keia kuleana i Hinaw, aha, ua kōma pua' kahi o Keaki (John White) iloko oia hō'oko ana; nolaila, ua kōi mai oia no kona wahi i kōma iloko oia hō'oko ana i Hinaw, a i ka hana ana, ua ma'opopo no ua wahi ka i kōma ai, no John White, nolaila, ua okiia a hana kōma i M. P. Alexander ma ke kōma ana a na Lina Kōma, a ua hō'oholo e like me ia maluna, a ua pōkai keia maluna.

Novemaba 27, 1852.

A. L. Kūliiti
Kakawolelo o na Imaka

Helu 27 B Kalaipaihala

Mai Oloa 37 Vol. 2. mai.

Ua hoi mai oia no kona wahi ma Polaiiki i Lahaia, ma ka Moku o Maui; ma ka mau, ua lona ia ia keia wahi no Ulu mehehe mai i ka makahiki 1839, a ua noho keakea oleia a hiki i keia manawa.

Oia ka makou e hooke nei no Kalaipaihala; he kuleana hoi kona malalo iho o ke Awa Oloa. Ana e nuku mai oia i loko ke Aupuni hapaha; alaila, ua kuleana ia ia ke Palapala Sila Oloa.

Jonu mai ia ia ke nuku no ke hooke oloa a me ka hooke ana i ka olelo; Penei, -

- No ka rumi a me ke paia ana i ka olelo ma ka Moku o Maui
 - No ke kope ana i ka olelo koma
 - No ka palapala kii
 - No ka hana ana i ka lani 19 o Aperila 1849
 - No ke kope ana i ma olelo a ma hoi ke 1/2 Awa.
 - No ke ana ana i ka lani
 - No ke kope ana
 - No ka hooke ana i ka olelo, Novemaba 27, 1852.
- G. M. Robertson*
J. H. Smith
J. Kekaulaha
W. Ke
- Eia ma palena: *Anna* o *W. P. Alexander*
- \$ 4.00

Aia kona kuleana a waito la ma ke Aupuni o Polaiiki i Lahaia, ma Maui. Eia ma palena: E hooke ana ma ke kii i ka lani, ka kii e pili ai keia me ke John White a me ke Alanui Aupuni, a e hooke ana

Alanui	47 1/2	Hikina	0. 41	Staut. e pili ana me ke Alanui
Alanui	47 3/4	Komohana	1. 67	" " ke pahale o Oleloa
Alanui	42 1/4	Komohana	0. 55 1/2	" " ke Kakaikai
Alanui	53 1/4	Hikina	1. 63 1/2	" " John White

a hiki aku i ka hoi i hooke ai. Ka Ali Umikumama lua mai Rodu (12)

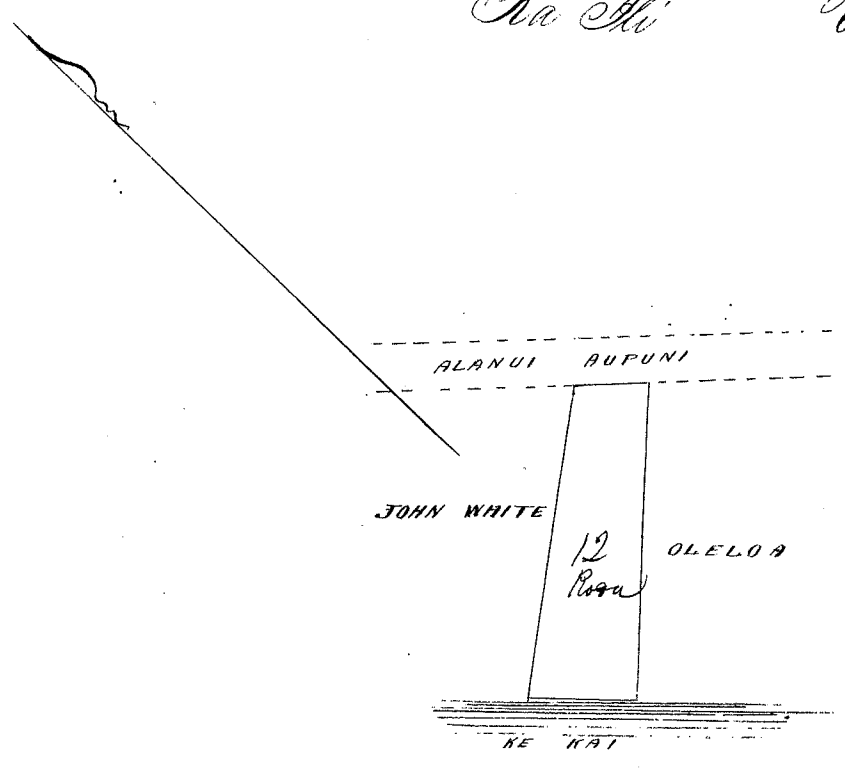

1 Chain = One Inch.

Oleloakaka - Ua hooke ma ka keia kuleana o Kalaipaihala ma ka lani 10 o Aperila 1849, aia, ua hooke ma ka hooke o ka pa o John White i loko oia hooke ana, (alaila, ua hooke hooke a waheia ke John White wahi ma loko a e oia hooke ana, a ua hooke kona, ana hooke ke Kalaipaihala e W. P. Alexander, oia keia i hooke ma lona, a ua hooke keia ma lona.

Novemaba 27, 1852. *A. P. Naititi*
Kakaula o ma Puna H. H. A.

Mai Awa 14 Vol. 9, mai.

Ua koi mai oia no kona mau wahi ma Punahele & Nipuaa ma Paehi i Lahauna, ma ka Moku o Manu; no ka mea, ua loaa iaia keia mau wahi no

Oia ka makou e hooke nei no Hauola; he kulaana hoi kona matalo iho o ke Ano Alodiu. Ima e uku mai oia i ho ke Aupuni hapaha; alaila, ua kupo ia ia ke Palapala Lila Alodiu.

Pono naia ia ke uku no ka hooloholo a me ka hooloholo ana i ka olelo. I nei.

Nana Awa 14 Vol. 9.

Kulu 4878 Olatu

Ua koi mai oia no kona mau wahi ma Puhuehuiki & Nipuaa ma Lahauna, ma ka Moku o Manu; no ka mea, ua loaa iaia keia mau wahi no

Oia ka makou e hooke nei no Olatu; he kulaana hoi kona matalo iho o ke Ano Alodiu. Ima e uku mai oia i ho ke Aupuni hapaha; alaila, ua kupo ia ia ke Palapala Lila Alodiu.

Pono naia ia ke uku no ka hooloholo a me ka hooloholo ana i ka olelo. I nei

- No ka rumi a me ke fua ana i ka olelo ma ka Muepa
- No ke kope ana i ka olelo koina
- No ka palapala kii
- No ka hana ana i ka
- No ke kope ana i na olelo a ma hooke
- No ke ana ana i ka la Uku i ke ana ana. \$3.50.
- No ke kope ana
- No ka hooloholo ana i ka olelo. Novemaba 30, 1852.

Oia ma palena. Anau e L. J. Ma.

\$ 8.00

Ke ana ana i ke Kuleana o Olatu ma ke Nipuaa "Puhuehuiki" a me "Nipuaa 2" ma Lahauna, Manu; ma ka Moku o Manu, a e holo ana

Maui	30'	Komohana	1, 33	Kaulahao	pili ana ia	I
Maui	14 1/2'	Komohana	5, 30	"	"	"
Hema	49'	Komohana	4, 10	"	"	Auwa
Hema	43 1/2'	Komohana	0, 57	"	"	"
Hema	40 1/2'	Hikina	3, 06	"	"	Kaana
Maui	44'	Hikina	1, 47	"	"	paalima
Hema	37'	Hikina	1, 20	"	"	"
Maui	61'	Hikina	0, 26	"	"	"
Hema	37'	Hikina	1, 27	"	"	"
Hema	50'	Komohana	1, 86	"	"	"
Hema	32'	Hikina	1, 56	"	"	Kaana
Maui	80 1/2'	Hikina	0, 57	"	"	"
Maui	27 1/2'	Hikina	2, 15	"	"	Manu

a hiki i ka hoi i hoomaka ai. Oka ili o keia ana 1 Eka, 2 Puda, 30 Puda.

Apana 2. Ima kulo ma ka fua, me ka kula ma Puhuehuiki i Nipuaa. O hoomaka ma ke kiki Maui Hikina o keia ana ma ka hoi i pili ai ia Namaka me ka Auwa, a e holo ana

Hema	21'	Hikina	2, 05	Kaulahao	pili ana ia	Namaka
Hema	62 1/4'	Komohana	3, 95	"	"	Komohiki
Hema	73 1/4'	Komohana	2, 74	"	"	"
Maui	35'	Komohana	4, 23	"	"	"

(Nana ma)

Mau	45 1/2	Hikina	5.70	Kaulavao pili ana ia Hinia
Hema	39 1/2	Hikina	3.80	" " "
Mau	83	Hikina	1.73	" " "

a hiki i kahi i hoomaka ai. Oka ili o keia " 3 Eka, 1 Ruda, 14 Ruda.

Apana 3. Na Mo Anu Makai. E hoomaka make kahi Hema o keia make kahi i pili ai ia Poo-puu laua me Naai, a e holo ana

Mau	63	Hikina	3.67	Kaulavao pili me Naai
Mau	13	Komohana	0.54	" " " " " " " " " " " "
Mau	34 1/4	Hikina	0.73	" " " " " " " " " " " "
Mau	5 1/2	Komohana	0.57	" " " " " " " " " " " "
Hema	61 3/4	Komohana	4.83	" " " " " " " " " " " "
Hema	34 1/4	Hikina	1.28	" " " " " " " " " " " "

a hiki i kahi i hoomaka ai. Oka ili o keia ana " 2 Ruda 7 Ruda.

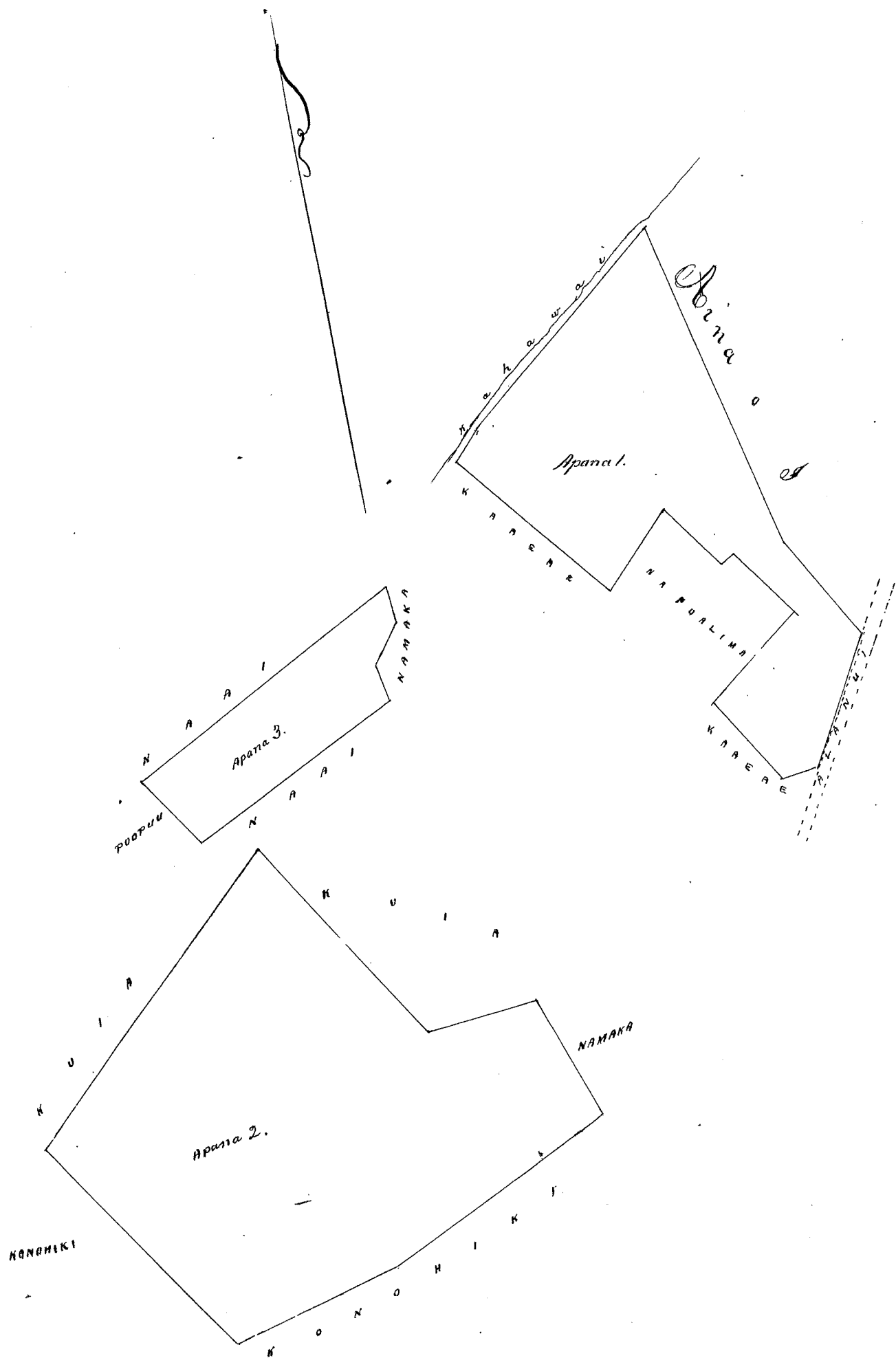

2 Chains to an Inch.

See No 477^d

Ua koi mai oia no kona mau wahi ma Kahiamae o Moamui i Taharua, ma ke Aupuni o Maui; no ka mea, ua loa ia ia keia mau wahi no kona mau makuu mau ka pahala i ka wa o Kamohamohai, a no Kapole mai wa Apama ma Kahiamae, a ua noho keakea oia i hiki i keia maua.

Oia ka makuu e hoko nei no Kahiamae; he kuleana hoi kona ma lalo iho o ke Aho Alodii. Aua e uku mai oia i ke Aupuni hapaikai; aiaia, ua kupo ia ia ka Palapala Ika Alodii.

Pou mai ia ia ke uku no ka hoko kolo a me ka hoko ana i ka olelo. I nei;

- No ka rumi a me ke paai ana i ka olelo ana ka Nupapa
- No ke kope ana i ka olelo koina
- No ka palapala kii
- No ka hana ana i ka la
- No ke kope ana i na olelo a na hoiho
- No ke ana ana i ka la Ukuu ke ana ana \$2.50.
- No ke kope ana
- No ka hoko ana i ka olelo Novemaba 30, 1852.

G. M. Robertson
 J. H. Smith
 J. Steadman
 W. Lee

Eia na palena. Aiaia o L. S. Uu.

\$ 5.00

Ke ana ana i ke Kuleana o Kahiamae ma ke Aupuni o "Kahiamae" a me "Moamui" ma Taharua Maui Apama. Ke mo Kuleana ma "Kahiamae." E hoomaka ma ke hiki oia o keia ma kahi i pili ai i ke Aupuni Aupuni a me ke Nonohiki a holo ana

Akau 38 1/2	Komohana	1.54	Kaulahao e pili ana i ke Aupuni Aupuni
Akau 46 3/4	Hikina	1.88	ko Apama
Hema 9	Hikina	0.56	" Kupuokopoko
Hema 40 1/2	Komohana	1.46	" Nonohiki
a hiki i kahi i hoomaka ai.			Oka ili 25 Roda

Apama 2. Pahu Aia Kalo ma Kahiamae. E hoomaka ana ma kahi i pili ai ia Aupuni a me ka pali, a e holo ana

Akau 56	Hikina	1.74	Kaulahao e pili ana i ka pali
Akau 33 1/4	Komohana	0.38	" " pailima
Akau 52	Hikina	0.36	" " "
Akau 39 1/2	Komohana	0.31	" " ko Anoaie
Hema 41 1/4	Komohana	1.53	" " Keopuni
Hema 53	Komohana	0.67	" " "
Hema 47 1/2	Hikina	0.34	" " "
a hiki i kahi i hoomaka ai.			Oka ili 14 Roda

Apama 3. Pahala ma "Moamui." E hoomaka ma ke hiki oia o keia ma kahi i pili ai i Kapule a me ke Aupuni Aupuni, a e holo ana

Akau 43 1/4	Komohana	0.77	Kaulahao ma ke Aupuni Aupuni
Hema 55	Komohana	1.52	" " ko J. H. Kahiamae
Hema 55	Hikina	0.90	" " Kahiamae kai
Akau 51 1/2	Hikina	1.32	" " Kapule
a hiki i kahi i hoomaka ai.			Oka ili 18 Roda

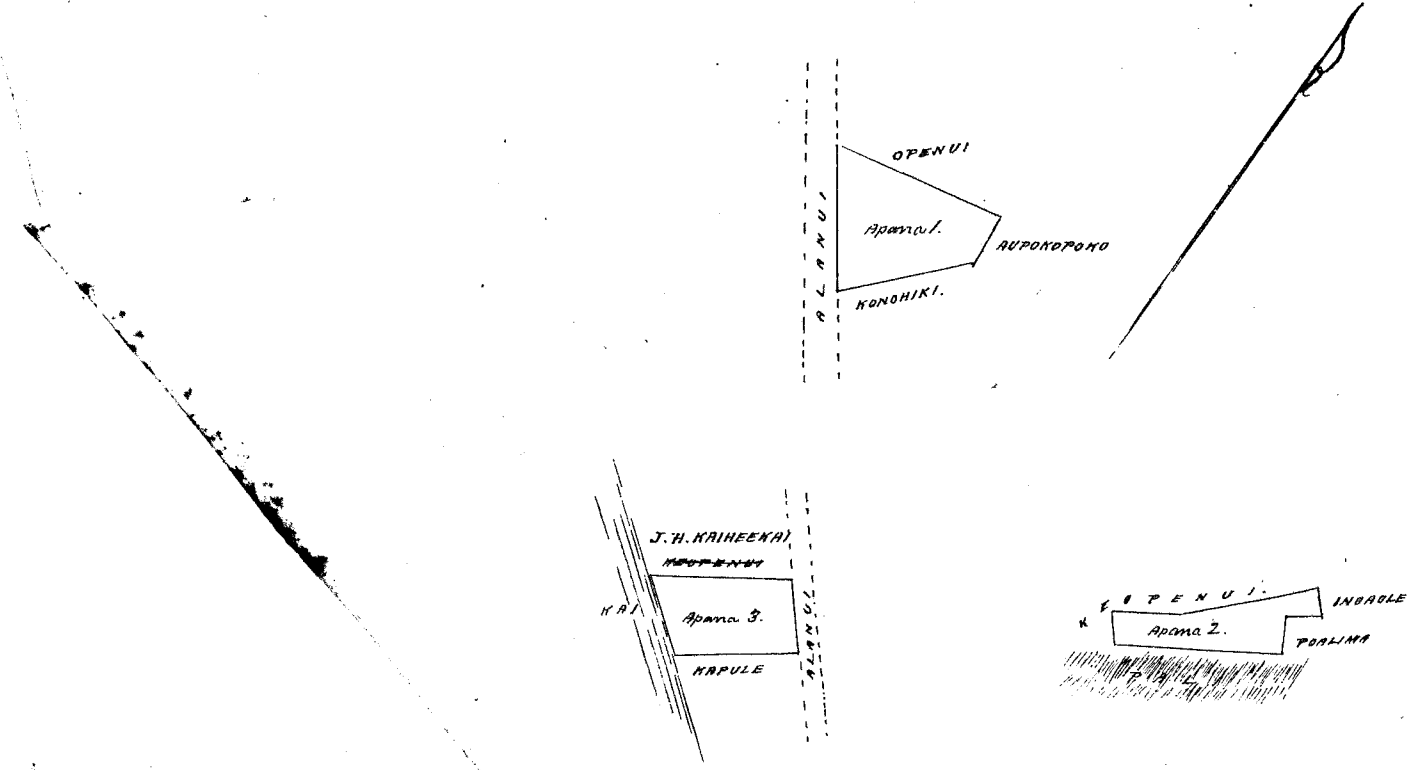

Scale 2 Chains to an Inch.

Heu 315 Pahia no Huakamauna

Ua koi mai oia me kona wahi ma Naniwai ma Lakaia, ma ka Moku o Maui; no ka mea, ua loa ia ia keia wahi no

Oia ka makou e hooke nei no Pahia aia Huakamauna; ke kuleana hoi kona mabalo iho o ke Am Alodio. Ima e ukou mai oia i ke ke Nupuni hupaha; aiaia, ua kupoia ia ia ka Palapala, Heu Alodio.

Iono mauia ia ke ukou me ka hookele-kolo a me ka hookele-ama i ka olelo. Ima,

No ka rumi a me ke paia ana i ka olelo ma ka Nupuni \$ Heu.

No ke kope ana i ka olelo koina,

No ka palapala kii

G. M. Robertson

No ka mana ana i ka la

J. G. Smith

No ke kope ana i ma olelo a ma hoi

J. Kekaulahas

No ke ana ana i ka la

Ukua ke ana ana \$2.00

W. H. H.

No ke kope ana

No ka hookele-ama i ka olelo Novemba 30, 1852.

Eia ma palena.

Anaia e W. P. Alexander

\$ 4.00

He palapala hookele i ke ana ana i ke kahi Kuleana Pahia o Pahia (no Huakamauna) Heu 315 e waiho ana ma ke Moku o Naniwai ma Lakaia, Maui.

E hookele ana ma ke kahi Akau Kikina o keia, a i hookele ana

Heu 48 1/2 Kikina 1,66 Kaulaha e pili ana me ke Alanui Duhini

Heu 44 Homokana 1,24 " " kupa o Heu

Akau 41 1/4 Homokana 1,62 " " " Hamakua

Akau 41 1/4 Kikina 1,02 " " " Baldwin

a kahi i kahi i hookele ai.

Ma Hei Awakalua Kumamaina Roda.

Celehoakaka

O keia ana ana maluna nei a W. P. Alexander, ua hookele hooia, aia ka pua o ke ana a

W. H. H. ma ka Awa 312 o keia Buhe

J. G. Smith
Ma ka Kaulaha

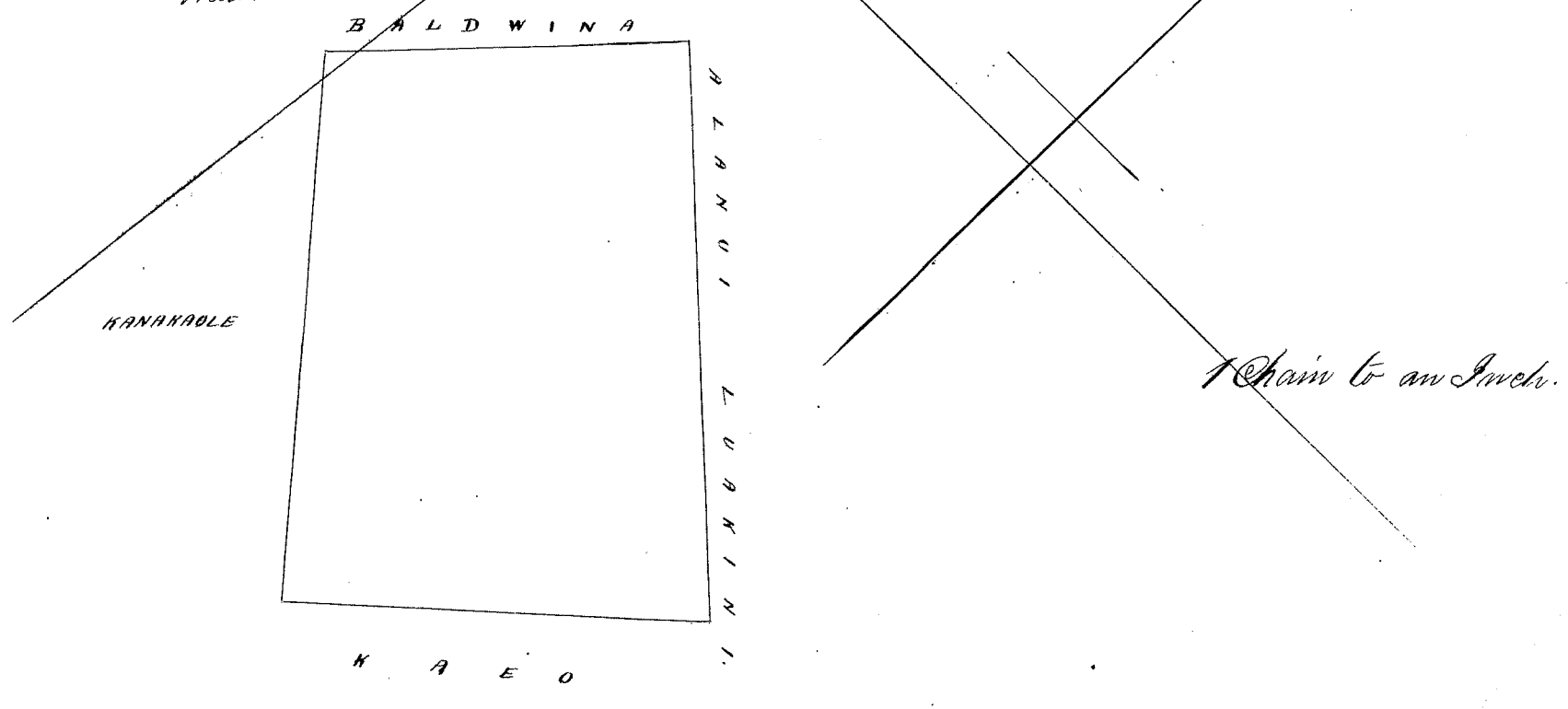

Ua kōi mai oia no kona mau wahi ma Hanakoa ma Lahaina Moku-puni Maui
 ua loa ia ia keia mau wahi i ka wa. Kamuhameha I. Awa noho keakea o ia a hiki i
 keia manawa.

Oia ka makou a hōke nei no Pūpuka; he kuleana hōi kona onalalo iho e ke ono alodio
 Ina e ulu mai oia i ke ke Aupuni hapahā; a hāia, ua kupo ia ia ka Palapala Sila
 Alodio.

Pono nāe ia ia ke ulu no ka hōkōlōkō a me ka hōhōle ana i ka olelo, Penei,

- G. M. Robertson
 J. H. Smith
 J. Steadman
 W. L. Hew
- No ka rumi a me ke pāi ana iwa olelo ma ka Kūpupa,
 No ke kōpe ana i ka olelo kōina
 No ka palapala kii
 No ka hana ana i ka la, 14 o Iune 1849.
 No ke kōpe ana iwa olelo a ma hōike
 No ke ana ana i ka la, 4 Māhiki 1852 Ua kōa ke ana.
 No ke kōpe ana.
 No ka hōhōle ana i ka olelo 2 Iuli 1852

Cia ma palama. Ana ia e L. S. Ua.

5 00

Ke ana ana i kekahi mau apana aia, Pūpuka, ma ke Ahupuaa Hanakoa ma
 Lahaina Maui. E kōlu mau apana.

Apana 1. Iwi hōkōhōi a me kula, E hōmaka ana ma kahi i pili ai ia Hanakoa,
 a me ka auwai, a hōle aku.

Akau,	44 1/2°	Komohana,	2.17	Kaulahas ma ke Hanakoa,
Hema,	48°	Komohana,	0.75	"
Akau,	52 1/2°	Komohana,	0.98	"
Hema,	40 1/4°	Komohana,	1.64	Kapahā,
Hema,	44°	Hikina,	0.73	S. Ua.
Hema,	22 3/4°	Komohana,	1.02	"
Hema,	65°	Hikina,	0.36	J. H. Kāihukāi,
Akau,	29°	Hikina,	1.12	"
Akau,	46 1/2°	Hikina,	1.21	"
Hema,	49 1/2°	Hikina,	0.90	"
Akau,	52 1/4°	Hikina,	0.92	Auwai,

a hiki i kahi i hōmaka ai, ka ili, 1 Ruda, 20 Ruda.

Apana 2. Mau ma kula, E hōmaka ana ma kahi i pili ai ia J. H. Kāihukāi;
 lāwa me S. Ua, a hōle aku.

Hema,	49°	Komohana	1.96	Kaulahas ma ke J. H. Kāihukāi
Hema,	43 1/2°	Komohana	4.03	" Hanakoa,
Akau,	68 1/2°	Komohana	0.97	" Hanakoa,
Akau,	48°	Hikina	3.23	" Poalima
Akau,	22	Komohana	0.52	"
Akau,	48	Hikina	2.82	" Ahu,
Hema,	43°	Hikina	1.12	S. Ua.

a hiki i kahi i hōmaka ai, ka ili, 2 Ruda, 11 Ruda.

Apana 3. Pūku aia kahi, i ulu i Kāihukāi, E hōmaka ana
 kahi, i pili ai ia J. H. Kāihukāi, me Kāihukāi, a e hōle ana,

Akau,	48 3/4°	Hikina,	0.95	Kaulahas ma J. H. Kāihukāi,
Akau,	28 1/2°	Komohana,	0.40	"
Akau,	80°	Hikina,	1.06	"
Hema,	9°	Hikina,	0.46	"
Hema,	67°	Komohana	1.82	" Kāihukāi,

R
 1.20
 2 11
 11
 100.02

a hiki i kahi i hoomaka'i. Ma ili 11 Roda.

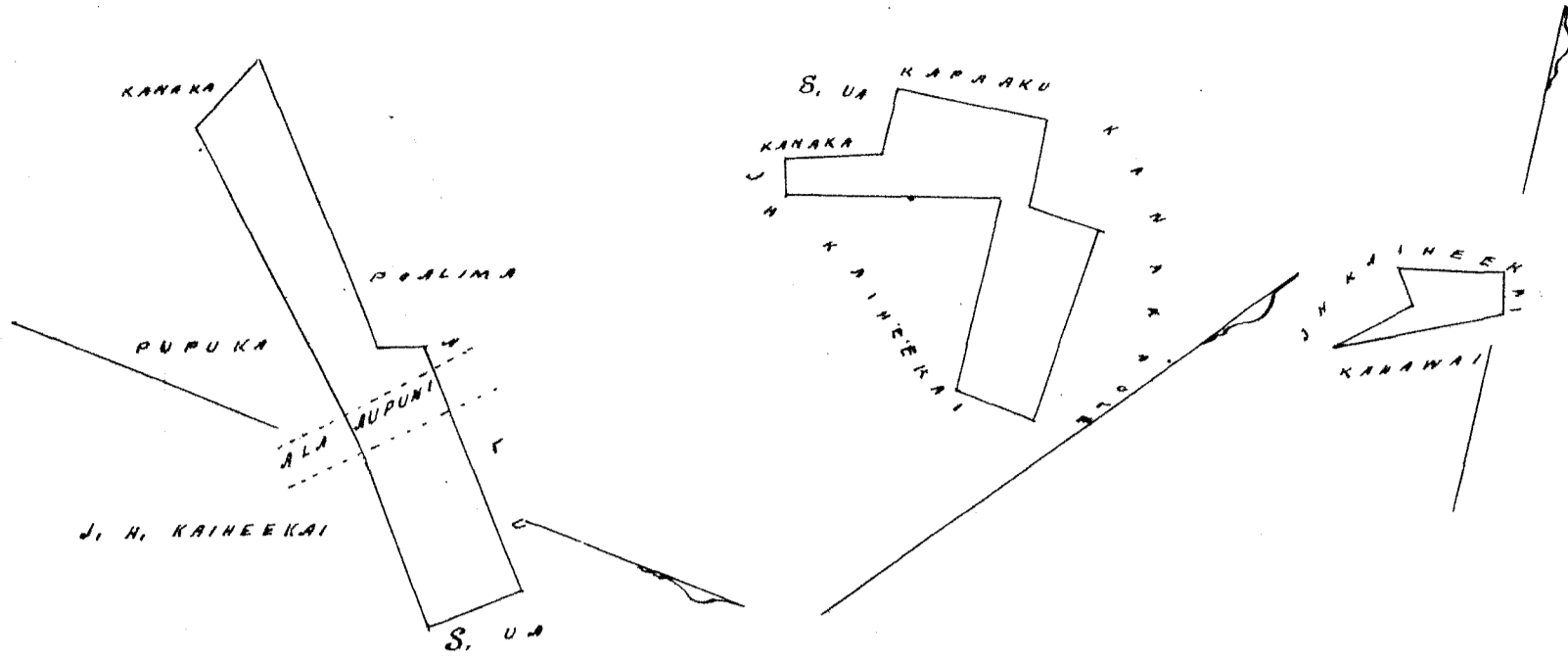

Helu 4878 B. Kapua. (1852)

Ua hoi mai via no kona wahi, ma Pahua ma Lahaina ma ka Mo'ohi-
puni. Ma aui, ua loa ia ia keia wahi mai ka manawa kati ko mai, mawua
aku o ka noho ana o Mawa malai'a, a ua noho keakea oleia a hiki i keia manawa.

Oia ka matou e hoo'u nei no Kapua, he kuleana hoi kona malalo iho o
ke ano Alodio, ina e wai mai via i ke ke Ahupuni hapaha, alaila ua kupaia ia
ia ka Palapala Sila Alodio,

Pono ma ia ia ke wai no ka hoo'ohole a me ka hoo'ohole ana i ka olelo Peni,

No ka riimi a me ke pa'i ana i ka olelo ma ka Kupu'a, \$ Ken.

No ke kope ana i ka olelo kaina.

G.M. Robertson No ka palapala kii

J.M. Smith No ka hana ana i ka la, 31 o Mei 1849.

J. Kaulahao No ke kope ana i ka olelo a ma hoi'e

W.H. Ke No ke ana ana i ka la, 14 o Iulai 1852 Ua hana ke ana ana

No ke kope ana,

No ka hoo'ohole ana i ka olelo, Dekemaba 3. 1852

3 00

Eia ma palena, Anaia e L.S. Ua.

Ke ana ana i kekahi apana aina o Kapua, ma ke Ahupuaa o Pahua Lahai-
aina Maui. He apana kolo. E hoomaka ana ma ke kahi hoomohana o
keia aina ma kahi i pili ai i ka loi Poalima, a hoi aku, penei, Ak. 31°
Hik. 0.36 Kaul. ma ke Kahawai, alaila Hum. 2.1° Hik. 0.42. Kaulahao ma ke
Kahawai, Hum. 83° Hik. 3.09 Kaul. ma Kahawai, Hum. 81° Kom. 1.54 Kaul. ma ka pali
alaila, Ak. 57 1/2° Kom. 1 Kaul. ma ka auwai, alaila Hum. 76 1/2° Hoomohana 0.87 Kaul.
ma ka auwai, a hiki i ka loi poalima, alaila, Ak. 26 1/2° Kom. 0.40 Kaul. ma
ka loi poalima, a hiki i kahi i hoomaka'i, Ma ia Apana 28 Roda,

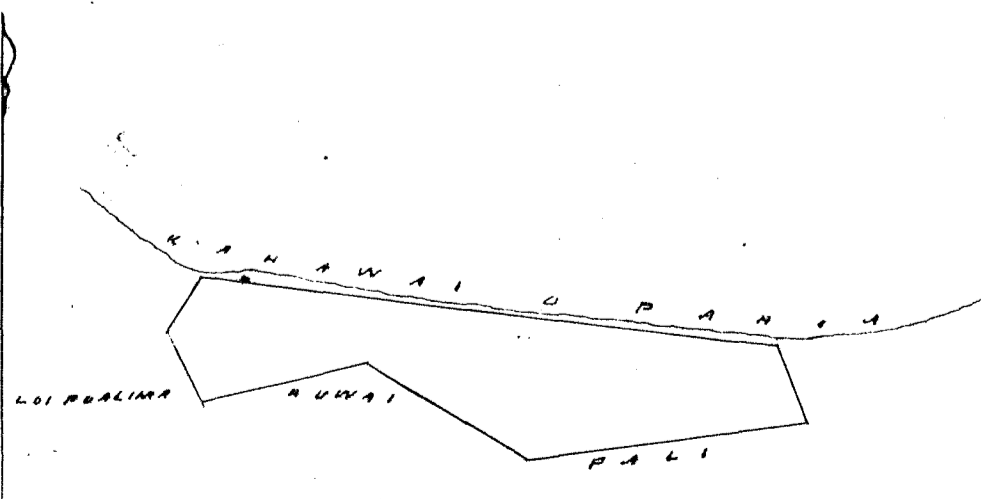

Ana 1 Kaul / Inik.

Ua kii mai oia no kona wahi ma Puhukunui, ma Labaina ma ka Mokupuni o Maui, ua lona ia ia keia wahi no kona mau kupuna mai i ka manawa o Kamehameha I, a ua noho keakea ole a hiki i keia manawa.

Oia ka makou e hooke nei no Lipi, ke kulu ana hoi kona malalo iho o ke ano Alodio, Iwa e aku mai oia i ke ki aupuni hapaha alaila, ua kupono ia ia ka Palapala Sila, Alodio. Pono nua ia ia ke aku no ka hoholo a one ka hoholo ana i ka olelo. Penei, Hen.

No ka oumi a me ke pui ana i ka olelo ma ka Kupuna, Hen.

No ke kope ana i ka olelo keia

No ka palapala kii

No ka huana ana i ka la, 11, o June 1849

No ke kope ana i ka olelo a ua hoiho

No ke ana ana i ka la

No ke kope ana,

No ka hoholo ana i ka olelo 4 Dekemaba 1852

G. M. Robertson

J. H. Smith

J. Okaulaha

W. A. Bee

Oia ma palama, Anais e W. P. Alexander.

He palapala hakaaka i ke ana ana i kekahi apuna aiaa Kuliaia o Lipi ke wahi ma Helu 2546 He aiaa e waiho ana ma Puhukunui, ma Labaina i Maui, e hoomaka ana ma ke kiki Akau Hikina o keia, a e holo ana.

Hema,	54°	Komohana,	3.12	Kaulaha ma ka aiaa o Pi
Komohana			3.32	" ma ka Maiana,
Akau	41	Hikina,	9.60	" ma ka Iwa aiaa
Akau	34	Komohana	2.02	" "
Akau	49	Hikina	4.90	" "
Hema	44	Hikina	2.06	" ma ka Oo o co
Hema	35 1/2	Hikina	2.55	" ma ka Oo o co
a i kahi i hoomaka i Ka ili Iwa Ika a me 36 Roda.				

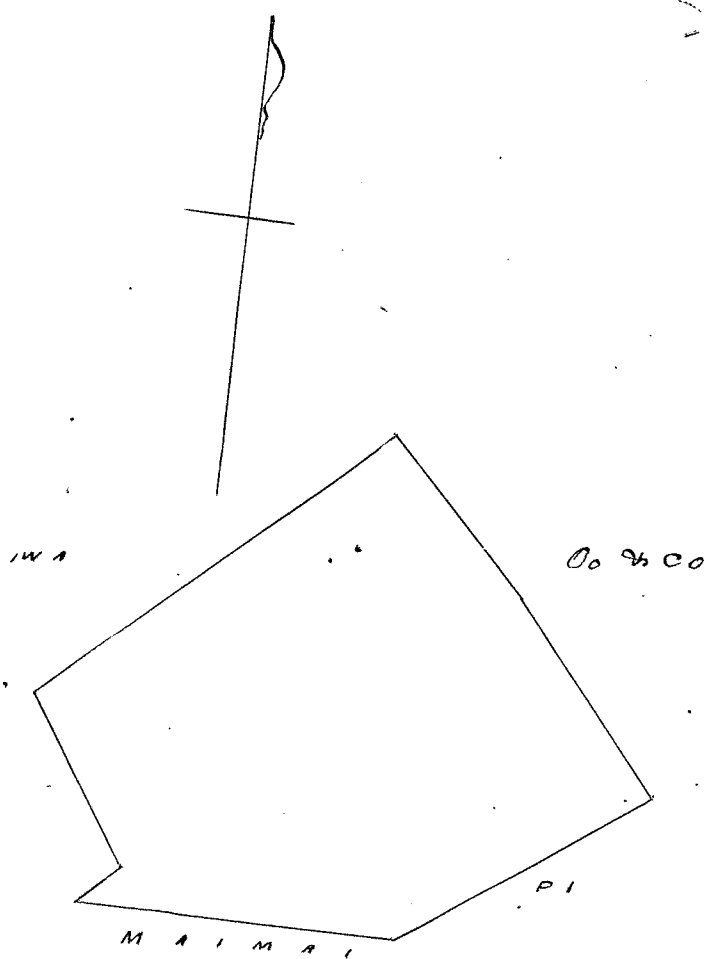

Hulu 3.419 B. Pūpule.

Ua hui mai ia no kona wahi ma Waikanae ma Lahaina ma ka Mokupuni Maui, wa loa ia ia keia wahi no, ke Alii Kamehameha III mai i ka makahiki 1837, a ua noho keakea oleia a hiki i keia manawa.

Oia ka makou e hoko nei no Pūpule, ke kuleana hoihona malalo iho, ke ano Alodio ma e uku mai ia i ke ke Aupuni kapahe, alaila, wa kupo ia ia ka Palapala Sila Alodio,

- Pono ma ia ia ke uku no ka hohokohole, a me ka hohokohole ana i ka olelo Penei,
- No ka rumi a me ke pui ana i ka olelo ma ka Kupuha, § Heni.
- No ke kope ana i ka olelo Niina
- No ka palapala kii
- G. M. Robertson No ka hana ana i ka la, 12 o Novembara 1852.
- J. H. Smith No ke kope ana i ka olelo a ma hiki.
- J. Kekaulaha No ke ana ana i ka la 31 Maraki 1852.
- W. Lee No ke kope ana
- No ka hohokohole ana i ka olelo 4 Iuhema 1852.

500

Oia ma palama. Anaina e L. S. Ua.

Ke ana ana i kahi apana uina o Pūpule, ma ke Ahupuaa, Waikanae ma Lahaina Maui.

Pahale, E hoomaka ana ma ke kahi Nihina, keia pahale, ma kahi i pili ai i ke Kalahe, a holo aku.

Hema,	33 1/4°	Nihina	0.68	Kaulaha ma ke Kalahe,
Hema	63 1/4°	Komohana	0.79	"
Akau	44 1/4°	Komohana	1.62	"
Akau	62°	Nihina	1.82	"
Hema	36 1/4°	Nihina	0.94	"
Hema	52	Komohana	0.80	"

o kahi i kahi i hoomaka i. Ka ili 36. Roda.

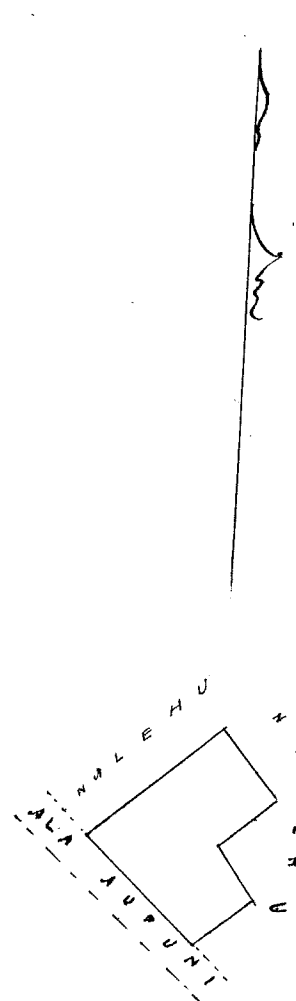

Ua hwi mai oia no kona wahi, ona Hooke, ona Lahaina, ona ka Mokupuni o Maui,
ua hwa ia ia keia wahi mai ke Honolulu mai, a ua na Kapu no i mahi mai ma kela wahi
me ke keakea oleia, a ua noho mau no oia malaila a hiki i keia manawa.

Oia ka makou e hooke nei no Kapu, ke huleana hwi kona malalo iho, ke ano Alodi,
Iona e uku mai oia i ho ke Anupuni hapaaha, adaila, ua kumpo ia ia ka Palapala Sila Alodi.

Pono nae ia ia ke uku no ke hooke oloko, a me ke hooke ana i ka olelo Penei:

No ka ruoni a me ke pui ana i ka olelo ma ka Kupapa. / Ken.

No ka kope ana i ka olelo keina

No ka palapala kii

No ka hana ana i ka la, 19 o Noemaba 1852.

No ke kope ana i ka olelo a ma hoi

No ke ana ana i ka la

No ke kope ana,

No ka hooke ana i ka olelo. 4 Dekemaba 1852.

G. M. Robertson

J. H. Smith

J. H. Kaulahao

W. H. Lee

4 00

Eia ma palena. Anaia e H. P. Alexander.

Ke palapala hwaia i ke ana ana i kekahi apana aina huleana o Kapu. Helu,
e waiho ana ona Hooke, ona Lahaina, Maui,

E hoomaka ana ma ke hiki Akau o keia apana, aina, a e holo ana.

Homa.	52 3/4	Homohana	204	Kaulahao e pili ana me Waikama
Akau.	51	Hikina	186	" " " Alio
Homa	37 1/2	Hikina	272	" " " Kapule.
Akau	34 1/2	Homohana	272	" " " Huana.

a hiki i ka hoomaka ai. Ka ili Ewa Ruda

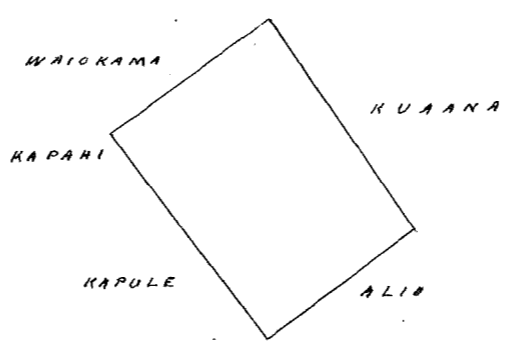
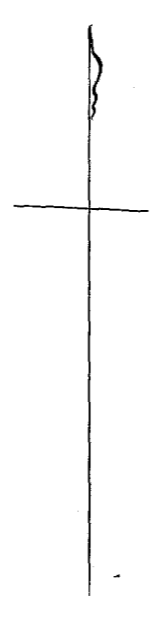

2 kau? - 1 in.

Kele 10534 Nāilili.

Ua kōi mai oia ou kōna wahi oia Puako oia Lahaina oia ka Mokupuni o Maui.
ua loa ia ia kōna wahi no. Kōna mai ka Luma i ka manawa o Hoopili oia oia
makaheke 1839, a ua nōho keakea oleia a hiki i kōna manawa.

Oia ka makou ~~oia~~ e hōko nei ou Nāilili he kōna hōi kōna matata iho, he nō
alodia. Oia e ukū mai oia i kōna Aupuni hapaha, atāia kōpono ia ia ka Palapala siba
alodia.

Pono oia ia ia, he ukū ou ka hōkōhōkō, a ou ka hōhō ana i ka olelo, Pemi

Ben

No ka rumi a me ke pū ana i ka olelo ma ka Nūpepa,
No ke kōpe ana i ka olelo kōna.

G. M. Robertson No ka palapala kōi

J. N. Smith No ka hōana ana i ka la, 9 o Iune 1849.

J. Kekaulāhae No ke kōpe ana i ka olelo a na hōike

M. L. He No ke ana ana i ka la, 10 o Januāri 1852. Ua kōna ana oia

No ke kōpe ana

No ka hōhō ana i ka olelo 4 Dekemata 1852

\$ 3 00

Oia ma palena. Anaia e L. S. Wa.

Ke ana ana i kōna hōi apāna ana o Nāilili, oia ke Nūpepa o Puako, oia
Lahaina, Mokupuni o Maui.

Ke apāna pūhale, a ou oia Lōi, e hōmaka oia ke kōi Kōmohana o kōna ana,
oia ke hōi i pili ai i kōna Kōna, Lāua me Kōna, a hōlo aku.

Akau 51' Kōna, 4.37 Kōna ma ke Kōna.

Akau 34 1/2' Kōna, 3.89 " Kōna

Akau 61 1/2' Kōmohana, 4.35 Mōmō

Akau 35 1/4' Kōmohana, 3.12 " Kōna.

a hōi i kōna hōmaka ai Maia Apāna, 1 Eka, 1 Pūda, 28 Pūda.

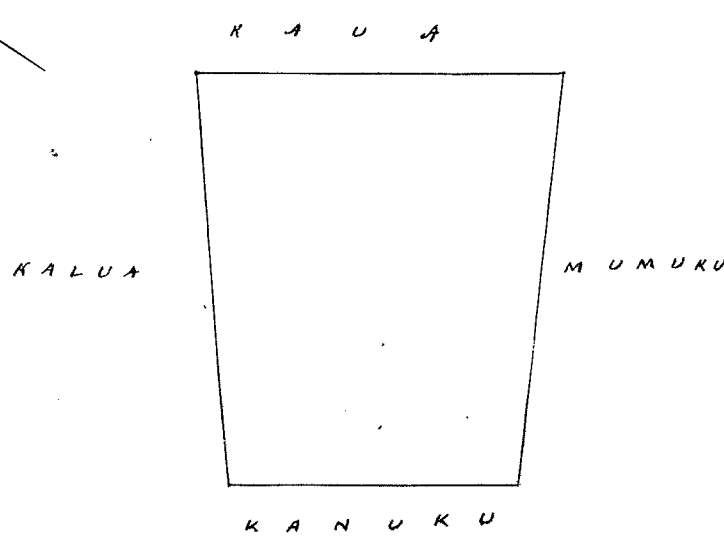
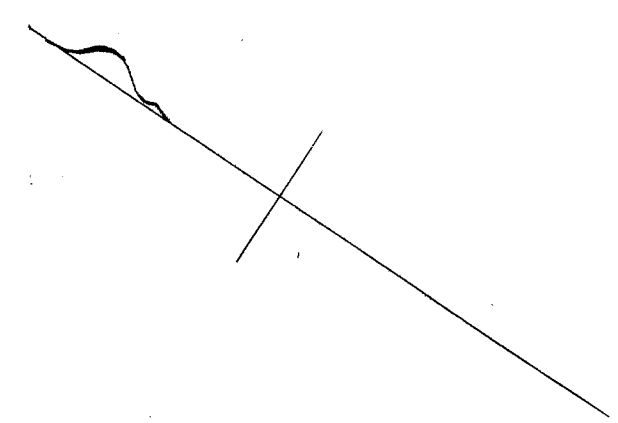

2 Kōna = 1 Eka

Heleu 581 Solomon Laahili.

149

Ua hui mai via no kona wahi ma Puchuhunui, ma Tahaina, ma ka Mokupuni o Maui, ma hua ia ia hua wahi, no ke Alii Kamuekamueka III mai ma ka Mahalo Aina ana i ka Makahiki 1848, a ua noho keakea oia i hiki i keia manawa.

Oia ka maku e hoko nei no Solomon Laahili, he kuleana hoi kona matata iho o ke Aho Alodia, Iwa e uku onai via i ke ke aupuni hapaha, ataita hupona ia ia ka Palapala Sila Alodia.

Pou mai ia ia ke uku, no ka hokohoko, a me ka hoholo ana i ka olelo Puni;

No ka rumi a me ke ipai ana i ka olelo ma ka Mupupa,

No ke kope ana i ka olelo hoima,

No ka palapala hii,

No ka hana ana i ka la,

No ke kope ana i ka olelo a ma hiki,

No ke ana ana i ka la,

No ke kope ana,

No ka hoholo ana i ka olelo, i Dekemaba 1852.

G. M. Robertson

J. H. Smith

A. Kaulahao

M. Lee

Ken.

\$ 5 10

Cia ma palama Anania J. P. Alexander.

Ie palapala huakaaka i ke ana ana i ke kahi apama aina Kuleana o Solomon Laahili Heleu 581 He loi ia, e waiho ana ma Puchuhunui, ma Tahaina i Maui,

E huomaka ana ma ke kahi Anua Komohana, o hua, ma ke ala aupuni, e pili ana i ka Poalima, ma kahi hoi i moe ai, ke kahi Akau Komohana o ke Naholawa i ka Anua 51. Hihina 115 Kaulahao, a e holo ana,

Akau 54° Hihina 231 Kaulahao ma ka Poalima

Akau 48 1/2° Komohana 4.18 " ma ke ala kahiko

Anua 51 1/4° Komohana 2.23 " ke Anua,

Anua 48 1/4° Hihina 4.03 " ma ke ala aupuni.

a i ka huomaka ai.

Ka ili Ekolu Ruda Iwakaalwatumamalima Ruda,

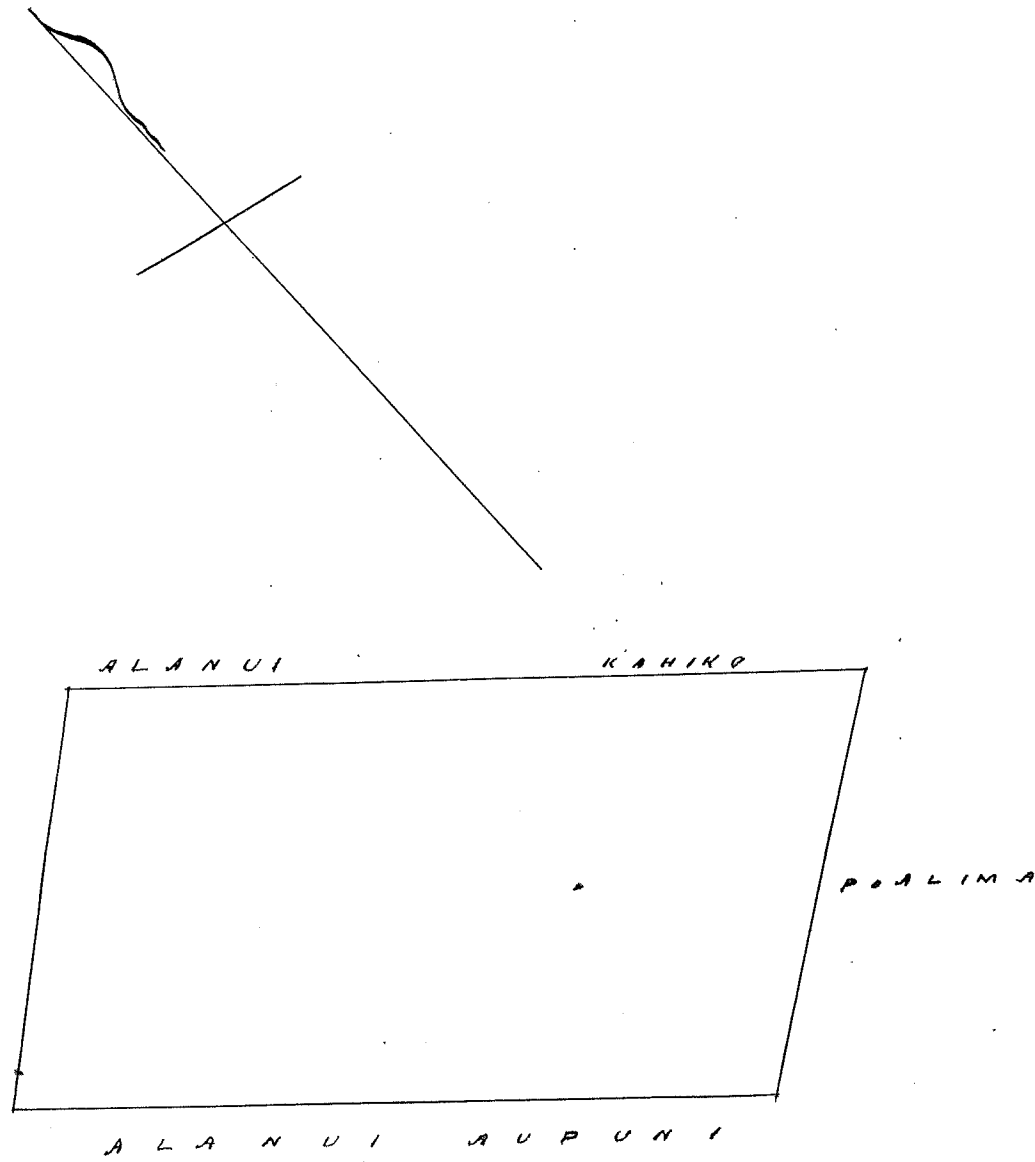

Kolu 1001 Keaweuaole, Ua maake.

Ua hoi mai oia no kona manuwahi ma Paunau ma Lahaia ma ka Mokupuni o Maui, ua loa ia ia kua manuwahi ma.

Oia ka maake e hooke nei no Keaweuaole, he kuleana hoi kona maale iho o ke ano Alodis, Ina e uku mai oia i ke ke Anupuni hapaha alaila kupo ia ia ka Palapala Sila Alodis

- Pono mai ia ia ke uku no ka hookelele a mi ka hookelele ana i ka olelo, *Jeney* \$ *Hon.*
- No ka lumi a mi ke paai ana i ka olelo ma ka Kupupe
- No ke kope ana i ka olelo koina
- No ka palapala kii,
- No ka kama ana i ka la,
- No ke kope ana i ka olelo a oia hoi ke,
- No ke ana ana i ka la Ua kaa ke ana ana \$3.00
- No ke kope ana,
- No ka hookelele ana i ka olelo i Dekemaba 1852.

G. M. Robertson
 J. H. Smith
 J. Kekaulaha
 W. Lee

\$ 500.

Oia ma palena, Aiaia W. P. Alexander.

E kolu manuwahi kuleana ma e waiho ana ma ke ahupuaa, Paunau ma Lahaia, Maui.

Apana 1. E hoomaka ana ma ke kahi Nema, a e holo ana,

Akau	36 1/2	Komohana	0.63	Kaul. e pili ana ma ke Uoniuoni
Akau	50 1/2	Hikina	3.23	" " Timoteo
Akau	51 1/4	Hikina	2.11	" " Kamaooha
Nema	33 1/2	Hikina	0.73	" " Timoteo
Nema	51 1/2	Komohana	5.31	" Anupai o Keaweuaole

Ka ili 1 Ruda o Umikumamawalu Ruda,

Apana 2. Oia i ke awawa o Kahoma,

E hoomaka ana ma ke kahi Nema Komohana a e holo ana,

Akau	72 1/2	Hikina	4.25	Kaul. e pili ana ma ke Kamaooha,
Akau	20	Komohana	0.53	" " Kuumiuoni
Akau	73	Hikina	0.30	" " "
Akau	14	Hikina	0.84	" " "
Nema	79 1/2	Komohana	2.45	" a hiki i kula ka o ke Kahawai,
Nema	36	Komohana	0.94	" e pili ana ma ke Kulu,
Nema	62	Komohana	1.67	" " "
Nema	28 1/2	Komohana	0.70	" a hiki i kahi i hoomaka i

Ka ili 2 Ruda o Iwakaupua Kumamawalu Ruda

Apana 3. Oia no hoi ia ma ke awawa o Kahoma,

E hoomaka ana ma ke kahi Nema Kom. a e holo ana,

Akau	49 1/4	Hikina	1.09	Kaul. e pili ana ma ke Kamaooha,
Akau	78	Hikina	2.07	" " "
Akau	66 3/4	Hikina	3.27	" " Kahula,
Akau	80 1/4	Hikina	1.68	" " "
Nema	6 1/2	Hikina	1.22	" " "
Nema	57	Komohana	1.36	" " Kaitiwa
Nema	76	Komohana	2.43	" " "
Nema	73 3/4	Komohana	4.00	" " "
Akau	15 1/4	Komohana	0.73	" " "

a hiki i kahi i hoomaka i Ka Ili Iwakaupua Kumamawalu Ruda,

Nama Awao 281.

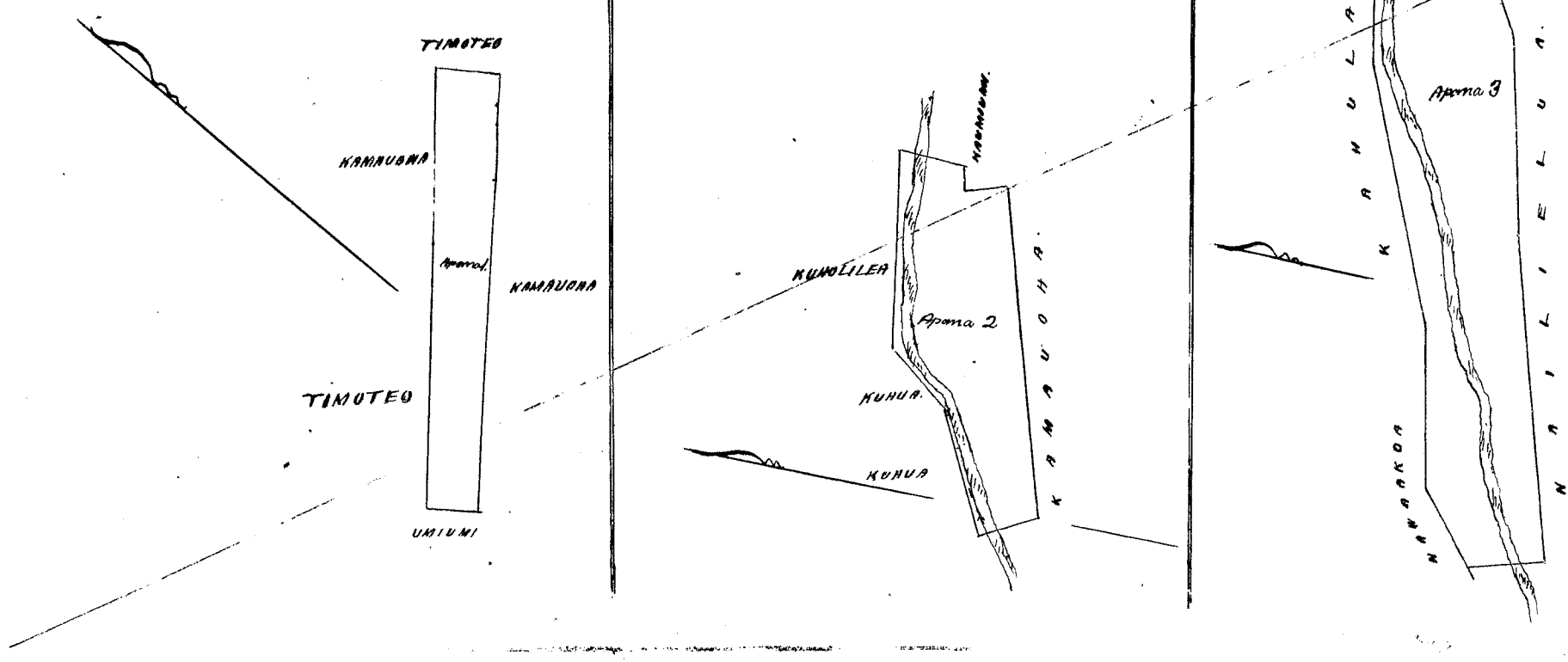

Olelohoakaka
 Na ho'oponopono honua keia mau
 Apana, Heawaluale, E mana ma
 ka Awao 281 o keia Buke no,
 Aka o ka la i'ho'ko'i'i, oia mau
 no.
 J.L. Kailiiki
 November 12, 1853, Ika Kakaulelo.

2 Apana to one Apana

Helu 475 Mau

Ua hoi mai oia no kona mau wahi ma Puako a ma Halew i Laha'ina, ma ka Mokupuni o Maui, no ka mea, ua loa ia ia keia mau wahi no kekahi mau kanaka mai elua, a ua noho keakea oia a hiki i keia manawa.

Oia ka makou e hooke nei no Mw; he kuleana hoi kona matato iho o ke Awa Alo'io. Ima e uku mai oia i ke ke Aupuni hapaha; alaila, ua ho'opono ia ia ka Palapala Ika Alo'io. Pono nae ia ia ke uku no ka hoo'oholo a me ka hoo'oholo ana i ka olelo. Ienei,

- G. M. Robertson
- J. H. Smith
- J. Heaulakoo
- M. Hee

- No ka rumi a me ke pua ana i ka olelo ma ka Mepapa
- No ke kope ana i ka olelo koina
- No ka palapala kii
- No ka hawa ana i ka la 17 o Apru 1849.
- No ke kope ana i ma olelo a wahi ke Nawao
- No ke ana ana i ka la 23 o Iulai o L.S. Wa. Ukuia ana.
- No ke kope ana
- No ka hoo'oholo ana i ka olelo Dekemaba 4, 1852.

Ken

5.00

Oia ma palawa. Apana i L.S. Wa & W.P. Alexander

Ke ana ana i kekahi Apana. aia no Mw ma ke Aupuni o Puako ma Laha'ina i Maui.
 E hoomaka ana ma ke kii Heema o keia pahala ma kahi i fili ai i ke Alanui liili a me ka Paahana, a holo aku No. 58 Iki. 1.95 Haul. ma ke Paahana a hiki i ke C. Hanaina; Alaila No. 21 Iki. 0.86 Haul. ma ke C. Hanaina; Alaila Kom. 52. No. 2, 19 Haul. ma ke Iki. 2. Hoomau; Alaila Kom. 38 1/4 Iki. 0.62 Haul. ma ke Alanui liili a hiki i kahi i hoomaka ai.
 Ma ia Apana 23 Roda Apana L.S. Wa.

Apana 2. Ke ana ana i ke Apana o Mw, he Apana lele, o Halew ma Laha'ina Maui.
 E hoomaka ana ma ke kii Heema Uku, a e holo ana i ka aia o na Misionari Amerika
 Heema 23° Ikiina 0.86 Haulakao e fili ana i ka aia o na Misionari Amerika
 Heema 65° Komohana 0.45 " " " " " "
 Heema 23° Ikiina 0.80 " " " " " "
 Apan 89 1/2° Komohana 1.75 " " " " " "
 Apan 14 1/2° Komohana 1.45 " " " " " "
 Apan 82 1/2° Ikiina 2.00 " " " " " "
 ana. Malaila 1 Roda 8 Roda
 Apana W.P. Alexander

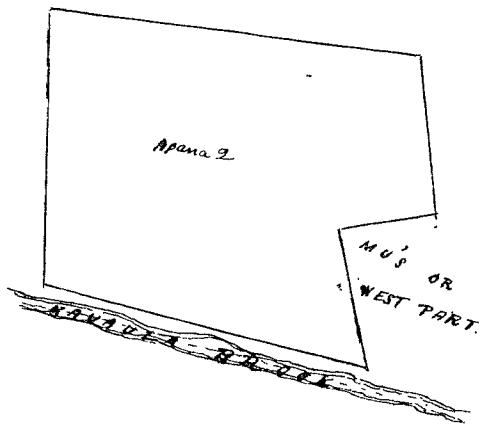
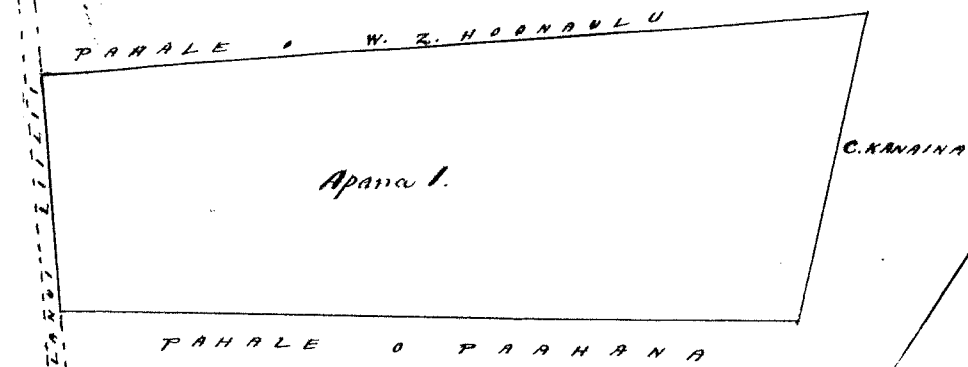

Ana { Apana 1 = 1 MAULAAO = 2 INIHA
 " 2 = 1 MAULAAO = 1 INIHA.

Heleu 286 Keawa

Uu kei mai oia no kona mau wahi ma Moalii a me Puako i Lahaina ma ke Mokupuni o Maui; no ka mea, ua loa ia ia keia mau wahi no Hoopilikane mai i ka Makahiki 1837, a ua noho keakea oleia a hiki i keia manawa.

Oia ka makou e hoohe nei no Keawa; ke hulemau hoi kona malalo iho o ke Ano Alodio. Ana e utu mai oia i ke ke Aupuni hapahai; alaila, ua kufuru ia ia ke Palapala Ika Alodio.

Pono naia ia ke utu no ka hoohehoohe a me ka hoohehoohe ana i ka olelo. Ienei, — \$ Ken.

- No ka rumi a me ke paia ana i ka olelo ma ka Kupepa
- No ke kope ana i ka olelo kima
- No ka palapala kii
- No ka hana ana i ka la
- No ke kope ana i ma olelo a ma huike
- No ke ana ana i ka la 15 Iulai 1851 & 26 o Ianuari 1852.
- No ke kope ana
- No ka hoohehoohe ana i ka olelo Ikenewaba 4, 1852.

Oia na palapala Anai a L. S. Oa & M. J. Alexander

\$ 10.00

Moalii Ke ana ana i ke kahi mau Apana i ma Keawa ma ke Aupuni o Moalii ma Lahaina Mokupuni o Maui.

27P
 2.37
 3.58
 1.1.37
 1.1.33
 3 X
 85.2.2
 Peako 126

Apana 1. He palapala ma Keali, Kaala. E hoomaka ma ke kahi Apana Komo-hana o keia ana ma kahi i pili ai ia Kaohu laua ma Kaiwi a holo aku
 Komo 72' Kikina 2.52 Kaalaha ma Kaiwi laua o Moakaka
 Komo 5 1/2' Komo-hana 0.60 " " Kaohu
 Komo 76 1/2' Komo-hana 2.47 " " Kaka
 Komo 7 1/2' Kikina 0.80 " " Kaohu
 a hiki kahi i hoomaka ai Ka ili 27 Roda.

Apana 2. E lua mo Kula. E hoomaka ma ke kahi Komo Komo-hana ma kahi i pili i ka palapala a me ke Aupuni, a holo aku
 Komo 8' Kikina 1.05 Kaalaha ma ke Aupuni
 Komo 82 1/4' Kikina 6.06 " " palapala
 Komo 18 1/4' Kikina 1.14 " " Moakaka
 Komo 82 1/2' Komo-hana 6.55 " " "
 a hiki i kahi i hoomaka ai. Ka ili 2 Roda 27 Roda

(E mana e ma o.)

*Apana 3. He mau moe Aua. E hoomaka i ke kiki Aka Komohana o keia Apana
 aino kula ma kahi i pili ai i ke Uwanui a me ka foalima, a holo aku
 Hema 87 1/2 Hikina 6,00 Kaulahao ma ke Uwanui
 Hema 6 1/4 Komohana 1,86 " " Kamanowai
 Aka 84 1/2 Komohana 5,86 " " D. Malo.
 Aka 1 1/2 Hikina 1,00 " " foalima
 a hiki i kahi i hoomaka ai. Ka ili 3 Ruda 33 Ruda.*

*Apana 4. He Aua. E hoomaka ana ma ke kiki i pili ai i ke Kamanui hawa o
 Kamanowai, a holo aku ka
 Hema 15 1/4 Komohana 1,16 Kaulahao ma ke D. Malo
 Hema 21 1/4 Hikina 1,20 " " Kamanui
 Hema 79° Hikina 6,39 " " "
 Aka 84 1/2 Hikina 2,45 " " "
 Aka 3° Hikina 0,57 " " Kari Paka
 Hema 73 1/4 Komohana 9,28 " " Kamanowai
 a hiki i kahi i hoomaka ai. Ka ili 1 Eka, 1 Ruda, 37 Ruda.*

*Apana 5. He mau moe elua a me kahi fukaai maloko o ke ili o "Kau". E hoomaka
 ana ma ke kiki Hikina Hema o keia ma kahi i pili ai i ke D. Malo a me ka foalima, a holo aku
 Aka 78° Komohana 6,21 Kaulahao ma ke D. Malo
 Aka 11° Hikina 0,35 " " "
 Aka 74 1/2 Komohana 2,61 " " "
 Hema 86 1/2 Hikina 3,24 " " a hiki i ke kaulahao
 Aka 15 1/2 Hikina 1,45 " " Kahakahi
 Hema 79 1/4 Hikina 4,32 " " Kamanowai
 Hema 70° Hikina 1,26 " " "
 Hema 72° Hikina 3,83 " " " a hiki i ke ilu
 Hema 79 3/4 Hikina 2,47 " " "
 Hema 10° Komohana 1,00 " " foalima a hiki i kahi i hoomaka ai.
 Ma keia Apana 1 Eka, 1 Ruda, 33 Ruda. L.P. Ma.*

*Apana 6. He kikapai, E waiho ana ma ke Ahupuaa o Moalii i Lohaina, Maui.
 E hoomaka ana ma ke kiki Hema Komohana ma ke fuka a pili ana i ke Alanui Ahupuaa, a holo ana
 Hema 74 3/4 Hikina 2,45 Kaulahao i pili ana ma ke Kamanui
 Hema 65 3/4 Hikina 4,53 " " "
 Hema 86 1/4 Hikina 1,85 " " foalima
 Aka 10 1/2° Hikina 0,59 " " "
 Aka 69 3/4 Komohana 6,14 " " Kiahakahi
 Hema 18 1/4 Komohana 0,38 " " "
 Aka 58° Komohana 3,20 " " D. Malo
 Hema 8 1/2 Hikina 1,39 " " Alanui Ahupuaa
 a hiki i kahi i hoomaka ai. Ka ili Ekolu Ruda. C.F. Alexander*

*Apana 7. He ana ana i ke pahale o Kawa ma Hawaiiheke, Ahupuaa o Puaka
 Lohaina, Maui.
 E hoomaka ana ma ke kiki Komohana o keia pahale ma kahi i pili ai i ke George Shaw
 a me ke Alanui Kaulapule, a holo aku penei; Hema 51 3/4 Hikina 2,24 Kaul. ma ke Alanui Kaulapule; Alaila
 Aka 48° Hikina 1,90 Kaul. ma ke Alanui o Henry Swinton, - Alaila Aka 37 1/2 Komohana 2,37 Kaul.
 ma ke pahale o Kaulapule, - Alaila Hema 44° Komohana 2,49 Kaul. ma ke pahale o George Shaw
 a hiki i kahi i hoomaka ai. Ma keia Apana 1 1/2 Eka. L.P. Ma*

Enana ma o i na kii.

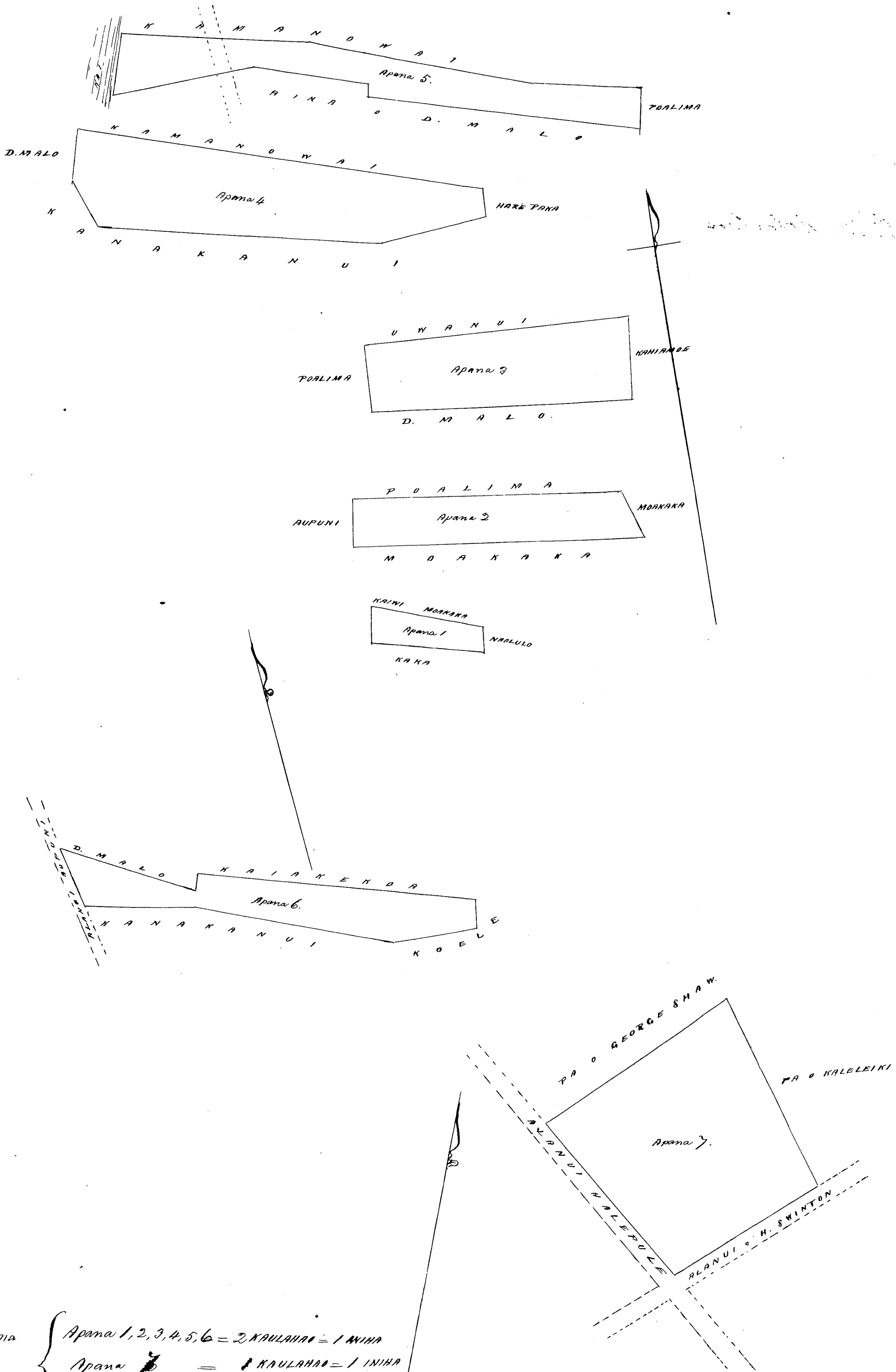

Apana { Apana 1, 2, 3, 4, 5, 6 = 2 KAULAHAA = 1 NIHA
 Apana 7 = 1 KAULAHAA = 1 NIHA

Ua hoi mai oia no kona wahi ma Ahi i Lahaina ma ka Mokupuni o Maui; no ka mea, ua loaa ia ia keia wahi no Hoapili wahine mai i ka Matakahi 1841, a ua noko keakea oleia a hiki i keia manawa.

Oia ka makou e hoko nei no Kaenaena; ke kuleana hoi kona maalo iho o ke Aloha. Ina e uku mai oia i ka Ala o Kupuni hapaha; alaila, ua kupaia ia ia ka Palapala Pila Aloha. Pono nae ia ia ke uku no ka hoko kolo a me ka hoko ana i ka olelo. Ima, -

No ka ruhi a me ke paia ana i ka olelo ma ka Mapepa
No ke kope ana i ka olelo koina
No ka palapala kii
No ka hana ana i ka 13 o Februari 1852.
No ke kope ana i na olelo a ma hoihae
No ke ana ana i ka 10 o March 1852.
No ke kope ana
No ka hoko ana i ka olelo Dekemaba 4, 1852.

G. M. Robertson

J. H. Smith

J. Kekaulahe

H. Hee

Oia na palena. Inaia o L. S. Ua.

\$ 5.00

He ana ana i kekahi Apuna ana o Kaenaena ma ka Mokupuni o Ahi i Lahaina Mokupuni o Maui. He Pahale. E hoomaka ana ma ke hiki Aha o keia pa ma ka hiki i fili ai i ka pa o Pika a me ke Ala o Kupuni, a holo ana Heema 48° Hikiina 1,50 Kaulahe ma ke Ala o Kupuni Heema 43° Komohana 1,00 Kaulahe ma ke Ala o Nawakoa; Aha 48° Hikiina 1,50 Kaulahe ma ke kai; Aha 43° Hikiina 1,00 Kaulahe ma ka pa o Pika a hiki i ka hiki i hoomaka ai. O kona ili Oka Roda.

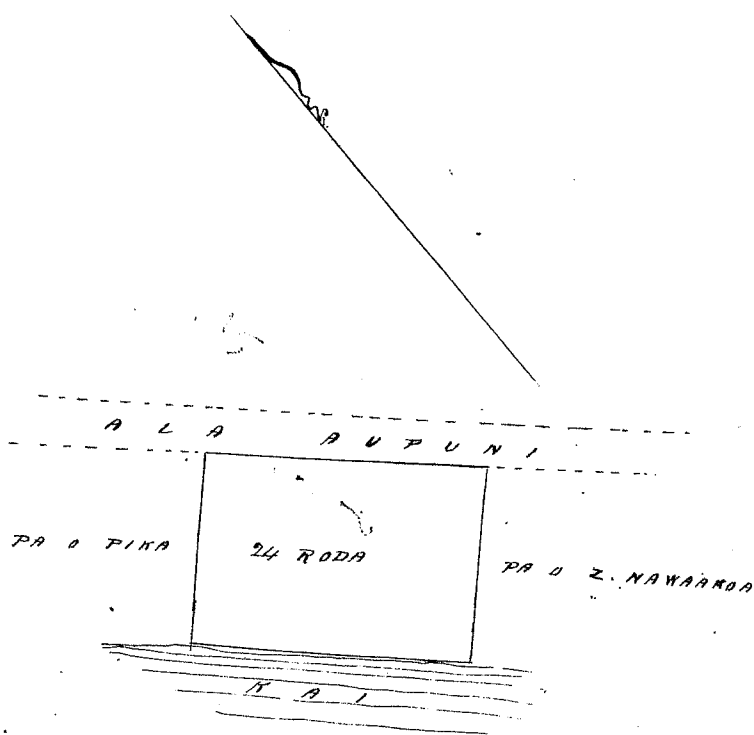

Helu 1795 B. Kaaua

Ua kōi mai oia no kona mau wahi ma Aki i Lahaia ma ka Mokupuni o Maui; no ka mea, ua loa ia ia keia mau wahi i ka wa. Kōmehameha II. mai, a ua wōho keakea keia a hiki i keia manawa.

Oia ka maku e hōko nei no Kaaua; ke hūlema hōi kona malalo iho o ke ano Alodio. Ina e ukui mai oia i ke ke Aupuni hapaha; alaila, ua hūpano ia ia ka Palapala Sila Alodio.

ʻIono mau ia ia ke ukui no ka hōkolo hōlo a me ka hōkolo ana i kea olelo. Penei,

- No ka sumi a me ke pari ana i kea olelo ma ka Muepua
- No ke kope ana i kea olelo hōina
- No ka palapala kii
- No ka hana ana i kea la
- No ke kope ana i na olelo i na hōiko
- No ke ana ana i kea ka 11 Oct & 28 Nov. 1851 & 29 Feb. 1852.
- No ke kope ana
- No ka hōkolo ana i kea olelo Dekemab a 4, 1852.

\$ Ken.

G. M. Robertson
 J. N. Smith
 J. Kikaulahas
 W. Lee

Eia na palena. Anaiia e L. S. Wa.

\$ 5.00

Apama. Ke ana ana i kekahi Apama aina o Kaaua, (Ua maki ia, o Heneri kona hōolina) ke ili keia o Waieiki ma ke Aupunaa o Aki ma Lahaia, Maui.

E hōmaka i ke ana ma ke kiki Hema o keia aina ma kekahi i fūli ai i ke ʻO. Nawaaka a me Moami, a e holo ana ka arao mau

Akau 34 1/2	Komohana	3, 14	Kaulakar	ma ke ʻO. Nawaaka & kahawai.
Akau 77 1/2	Hikina	1, 94	"	" Moikeha
Akau 37	Hikina	4, 21	"	" "
Akau 4	Hikina	0, 82	"	" "
Akau 81 1/2	Komohana	0, 91	"	" Pūpuka
Akau 16	Hikina	1, 24	"	" "
Hema 84	Hikina	0, 40	"	" "
Hema 19 1/2	Komohana	0, 58	"	" Kaluatinani
Hema 81	Hikina	0, 44	"	" "
Akau 1 1/2	Hikina	3, 28	"	" "
Akau 23	Hikina	1, 20	"	" "
Hema 36	Hikina	1, 83	"	" Paohi
Hema 17 1/2	Komohana	0, 46	"	" "
Hema 24	Hikina	0, 95	"	" "
Hema 9 1/2	Komohana	1, 29	"	" "
Hema 28	Hikina	2, 00	"	" " a ohi aku la ke kahawai
Hema 41	Komohana	2, 91	"	" Moami
Hema 44	Hikina	0, 91	"	" Moikeha
Hema 17 3/4	Komohana	0, 96	"	" ka Auwai
Akau 55	Komohana	1, 15	"	" loi pūalina
Hema 47	Komohana	1, 45	"	" ko Pūo
Hema 48	Hikina	1, 35	"	" "
Hema 63 1/2	Komohana	3, 13	"	" e holo ana ma Moami

E. P. 2.3.2
 18
 1
 18

a hiki i kahi i hōmaka ai. Maloko o keia ana 2 Eka 3 Ruda 28 Ruda

Apama 2. Ke ana ana i kekahi loi no Kaaua, aia i loko o ka ili o Waieiki ma ke Aupunaa o Aki ma Lahaia, Mokupuni o Maui.

E hōmaka ana ma ke kiki Hikina o keia loi, a ua pūni hōi ua loi nei ia Moikeha, a e holo ana ka arao mau Akau 37 Komohana 1, 13 Kaulakar ma ke Moikeha

- Hema 49 Komohana 1, 06
- Hema 34 1/2 Hikina 1, 00
- Akau 56 Hikina 1, 11

Ma ia Apama aina 18 Ruda

Apama 3. He ana ana i kekahi Apama aia o Hanaa ma ke Ahupuaa o "Ahi" ma Lakaia i Maui,
 He Pahale heip, kahi e hui nei ke Hale fihaku o Kahamuu. E hoomaka ana ma ke kahi Hema
 o keia ma kahi i pili ai ia Kahie laua o Haa, a e holo ana
 Haa 45 Komohana 1,79 Naulakaa ma ke Haa o Kaenana o Himo
 Haa 46 Hikina 4,52 " " Namauu o Hahumui
 Hema 28 Hikina 2,58 " " ke Ala liili
 Hema 58 Komohana 1,79 " " ke Kahie
 Hema 53 1/4 Komohana 2,09 " " a hiki i kahi i hoomaka ai.
 Eia ka ili 3 Puda 14 Puda. —

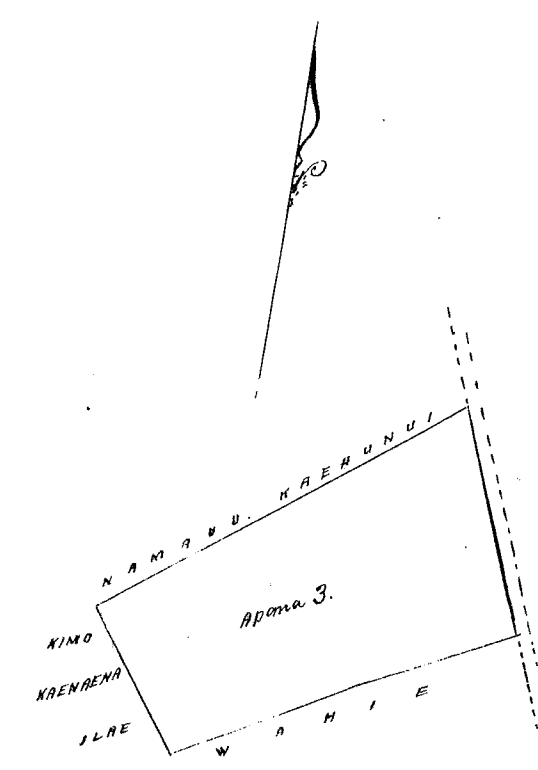
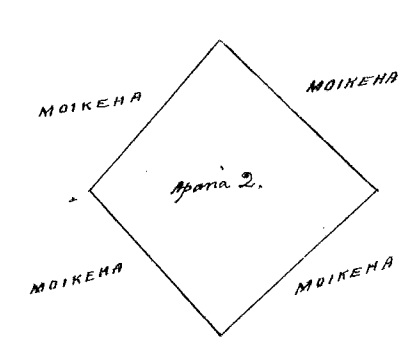
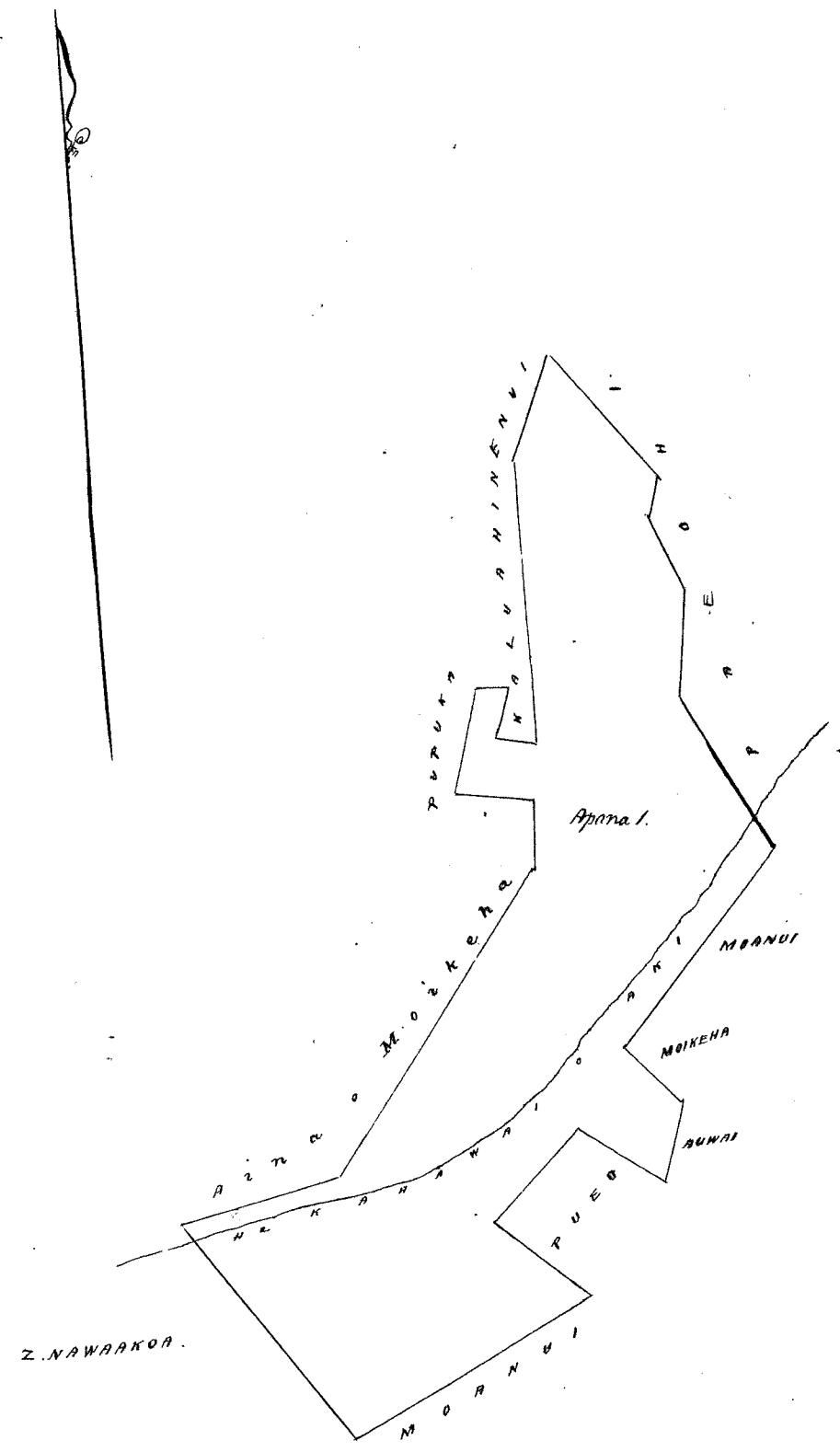

Scale 2 chains to an inch

Helu. 5116. Samuela Kanae

Ua hoi mai oia no kona wahi ma Panaua ma Lahaina ma ke Moku o Maui; no ke mea; ua hooa ia ia keia wahi no Hoapili Keane mai i ka makahiki 1835, a ua noho-keakea oleia a hiki i kona wahi ana i ka makahiki 1848, a hooili i keia wahi ia Kekaula a muke kuitamane, a ua noho-keakea oleia laua a hiki i keia manawa.

Oia ka moku a hooke me no Samuela Kanae; he kuleana hoi kama-matato iho o ke Alo Alo. Ima e ukia mai oia i ke ke Aniani hapalea; aiaita, ua kupaia ia ia ka Palapala Alo Alo. Iono nae ia ia ke ukia no kea hookelelele a me ke hookelelele ana i ke olelo. Ima

A. M. Robertson

J. N. Smith

J. Kekaula

M. K.

No ke kumi a me ke paia ma i ke olelo ma ke Moku o Maui

No ke kope ana i ke olelo koina

No ke palapala kii

No ke paia ana i ke ka 12 o Ima, 1849.

No ke kope ana i ke olelo a me ke kope

No ke ana ana i ke ka *Ukuaia ke ana ana*.

No ke kope ana

No ke hookelelele ana i ke olelo Ima 4, 1852.

Ima

\$ 3.00

Oia ma palena.

Maui o P. S. Ma.

Maui. He ana ana i kekahi Apama aia o Samuela Kanae ma ke Moku o Maui ma Lahaina, Moku o Maui.

He paia ana ma ke kope kope o keia paia, ma ke kope i fili ai i ke Moku a me ke Alo Alo, a e hoo ana.

Maui 44° Hikina 0.41 Kaula ma ke Moku

Maui 44½° Hikina 1.72 " " " kama o J. Kamae

Maui 44° Hikina 0.53 " " E. Kamae a hiki i ke Alo

Maui 49° Hikina 1.74 " " ke Alo a hiki i kekahi i hookelelele ai.

Maui o keia Paia.

12 Roda

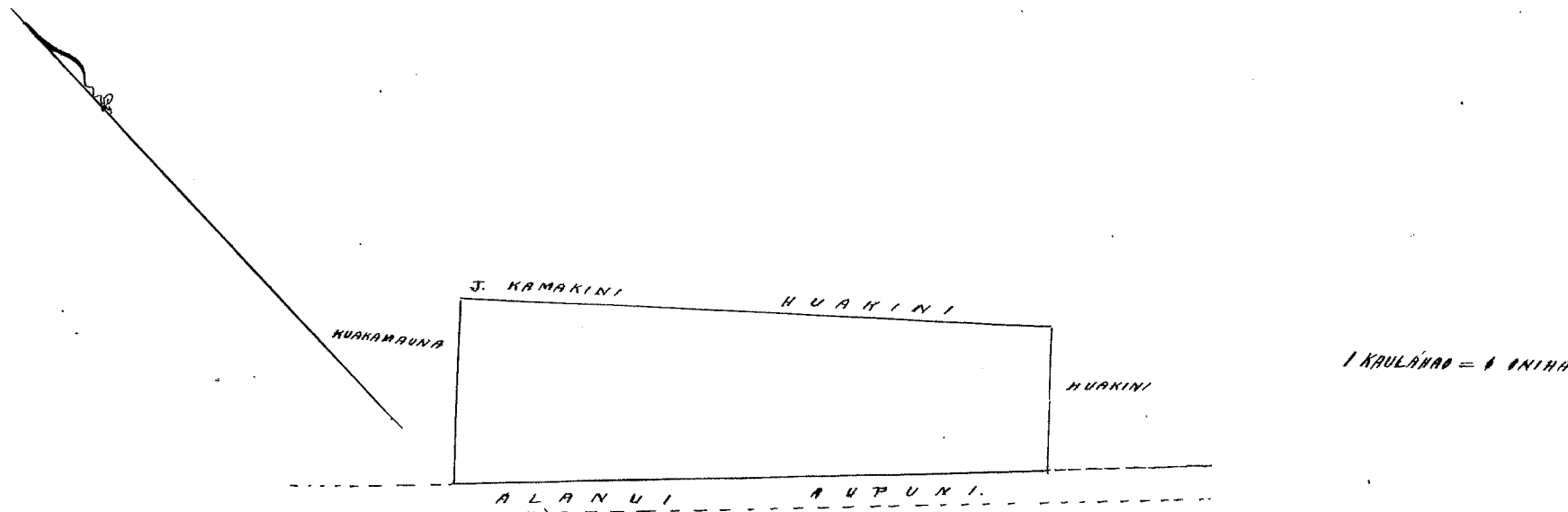

Ua koi mai oia no kona wahi ma Punahoa i Hilo ma ka Mokupuni Hawaii, no ka mea, ua loa ia ia keia wahi no Piope mai kona wahine, a ua noho keakea oia a hiki i keia manawa.

Oia ka makou a hoko nei no Katakuaioho, he kuleamahi kona makalo iho o ke Aho Aloha. Ana e ukui mai oia i ke ke Aloha kapaha; alaila, ua kupono ia ia ka Palapala Pila Aloha. I no mai ia ia ke ukui no ka hokohoko a ma ka hoholo ana i ka olelo Penei, -

\$ Cen.

No ka omni a ma ke pui ana i ka olelo ma ka Mapepa

No ke kope ana i ka olelo koma

G. M. Robertson

No ka palapala kii

C. A. Smith

No ka hana ana i ka la 15. Novemaba 1848

J. Kakaulaha

No ke kope ana i wa olelo a ma hiko

W. Lee

No ke ana ana i ka la

No ke kope ana

No ka hoholo ana i ka olelo Ichemaba 9, 1852.

\$ 6.00

Oia ma pakena. Anai e H. M. Lyman

Punahoa 1, Hilo, Hawaii.

Sikale. E hoomaka keia ma ke kiki Komohana o keia i pili ana ma Pitman & Church Streets, a e holo ana Church Street Maaw 51' Hiki 2, 17' kaul. a hiki i ke kiki o Bridge Street; alaila, e holo ma Bridge Street Hana 55 3/4' Hiki 3, 26' kaul; alaila e holo ma ka aia o Keoni Pukiki a ma ke kuleana o Kakaulepo Hana 50 1/2' Kom. 3, 23' kaul. a hiki i Pitman Street; alaila e holo ma ua Alamui la Ma. 36 1/2' Kom. 3, 25' kaul. a hiki i kahi i hoomaka'i.

Muloko o keia Apana 7/8 o ka Eka.

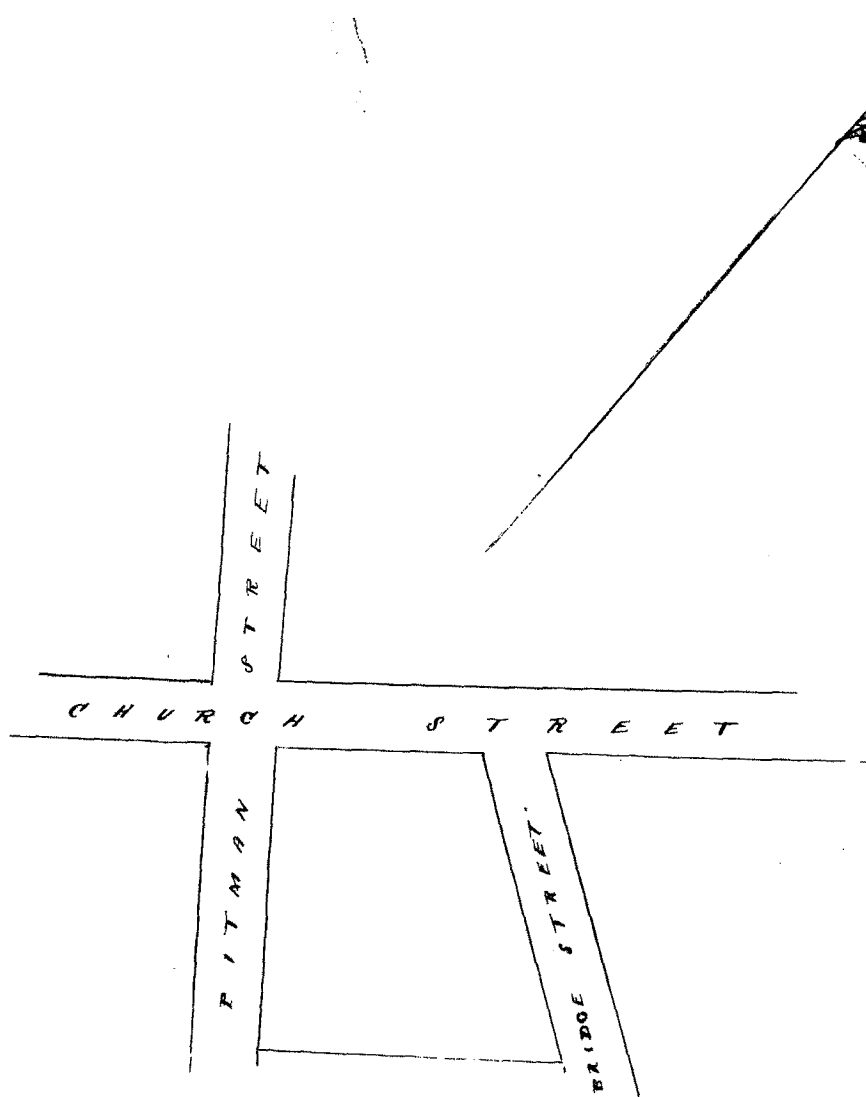

2 Chains to an inch

Kele 2327 Barenaba

Ua koi mai oia no kona wahi ma *Naiakea i Silo ma ka Moku o Hawaii*,
no ka mea, ua loaa ia ia keia wahi

Oia ka makua a hooko mai no Barenaba; he kuleana kua oia ma ka wahi oia i ke
Alodio. Ima e uku mai oia i ke ke *Alodio* kua kua; alaila, ma ka pua oia ia ke Palapala
Silu Alodio

Pono nae ia ia ke uku no ka hooko oia a me ka hooko ana i ke olelo. Penei,

\$ Ken.

- W. L. Lee
- G. M. Robertson
- J. H. Smith
- J. Kekaula
- ~~H. H. H.~~

- No ka umu a me ke pua ana i ke olelo ma ka Moku o Hawaii
- No ke kope ana i ke olelo *Maui*
- No ka palapala kua
- No ka hana ana i ke olelo 17 & 21 o Novemaba 1848.
- No ke kope ana i ke olelo a me ke kope 1 Alodio
- No ke ana ana i ke olelo 19 Novemaba 1852.
- No ke kope ana
- No ka hooko ana i ke olelo Dekemaba 9, 1852.

Oia na palapala. Imaia e *H. M. Lyman*.

\$ 10 00

Naiakea, Silo, Hawaii.

Aina. E hooko ka ana ana o keia ma ke kua *Alodio* o keia a
pili ana me ka loko ia a me ka ana Alodio o Barenaba, a e holo ma ia ana *Alodio* 44' *Alodio* 14 1/2'
Roda - alaila *Alodio* 88 1/2' *Alodio* 18 Roda, - alaila *Alodio* 52 1/2' *Alodio* 6 1/2' Roda, - alaila *Alodio* 40' *Alodio* 9 Roda
10 Kap; alaila *Alodio* 63' *Alodio* 26 Roda, - alaila *Alodio* 18 1/2' *Alodio* 13 3/4 Roda, - alaila *Alodio* 62 1/2' *Alodio* 18 Roda
alaila *Alodio* 34' *Alodio* 49 Roda a hiki i ke kua *Alodio* o keia ana, - alaila e holo *Alodio* 57 1/2' *Alodio*
2.75 Kaula a hiki i ke kua kua kua, - alaila e holo *Alodio* 19 1/2' *Alodio* 14, 83 kaula; - alaila e holo
Alodio 58 1/2' *Alodio* 25, 68 kaula a hiki i ke kua *Alodio* o keia.

Alodio o keia *Alodio* 12 1/4 Eka.

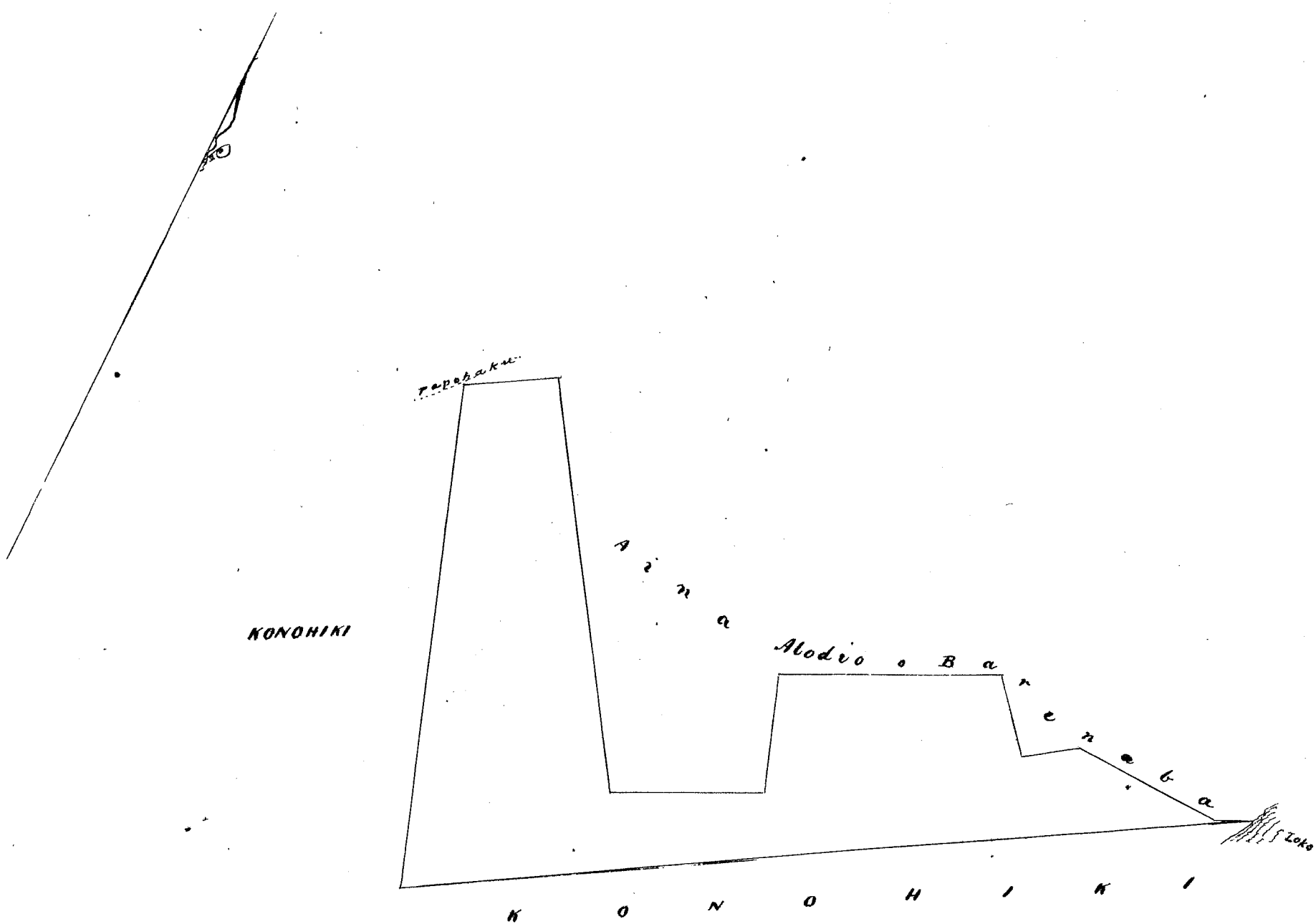

4 Chains to an Inche

Ua koi mai oia no kona wahi ma Heuho ma Kaiakea ma ka Moku o Hawaii; no ka mea, ua loa ia ia keia wahi no kona mau makua aia, a ua make ia i ka malama Aperila 1848, a o Kakaia laukana wahine ka mea e noho nei ma keia wahi a hiki i keia manawa.

Oia ka makou e hooho nei no A.B. Kaiama; he kuleana hoi kona muloto iho o ka Anu Aloha. Ima e ukui mai oia i ke ke Anu Aloha; aiaia, ua kuleana ia ia ka Palapala Aloha.

Pono nae ia ia ke ukui no ka hooholo a me ka hooholo ana i ka olelo. Penei

/\$ Kem.

No ka rumi a me ke kope ana i ka olelo ma ka Moku.

No ke kope ana i ka olelo keia

No ka palapala keia

W. L. Lee

G. M. Robertson

J. H. Smith

J. Kekaula

~~J. H. Smith~~

No ka hana ana i ka olelo 8 o Novemaba 1848.

No ke kope ana i ka olelo a ma hiki Aloha

No ke ana ana i ka olelo 19 o Novemaba 1852.

No ka kope ana

No ka hooholo ana i ka olelo Dekemaba 9, 1852.

/\$ 10.00

Eia mahele

Anua o E. M. Lyman

Kaiakea, Hele, Hawaii.

Ma ke kahi Hele o Kaiakea. E hoomaka keia ma ke kumu fenua ma ke kahi Hele o Kaiakea, a e holo Hele 5 Hele 3, 70 kaul; - aiaia He. 80° Kom. 0, 60 paku; aiaia Hele 8° Kom. 3, 00 kaul. - aiaia Hele 5° Hele 6, 57 kaul. - aiaia Hele 89° Kom. 5, 70 kaul. - aiaia Hele 59° Kom. 3, 29 kaul. a hiki i Hele o Kaiakea, - aiaia e holo ma ke kumu Hele 11 1/2° Kom. 8, 21 kaul; aiaia e holo Hele 68 1/2° Hele 11, 00 kaul. a hiki i kahi i hoomaka i.

Muloto o keia Anua 10 1/4 Eka.

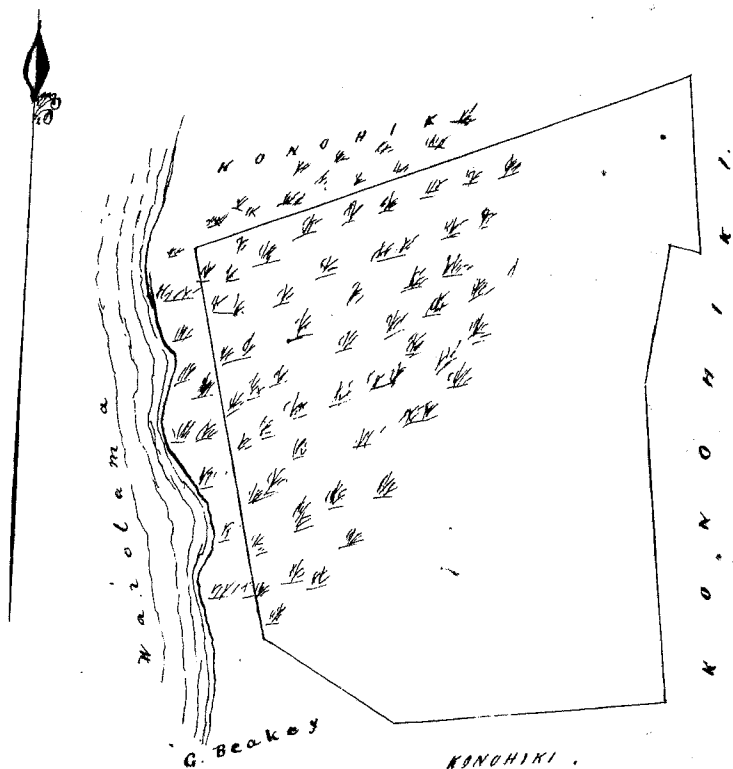

4 Chains to an Inche

Ua kōi mai oia no kona pahale ma Kapunakolo. Honolulu ma ka Mokupuni o Oahu, no ka mea, ua loaa ia ia keia wahi no Naone kona kupunawahi no i ka M. S. 1848 i ka wa o kona make ana ma ke kauoha, a ua loaa hoi ia Naone mamua loa i ka wa e ola ana o Kamehameha I, a ua noho keakea ole ia a hiki i keia manawa.

Oia ka makou e hooko nei no J. F. Manini, ke kuleana hoi kona malalo iho o ke Am Alois. Ina e ukou mai oia i ke ke Kupuni hapaha, alaila, ua kupou ia ia ka Palapala Sita Nui Am Alois.

Fono nae ia ia ke ukou no ka hookolokolo ana, a me ka hookolo ana i ka olelo, Penei;

W. L. Lee

G. M. Robertson

J. Kikaulaha

J. H. Smith

No ka rumi a me ke pui ana i ka olelo ma ka Mapepa.

No ke kope ana i na olelo koina -

No ka palapala kii -

No ka hana ana i ka la 13 o Januari 1851.

No ke kope ana i ka olelo a na huike -

No ke ana ana i ka la 21 o Aperila 1851.

No ke kope ana -

No ka hookolo ana i ka olelo - 14 Det. 1852

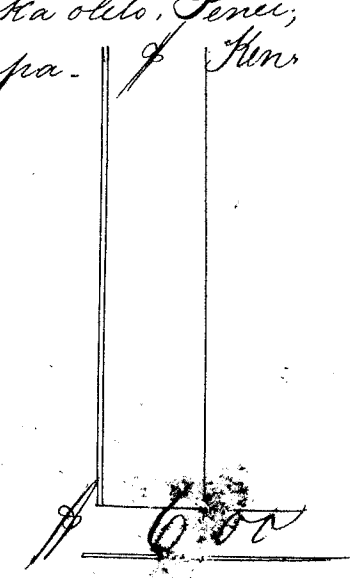

Penei ma palena.

Anaia e A. F. Sumner

Commence at North East angle and run -

- S. 61° W. 40 1/2 ft. along Akoni's land
 - S. 62° W. 16 " " Kahanaike
 - N. 40° W. 3 " " "
 - S. 62° W. 12 9/12 " " "
 - N. 31° W. 52 " " "
 - N. 55 1/2° E. 55 7/12 " " "
 - S. 28° E. 34 1/12 " " Kalua Pakohana
 - N. 65° E. 25 7/12 " " "
- to the point of Commencement Area 90 Fathoms.

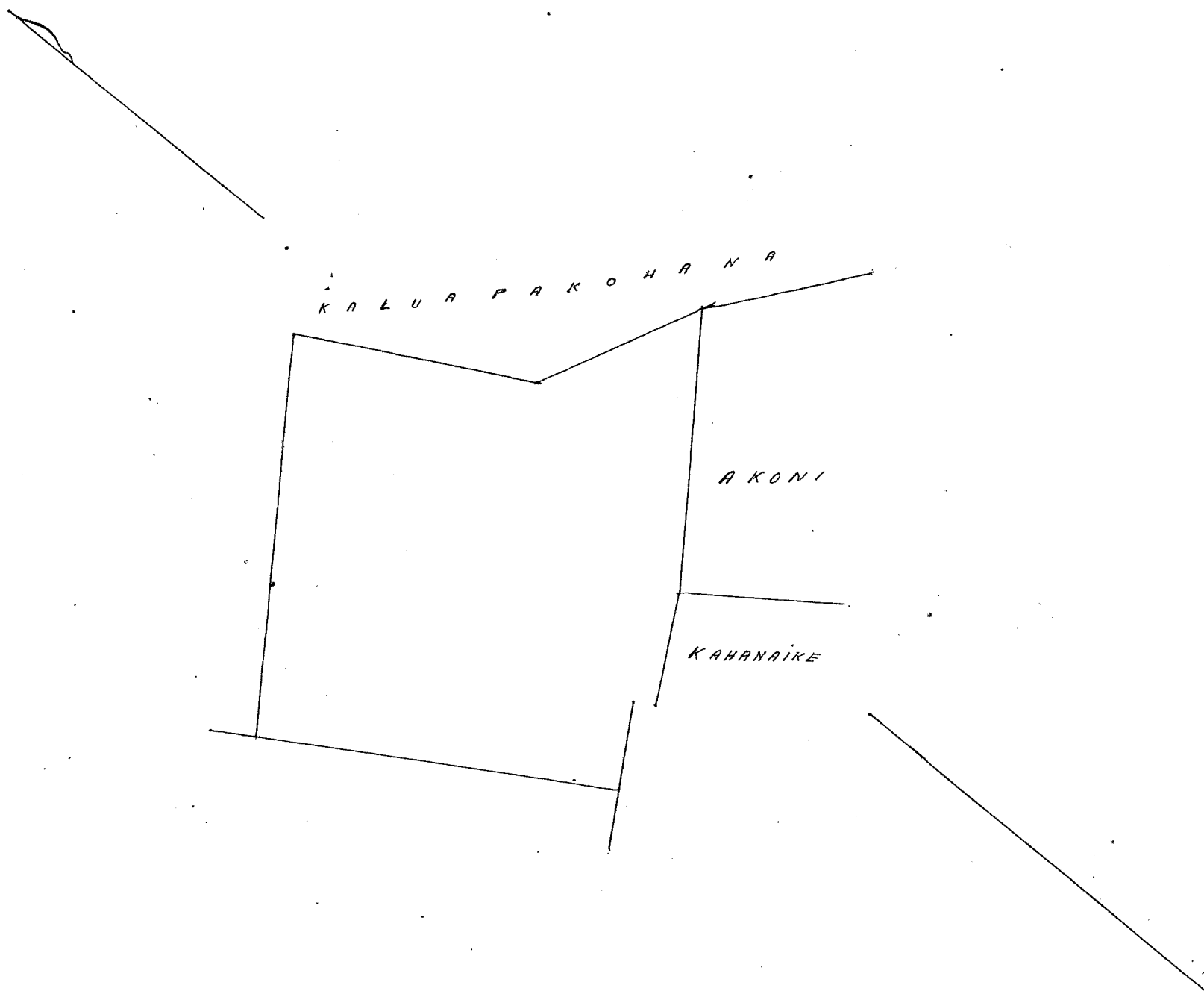

Hulu 2944 B Honi

Ua hua mai oia no kona wahi ma Kapunoko ma Honolulu, ma Kona ma ka Moku o Kapuni Oahu no ka mea, ua loa iaia keia wahi no Kamehameha I, ma kona kamaoia ana ma ka palapala i kona make ana i ka M.H. 1848, a ua loa iaia Kamehameha I ma kona kamaoia ana ma ka palapala i kona make ana i ka M.H. 1848, a ua loa iaia Kamehameha I, a ua loa iaia Kamehameha I, a ua loa iaia Kamehameha I.

Oia ka makua e hoko nei no Honi; he kuleana hui kamaoia malalo iho o ke Alo Alo. Ana e utu mai oia i ke ke Kupuni hapa; alaila, ua kupaia iaia ka Palapala o ke Alo Alo. Iono naia iaia ke utu no ka hui o ke alo a ma ka hoko ana i ka olelo. Ioni.

- W. L. Lee No ka inu a me ke pua ana i ka olelo ma ka Moku o Kapuni
- No ke kupaia ana i ka olelo kamaoia
- No ka palapala hui
- G. M. Robertson No ka hana ana i ka la 13 o Januari 1857
- J. Kaula No ke kupaia ana i ka olelo a ma ke kupaia
- J. H. Smith No ka hana ana i ka la 21 o April 1857
- No ke kupaia ana
- No ka hoko ana i ka olelo Dekemaba 14, 1852.

\$ Hon.

4000

Eia na faatena. Aniaia e A. J. Turner

House Lot at Honolulu

	Commencing at North angle and running	
S. 51° E.	34 ⁵ / ₁₂ ft	along Kalua Takohana
S. 44° W.	47 "	" Capt. Maughan's land
N. 40° W.	42 ⁶ / ₁₂ "	" Kahanaike
N. 61° E.	40 ¹ / ₁₂ "	" P. H. Manini to the point of commencement
	Area	46 ¹ / ₂ Sathons.

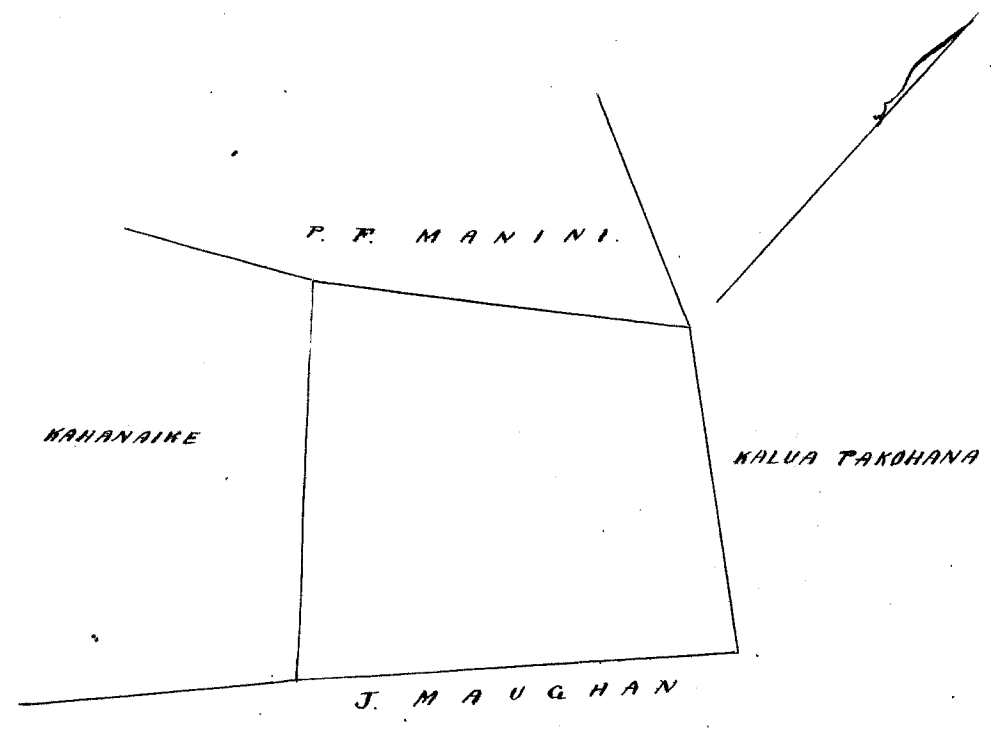

Hele 11050 B Kaehenui

Ua kōi mai oia no kona mau wahi ma Kaiākea ma Hele maika (Pūkepuni) o Hawaii; no ka mea, ua loa i oia keia mau wahi no Kapapa mai i ka M. A. 1843, a ua lohi loa no kona noho ana ma keia mau wahi, a ua noho keakea oia a hiki i keia mau wahi.

Oia ka mōkō e hōko nei no Kaehenui; ke kule ana kōi kona mānalo iho o ke Aho Alodii. Ima e uku mai oia i ke Aupuni hapaha; alaila, ua hōpuna ia ka Palapala Hele Alodii. Ima e uku ia i ke uku no ka hōhōloko. ana a me ka hōhōloko ana i ke olelo. Ima e,

- W. L. Lee No ke kōi a me ke pū ana i ke olelo maika Kapapa.
- No ke kōi ana i ke olelo kōi ana
- No ke palapala kōi
- No ke hana ana i ke ka 28 o Novemaba 1848.
- S. M. Robertson No ke kōi ana i ke olelo a me hōko
- J. Kikaulaha No ke ana ana i ke ka 16 o Sept 1852.
- J. H. Smith No ke kōi ana
- No ke hōhōloko ana i ke olelo Iekemaba 16, 1852.

\$ 800

Eia ma palena. Anaiā e H. M. Lyman

Kaiākea Hele, Hawaii.

Apana 1. E hōmaka keia ma kahi ahupehaku ma ke kōi mānalo o keia, a e holo Ma. 7 1/2 Hele. 3,00 kaul. a hiki i ke palena o Pūpio; alaila e holo ma ia palena Ma. 6 1/2 Nov. 3, 14 kaul. & Ma. 4 1/4 Nov. 10, 14 kaul. alaila e holo Ma. 7 1/2 Nov. 3, 56 kaul. alaila e holo i ke Hele. 3 3/4 Hele. 4, 60 kaul. & Hele. 5 1/2 Hele. 4, 96 kaul. a hiki i kahi kumu ulu; alaila e holo hō Hele. 9 1/2 Hele. 3, 07 kaul. & Hele. 4 1/4 Hele. 2, 30 kaul. a hiki i kahi i hōmaka 'i.

Maloko o keia Apana 4 59/100 Eia calculated by J. Waller

Apana 2. - Pūpio, Kaiākea, Hele, Hawaii.

E hōmaka keia ma kahi kumu ulu ma ke kōi mānalo o keia ma ka iwi o Pūpio ma Kaiākea, a e holo ma ke palena o ke kule ana o Kuahōpu, Hele. 5 Hele. 3, 19 kaul. & Hele. 79 3/4 Hele. 0, 71 kaul. & Hele. 3, 83 kaul. & Ma. 73 1/2 Nov. 1, 60 kaul. i ke kōi mānalo o ke Apana 1. ma ke palena o Pūpio; alaila ma ia palena Ma. 4 3/4 Hele. 6, 65 kaul. a hiki i kahi i hōmaka 'i.

Maloko o keia Apana 6/70 o keia Eka.

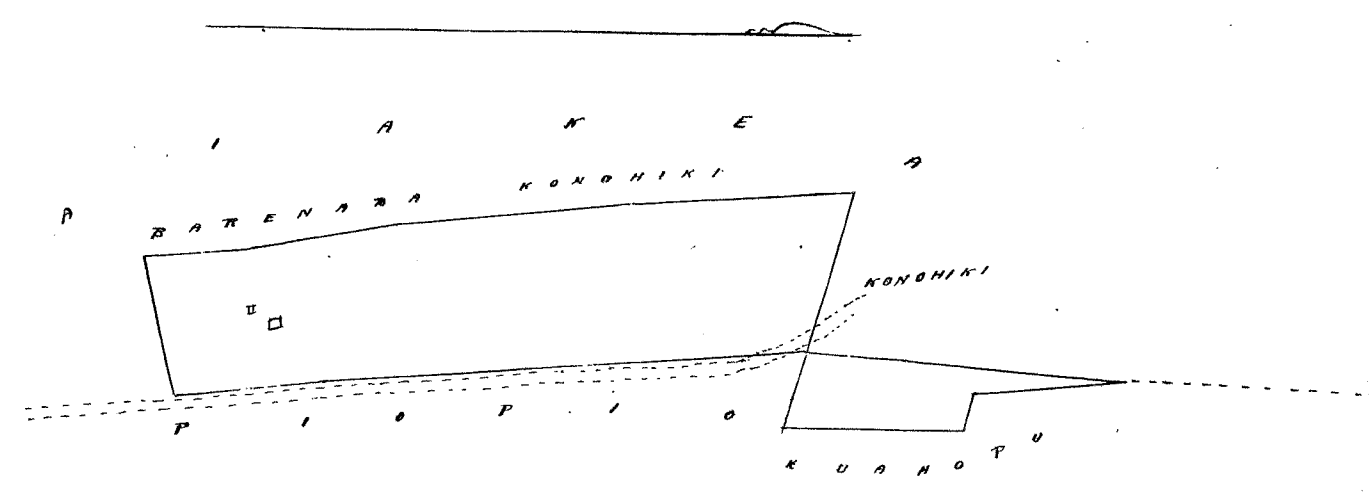

4 Chains = 1 mi.

Ua kōi mai oia no kona wahi ma Nāiaka, Hilo, ma ka Moku o Hawaii; no ka mea ua loa ia ia keia wahi no kona mau kupuna mau, a ua noho heaheha oia a hiki i keia manawa.

Oia ka maaka a hōko nei no Kapu; he kuleana kōi kona malalo iho o ke Awa-Abdū. Ma u uku mai oia i ke ke Aupuni hapaha; alaila, ua kōpuno ia ia ka Palapala Hilo

Pono mau ia ia ke uku no ka hōhōhō a me ka hōhōhō ana i keia olelo. Pono;

W. L. Lee

No ka omi a me ke pāi ana i keia olelo ma ka Muepua.

No ke kope ana i keia olelo-kōina

No ka palapala kōi

No ka hōma ana i keia 5 o Aperila 1848.

G. M. Robertson

No ke kope ana i keia olelo a ma hōke 1/2 Awa

J. Hekeaulaha

No ke ana ana i keia

J. K. Smith

No ke kope ana

No ka hōhōhō ana i keia olelo-Okemaba 16, 1852.

\$ Ken.

\$ 5.00

Oia maipalema. Anaia o E. M. Pyman.

Nāiaka, Hilo, Hawaii.

He kuleana keia ma ke hiki o Emma Kōkōina o ke kuleana o Kuahōpu, a e holo ma ia kuleana Hēm. 80. Hōm. 1, 77 kaul. a hiki i ke kuleana ana o Kalua; alaila, e holo ma ia kuleana Hēm. 8 1/2 Hōk. 6, 86 kaul. a hiki i ke loko ia; alaila ma kupa o ke loko Hēm. 74 1/2 Hōk. 2, 58 kaul. a hiki i ke papohaku mawana o ma loko; alaila e holo Hēm. 14 1/2 Hōk. 1, 80 kaul. i ke kumu ulu; alaila e holo Hēm. 20 1/4 Hōm. 5, 78 kaul. ma ke kuleana o Pūnini a hiki ma ka hōhōhō a hōhōhō i.

Maloko o keia 1/10 Eka.

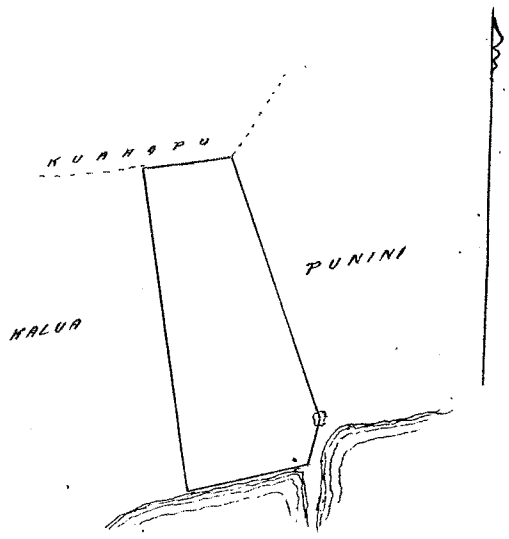

4 chains = inches

Helu 8854 Kalua.

Ua hoi mai oia no kona wahi mai Naniakea, Hilo, ma ka Mokupuni o Hawaii; no ka mea, ua loaa ia ia keia wahi no kona mau makua mai i ka manawa o Kamuekamueha I, a ua nohu kaakea oia a hiki i keia manawa.

Oia ka makou e hooke me i no Kalua; he kuleana hoi kona malalo iho o ke Aun Alodio. Ina e ikeu mai oia i ke ke Aupuni kaapapa, alaila, ua hupono ia ia ka Palapala Iho Alodio.

Penoi, mai ia ia ke ikeu no ka hooke hooke a me ka hooke ana i ka olelo. Penoi,

\$ Ken.

W. L. Lee

No ka sumi a me ke faai ana i ka olelo ma ka Nupupu

No ke kope ana i ka olelo koima.

No ka faatapala kii

G. M. Robertson

No ka hana ana i ka la 17 o Noowaba 1848

J. K. Kaulaha

No ke kope ana i na olelo a ma hoi ke 1/2 Aun.

J. H. Smith

No ka ana ana i ka la

No ke kope ana

No ka hooke ana i ka olelo Decemaba 16, 1852.

\$ 6 00

Oia ma faatena:

Anaia e H. M. Lyman

Naniakea, Hilo, Hawaii.

E hoomaka keia ma ke kii maika o ke kuleana o Kuakapu e fili ana me ke Aunui, a e holo ma ia Palena Maun 80° Hiko. 4, 89 kaul. a hiki i ke kii Hoohehona o ke kuleana o Kapu; alaila e holo ma ia kuleana Hoohehona 8 3/4 Hiko. 6, 86 kaul. a hiki i ka loko ia; alaila ma ka loko Hoohehona 47° Hoohehona 1, 75 kaul.; alaila e holo Maun 27° Hoohehona 2, 60 kaul.; alaila Hoohehona 57° Hoohehona 1, 17 kaul.; alaila Hoohehona 40 1/2 Hoohehona 3, 01 kaul. Alaila e holo Maun 3 1/2 Hoohehona 7, 60 kaul. a hiki ma ka kii e hoomaka i.

Maloko o keia 3 4/10 Eka.

4 in.

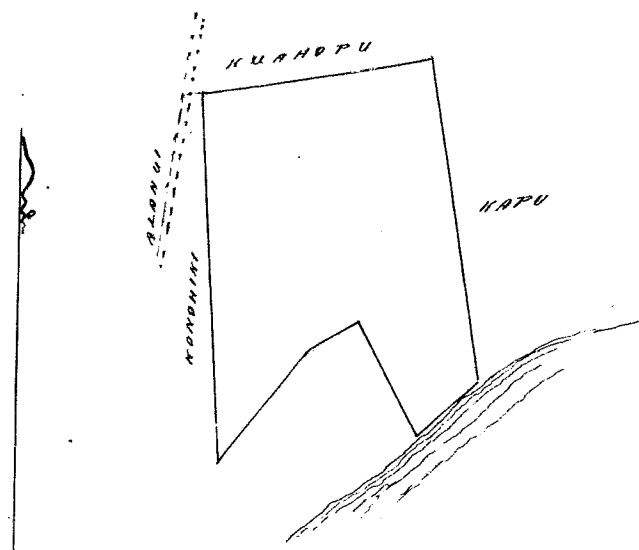

Ua kōi mai oia no kona wahi ma Kaiakoa, Hilo, ma ka Moku-o-Hawaii; aia
ka mea, ua loa ia ia keia wahi no kona mau makua mai i ka manawa o Hamakua, a ua nō
kaea oia a hiki i keia manawa.

Oia ka makua e hōkō nei no Hale, ke kulaana kōi kona malalo iho o ke Awa-
Alodiu. Ina e ukū mai oia i ke Awa-
Alodiu hupaka; alaila, ua kōpono ia ia ka Palapala Lā-
Alodiu.

Iono na ia ia ke ukū no ka hōkōloholo a me ka hōkōlo ana i ka olelo. Ionei

Ken.

No ka (name) a me ke fani ana i ka olelo ma ka Napuka
W. L. Lee. No ke kōpe ana i ka olelo kōna
No ka palapala kōi

G. M. Robertson No ka hana ana i ka lā 17 o Novemaba 1848
No ka kōpe ana i ka olelo a ma hōkō 1/2 Awa

J. Hekaulahas No ke ana ana i ka la

J. H. Smith No ke kōpe ana
No ke hōkōlo ana i ka olelo Dekemaba 16, 1852.

8 00

Eia ma palena. Anaia o G. M. Lyman

Kaiakoa, Hilo, Hawaii.

E hōmaka keia ma ka hiki fani ma ke kōi Akau o keia, a e holo Kum. 3' Horn.
1.46 kaul. a hiki i ke kōi ma ke kōi Akau o keia, a e holo Kum. 3' Horn. 1.46
ma ke palena oia kōna Kum. 78 7/4 Hiki. 10.71 kaul. a hiki i ka hiki fani fōhaku,
alaila Kum. 61 1/2 Hiki. 10.58 kaul. a hiki i ke kōi ma ke kōi Akau o keia,
alaila e holo ma ke māwae M. 7' Horn. 4, 96 kaul.; alaila e holo i ka
ma ke ana o ke kōi M. 79' Horn. 19.55 kaul. a hiki ma ke kōi i hōmaka'i.

Malolo o keia

4 1/4 Eka.

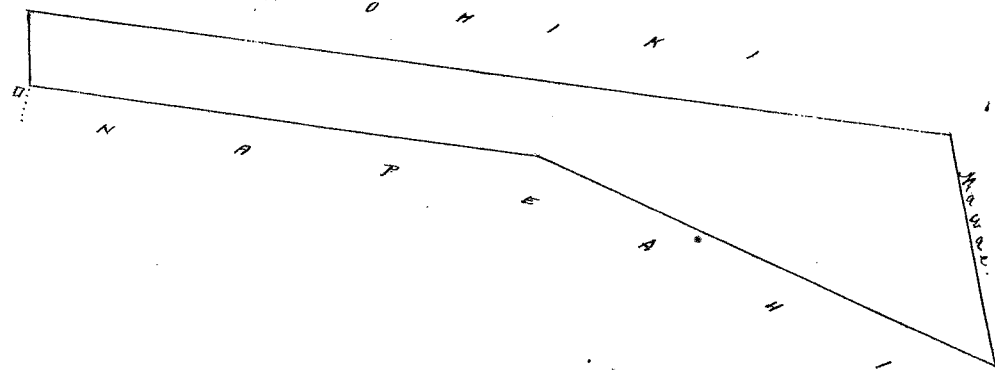

4 Eka. in

Ua kivi mai oia no kona mau wahi ma Pipio, Kaiakoa, ma Hilo ma ka Mokupuni o Hawaii; no ka mea, ua loaiaiaia keia mau wahi no kona mau kupuna mai ka Apana 1, 2, 3, 4, a no Pea, mai ka Apana 5, 6, i ka makahiki 1840, a ua noho keakea oia a hiki i keia manawa.

Oia ka makou i hoohe nei no Kuahopu; he kuleana hoi kona maalo iho o ke Aho-Moio. Ana e uku mai oia i ke ke Aupuni hapaaha; alaila ua hupono ia ia ka Palapala Lila Moio.

Iho mau ia ia ke uku no ka hoohelele a me ke hoohelele ana i ka olelo. Ima,

W. L. Lee

No ka omu a me ke pui ana i ka olelo ma ka Moiopepa.

G. M. Robertson

No ke kope ana i ka olelo-koina

J. Kekaulahao

No ka palapala kii

No ka hana ana i ka la 17 o Novemaba 1848

J. H. Smith

No ke kope ana i ka olelo a me hoi ke 1/2 Aho.

No ke ana ana i ka la

No ke kope ana

No ke hoohelele ana i ka olelo, Dekemaba 16, 1852.

\$ Rew.

\$ 12 00

Oia na palena. Anaia o H. M. Lyman

Pipio, Kaiakoa, Hilo, Hawaii.

Apana 1. — E hoomaka keia ma ke kumu ulu ma ka palena o Kaiakoa, a e holo Ma. 73 1/2 Hiki. 4, 80 kaul. a hiki i ka kumu niu; alaila Aho 72 1/2 Horn. 5, 85 kaul. a hiki i ke kuleana o Kaiakoa; alaila Horn. 1 Hiki. 3, 22 kaul. alaila Ma. 86 Hiki. 0, 96 kaul. a hiki ma ka kahi o hoomaka'i. Maloko o keia Apana 94/100 o ka Eka

Apana 2. E hoomaka keia ma ka kahi ahupuaa ma ka palena o ke Alanui ma ke kahi o Kama o keia, a e holo i ka Ma. 8 Hiki. 6, 66 kaul.; alaila Ma. 12 Hiki. 5, 43 kaul.; alaila Ma. 57 1/2 Hiki. 4, 55 kaul. alaila e holo Ma. 20 1/4 Horn. 6, 18 kaul. a hiki i ka loko; alaila e holo ma ka loko Horn. 83 Horn. 6, 17 kaul.; alaila e holo Horn. 3 Hiki. 1, 55 kaul. o Horn. 86 1/4 Horn. 3, 75 kaul. a hiki i ke kuleana o Kaiakoa; alaila e holo ma ka palena o ia kuleana Horn. 1/2 Hiki. 3, 83 kaul. o Ma. 74 1/4 Horn. 1, 60 kaul. i ke alanui; alaila e holo ana ia alanui, Horn. 6 3/4 Hiki. 8, 50 kaul. a hiki ma ka kahi o hoomaka'i. Maloko o keia Apana 19 2/10 Eka.

4 Chains = 1 Mehe

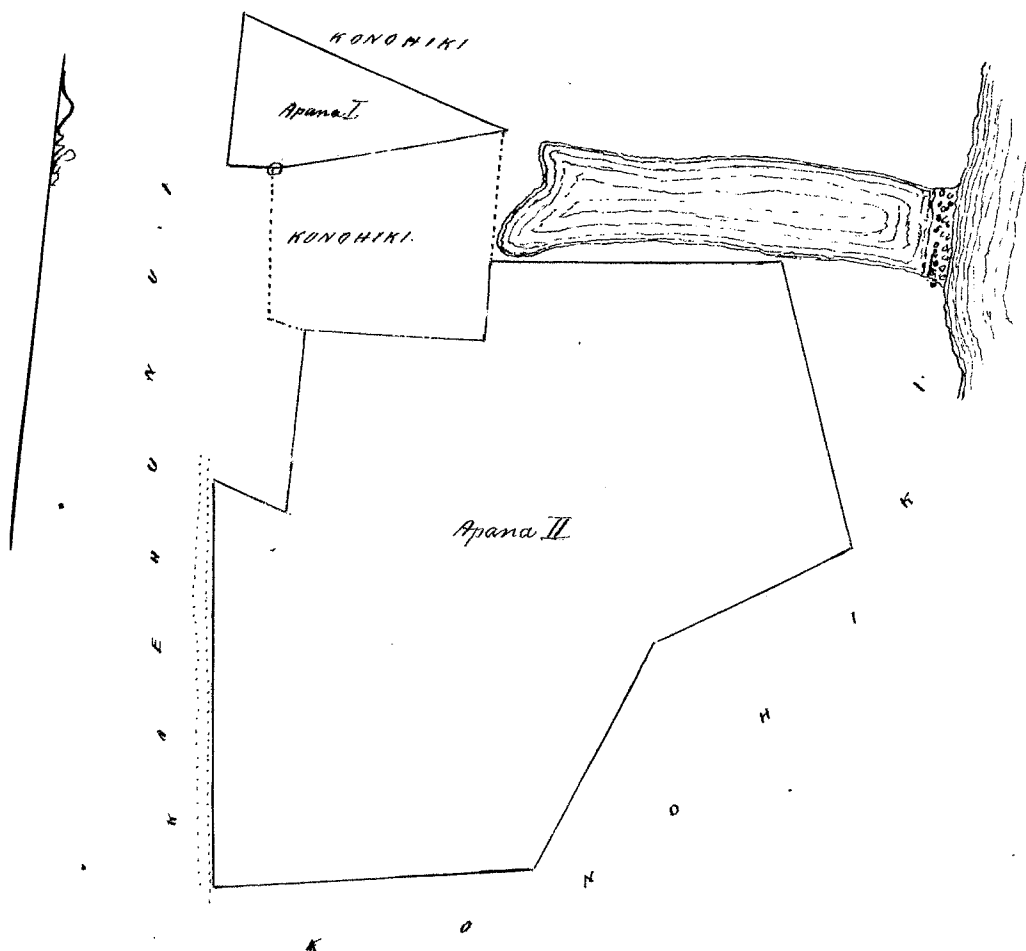

Hele 68 Kapahuanui

Ua hoi mai oia no kona wahi ma Honolulu ma kona maika (Mokupuni) o Oahu, no ka mea, ua hooia ia i keia wahi i ka Lukihi nei; he wahi waiko wale no keia, a o Kapahuanui no ka mea nana i noko keia wahi mamua, a ua noko keia oleia a hiki i keia manawa.

Oia ka makiu e hooke nei no Kapahuanui; he ka mea kuleana hoi kona malalo iho o ke Awa Alodio. Ina e uku mai oia i noko ke Aupuni kapaha; alaila, ua hooia ia ka Palapala Ika Alodio.

Pono nae ia iu ke uku no ka hookelelele a me ka hoohelelele i ka olelo. Penei

\$ Kon.

- No ka orumi a me ke fari ana i ka olelo ma ka Mohepa.
- No ke kope ana i ka olelo koina
- No ka palapala hii
- No ka hana ana i ka la 12 o Augata 1846.
- No ke kope ana i ka olelo ma keia hiki.
- No ke ana ana i ka la 25 o Iulai 1851.
- No ke kope ana
- No ka hoohelelele ana i ka olelo Iekemaba 16, 1852.

W. L. Lee
G. M. Robertson
J. Kekaulaha
J. H. Smith

\$ 500

Eia na palena. Ina e J. H. Mokalena.

Puhale ma Honolulu, Mokupuni Oahu.

E hoomaka ana ma ke kahi Kikina Maan maika o keia hoi i pili ana me ke Puaa makapa o ka muliwai Kaunakapili i ka laepaku pohaku iloko o ka muliwai Hoailonaiia X. A holo ma ke Puaa Kom. 21° 30' Kom. 700 Haul. - Kom. 31° 30' Kom. 700 Haul. - Kom. 35° Kom. 700 Haul. - Alaila hoohelelele ma 65° 30' Kom. 1 2/100 Haul. i kahi i ho-paapaaia. Iuli M. 24° Kom. 1 2/100 Haul. i ka muliwai ma ka muliwai aku M. 75° 30' Kom. 2 4/100 Haul. i kahi i hoomaka 'i.

Ma na palena 294 Anana Aue.

Olelohoakaka. Ua hoi o Iane Pi laua o J. Kekaulaha e nana a hooia i ka ho-paapaaia ana me Puaa, a ua hoohelelelele ma Luna e like me keia ana ana a J. H. Mokalena, a oia ka fari ana o ka ho-paapaaia ana i nana laua.

Iekemaba 16, 1852.

A. L. Miliili
Kakaulalo o ma Luna Arma

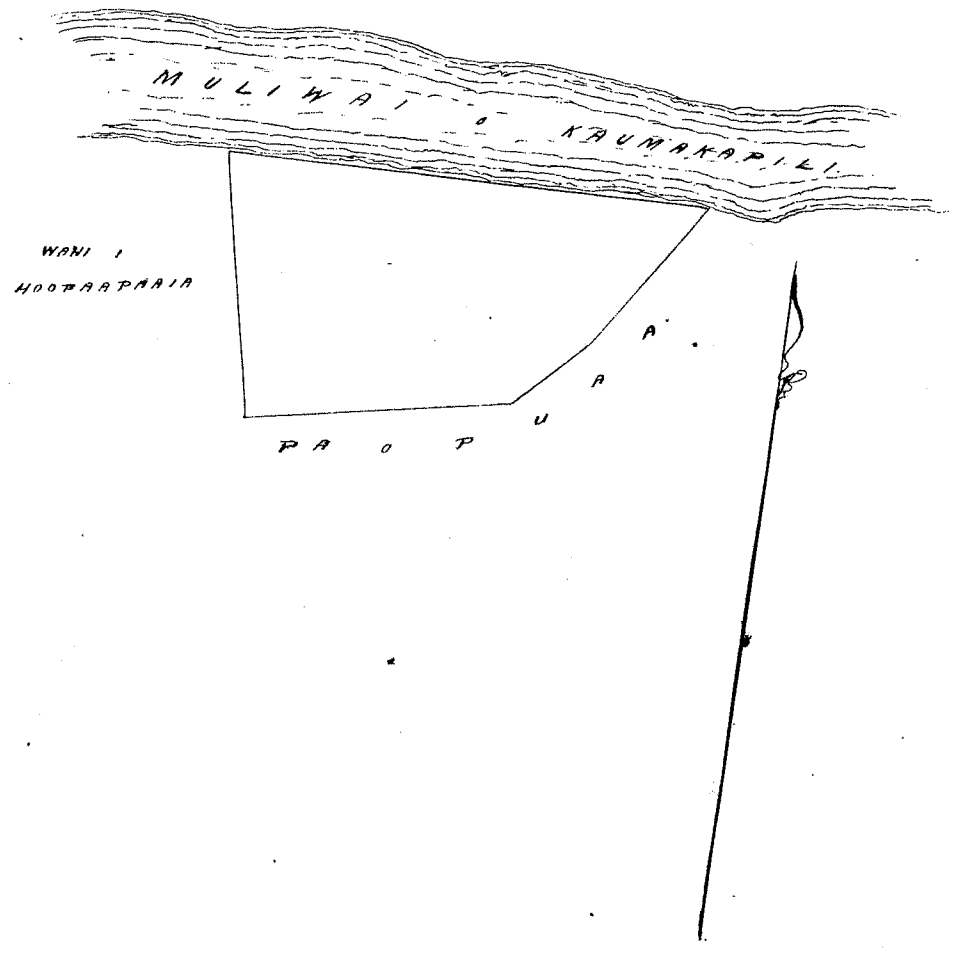

/ Kaulaha INIHA.

Helu 8547 Kaiwi (Pete Heaunani) (Kapaetea)

Ua koi mai oia no kona wahi ma Hamakua i Honolulu Aina ma Kona, ma ka Motu fumi o Oahu, no ka mea, ua lea ia ia keia wahi no Kalaoa mai kona (makaheke) i ka manawa e ola o Hinan, mamua aku i ka makahiki 1839, a ua kawai aku nei hoi oia i keia pua ia Pete Heaunani ma ka la 25 o Maraki 1849, a ua noho keakea oia a hiki i keia manawa.

Oia ka makou e hooke nei no Kaiwi; he kuluana hoi kona malalo iho o ke Aunui Alodio. Ima e, ikeu mai oia i ke ke Kapaetea, alaila, ua kupo ia ia ka Palapala Lela Alodio. Ima mai ia ia ke ikeu ma ka hookelele a me ka hookelele ana i ka olelo. Ima;

\$ Ken

- W. L. Lee No ka oromi a me ke pua ana i ka olelo ma ka Kapaetea
- No ke kope ana i ka olelo koma
- No ka palapala kii
- G. M. Robertson No ka hana ana i ka la 19 o Dekemaba 1851.
- J. H. Smith No ke kope ana i wa o lele a wa hoike 1/2 Awa
- J. Kapaetea No ke ana ana i ka la 14 o Febemari 1852.
- No ke kope ana
- No ka hookelele ana i ka olelo Dekemaba 17, 1852.

\$ 5.00

Eia ma palena. Aina o A. Heaunani

Helu 8547 Kaiwi ma Hamakua, Honolulu Aina, Kona, Oahu.
Eia palena. E hoomaka ana makou o ka puka pua Ma. 41° Kom. 89 pautu a hiki ma ka pookiwi o ka pua malalo e pili ana no mau ma ka Poo a hiki ma ka aawa e pili pua ana me ko John Stevenson, alaila huli Ma. 42° Kom. 50 pautu a hiki ma ka aawa ma ka e holo Kom. 41° Kom. 93 pautu a hiki ma ka e pili ana i ke Alani, o Kapaetea ma mea malaila a hiki i ke Alani; huli Kom. 45° Kom. 50 pautu a hiki i ka i hoomaka ana.

Maloko oia Pahale 7 Roda 28/100

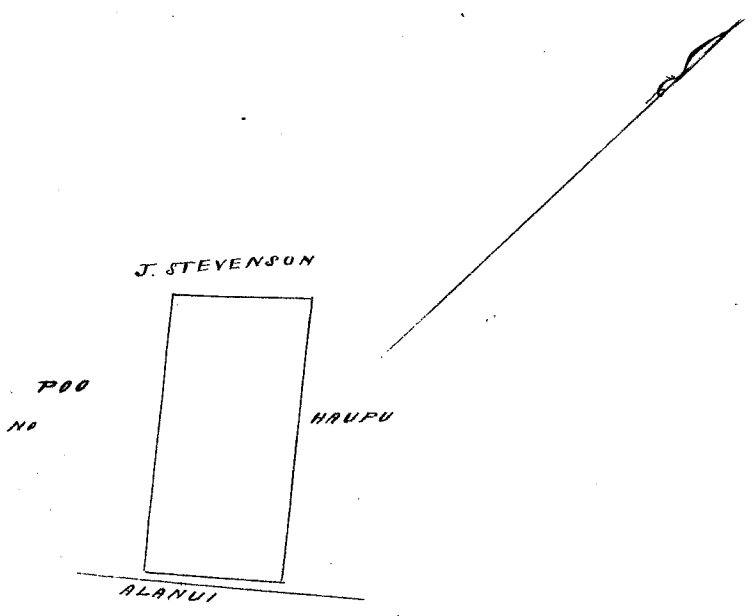

3/4 INIHA - 50 PAUKU

Ua koi mai oia no kona mau wahi, ma Kalia a me Kaakopua i Honolulu, ma Hona, ma
 ka Mokupuni o Oahu; no ka mea, ua loaia ia ia keia mau wahi no Punahaole mai kana kame i ka wa
 no e noho ana o Poku, a ua loaia hoi ia Punahaole no Poku mai, a ua noho keakea oia o Makalawelawe
 a hiki i keia manawa.

Oia ka makemake e hoko nei no Makalawelawe; he kulevana hoi kona malalo iho o ke Awa Alodii.
 Ima e ukui mai oia i ke ke Kupuni hapaha; alaila, ua kulevana ia ia ka Palapala Ika, Alodii.
 Ima mai ia ia ke ukui no ka hoko kolo a me ka hoko ana i ka olelo. Ima,

- W. L. Lee No ka omi a me ke pui ana i ka olelo, ma ka Muepua.
- No ke kope ana i ka olelo kama
- No ka palapala kii
- G. M. Robertson No ka kama ana i ka la 12 o Novemaba 1847
- J. Kekaulaheo No ke kope ana i ka olelo a ma hoi
- J. H. Smith No ke ana ana i ka la 24 o May 1851.
- No ke kope ana
- No ka hoko ana i ka olelo Dekemaba 17, 1852.

Ken.

7 05

Oia na palena. Imaia e A. J. Sumner

Spana 1. 4 Loi o Awa ma Kalia, Honolulu. E hoomaka ana ma ke kiki Hema
 a holo ana Maun 30 1/2 Komohana 83 fauku e pili ana i ke Puihii.

Maun 28 1/4	Hikina	210	"	"	"	Kaawa
Maun 43 1/2	Hikina	80	"	"	"	"
Hema 85	Hikina	133	"	"	"	Muna
Hema 6	Hikina	75	"	"	"	"
Hema 78	Komohana	44	"	"	"	Kaawa
Hema 19	Komohana	34	"	"	"	"
Hema 43	Komohana	260	"	"	"	"
			37	"	Eka	"

a hiki i kahi i hoomaka i.

Spana 2. 2 Loi ma Kaakopua, Honolulu. E hoomaka ana ma ke kiki Oahu, a holo
 Hema 39° Hikina 317 fauku e pili ana i ke Kealohipali

Hema 61 1/2	Komohana	75	"	"	"	Muna
Maun 40	Komohana	120	"	"	"	Hiluaue
Hema 6 1/2	Komohana	63	"	"	"	"
Maun 43	Komohana	155	"	"	"	Hakane
Maun 47	Hikina	150 1/2	"	"	"	Hiluaue
			75	"	Eka	"

a hiki i kahi i hoomaka i.

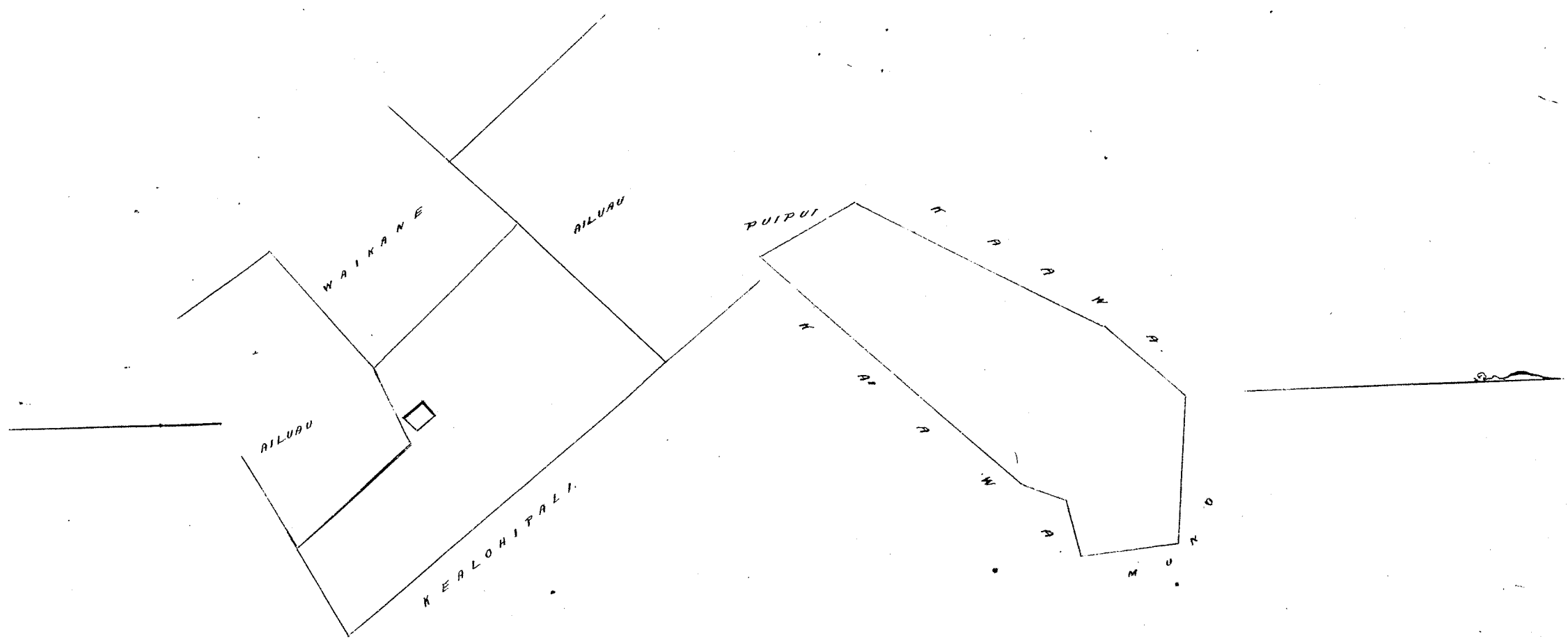

Hele 6506 Ahi (Pake)

aliu...

Ua koi mai oia no kona pahale ma Honolulu, ma Kona, ma ka Mokupuni o Oahu; no ka mea, ua loa ia ia keia pahale no Kamehameha III mai ke Alii i ka makahiki 1836, a ua noho keakea oleia a hiki i keia manawa.

Oia ka makou a hooko mai no Ahi; ke kuleana hoi kona malalo iho o ke Ano-Abdio. Ina e uku mai oia i ke ke Aiepuni hapaaka; alaila ua kupo no ia ia ka Palapala Iliu Abdio.

Tou mai ia ia ke uku no ka hookoloho a me ka hookolo ana i ka olelo. Puni.

Ken.

W. L. Lee

No ka rami a me ke fua ana i ka olelo ma ka Mupua.

No ka kope ana i ka olelo koina.

No ka palapala kii

G. M. Robertson

No ka hana ana i ka law 4, 2 Novemaba 1852.

J. K. Kaulaha

No ke kope ana i ma olelo a ma hooke 13 Aho.

V. H. Smith

No ke ana ana i ka law 30 o Novemaba 1852.

No ke kope ana

No ka hookolo ana i ka olelo Dekemaba 18, 1852.

7 00

Eia ma palena. Ania e S. Kalama.

Heleama Pahale o Ahi Pake ma Honolulu, (Kulawakaahale) Oahu.

E hoomaka ma ke kiki Ahi o keia Pahale e fili ana, me ke M. Kaina fua, a me ke kiki Kikina mauka o ka Pahale i oleloia no M. Kewanana, a e holo i ka Kema 41° 50' 3/2 Kapua e fili ana me ke M. Kaina a hiki i ka kiki Ahi o ke Alanui Kea, - Alaila Kema 40° 30' Kona 2 1/2 Kaulaha mauka i ka Ahi o ia Alanui a hiki i ka kiki mauka o ke Alanui Alii Kaina, ke kiki Kema o keia Pahale, - Alaila Ahi 48° 30' Kona 96 1/2 Kapua ma ka kiki mauka o ia Alanui a hiki i ke M. Kewanana fua, - Alaila Ahi 57° 45' Kik. 2 Kaulaha 29 3/2 Kapua ma ia fua a hiki i ka kiki i hoomaka i.

Ma M. Maloko

312 5/8 Aniani.

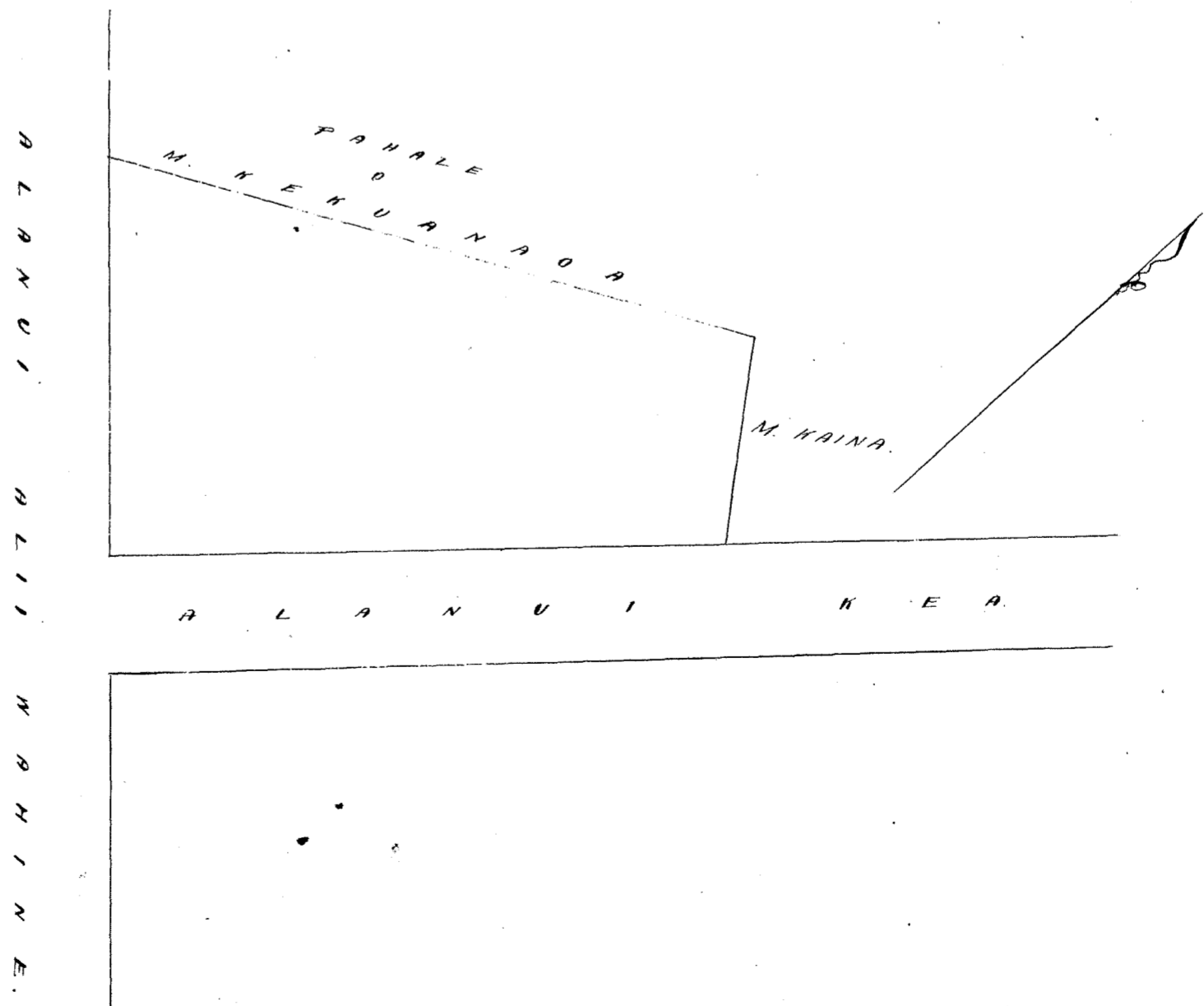

Ua koi mai oia no kona wahi ma Keonela, ma Honolulu ma Kona, ma ka Mokupuni o Oahu; no ka mea, ua lawai ia ia kua wahi no Kalaniana'olaha mai ma ka wa no e ole ana o Kimoa mamua ahu o kona make ana i ka makahiki 1839, a iwa noho kua kua oleia a hiki i keia manawa.

Oia ka makua e ho'oko nei no Hakui; he kuleana hoi kona mahalo iho o ke Aho Aloha. Ima e uku mai oia i ke ke Aupuni kapahe; alaila, ua kupa ia ia ka Palapala Iliu Aloha.

Pono mai ia ia ke uku no ka ho'okoholo a me ka ho'oholo ana i ka olelo o Penei,

- W. L. Lee No ka umi a me ka pua ana i ka olelo mai ka Mupua
- No ke kope ana i ka olelo koina ma
- No ka palapala hoi
- No ka hana ana i ka la 16 o Ianuari 1852.
- G. M. Robertson No ke kope ana i na olelo a ma hoi ke 4
- No ke ana ana i ka la 19 o Feburuari 1852.
- J. S. Kaulahao No ke kope ana
- J. H. Smith No ka ho'oholo ana i ka olelo Dekemaba 18, 1852.

\$ \$
\$ 5.00

Eia na palena. Anaia o J. Kama

Helu 2039 Hakui ma Keonela, Honolulu ma Kona, Oahu.

Ho'okahi Apana. - 5 Poi a me Kahawai. E ho'omaka ana ma ke kahi Kama Kikina ma ka aor e fili ana me Konoiki maikai, i holo ana i ka

Mau	35°	Hom.	3.53	Kaul.	e fili ana me	Konoiki
Mau	37°	Hik.	1.17	"	"	Kauwe
Kama	39½°	Hik.	.12	pa'au	"	Kaholoa
Mau	53°	Hik.	.77	"	"	"
Kama	34°	Hik.	3.37	Kaul.	"	Konoiki
Kama	42°	Hom.	2.00	"	"	Lai a me Kahana
Kama	42°	Hom.	80	pa'au	"	Kahana

a hiki i kahi i ho'omaka ai.

2 Puda 23 Puda

Olelo haka. Ona hua olelo i holoia maluna, ma holoia no ke ana hua ana o J. Kama, a ua kopeia mamuli o ia ana; Aka, no ka hua oia ana ana, nolaila ua holoia, a o ka moe ana Kama 42° Hom. 2.00 Kaul. oia ka pololei loa, ua fili ia aor ia Lai a me Kahana.

J. L. Naitili.
Kakawole o na Lina

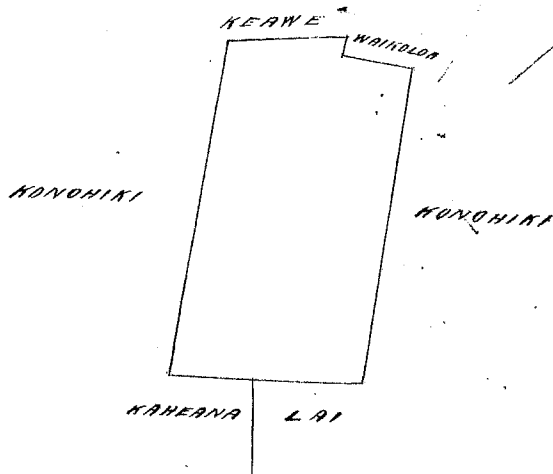

2 Kaulahao = 1 Incha

Helu 3272 Leoiki

Ua koi mai oia no kona wahi ma Kalaupapane i Honolulu, ma Kona, ma ka Motupuni o Oahu; no ka mea, ua lona ia ia keia aia no Kalaupapane ma i ka makahiki 1840, a i kona make ana i ka makahiki 1848, ua hoili i keia mau wahi no kona keiki o William Buckle, ua moho keakea oia a hiki i keia manawa.

Oia ka makou i hooko mai no Leoiki; ke kuleana hoi i kona, malalo iho o ke Ano Alodi. Aia e uku mai oia iho ke Aupuni hapaha; aiaia, ua kupaia ia ia ka Palapala Sita Alodi. Pono ma ia ia ke uku no ka hooko loko a me ka hooko ana i ka olelo. Penei,

- W. L. Lee No ka oomi a me ke puai ana i ka olelo ma ka Muepua. \$ Ken.
- No ke kope ana i ka olelo koina
- No ka palapala hoi
- G. M. Robertson No ka hana ana i ka la 15 o Ianuari 1852.
- J. Sekaulaha No ka kope ana i ma olelo a ma hoi ke 1/2 oia
- J. H. Smith No ke ana ana i ka la 1 o Dekemaba 1852.
- No ke kope ana
- No ka hooko ana i ka olelo ma ka la 18 o Dekemaba 1852.

\$ 7.00

Eia ma palena. Aiaia o S. Kalama.

Aia ma Kalaupapane, Honolulu, Oahu.

7 Lo'i. E hoomaka ma ke kiki Komohana, Akau (maka o keia aia, ma ka auwai, a me ke kiki Akau ma ka o kekehi Koele i kupaia o "Kauhina" ka inoa, e fidi ana ma ka aia o George Wood, a i holo i ka Akau 41° Hiki. 47 Panku, a me Akau 53° Hiki. 1sto Kaul. ma ka auwai i fidi ana me ke Ala olelo ma ka palena o ka aia o George Wood a hiki i ka aia o ke Komohiki o Levi Hoalelea, - Alaia holo i ka Kona, 44° 3/4 Hiki. 1sto Kaul. a me Kona 47° Hiki. 93 Panku, a me Kona 55° Hiki. 1sto Kaul. ma ke L. Hoalelea a hiki i ka auwai i fidi ana me Kalaupapane, - Alaia Kona 18° 30' Kom. 65 Panku a me Kona 2° Kom. 1sto Kaul. ma ka auwai me ke Kalaupapane aia, - Alaia Kona 42° 15' Kom. 1sto Kaul. ma ka auwai Komohana o ma auwai eia i koke i ka aia o Akoni a hiki i ke kuleana o Muna: ma Kaha, - Alaia Akau 40° Kom. 1sto Kaul. ma ke Muna a hiki i ke kiki Kona o ke Koele "Kauhina"; - Alaia Akau 54° Hiki. 75 Panku a me Akau 55° Hiki. 80 Panku ma ka auwai me ke Koele a hiki i ke kiki Kona ma ka o keia koele, a i ka Akau 52° Kom. 4tho Kaulaha ma ka Koele a hiki i ka kiki ihoomaka i.

795/1000 Eka.

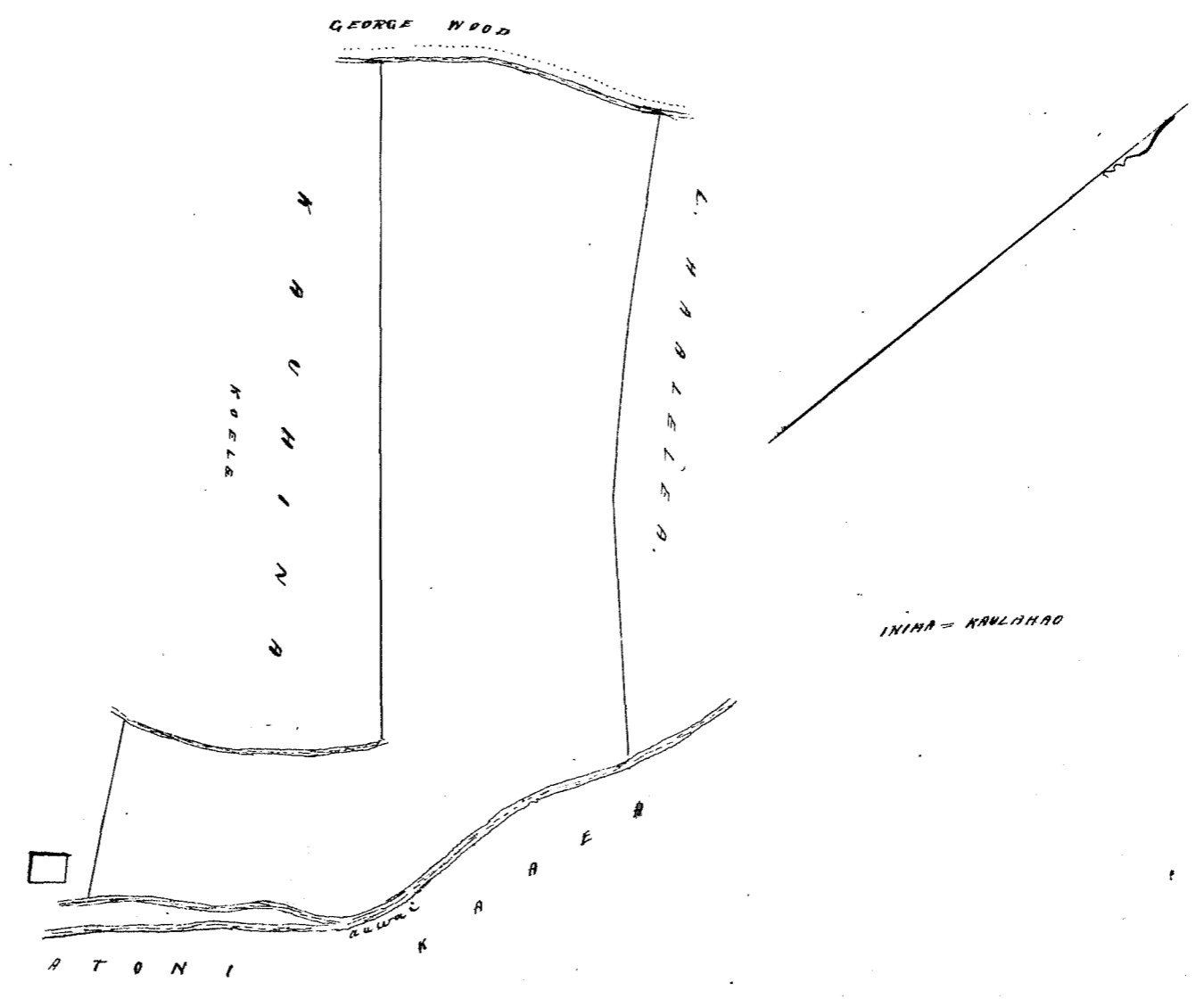

Ua koi mai oia no kona mau wahi ma Halekane a me Kuemieni i Hauula ma
Lahaina, ma ka hookupuni o Maui; no ka mea, ua laa ia ia keia mau wahi no C. Maa, Halua
a me Haleiupu mai, a ua noho keakea oia a hiki i keia manawa.

Oia ke makou e hooko-ni no Kaaitau; he kuleana hoi kono, malalo iho o ke Ano-Atodiu. Ima e
ukuu mai oia i ke ke Aupuni hapakau; alaila, ua hooko ia ia ke Palapala Sila Atodiu.

Iono naia ia ke ukuu no ka hookoholo a me ka hookoholo ana i ka olelo. Penei

\$ Hon.

W. L. Lee

No ka ruini a me ke pai ana i ka olelo ma ka Nupuan.

No ke kope ana i ka olelo hoia

No ka palapala kii

No ka hana ana i ka la 6 o Iune 1849.

No ke kope ana i na olelo a mahi ike 1/2 Awar

G. M. Robertson

No ke ana ana i ka la.

Ukui ke ana \$3.00

J. Kekaulaha

No ke kope ana

J. H. Smith

No ka hookoholo ana i ka olelo ma ka la 23, Dekemaba 1852.

\$ 5.00

Oia na palenai. Anaia e W. J. Alexander

Aia kona kuleana ma ke Aupuni a Hauula ma ka ili o Halekane kekahi Apuna,
a ma ka ili o Kuemieni kekahi, ma ka Halua o Lahaina i Maui.

Apuna 1. Ma ka ili o Halekane. E hooko ana ma ke kahi Akau Komohana, a hoi
ana

Mau	87°	Hikina	1.10	Kaula e pili ana me Oumi	
Hema	13°	Hikina	1.12	"	Kaowao
Hema	12°	Hikina	0.65	"	"
Hema	86 1/2°	Komohana	0.27	"	Kaowao
Mau	2°	Komohana	0.57	"	Kaowao
Mau	81 1/2°	Komohana	0.44	"	"
Mau	36 3/4°	Komohana	1.39	"	" i kahi i hoomaka ai.

Ma Ili Umikumamaima mau Roda.

Apuna 2. Aia ma ka ili o Kuemieni. E hooko ana ma ke kahi Hema Hikina,
a hoi ana

Mau	6 1/4°	Hikina	0.96	Kaula e pili ana me ka Kekahiko	
Hema	89 1/4°	Komohana	1.42	"	Halua & Kaowao
Mau	20°	Komohana	0.56	"	Kaowao
Hema	85 1/2°	Komohana	1.67	"	"
Hema	11 1/4°	Hikina	1.06	"	Komoha
Hema	86 1/4°	Hikina	2.96	"	Haiakohoku

i kahi i hoomaka ai. Ma Ili Hookahi Roda & Umikumamaima Roda.

35
18
212
173.25
15
1.11

1817 19

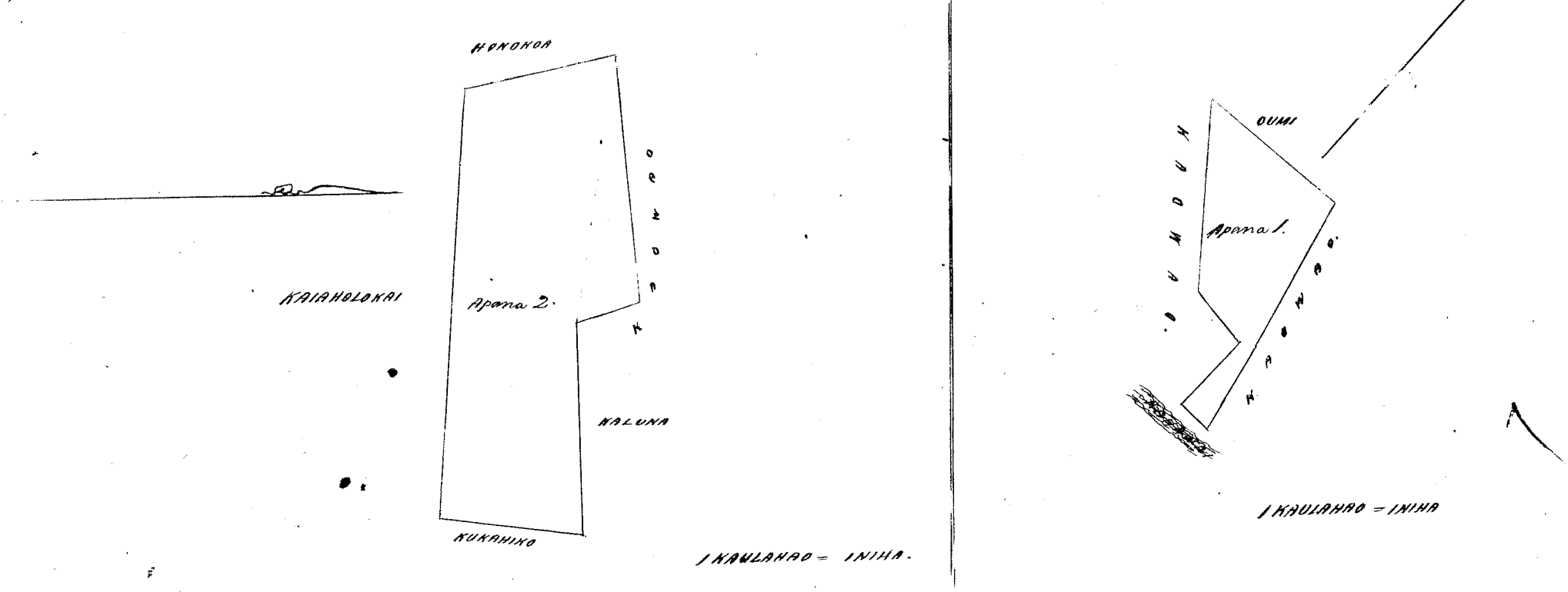

Helu 4878 B (Naopala (no Kapili))

Part 14.

Ua hoi mai oia no kona mau wahi ma Pehushuiki ma Lahaina ma ka Mokupuni o Maui, no ka mea, ua loa ia ia keia mau wahi no Puipui mai i ka makahiki 1835, a ua aho keakea oia i hiki i keia manawa.

Oia ka makoua hookonei no Naopala, he kuleana hoi kona maalo iho o ke Ano Alodio. Aua e uku oia i ka ke Auipuni huapaha, a uita, ua kupaono ia ia ka Palapala Iha Alodio. Ano meiaia ke uku no ka hookoholo a me ka hookoholo ana i ka olelo. Penei.

W. L. Lee

No ka sumi a me ke hoi ana i ka olelo ma ka Naupapa.
No ke kope ana i ka olelo koina
No ka palapala hoi

G. M. Robertson

No ka hana ana i ka ka 1 o Iune 1849.
No ke kope ana i ka olelo a ma hoi ke 13 Iune

J. H. Kaulahao

No ke ana ana i ka ka No ke ana ana \$3.00

J. H. Smith

No ke kope ana No ka hookoholo ana i ka olelo ma ka ka 23 o Iepunaha 1852.

\$ Ken.

\$ 5.00

Eia na palena. Auaia e W. J. Alexander

Naopala Helu 4878 B. Ua mahe o Naopala, a o Kapili kona hookole. Aia kona ana kuleana ma ka Auipuni o Pehushuiki ma Lahaina, Maui, Eua mau mahele.

§ 1. E hoomaka ana ma ke kahi Mahe Komohana, a e holo ana

He. 26 1/2	He. 1.53	Kaul. e pili ana me ke Kahulani
A. 68 1/4	He. 0.51	" " Laahili
A. 21 3/4	He. 1.44	" " " "
He. 74 1/2	He. 0.63	" " " i kahi hoomaka ai

Ka Ki

Umikumamakole Roda

§ 2. E hoomaka ana ma ke kahi Mahe Kauhane, a e holo ana

A. 22 3/4	He. 1.18	Kaul. e pili ana me Kahulani
He. 72 1/2	He. 0.65	" " Laahili
A. 23 1/2	He. 4.80	" " " "
He. 68 1/2	He. 1.17	" " Kauhane
He. 27 1/2	He. 6.42	" " Kuli
A. 54	He. 1.36	" " " i kahi i hoomaka ai.

Ka Ki

Hookahi Roda & Komaokohukumamao Roda

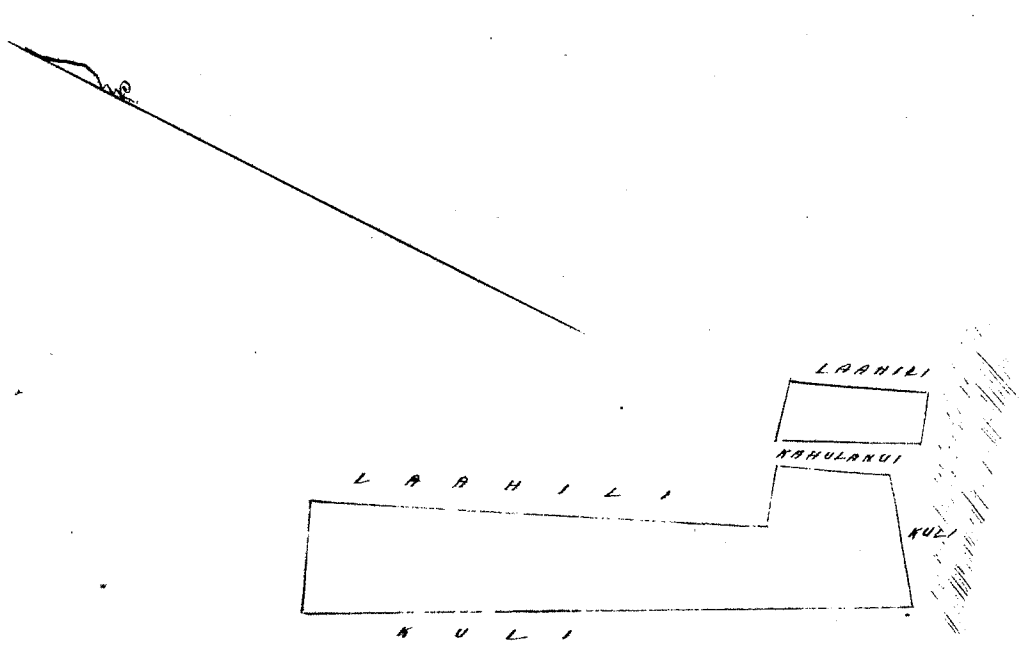

2 KAULAHAO = INIHA.

Ua koi mai oia no kona mau wahi ma Kewalo a me Auwailimu i Honolulu ma Hona, ma ka Mokupuni o Awaiki Oahu; no ka mea, ua loaa ia ia keia mau wahi no Kekuanawa a me Koghumanu mai. No Kekuanawa mai ka Apana 1, he kahakala, i ka manawa o ka hamaele a Kaomi, a no Koghumanu mai ka Apana 2, 3, i konu wa no e ola ana, a ua noho kekua oleia a hiki i keia manawa.

Oia ka makou i hooko mai ng Makina, he kuleana hoi kona malalo iho o ke au Alodia Ima e uku mai oia i ke ke Kupuni Kapaha, alaila, ua kupaia ia ia ka Palapala Lilo Alodia. Iono mau ia ia ke uku no ka hookolokolo a me ka hookolo ana i ke olelo. Ima,

- W. L. Lee No ka omu a me kei faai ana i ke olelo ma ka Kupuni
- G. M. Robertson No ke kope ana i ke olelo koina
- J. H. Smith No ka palapala hii
- J. K. Kaula No ka hana ana i ka la 26 o Dekemaba 1850.
- J. K. Kaula No ke kope ana i ke olelo a me kei kope 1 Awa
- J. K. Kaula No ka ana ana i ke la 6 Dekemaba 1852
- J. K. Kaula No ke kope ana
- J. K. Kaula No ka hookolo ana i ke olelo ma ka la 14, o Ianuari 1853.

Hem
10 00

Oia na palena. Apana o S. Kalama

Apana 1. Pahale ma Auwailimu
E hoomaka ma ka pohaku i hwaionaa x ma ka lihi mauka o ke Kahawai o Paua, i fili ana me ke Kahawai. A e holo Akau 31 1/2 Sik. 108 Kap. moke ka faa ana a hiki i ke pohaku x kokoke i Kahumanu o Kalawaa, amakee, a Akau 42 Sik. 90 Kap. ma ka Pahale o Kalawaa ia mau aaw a hiki i ke B i Kahawai i fili ana me ke Lima, ke hiki i ke mauka o keia, - Alaila Akau 25 Norm. 63 Kap. ma ke Lima a hiki i ke hiki Norm. mauka o keia i fili ana me ke ala olelo o ke Hale Hula, - Alaila Hema 84 Norm. 192 1/2 Kap. a hiki i ke pohaku x ma ka anahua o keia, a Hema 75 1/2 Norm. 52 Kap. a hiki i ke pohaku x ma ka anahua, a Hema 70 Norm. (ma 90 Kap. ^{neece line Ak} m. S. A. 2 Kap. anahua mawaho o ke faa) 150 Kap. ma ka lihi Hema o ke ala olelo ia mau aaw a hiki i ke pohaku i faai x ma ka aaw mauka o ke ala Kapaunahou ma ka fuka. Alaila Hema 73 1/2 Sik. 120 Kap. ma ka aaw malalo o ke faa a hiki i ke pohaku x, a Hema 29 Norm. 41 Kap. ma ke. Kewalo a me Auwailimu a hiki i ke hwaionaa x ma ka lihi mauka o ke Kahawai, - Alaila holo i ke ma ka lihi Akau o ke Kahawai a hiki i ke hwaionaa x ma ka lihi mauka o ke Kahawai. 18ka 145 Amana.

Apana 2. Aina Hala a me Hula ma Kewalo.
E hoomaka ma ke hiki Hema o ke Loi Hala o J. Pickett, he hiki i ke mauka o keia aaw, A e holo Akau 49 Norm. 166 Kap. ma ka hana mawaho o ke hola a hiki i ke pohaku i faai x i fili ana me ke Kahawai, - Alaila Hema 36 Norm. 52 Kap. hiki o Kalawaa, a Akau 50 Norm. 38 Kap. anahua, a Ak. 49 Norm. 146 Kap. ma ke Kalawaa ia mau aaw a hiki i ke Kahawai, Alaila Hema 46 Norm. 72 Kap. ma ke Kahawai a hiki i ke Kalawaa, - Alaila ma ia aina Hema 43 1/4 Sik. 284 Kap. a hiki i ke pohaku ma ke ala lihi i fili ana me ke mokupuni o Kewalo a me Auwailimu. Malaila aaw pololei i ke fili ana me ke aaw o ke Hula a hiki i ke hwaionaa x ma ka lihi mauka o ke Kahawai. 872 Amana.

Apana 3. Ka lua o ke Aina Hala ma Kewalo.
E hoomaka ma ka lua o ke laau no ke palena o ke Naone aaw, a e holo Akau 47 Norm. 79 Kap. a Akau 37 15 Sik. 22 Kap. a Ak. 16 No. 59 Kap. ma ke Naone a me Pooke a hiki i ke hola, - Alaila Akau 63 1/4 Sik. 62 Kap. a Ak. 11 1/2 Sik. 20 Kap. a Ak. 27 No. 100 Kap. a He. 79 1/2 No. 53 Kap. ma ia hola a hiki i ke hiki aina o Pooke, - Alaila Akau 32 Norm. 56 Kap. ma ke Pooke a me ke Hula a hiki i ke paku malalo o ke ala, Alaila Akau 55 1/2 Sik. 190 Kap. ma ke aina Hula me Konoehiki a hiki i ke J. Booth, - Alaila 31 Sik. 108 Kap. ma ke Booth a me Puumai a hiki i ke auwai, - Alaila Hema 68 Norm. 39 Kap. a He. 24 Sik. 85 Kap. hiki, a neece kupaia Lima Hema 44 Kap. hiki, a He. 36 Sik. 121 Kap. ma ke Kikau, Malalo, a me Konoehiki. Alaila Hema 50 No. 209 Kap. ma ke aina o ke Konoehiki a hiki i ke hwaionaa x ma ka lihi mauka o ke Kahawai. 18ka 415 Amana 12 Kap. ma.

Honolulu, (Dekemaba) 1852. S. Kalama

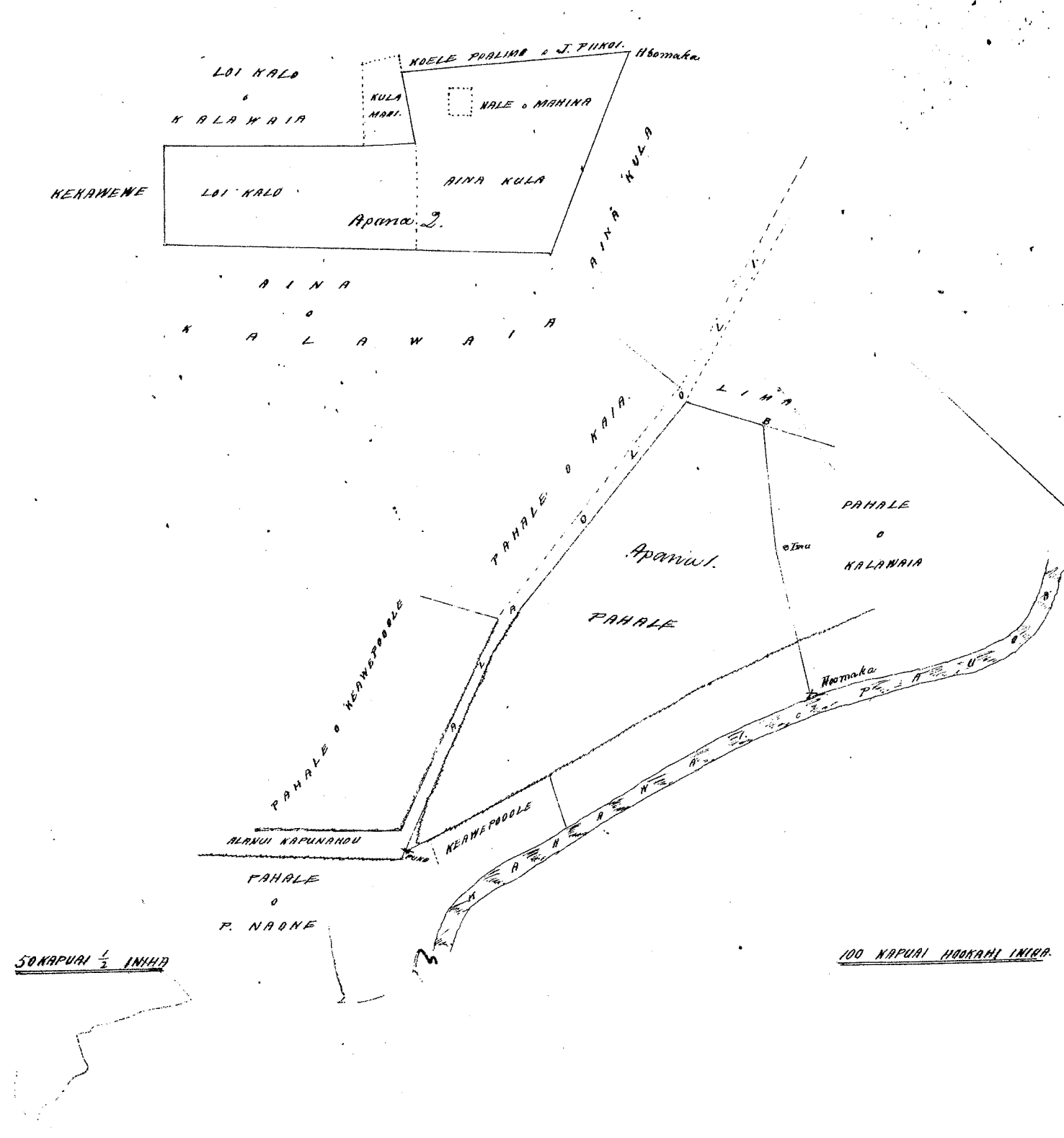
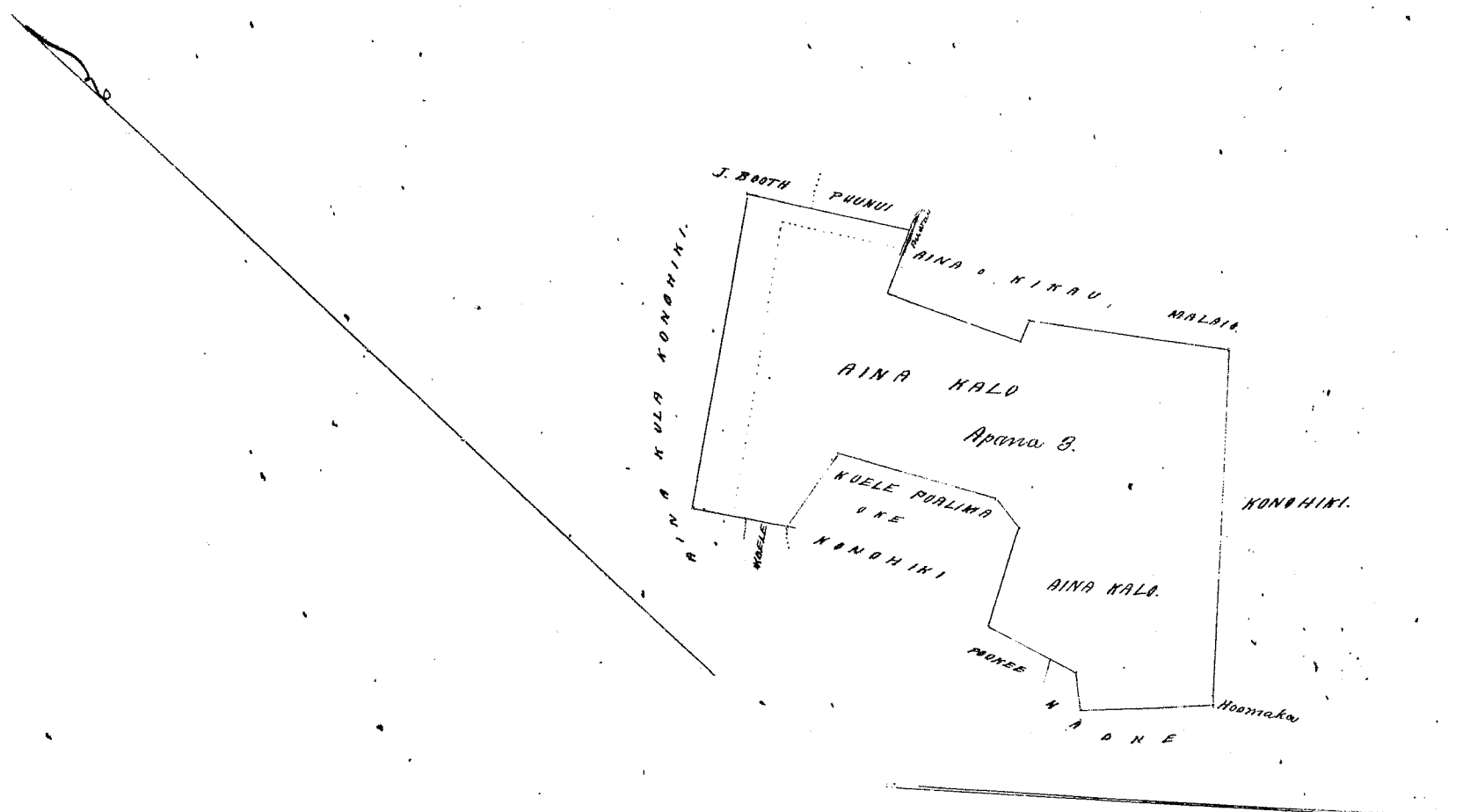

Hulu 2937 Apana 8. William Harbottle.

Ua hoi mai oia ni hona aina o Kaihia Komohana mai Kamakualoa, Moku-puni o Maui, no ka mea, ua loa ia ia kaia aina no John Harbottle kona wakuakane i ka wa o kona maha ana i ka M. K. 1832, a ua loa hoi ia ia no ka Mui Hamehameha I, i ka wa kahiko.

Aua nohi oliuli oia a hiki i kona maha ana, hoi mai i kana mau hiki, a ke noho ole ole nei a hiki i kaia manawa.

Oia ka Makou e hooke nei no William Harbottle, ke kuleana hoi kona malali iho o ke ano Alodio, Ima e uku mai oia i ka ke Aupuni kapakapa; a hiki kupuni ia ia ka Palapala Sila Mui Oho Alodio. Ua hoo mai ke kuleana o na kanaka.

Ina ua ia ia ke uku mai no ka hookeoleole ana, a me ka hookeole ana i ka olele, Ima;

W. L. Lee

No ka aumi a me kupaia ana i ka olele mai ka Aupuni.

No ke kope ana i ka olele hoina.

No ka palapala hii

No ka hana ana i ka la

G. M. Robertson

No ke kope ana i na olele hooke

J. W. Smith

No ke ana ana i ka la 15, o Ianuari 1852.

No ke kope ana.

No ka hookeole ana i ka olele ma ka la 20, o Ianuari 1853

Ciama Palena.

Uku Pau loa

\$15.

Anaia e L. S. Wa.

Kuana ana i ke Ahipuana o Kaihia Komohana mai Kamakualoa, Moku-puni o Maui.

E hoomaha ana ma hookeoleole ma ke kaia o ka pali ma kahiko, ma ka Moku-puni o Kaihia Komohana, a me Kaihia Hikina, a e hoo ana.

Kema	13 1/2	Kom.	9.00	kaulaha	ma Kaihia Hikina.
Kema	18	Kom.	31.13	"	" " "
Kema	26 3/4	Kom.	12.45	"	" " "
Kema	35	Kom.	4.70	"	" " "
Kema	52 1/2	Kom.	15.24	"	" " "
Kema	13	Kom.	2.17	"	" " "
Kema	6 1/2	Kom.	10.27	"	" " "
Kema	26	Kom.	3.88	"	" " "
Kema	2 1/2	Kom.	17.90	"	" " " a hiki i ka Moku-puni

Kaihia Komohana, a me Kaihia Hikina, a me Puloa.

Kema	8	Hik.	9.09	kaulaha	e pili ana me Puloa.
Kema	51	Hik.	2.90	"	" " " "
Kema	23 1/2	Hik.	5.70	"	" " " "
Kema	5 1/2	Hik.	4.36	"	" " " "
Kema	18 1/4	Hik.	1.79	"	" " " "
Kema	20 1/4	Hik.	1.88	"	" " " "
Kema	13 3/4	Hik.	1.89	"	" " " "
Kema	32 1/2	Kom.	2.47	"	" " " "
Kema	36 1/2	Hik.	1.54	"	" " " "
Kema			81.00	"	" " " " a hiki i ka palena

o Kaihia Komohana.

Kema	83 1/4	Kom.	9.80	kaul.	palena mauka a hiki Kookala.
Akau			31.00	"	e pili ana ia Kookala.
Akau	15	Kom.	26.00	"	" " " " a hiki i ke mauka o Kookala.
Akau	13 1/4	Kom.	10.71	"	" " " " "
Akau	20 1/4	Hik.	29.89	"	" " " " "
Akau	31 1/2	Hik.	27.13	"	" " " " " a hiki i ka palena mauka o Moku-puni
Akau	38	Hik.	7.63	"	ma Moku-papakaua, a hiki i ka huan o Koolape, oia no ka palena mauka o Moku-papakaua.
Akau	50 1/2	Hikina	8.24	kaul.	e pili ana ia Moku-papakaua.
Akau	13 1/4	Hik.	10.52	"	" " " " "
Akau	48	Hik.	4.75	"	" " " " "
Akau	5 1/2	Hik.	11.37	"	" " " " "
Akau	50	Hik.	10.40	"	" " " " " a hiki i ka pali kahiko.

1474
NR. K.R.L.

Heima 60 Aite. 6.25 kaul. ma ka pali kahakoi a hiki i kaahi i hoomaka ai.
Oka ili o kua Ahupuaa o ka 172 Eka, 3 Ruda, a me na Roda 13.
L. S. Wa. Maa. and.
Lahainuluna 15 Jan. 1852.

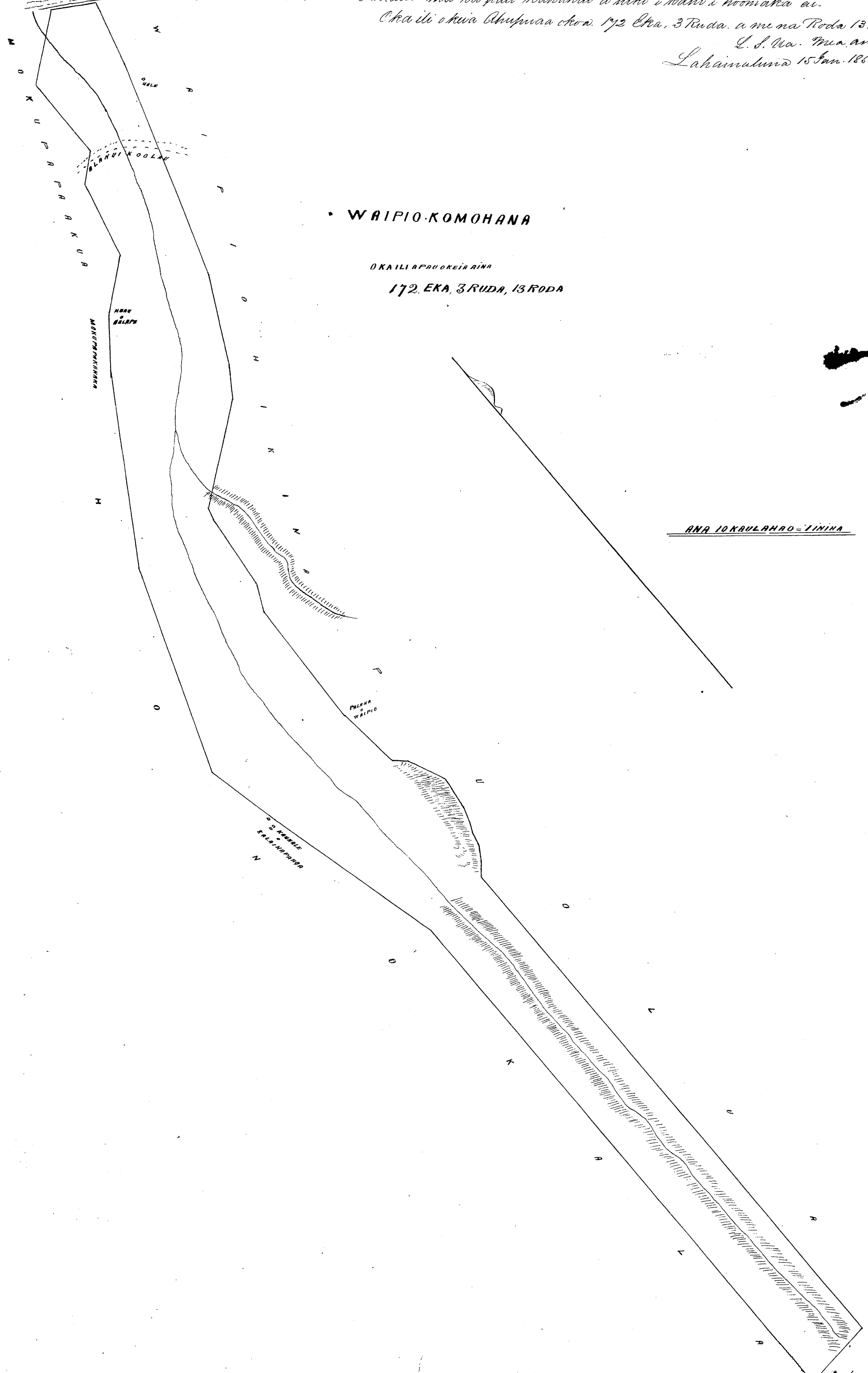

Helu 5047 Kalei (no Hauhiokalani)

Ua hoi mai oia no kona mau Apana Aina ma Iunui 2, Honolulu Aina, Motupuni Oahu. ma ka mea ua loa a keia mau wahi ia Kalei no Nahalelaulaha ke kono hiki mai i ka wa e oia ana. Iiiwa, a ua noho mau oia ma keia wahi a hiki i ka Matakahi 1850 hohi oia i keia wahi ia Nahalelaulaha ke kono hiki, ana Nahalelaulaha i kono hoia Hauhiokalani malaila, a wana i hana mau la hana o kono hiki, a ua noho oia i ka hiki i keia manawa.

Oia hoia makou e hoko nei no Hauhiokalani ke kule ana iwi kona malalo iho o ke ano Alodio. Iiiwa ikeu mai oia i ke ke Aupuni kapaia, alaila; ua kupaia ia ia ka Palapala Sila nui am Alodio.

Iono mai ia ia ke ikeu mai ma ka hoko kolo a me ka hoko oia i ka olelo, Ienei;

No ka auni a me ke paia ana i ka olelo ma ka Nupua.

No ke kope ana i ka olelo keia i ana

No ka palapala hii

No ka hana ana i ka la 3 Noemaba 1851.

No ke kope ana i na olelo keia 1 ana

No ke ana ana i ka la 7, o Noemaba 1851.

No ke kope ana

No ka hoko ana i ka olelo 21 Iamari 1853

Uku Paulson

\$6.00

W. L. Lee

G. M. Robinson

J. Kaulahao

J. H. Smith

Ienei na palena.

Apana 1. Aina Kalei.

Kelohakaka

Kuleana Kalei (no Hauhiokalani) Helu 5047, ma Iunui 2. Ii no Honolulu, Oahu.

Apana 1. Aina Kalei.

Ua holoia keia ma ka hoko oia i ka hiki i ke kono hiki mai i ka wa e oia ana. Iiiwa, a ua noho mau oia ma keia wahi a hiki i ka Matakahi 1850 hohi oia i keia wahi ia Nahalelaulaha ke kono hiki, ana Nahalelaulaha i kono hoia Hauhiokalani malaila, a wana i hana mau la hana o kono hiki, a ua noho oia i ka hiki i keia manawa.

E hoomaka ana ke kahi Kikina ma keia o keia aina, e pili ana me ke hoko oia i ka hiki i ke kono hiki mai i ka wa e oia ana. Iiiwa, a ua noho mau oia ma keia wahi a hiki i ka Matakahi 1850 hohi oia i keia wahi ia Nahalelaulaha ke kono hiki, ana Nahalelaulaha i kono hoia Hauhiokalani malaila, a wana i hana mau la hana o kono hiki, a ua noho oia i ka hiki i keia manawa.

Ma ka hoko oia i ka hiki i ke kono hiki mai i ka wa e oia ana. Iiiwa, a ua noho mau oia ma keia wahi a hiki i ka Matakahi 1850 hohi oia i keia wahi ia Nahalelaulaha ke kono hiki, ana Nahalelaulaha i kono hoia Hauhiokalani malaila, a wana i hana mau la hana o kono hiki, a ua noho oia i ka hiki i keia manawa.

Apana 2. Aina Kalei. E hoomaka ana ke kahi Kikina ma keia o keia aina, e pili ana me ke hoko oia i ka hiki i ke kono hiki mai i ka wa e oia ana. Iiiwa, a ua noho mau oia ma keia wahi a hiki i ka Matakahi 1850 hohi oia i keia wahi ia Nahalelaulaha ke kono hiki, ana Nahalelaulaha i kono hoia Hauhiokalani malaila, a wana i hana mau la hana o kono hiki, a ua noho oia i ka hiki i keia manawa.

of Honolulu 7 Noemaba 1851.

J. P. Kaulahao Iana

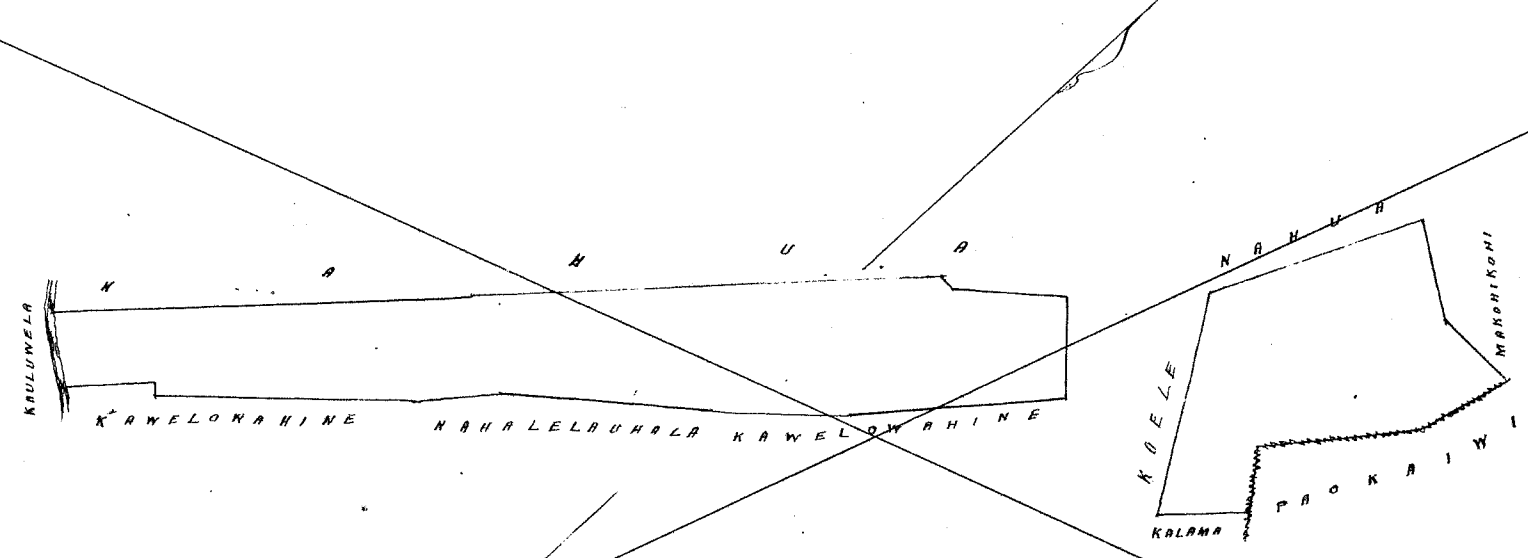

1/2 + 50 @ S. KAPUAI

100 KAPUAI INI

Hele 6714 Tuwone (no I. Kekaulahas.)

Ua koi mai oia no kona mau wahi ma Auwailimu ma Honolulu, Kona, ma ke Mokupuni o Oahu, no ka mea, ua loa ia ia keia mau wahi no Keawe Luahi mai i ka manawa e noho ana o I. Haalilio i Honolulu nei i ka makahiki 1841, a ua noko kea keu oleia a hiki i keia manawa, a i Nov. 4. 1851 ua hoolilo aku oia i keia mau wahi ia I. Kekaulahas a ka wa-pau ole. Oia ka makou e hooko nei no Tuwone a ia I. Kekaulahas, he kulevana hoi kona malalo iho o ke Aunui Alodio. Ina i uku mai oia i ke Aunui Kapahala, alaila, ua kupaona ia ka Palapala Lila Alodio.

Nono nua ia ia ke uku, no ka hookolokolo a me ka hooloho ana i ka olelo. Penei, -

- W. L. Lee No ka rumi a me ke fua ana i ka olelo ma ka Muepapa \$ Ten.
- G. M. Robertson No ke kope ana i ka olelo koina
- C. H. Smith No ka palapala kii
- No ka hana ana i ka la 25 Maraki 1851.
- No ke kope ana i na olelo a me ke kope i ka Aunui
- No ke ana ana i ka la 12 o Maraki 1851.
- No ke kope ana
- I. Kekaulahas No ka hooloho ana i ka olelo i ka la 7 o Februari 1853.

\$ 600

Oia ma palena. Anuia e I. W. Mahalena.

Apama 1. 1 Loi ma Auwailimu, Honolulu Aina, Oahu.

E hoomaka ana ma ke kahi Kema makai o keia e pili ana i ka Pa o E. C. Hall a me ke Alanui Anuanu, a holo N. 35° 30' K. i ka hui i ka loi poalima ma keia keia loi, a holo N. 44° Kom. 2 7/100 kaul. hiki i ka Auwai, alaila hui a holo Kom. 29° 30' Kom. 1 7/100 kaul. hiki i ka fua o E. C. Hall, a holo Kom. 45° 30' K. i 12 3/100 kaul. hiki i kahi i hoomaka i.

Okona ihi 245 Anana.

Apama 2. 2 Loi ma Auwailimu, Honolulu Aina, Oahu.

E hoomaka ana i ke ana ma ke kahi Somohana makai o keia ma kahi e pili ana i ka aina o Kahale a me Kaihe a holo ma ke Kahale aina, penei, N. 43° 30' K. i 2 7/100 kaul. - N. 36° Kom. 2 7/100 kaul. - N. 40° 30' K. i 2 7/100 kaul. - Kom. 39° 30' K. i 2 7/100 kaul. - N. 38° K. i 2 7/100 kaul. Hui a holo Kom. 52° K. i 2 kaul. hiki i ka aina o Kalunahinenui, K. i Kom. 39° Kom. 1 9/100 kaul. hiki i ka aina o Kaihe. Alaila hui N. 57° Kom. 2 7/100 kaul. hiki i kahi i hoomaka i.

Ma ia mau loi 387 2/10 Anana Tuu.

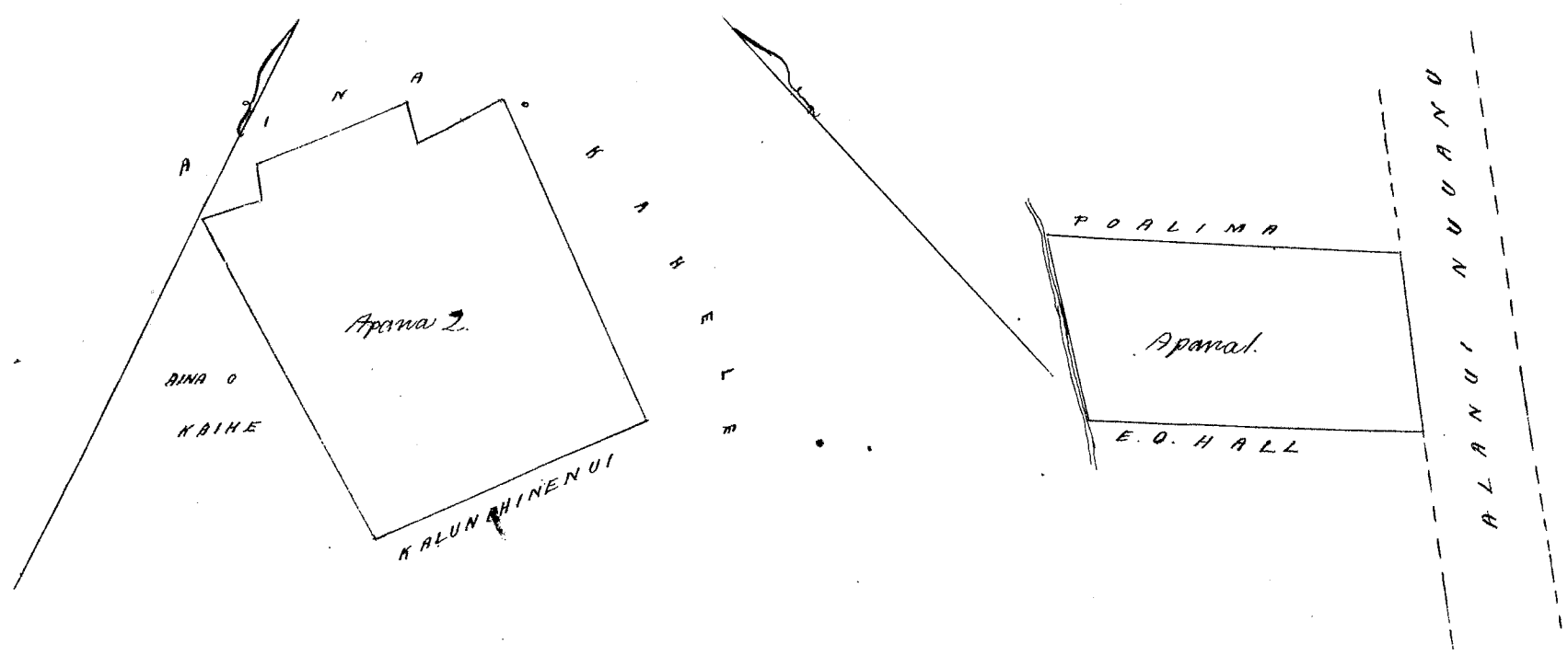

I KAULAHAO = INIHA.

Na kii mai oia no kona wahi ma Puka, Honolulu, Lona, ma ke Mokupuni Oahu, ma ke mea ua loaa ia ia kii wahi no Tokou mai i ka wa o ka holo ana I Kaalalo ma i Berr
 tamia i ka M. A. 1842, a ua noho he ake ole ia a hiki i keia manawa.

Ua ka mahou e hooke nei no Kawaiulu, he huleana hoi hooi maata i ka ke ano
 Alodi: Ina uku mai oia i ke ke Aupuni hooi hooi, alaila, hooi ia ia ka Palapala Sila Alodi
 Ima ma ia ia ke uku mo ka hooi hooi a me ka hooi hooi ana i ka ole Penci-

W. L. Lee
 G. M. Robertson
 J. H. Smith
 J. A. Kaulahao

No ka aumi a me ke pui ana i ka ole ma ka Puipea
 No ke kope ana i ka ole hooi -
 No ka palapala hii
 No ka hana ana i ka la 5, o ~~Oketopa~~ ~~1850~~
 No ke kope ana i na ole hooi 13^{ua}.
 No ke ana ana i ka la 23 Januara 1851.
 No ke kope ana.
 No ka hooi hooi ana i ka ole i ka la 10 Febuara 1853.

Cia ma palena,
 Ania e C. J. Lyons.

I. ke. E hoomaka ana ma ke kii Nika, a e hooi ana. Ak. 41 Kom. 1.06 kaul. & Ak. 31 1/2 Kom.
 2.50 kaul. ma ka aima o Honolulu, alaila Nema 49 1/2 Kom. 51 paku & Nema 18 Kom. 22 paku &
 Nema 62 1/2 Kom. ma ka aima o Lonaia, alaila Nema 41 1/4 Ak. 2.36 kaul. & Nema 45 Kom. 21
 paku & Nema 39 paku ma ka aima o Paka Honolulu, alaila Nema 53 1/2 Ak. 3 paku, ma
 ka aima o Pika, alaila Ak. 33 Nika 1.30 kaul. ma ka aima o Honolulu ma waenakonu o ka
 auwai a hiki ma kahi i hoomaka i. Maika o keia mau loi 53.3 rida.

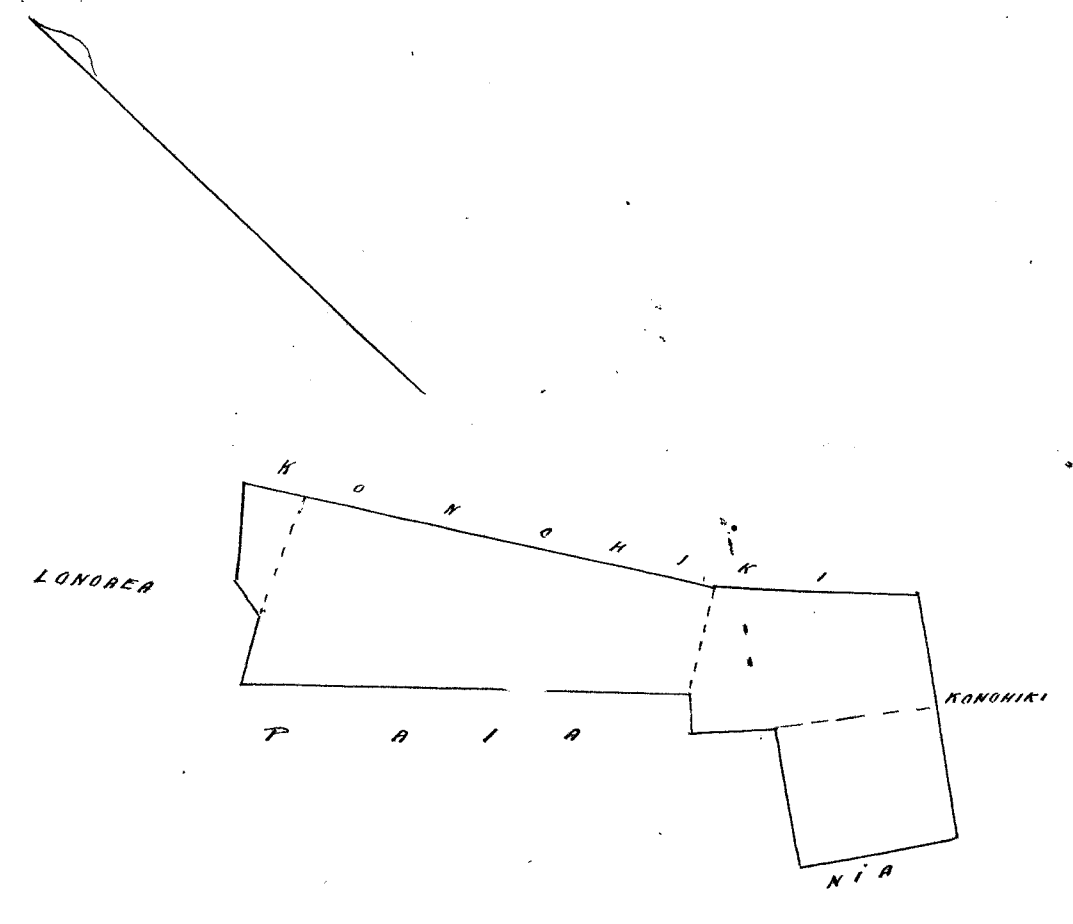

1 KAUL = 1 IINIH

Ua hoi mai oia no kene nau wahi ana Kaakofua i Honolulu ma Kona, ma ka Moku o Oahu; no ho mea, ur loaa ia ia keia mau wahi no Kawelo-kalani i ka makahiki 1847 a 8 paapa, a ua nolow keakea oleia a hiki i keia manawa.

Oia ka mauka i hooko nei no Keliiaa; he huleana hi i kona malalo iho, ke Ano Alodio. Ina e uku mai oia i ko ke Auferuni kapaha; a hila, ua kufino ia ia ka Palapala Ila Alodio.

Tono ma i ia ke uku no ka hookohokolo a me ka hookohouana i ka olelo, Peni;

Peni

- W. L. Lee No ka rumi a me ke pai ana i ka olelo ma ka Muepa.
- G. M. Robertson No ke kope ana i ka olelo Koina
- J. H. Smith No ka palapala kii
- J. Kakaulapa No ka hana ana i ka la 26 o Ianuari 1849
- No ke kope ana i na olelo a ma puke 13. Awa
- No ke ana ana i ka la 14 o Februari 1853
- No ke kope ana
- No ka hookohouana i ka olelo i ka la 28 o Februari 1853.

500

Oia na palapala Anai a S. Kalamo

Anai ma Honolulu Kaakofua, Honolulu, Oahu.

Apana 1. Pahale a me Loi. E hoomaka ma ke kahi Akau o keia ma ka kahi Hema o ke Ala Mahiai i fili ana me ka pa o Keanu, a holo Hema 53° Sik. 86 Pautu a fili ana me ka palapala o Keanu; Alaila Hema 44° Kom. 61 Pautu a me Hema 51° Sik. 95 Pautu me Kaawa, - Alaila Hema 39 1/2 Kom. 95 Pautu me Kamalie; Alaila Akau 43° Kom. 1 1/2 Kaulaha, a me Akau 45° Sik. 39 Pautu, a me Akau 57° Ko. 54 Pautu ma ke Akau a hiki i ka kahi Hema o ke Ala Ololi Mahiai. Alaila Akau 28° Sik. 1 7/8 Kaulaha; ma ia alanui a pumi i kahi i hoomaka i 194 1/2 Anana

Apana 2. Loi. E hoomaka ma ke kahi Komoana o keia Loi, a holo Akau 49° Sik. 88 Pautu me Keliheana, a Hema 43° Sik. 45 Pautu me Keanu, a Hema 57° Kom. 90 Pautu, a me Akau 40° Kom. 43 Pautu me Honolulu a pumi i kahi i hoomaka i 48 Anana Pautu 242 1/2 Anana.

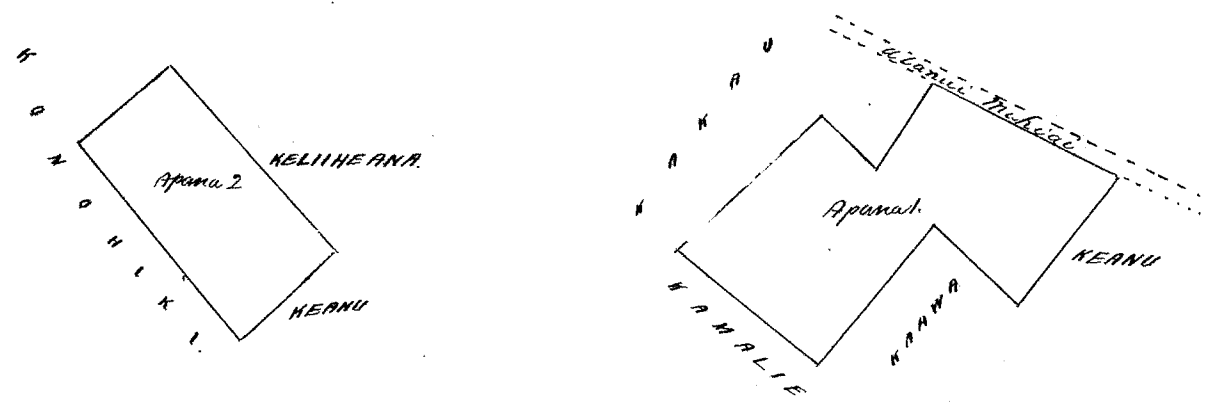

Kona 2.

Moai Aoao & 60 mai.

Ua koi mai oia no kona wahi ma Na Paa, ke Ahupuaa ma Kona, ma ka Mokuuini o Hawaii; no ka mea ua loaa ia ia keia wahi no ke Alii Kamehameha III mai i ka Mahela aia ana i ka makahiki 1848, a ua noho keakea oia a hiki i keia manawa.

Oia ka makou e hooko mai ma Iona Pitkoi; ke kuleana hii kua malalo iho o ke Am Alodii. Iona e ukui mai oia i ke ke Ahupuaa hapaha; alaila, ua kuuwano ia ia ka Palapala Pita Alodii. Koe mai ma kuleana i ma Hanaka maloko. Ua hooko aku makou i keia kuleana mamuli o ma olelo o ke Hanawai hou i hookoleia i ka la 19 o June M. A. 1852. e pili ana i ma Kowhiki.

Iona mai ia ia ke ukui no ka hookolokolo a me ka hookole ana i ka olelo. Penei

- W. L. Lee No ka rumi a me ke faia ana i ka olelo ma ka Muepa.
- G. M. Robertson No ke kope ana i ka olelo koina.
- W. Smith No ka palapala hii
- W. Smith No ka hana ana i ka la
- W. Smith No ke kope ana i ma olelo a ma hoike
- W. Smith No ke ana ana i ka la 23 o December 1852.
- W. Smith No ke kope ana
- W. Smith No ka hookole ana i ka olelo i ka la 1 o Mariki 1853.

\$ 20.00

Eia ma palena.

Anaia e W. S. Pease

Notes of Survey of the Ahupuaa of Land called Paa, situated in the District of Kona, Islands of Hawaii, made for and on behalf of J. Pitkoi.

Commencing upon the Sea, at the South easterly corner of this land, at a rock which stands opposite the South easterly corner of the pond called Kapuniaka, running from thence N. 65° W. 10 Chains along Southerly side of said pond, thence S 85° W. 15 Chains along Southerly side of said pond, thence N. 49° W. 98 Chains to a heap of stones, near the westerly side of the Mahaulepu Road, being bounded by the Ahupuaa of land called Mahaulepu, thence N. 32° E. 92 Chains to and along the Southerly side of the range of Hill, called Kookoni to a certain conical peak on said Range, thence N. 54° W. 25 Chains to a ball rock, called Koloakofoku, thence N. 10° W. 51 Chains, to the North easterly corner of this land, from thence following the top of the Mountain ridge westerly to the peak called Kookii, which from the North westerly corner of this land, from thence S. 11° W. 54 Chains, passing down the Southerly side of the Mt. range to the top of a low round hill called Ulupehupehu, which stands near the Northerly side of the Marsh called Palena; from thence S. 23° E. 231 Chains, passing said marsh and following the easterly boundary of the Ahupuaa of land called Meliweli to a heap of stones on the hill called Puhisimihuni from thence S. 24° E. 70 Chains following said boundary to a monument of stones standing upon the sea at the South westerly corner of this land, from thence following the sea to point of commencement comprising an Area of Three Thousand two hundred and sixty three Acres, one Rod and thirty three perches

(over side)

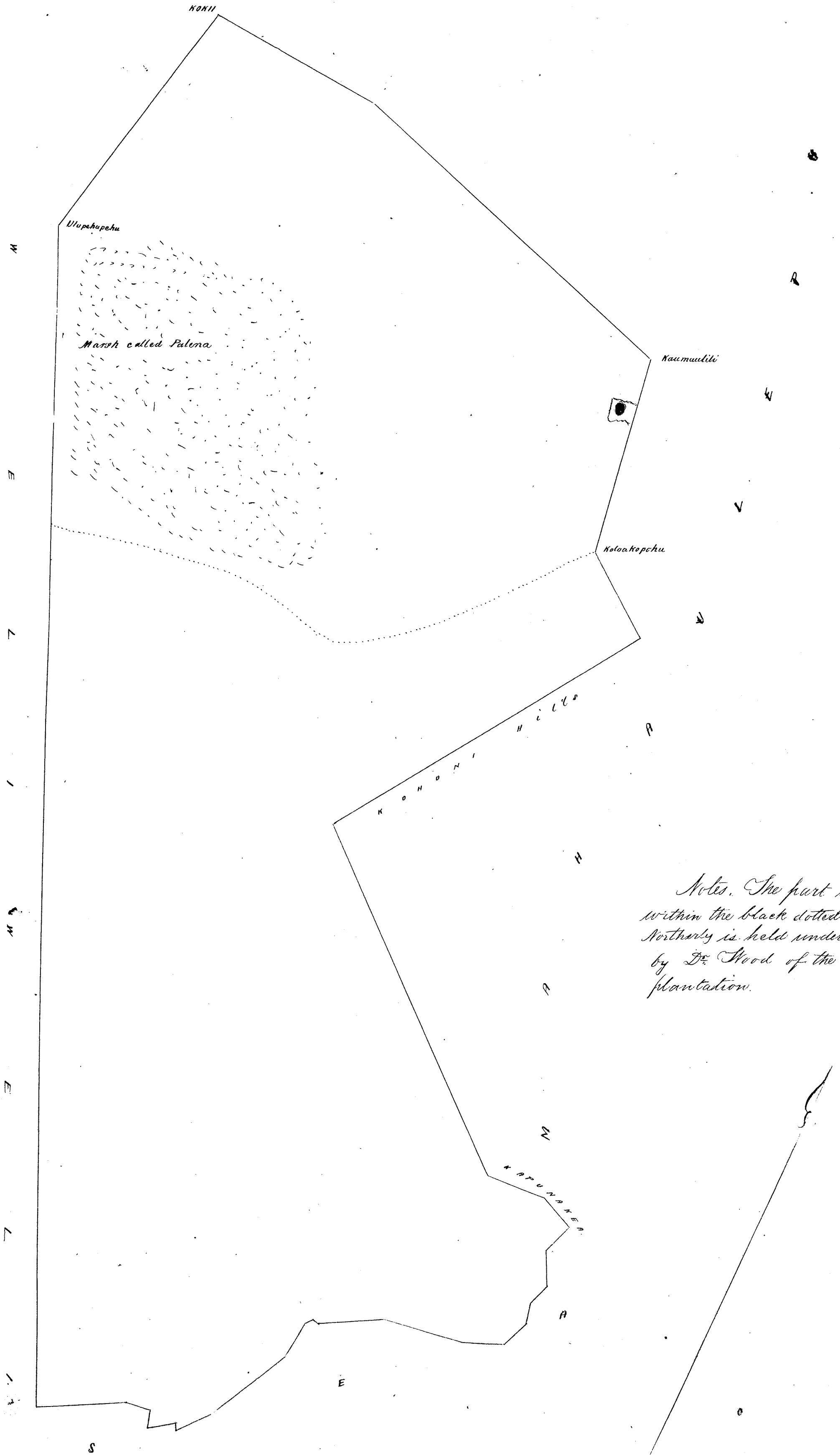

Notes. The part included within the black dotted lines northerly is held under lease by Dr. Hood of the Koloa plantation.

Hulu 5047 Kalia no Kauhialani.

ma Puumi, Ii no Kowuluu, Kona, Oahu.

(Mau aua 145 mau)
Title the same.

Apana 1. Aina kealo.

E hoomaka ma ke kahi Kikina mauka o keia aina e pili ana me ke kele
Aupuni, a me ke aia o Kawelohahine. A e holo Nema 38° Kom. 1 7/100 kaulahao, a me Nema
43° Kom. 1 1/100 kaul. e pili ana me ke aia o Kawelohahine, alaila Nema 46° 30' Kom. 1 7/100 kaulahao
ma ke Kahalelahuala a hiki i ke Aupuni, alaila Akau 54° Kom. 82 Pauh. e pili ana me ke Aupuni a
hiki i ke aia o Dr. Rooke, alaila Akau 39° 30' Niki. 3 6/100 kaulahao, a me Nema 89° Niki. 14 Pauh. a
me Akau 37° Niki. 42 Pauh. a me Akau 50° Niki. 50 Pauh. e pili ana me ke aia o Dr. Rooke ia
Kahua, a hiki i ke kahi Komohana mauka o keia. alaila Nema 47° Niki. 80 Pauh. ma ke Dr. Rooke
a me ke kele Aupuni a hiki i ke hoomaka ana. 532 Apana.

Apana 2. Aina hula.

E hoomaka ma ke pohaku i hoailowai x me ke huleana o Matohitohi ia W. L. Lee
ke kahi Komohana Akau o keia Aina. A e holo Nema 27° 30' Kom. 135 kapuwi, a hiki i ke kahi Komohana
- ma o keia Apana aia, a me Nema 42° 45' Niki. 118 kapuwi e pili ana ia mau aua me ke aia o
Dr. Rooke, a me ke kele Aupuni, a hiki i ke hula i oleloia me ke huleana o Kalama, alaila Akau 39°
30' Niki. 47 kapuwi ma ia hula a hiki i ke papohaku o Kairi, alaila Akau 39° 30' Kom. 32 kapuwi, a
me Akau 35° Niki. 37 kapuwi, a me Akau 11° Niki. 51 kapuwi, ma ke pa o Kairi a hiki i ke Matohi-
- kahi ia W. L. Lee, alaila Nema 86° 30' Kom. 46 kapuwi, hiki i ke pohaku, a me Akau 59° 30' Kom.
52 kapuwi me ke W. L. Lee a hiki i ke hoomaka ana. 426 Apana 15 Kapuwi.

958 15/36 Apana - Pauloa.

S. J. Kalama.
I ana -

Marahi 3. 1853.

G. M. Robertson
D. H. Smith
I. Kekaulaha

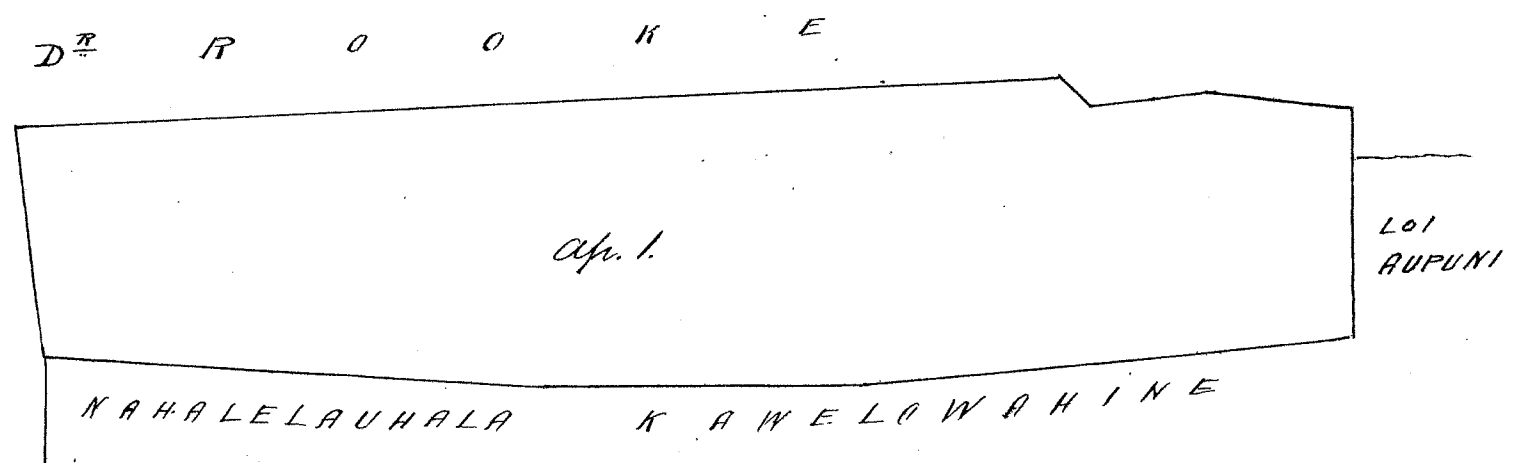
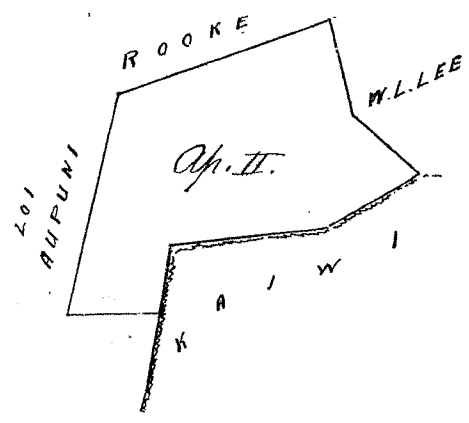

1/2 x 3. Scale
66 Kapuwi

Hulu 6252 Kekukahiko.

Ua koi mai oia me kona mau wahi ma Kawabawai i Kaikiki ma Kona, ma ke Motu
puni Oahu; me ke mea, ua loa ia ia keia wahi no ke Mii Kamewamewa III mai i ke Mahele
aina ana i ke makahiki 1848, a ua noho keakea oleia a hiki i keia manawa.

Oia kei mauka e hooke me no Kekukahiko; ke huleana hoi kona mahele iho o ke Aina
Alodio. Ima e ulu mai oia i ke ke Aupuni kapuwi; alaila, ua kupaia ia ia ke Palapala
Pila Alodio. Ika, hoi mai ma huleana o ma hana mahele. Ua hooke aku mauka i keia
huleana mamuli, o na olelo o ke Kawabawai hoi i hooholoia i ke la 19 o Iuni Mo. H. 1852, e
pili ana i na Kowohiki.

Pono nae iaia ke ukui no ka hooholokolo a me ka hooholo ana i ka olelo. Ima,

No ka oumu a muke, pua ana i ka olelo ana ka *Maupua*
 No ke kope ana i ka olelo *koima*
 No ke palapala kii
 No ka hana ana i ka la 3. o Februari 1848.
 No ke kope ana i na olelo ana koike
 No ke ana ana i ka la
 No ke kope ana
 No ka hooholo ana i ka olelo i ka la 9. o Maraki 1853.

\$ 15 00

Eia na palena. Anaia i A. Bishop.

He aina i ka Iiaina o Kaalawai, Waikiki, Oahu.

Ipana 1. He mo'oihoko o Kaalawai, Waikiki. E hoomaka ma ke kiki *Maupua* ana
 i hele ana *Hema* 54. Hiki i 4, 15 kth. ma ka palena o *Keokapu*. Mabatua aku *Mk. 39* Hiki i
 1, 70 kth. ma ka palena o *Mahelele*. Mabatua aku *Mk. 50* Kom. i 4, 65 kth. ma ka palena
 no *Kaahawai*. Mabatua aku *Hem. 27* Kom. i 2, 20 kth. ma ka hana ana a hiki i ka hoomaka ana.
 He 8 ⁵/₁₀₀ kth. huinaha.

Ipana 2. He kula i Kaalawai. E hoomaka ma ke kiki *Maupua* ana i hele ana *Hema* 47 ¹/₂
 Hiki i 4, 10 kth. ma ka palena no *Kaahawai*. Mabatua aku *Hema* 47 Kom. i 2, 98 kth. ma
 ka palena no *Keokapu*. Mabatua aku *Mk. 43 1/2* Kom. i 3, 90 kth. ma ka palena no *Mahelele*.
 Mabatua aku *Mk. 44* Hiki i 2, 80 kth. ma ka hana ana o *Pahua* a hiki i ka hoomaka ana.
 He 6 ²/₁₀₀ kth. huinaha.

Ipana 3. He mo'oihoko o Kaalawai. E hoomaka ma ke kiki *Maupua* ana i hele ana
Hema 40 Hiki i 1, 74 kth. ma ka palena o *Pahupahuapuaa*. Mabatua aku *Hem. 45* Kom.
 i 16, 40 kth. ma ka palena no *Mahelele*. Mabatua aku *Mk. 46* Kom. i 1, 00 kth. ma ka hana ana.
 Mabatua aku *Mk. 44* Hiki i 1, 60 kth. ma ka palena no *Mahelele* a hiki i ka hoomaka
 ana. He 2 Eka 3 kth. huinaha.

Ipana 4. He mo'oihoko o Kaalawai. E hoomaka ma ke kiki *Maupua* ana i hele ana
Hema 47 Hiki i 1, 20 kth. ma ka palena o *Keokapu*. Mabatua aku *Hem. 45* Kom. i 2, 90 kth.
 ma ka palena o *Keokapu*. Mabatua aku *Mk. 44 1/2* Kom. i 1, 10 kth. ma ka palena no *Kaahawai*.
 Mabatua aku *Hem. 45* Kom. i 1, 35 kth. Mabatua aku *Hem. 46* Hiki i 1, 00 kth. ma ka palena
 no *Kaahawai*. Mabatua aku *Hem. 50 1/2* Kom. i 7, 23 kth. ma ka palena no *Mahelele*. Mabatua
 aku *Mk. 45* Kom. i 0, 83 kth. ma ka hana ana. Mabatua aku *Mk. 45* Hiki i 11, 40 kth. a hiki i
 ka hoomaka ana. He 1 Eka. = *Pahua* He 7 ⁸/₁₀₀ kth. huinaha.

8.56
 1.6.27
 2.37
 25.7.83

A. Bishop
 Mea Ana
 Given up
 507.8312
 1 6.27
 He 1.56

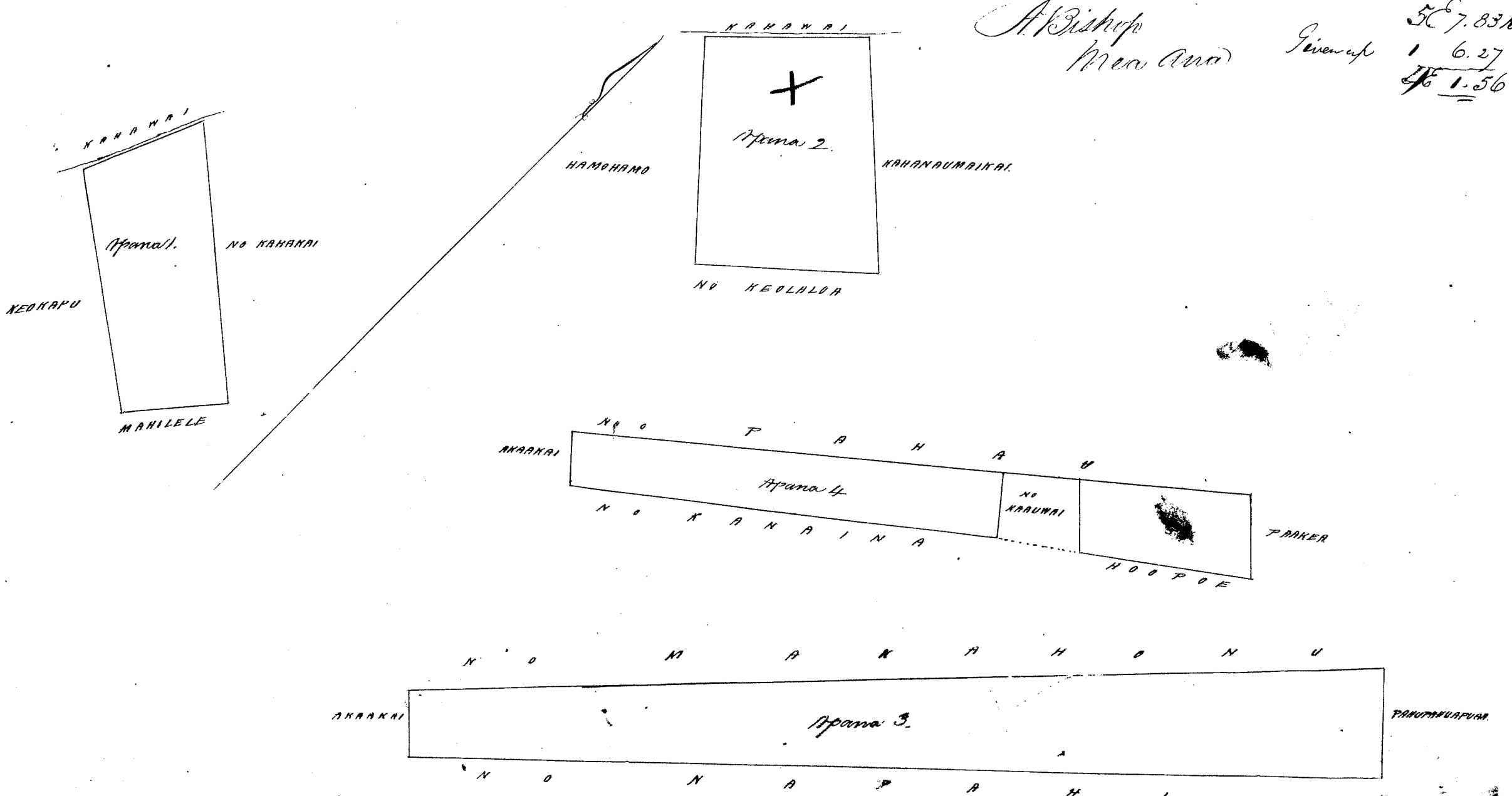

Part 1st

Ua kōi mai oia no kona wahi ma Kapahu ma Hilo ma ka Mokupuni o Hawaii, no ka mea, ua loaia keia wahi no ke Alii Kamehameha III mai i ka Mahalo aia ana i ka makahiki 1848, a ua noho keakea oia a hiki i keia manawa.

Oia ka makou e hōko nei no Kaupohia, he kuleana hoi kona mabalo iho o ke Amo Aloha. Ina e ukū mai oia i ke Alii Kapahu, alaila, ua kōpuna ia ia ka Palapala o ke Amo Aloha. Aka, koe mau ma kuleana o na Kanaka mākae.

Tono mai ia ia ke ukū no ka hōkolohele a me ka hōhola ana i ka olelo. Penei—

- W. L. Lee No ka nūmi a me ke kupaia ana i ka olelo ma ka Mūpepa. \$ Ken.
- No ke kōpe ana i ka olelo kōma
- No ka palapala kōi.
- G. M. Robertson No ka hana ana i ka ka
- J. H. Smith No ke kōpe ana i ka olelo a ma hōi ke
- No ka ana ana i ka ka
- J. K. Kaulaha No ke kōpe ana
- No ka hōhola ana i ka olelo i ka ka 12 o Māwaka 1853.

\$ 10.00

Oia na palapala. O Anaia e Ke. No Lyman

Ahupuaa o Kapahu, Hilo, Hawaii.

O hōmaka keia makūhiki Maui o ke kaupohia kula o Kene, a e holo i ka ma ka iwi o keia aiaa Hema 60° Kom. 5, 00 kaul. Hema. 56° Kom. 11, 14 kaul. - Hema. 61½ Kom. 3, 80 kaul. - Hema. 31½ Kom. 2, 26 kaul. - Hema. 11½ Kom. 3, 88 kaul. - Hema 22½ Kom. 6, 33 kaul. Hema. 43½ Kom. 3, 70 kaul. - Hema. 60° Kom. 3, 86 kaul. Hema. 50° Kom. 6, 50 kaul. Hema. 35¼ Kom. 17, 20 kaul. Hema 72¾ Kom. 15, 88 kaul. i ka hiki kōma kukui na hōhōlanaia K, oia ke kōi ma ka ma keia aiaa; Alaila e holo Ma. 59° Kom. 11, 20 kaul. i ka hiki kukui na hōhōlanaia K.K. Alaila Ma. 81¼ Kom. 6, 60 kaul. Ma. 47½ Kom. 15, 38 kaul. i ka hiki hōhōlanaia ma ka hōhōlanaia o Kaupohia; Alaila e holo ma ia ka hōhōlanaia aiaa, - Ma. 65¼ Hiki. 22, 84 kaul. Ma. 66° Hiki. 29, 00 kaul. Ma. 48½ Hiki. 5, 00 kaul. - Ma. 81° Hiki. 2, 52 kaul. Ma. 52½ Hiki. 1, 86 kaul. Ma. 19° Hiki. 2, 88 kaul. Ma. 5¼ Hiki. 4, 00 kaul. Hema. 86° Hiki. 4, 64 kaul. - Ma. 18° Hiki. 2, 24 kaul. Ma. 51° Hiki. 4, 00 kaul. - Ma. 38½ Hiki. 3, 40 kaul. - Ma. 71¼ Hiki. 6, 44 kaul. Ma. 31¾ Hiki. 4, 48 kaul. Ma. 50½ Hiki. 21, 00 kaul. Ma. 13° Hiki. 2, 40 kaul. Ma. 47¾ Hiki. 6, 96 kaul. - Hema. 86° Hiki. 4, 60 kaul. Ma. 71½ Hiki. 6, 02 kaul. Hema. 77° Hiki. 6, 96 kaul. Ma. 17° Hiki. 3, 20 kaul. Ma. 1½ Hiki. 4, 86 kaul. Ma. 5½ Kom. 3, 44 kaul. Ma. 17° Hiki. 5, 00 kaul. Ma. 39½ Hiki. 4, 60 kaul. Ma. 2° Kom. 2, 60 kaul. i ka hōhōlanaia, Alaila e holo ma ka hōhōlanaia. - Hema. 88° Hiki. 7, 34 kaul. i ka hōhōlanaia hōhōlanaia; Alaila e holo i ka ma ka iwi o keia aiaa o Kene, Hema. 43° Kom. 7, 20 kaul. Hema. 30¾ Kom. 15, 28 kaul. Hema. 50° Kom. 1, 80 kaul. Hema. 27½ Kom. 5, 38 kaul. Hema. 34½ Kom. 4, 50 kaul. Hema. 45° Kom. 5, 15 kaul. Hema. 57½ Kom. 10, 58 kaul. Hema. 43½ Kom. 12, 20 kaul. Hema. 38½ Kom. 7, 40 kaul. Hema. 52° Kom. 6, 92 kaul. a hiki ma ka hōhōlanaia e hōmaka i.

Makou o keia aiaa 241 6/10 Eka.

(Nawa ma o i ke kōi.)

Ahupuaa o "Koaheku"
Hilo, ^{ma} Hawaii
Kauihola



Ua koi mai oia nei kono mau wahi ma Hamakua i Honolulu ma Kona ma ka Mokupuni o Oahu; no ka mea, ua loa ia ia keia mau wahi no Ehu a me Kaha mai i ka hui paku ana mai o T. Kaalilio i ka makahiki 1845, a ua mohu keakea oleia a hiki i keia manawa.

Oia ka maku e hooke ni mo Kukeleaumoku, ke kuleana hoi kono matato iho o ke Aho Alodi, Ina e ukui mai oia i ke ke Aupuni hapaha, alaila, ua kupa no iaia ka Palapala Eila Alodi. Iona no maewa ia ke ukui no ka hoo holo kolo a me ka hoo holo awai i ka olelo. Ima,

G. M. Robertson
J. H. Smith
W. L. Lee
J. Kekaulaha

No ka aumi a me ke paia i ka olelo ma ka Muepa
No ke kope ana i ka olelo koma
No ka palapala hii
No ka hana ana i ka la 12 o Novemaba 1851.
No ka kope ana i na olelo a ma hoi ke 1/2 Awa
No ke ana ana i ka la 26 Maraki 1853. - Ukuia ke ana \$5,-
No ke kope ana
No ka hoo holo ana i ka olelo i ka la 6 o Aperila 1853.

\$ 3 00

Eia na palapala. Anaia e S. P. Kalama

(Aina ma Hamakua, Honolulu, Oahu.
Apana 1. Loi. E hoomaka ma ke kiki Kema, a i holo Akau 40° Kom. 130 Paku, ma ka Loi o Kahuahine i ka hiki i ka auwai, - Alaila Akau 32° Hikina 72 Paku ma ka auwai me Kahuahine i ka hiki i ka auwai, - Alaila Kema 42° 30' Hikina 117 Paku a me Kema 23° Hikina 41 Paku, a me Kema 54° 30' Kom. 62 Paku. - Ma ia Apana 124 Anana

Apana 2. Makale Loi. E hoomaka ma ke kiki Kema o ka Pahale o Kona ma ka kiki ma ka Ala Olo Kahuahine, a i holo ma ka ana o Kona Akau 26° Hikina 100 Paku ma ka pa, a me Kema 52° Hik. 206 Paku, a me Kema 30° Hikina 84 Paku pili ana me Kona, - Alaila Kema 53° 30' Kom. 73 Paku, a me Akau 78° Kom. 23 Paku me kula Konoheki a hiki i ke kiki Hikina o ka Makale Loi o Puaiki. Alaila Kema 89° 15' Kom. ma ka Loi e hoo kaawale ana i ke Puaiki Makale a hiki i ka paku ma ka ana o Konoheki me Palila, - Alaila Akau 12° Kom. 31 Paku, a me Akau 38° Kom. 25 Paku me ke Palila a hiki i ka pa, - Alaila 107 Paku ma ka pa me ke Ala Olo a hiki i ka hoomaka ana. Maloko oia Apana 422 1/2 Anana. Pau loa 546 1/2 Anana

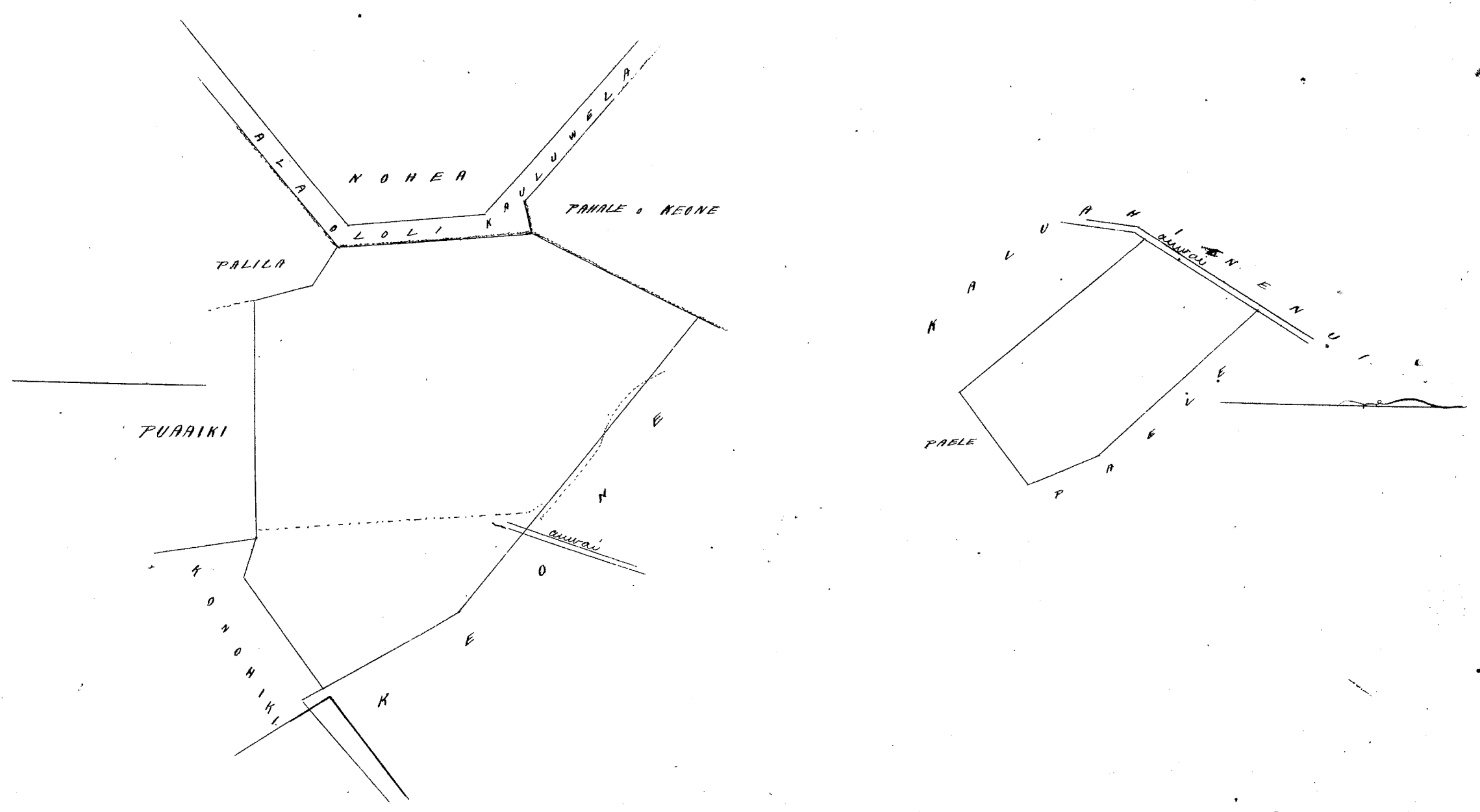

Hei 7239 Punini

Ua koi mai oia no kona wahi ma Heiwa i Honolulu, ma Kona, ma ka (Mokupuni) Oahu; no ka mea, ua hoia i ia i keia mau wahi no Kahakiki mai i ka makahiki 1839, aua no ka heateka oia a hiki i keia manawa.

Oia ka maku e hoko mai no Punini; he kuleana hoki kona ma lalo iho o ka Awa Urdio; aua e uku mai ia i keia mau wahi o Aupuni hapaha; aiaia, ua kupo ia ia ka Palapala Ika Urdio.

Tou maeia ia ke uku no ka hokohoko a me ka hoholo ana i ka olelo. - Penei, -

W. L. Lee
 G. M. Robertson
 J. H. Smith
 J. Hekeaulaao

No ka oia i me ke paia ana i ka olelo ma ka Muepa
 No ka kope ana i ka olelo koia
 No ka palapala kii
 No ka hana ana i ka la 1 o Novemaba 1851.
 No ka kope ana i ka olelo a ma hiki 1/3 Aaa
 No ka ana ana i ka la 6 o Novemaba 1853. Ukuia ke ana 1/5.
 No ka kope ana
 No ka hoholo ana i ka olelo i ka la 6 o Aperila 1853.

§ Kon

Oia ma palena. Aiaia e S. Palena

4 00

Aia ma Heiwa, Honolulu, Kona, Oahu.
 Poi me Heiwa. E hoko ana ma ka pohaku hoailona pea x o Amihia ma ka
 papohaku malena, ke hiki i Komohama Maui ma ka o keia aina, a v holo (Heima 48; Hikiina
 5) Kaulaao a hiki i ka pa aina malalo, a Maui 63° 30' (Hikiina 34) Paiku ma ka pa aina a hiki
 pohaku malena iho o ka hiki auwai, a Heima 19° 30' (Hikiina 58) Paiku ma ka auwai hiki i
 kuauna, a Heima 54; Hikiina 275 Paiku, a me Heima 59; Hikiina 226 Paiku ma ka ma ka
 palena o Amihia a me ke Aupuni a hiki i ke hiki (Hikiina Heima o keia aina. Aiaia Maui
 33° 30' (Hikiina 73) Paiku (hiki Hikiina Maui o keia) a me Maui 49° Kom. 4 (Kaulaao, a Maui
 45° 30' (Hikiina 35) Paiku a Maui 36° Kom. 6 (Kaulaao ma ka palena o ka aina Aupuni a
 hiki i ka hoailona) pea x ma ka pohaku nui. - Aiaia Heima 67° 30' (Kom. 31) Paiku ma ka pa-
 pohaku a hiki i ka hoailona ana. Maui Aina 1 5/8 Eka.

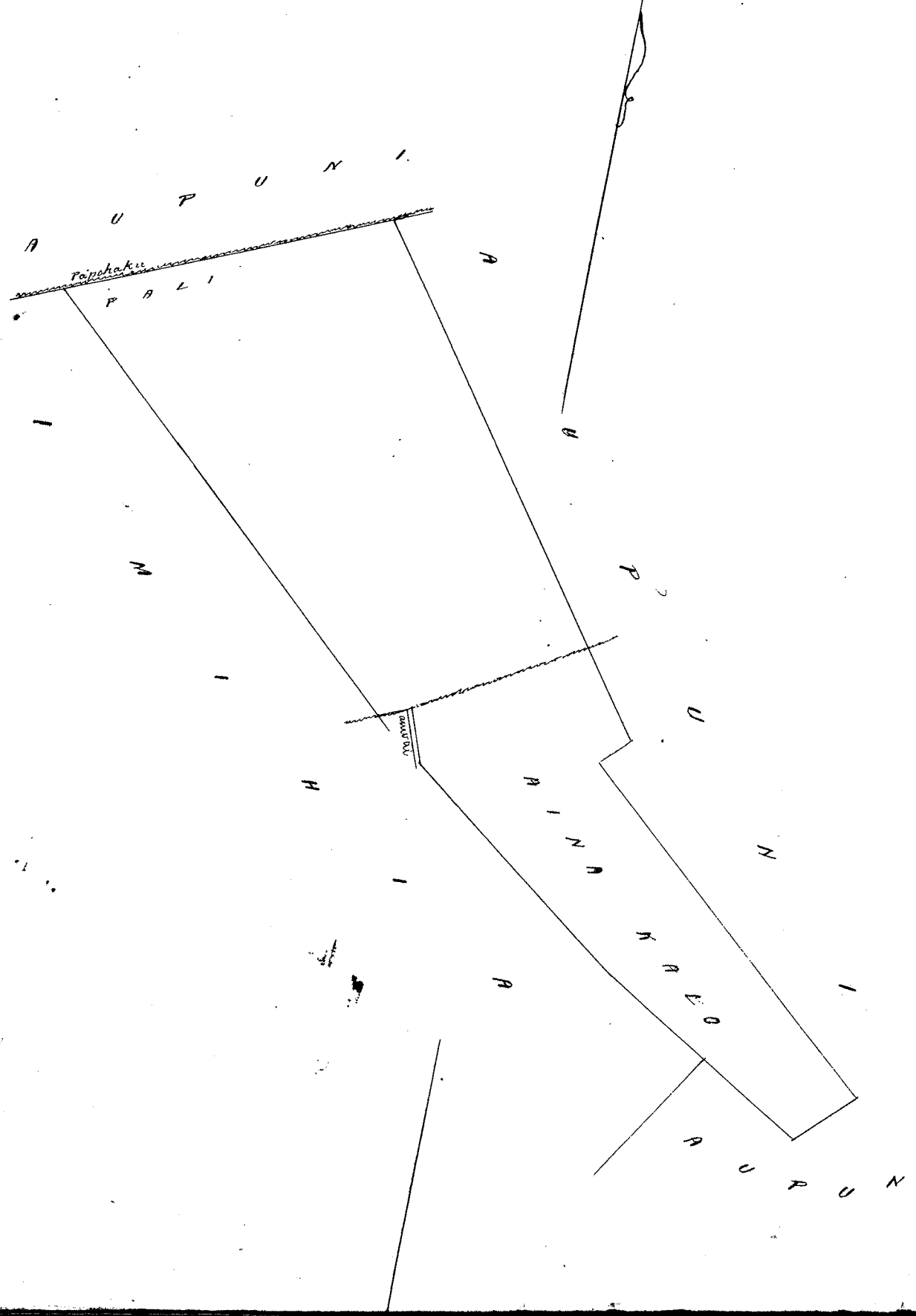

SCALE
 3/4 Incha = Kaulaao

Heleu 7156 Kapali (no Muiumui.)

Ua hoi mai oia no Hona wahi ma Heleu, Honolulu, ma Hona, ma ka Moku o Kapali, ma ka mea, ua loa ia ia keia wahi no Kahakahi mai i ka makahiki 1839, a ua noho keakea oleia he hiki i kona wahi ma ke ai i ka malamua o Dekemaba 25, 1848, kooili i keia aia i ka wahi i Muiumui a me kana mau hiki, a ua noho keakea oleia haku a hiki i keia manawa.

Oia ka mauka e hooke me no Kapali a i kona mau huihina; he kuleana hoi ke haku malalo iho o ke Ano Alodi. Ina e uku mai oia i ke ke Aupuni kapaha; - Alaila, ua kupo no ia ia ka Palapala Ika Alodi.

Pono mai ia ia ke uku no ka hookelele a me ka hoohele ana i ka olelo; Penei; -

W. L. Lee
G. M. Robertson
M. Smith
J. Kekaulahas

No ka rumi a me ke paia ana i ka olelo ma ka Muepa.
No ke kope ana i ka olelo koina
No ka palapala kii
No ka hana ana i ka lei 1 o Novemaba 1851.
No ke kope ana i na olelo a ma hoi ke 3 Iwa
No ke ana ana i ka lei 6 o Novemaba 1852. Ukuia ke ana \$5.00
No ke kope ana
No ka hoohele ana i ka olelo i ka lei 6 o Aperila 1853.

\$ Ken.

Eia na palena.

Aiaia e A. P. Kalamo

\$ 5.55

Aia ma Heleu, Honolulu, Hona, Oahu.

Lei kato a me kula o Kele. E hoomaka ma ka pohaku hoailonaia 11 ma ka papohaku o ka aia maluna o ka pali. A e holo Heleu 57° 30' Hikina 169 Paku, a Heleu 41' Hikina 39' Paku, a Hona 85' Hikina 74 Paku a hiki i ka pohaku oia maluna a o ka wahi o ke ana kupaapa, a Hona 22' Hikina 189 Paku iho a hiki i ka puka, a Hona 56° 30' Hikina 245 Paku e pili ana ia mau aia me ka aia o ke Aupuni a hiki i ke kumu o ke Alani S. P. Judd e pili ana me ka aia o Hona, Alaila Hona 35' Hona 94 Paku, a me Hona 55' Hikina 108 Paku a me Hona 28' Hikina 171 Paku a me Hona 35° 30' Hikina 328 Paku e pili ana me ka aia o Hona, a hiki i ka palena o Olu ma ka ana o Namai. Alaila Hona 44° 45' Hona 102 Paku ma ka Namai a hiki i ke hiki (Hikina Hona o keia aia. Alaila Heleu 44' Hona holo holo e pili ana me ka aia o Kahumapo no Namai a hiki i ka hiki i hoomaka i.

Maia Aia 2 1/10 Eka

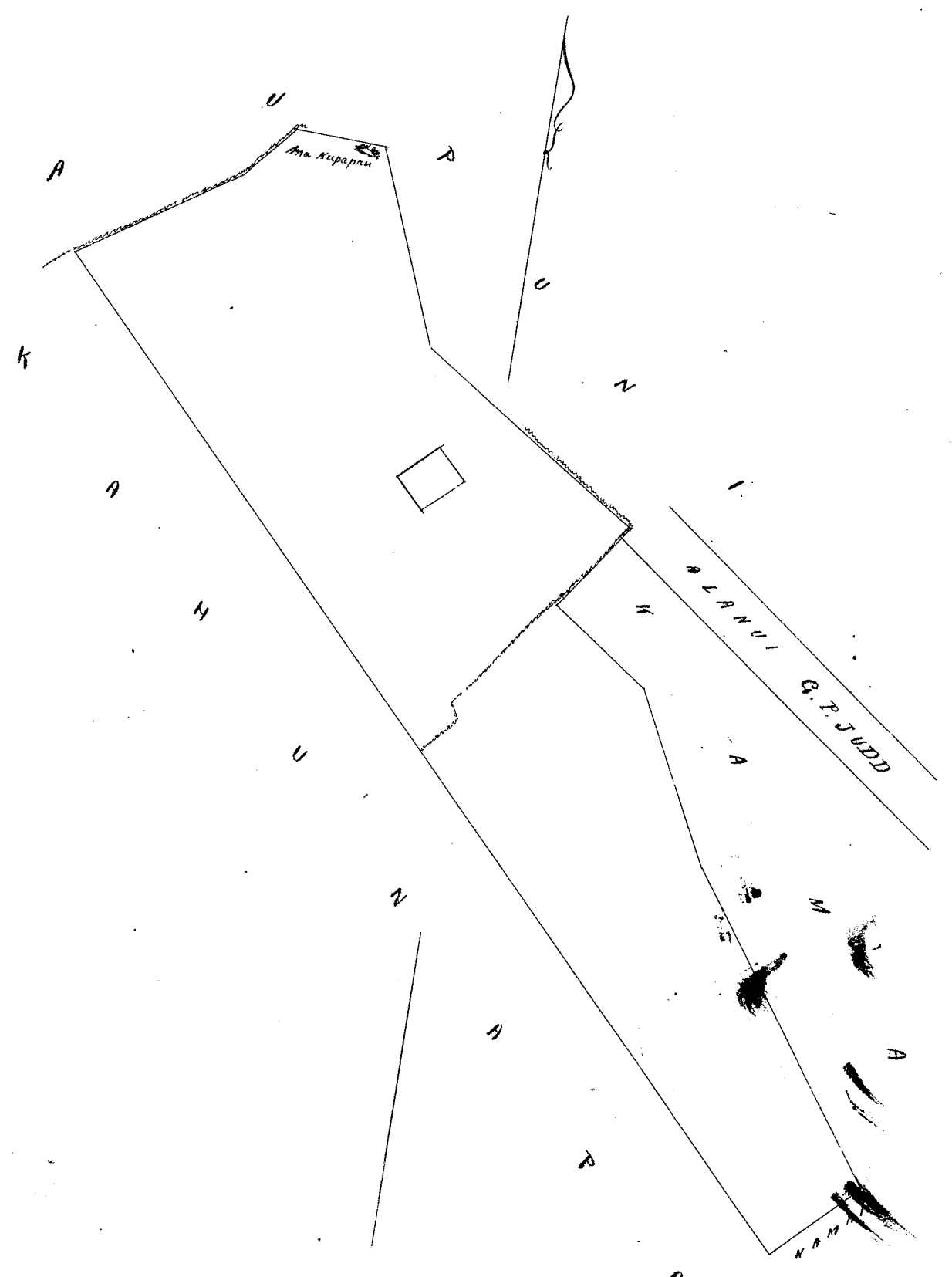

Kele 8001 I. Kaapuiki

Ua kōi mai oia no kona wahi Pahale ma Honolulu ma Kona, ma ka Mokupuni Oahu; no ka mea ua lōa ia ia keia wahi no Hanaki mai ma ka palapala keuoha a Hanaki no I. Kaapuiki i keia makahiki 1846. He wahi nae keia i hoopaapaia no ke kōi ana mai a Kaau moana ke kauhane o Hanaki; no ka mea, ua nōho pu no o Hanaki a me Kaau moana ma keia wahi a I. Kaapuiki i kōi mai nei, a ua like hoika manawa o ka lōa ana ia lōa maika makahiki 1837, a ua kuku like no i ma hale a hāna no kōi i keia pu a ua nōho no malaila a hiki i keia make ana. A no ka mui o ka hoopaapaia a me ke aumeume ana iwaena o lōa, a no ka holo ole iwaena o na aoao eua, nōhoia wa hoounaia kekahi mau lūna o makou e makele e like me keia kōi i hoikeia onalalo, a ua ae like ma aoao eua ma ia (Makele ana, aole ke aumeume hou a hiki i keia la.

Oia ka makou e hooko-mui no I. Kaapuiki; he kōle ana kōi kona malalo iho o ke Awo Alodio. Ima e ukū mai oia i ke ke Aupuni hōpaha; alaila, ua kōpono ia ia ka Palapala Sela Alodio.

Pono mai ia ia ke ukū no ka hooholo a me ka hooholo ana i keia olelo. Puni,

- | | | |
|-----------------|--|--------|
| | No ka rami a me ke paia ana i keia olelo ma ka Nupepa | \$ 100 |
| G. M. Robertson | No ke kōpe ana i keia olelo kōina | |
| | No ka palapala kōi | |
| J. H. Smith | No ke hōma ana i keia la 25 o Maraki 1850. | |
| W. L. Lee | No ke kōpe ana i ma olelo a na hoike 2 Aoao | |
| J. H. Kaulahao | No ke ana ana i keia la 29 o Maraki 1853. | |
| | No ke kōpe ana | |
| | No ka hooholo ana i keia olelo i keia la 6 o Aperila 1853. | |

Eia na palena. \$ 500

Anaia e I. Kaapuiki

Pahale ma Honolulu Kona, Oahu.

Hoohōmau ma ke hiki Kōma o keia pu, a e holo Akau 45°
 Komohana 79 Pūku ma Kaau moana a hiki i ke Alama, - Alaila Akau 52° Hōkina 80
 Pūku ma ke Alama Smith, - Alaila Kōma 37° Hōkina 37 Pūku ma kahi waiho wale
 wale o ke Alama a hiki i ke Auakolu, - Alaila Kōma 34° Komohana 53 Pūku a me Kōma
 24° Hōkina 19 Pūku a me Kōma 24° Komohana 16 Pūku ma ke Auakolu a hiki i ke
 Hoohōmau ana

Ma keia Pahale 48 Anana.

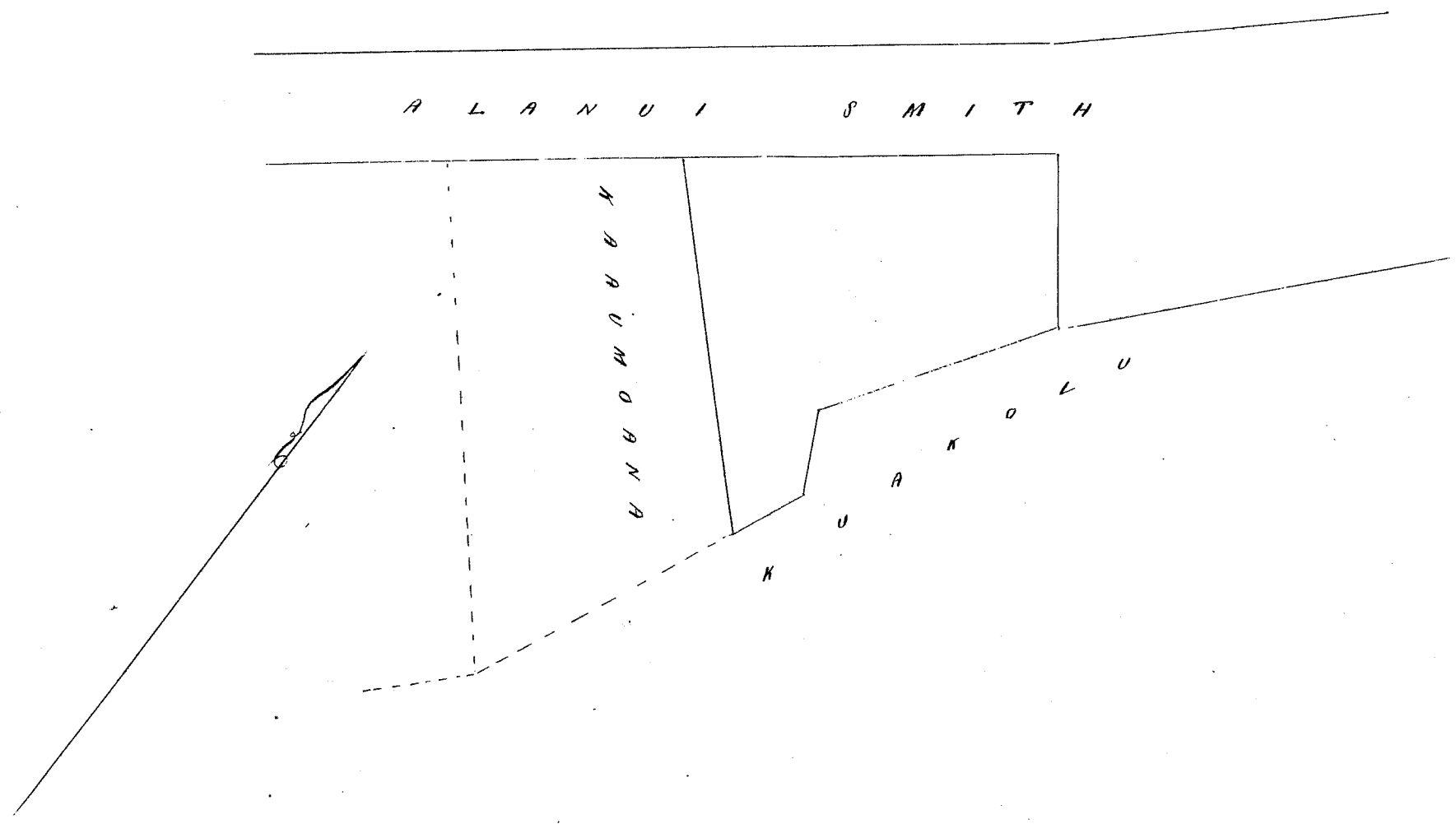

66 FEET = 3 IN =

Ua koi mai oia no keia wahi Pahale ma Honolulu, ma Hona ma ka Moku o Oahu, no ka mea, ua loa ia iia keia wahi, no M. (C)ekwanawa mai i ka makahiki 1837 mai, a ua noho oluolu no oia ma ka wahi a hiki i kona make ana, i ka makahiki 1849, hooilina keia wahi iia mo ka hana kane, a ua make o M., a ke noho nei no na hooilina ma keia wahi. He wahi nua keia i hooiaapaa nuiia no ke koi ana mai a S. Kaapuni ke hooilina o Hanaki; no ka mea, ua noho pu no o Kaauomoana a me Hanaki ma keia wahi a Kaauomoana i koi mai nei, a ua like hwi ka manawa o ka loa ana ia lala, ma ka makahiki 1837, a ua kuku like no i na hale a hana no hoi i ka pa, a ua noho no ma ka wahi a hiki i ka make ana. A no ka nui o ka hooiaapaa ana a me ke aumeume ana i wai o lala, a no ka holo ole i wai o na awa elua, no hoi ua hooiaapaa hiki hui mau hana o makou e make e like me keia hui i hoi keia malalo, a ua a like na awa elua ma ia Mahela ana, aole ke aumeume hoi a hiki i keia la.

Oia ka makou e hooi nei no Kaauomoana a i kona mau hooilina, ke kuleana hoi kona malalo iho o ke Aw-Atadio. Ina e ukui mai oia i ke Aw-Atadio, a hoi, ua kupaia ia i ka Palapala Lila Atadio.

Ino nae iia i ke ukui no ke hooi holo holo a me ka hooi holo ana i ka olelo. Penei

G. M. Robertson
 J. M. Smith
 W. L. Lee
 J. K. Kaulahao

No ka nui a me ke pa ana i ka olelo ma ka Muepa
 No ke kope iwa i ka olelo koina
 No ka palapala hui
 No ka hana ana i ka la 25 & 26 o Maraki 1850
 No ke kope ana i na olelo a na hoi, 3 Aw
 No ke ana ana i ka la 29 o Maraki 1853
 No ke kope ana
 No ka hooi holo ana i ka olelo i ka la 6 o Aperila 1853.

Oia na palapala.

Anaia e S. Kaulahao

Pahale ma Honolulu, Hona, Oahu

O hooiaapaa ma ke hiki Komohana o keia Pahale i pili ana ma ke Alanui Smith, ke hiki Akau o ka Pahale o ka Poe (Misionari Farani, a e holo Akau 52 Hikiina 50 Pauku ma ka hiki Kama o ke Alanui Smith a hiki i ke S. Kaapuni. A hoi Kama 45 Hikiina 79 Pauku ma ke S. Kaapuni a hiki i ke Kuakolu, a hoi Kama 24 (Kom. 63 Pauku ma ke Kuakolu, hiki i ke hiki Hikiina ma ke o ka pa o na Misionari Farani, a hoi Akau 40 30 Komohana 109 Pauku ma ka pa Misionari Farani a hiki i ka hooiaapaa ana.

Makou o keia Pahale 62 Ana

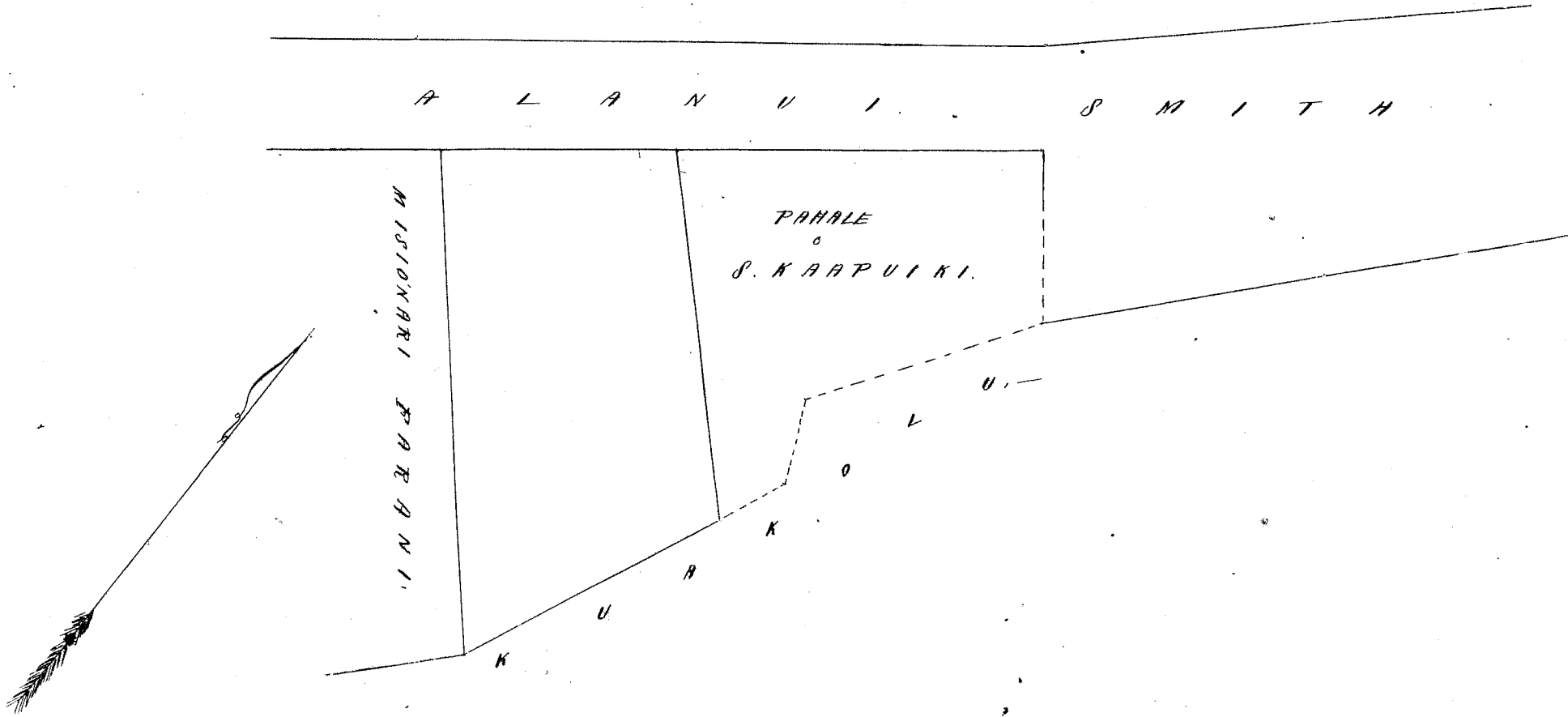

66 FEET = 3 INIHA.

Koleu 1074 Amihia

Mai 453 Bute 2 mai.

Ua koi mai oia no kona wahi ma Hea i Honolulu ma Kona ma ka Mokupuni o Oahu, no ka mea, ua loa ia ia keia wahi no Kahakili mai i ka manawa no e ola ana o Hinawi, a wa noho keakea oleia a hiki i keia manawa.

Oia ka makou e hooke-mai no Amihia, he kuleana hoi korou matato iho o ke Ano Alodio Ina e utu mai oia iho ke Kupuni hapaha; aiaita, wa kepono ia ia ka Palapala Sila Alodio.

Tono nae ia ia ke utu no ka hooke-hoko a meka hooke-ana i ka olelo. Penei, -

- W. L. Lee
- J. M. Robertson
- J. H. Smith
- J. Kekaulaha

No ka rumi a me ke faai ana i ka olelo ma ka Muepea

No ke kope ana i ka olelo koina

No ka palapala kii

No ka hana ana i ka law 5 o June 1848

No ke kope ana i wa olelo a ma hoi ke 1/2 law

No ke ana ana i ka law 6 o November 1852. - Ukuia ke ana \$5.00

No ka hooke-ana i ka olelo i ka law 6 o Aperila 1853.

Ken

Oia ma palena.

Amia e S. Kalama

3 00

Aina ma Hea, Honolulu, Kona, Oahu.

5 Loi a me Sila o Hale. E hoomaka ma ka hoihona x matato o ka faapohaku ma ke kiki Komohana Hea o keia aina e fili ana meka aina o Punini, Ue holo Hea 48° Hikina 5 Kaulaha iho a hiki ma ka fa-aina matato, a me Hea 68° 30' Hikina 34 Pautu hiki pohaku fa mvaluna o ka auwai, a me Hea 19° 30' Hikina 58 Pautu a me Hea 54° Hikina 2 3/4 Kaulaha a me Hea 59° Hikina 112 Pautu e fili ana me ka Punini a hiki i ke kiki Hikina Hea o keia aina e fili ana me ka aina o ke Kupuni. - Aiaita Hea 34° Kom. 135 Pautu a me Hea 60° Kom. 219 Pautu a me Hea 68° 30' Kom. 58 Pautu e fili ana meka aina o ke Kupuni a hiki i ho Kahinalua. - Aiaita Hea 53° Kom. 2 Kaulaha, a me Hea 49° Kom. 390 Pautu hiki pohaku x a me Hea 35° Kom. 163 Pautu ma ka palena o Kahinalua a hiki i ka hoihona x alua ma ka faapohaku ma ke kiki Komohana Hea ma ka i o keia aina. - Aiaita Hea 63° Hikina 1 1/2 Kaulaha ma ka faapohaku e fili ana meka aina o ke Kupuni a hiki i ka hoihona i hoomaka i Ma ia Aina 1 5/10 Eka.

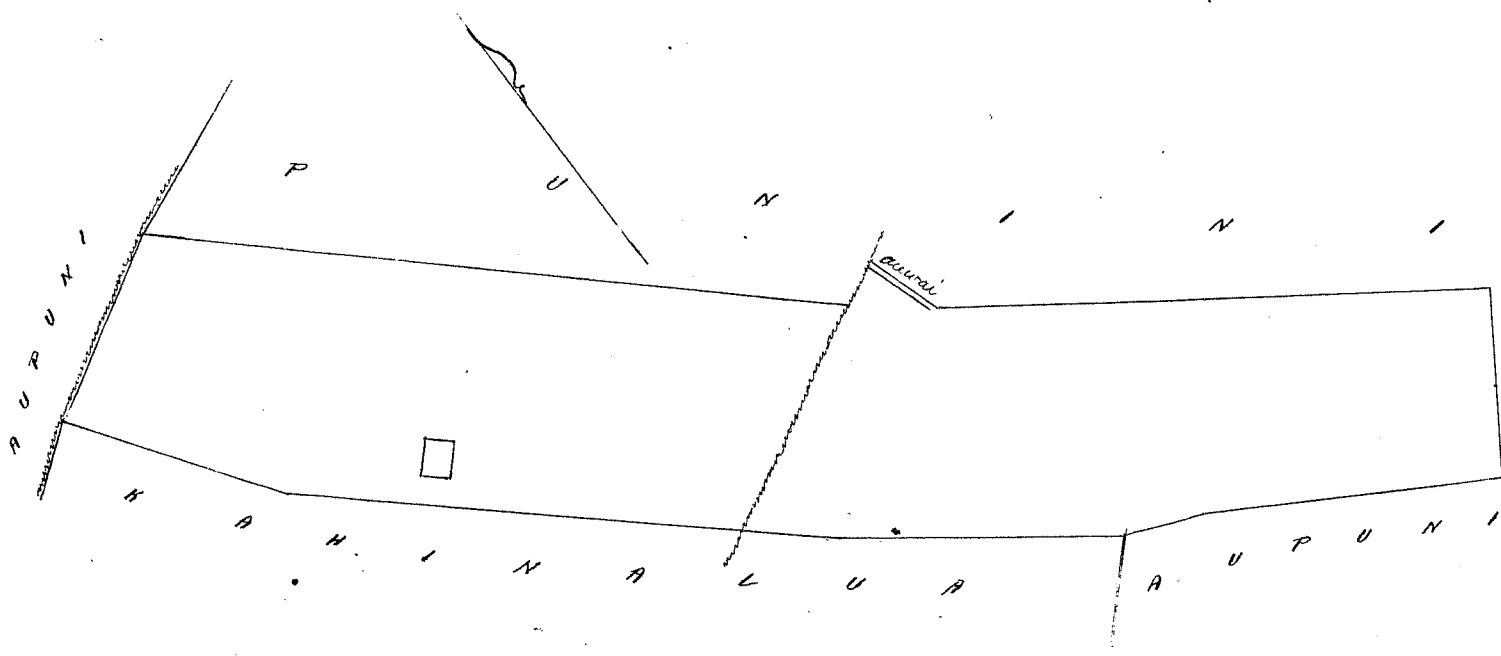

Koleu 4677 Tuaiti

Ua koi mai oia no kona mau wahi ma Kalia & Kamakela i Honolulu, ma Kona, ma ka Mokupuni Oahu; no ka mea, ua loa ia ia keia mau wahi, no Nakoheo mai ka Apana aina kato i ka manawa e ola ana o Hinawi, a no kona mau kupuna mai ka Apana Kahualae, a wa noho keakea oleia a hiki i keia manawa.

Oia ka makou e hooke-mai no Tuaiti; he kuleana hoi korou matato iho o ke Ano Alodio Ina e utu mai oia iho ke Kupuni hapaha; aiaita, wa kepono ia ia ka Palapala Sila Alodio. Tono nae ia ia ke utu no ka hooke-hoko a meka hooke-ana i ka olelo. Penei, -

- No ka rumi a me ke faai ana i ka olelo ma ka Muepea.
- No ke kope ana i ka olelo koina
- No ka palapala kii

W. Lee
J. Kekaulahas
G. M. Robertson
O. S. Smith

No ka hana ana i ka la 14 o Feberuari 1853.
No ke kope ana i na olelo a ma hoike, 1 Awa
No ke ana ana i ka la 26 o Marama 1853. - Ukuia ke ana \$4.00
No ke kope ana
No ka hoo holo ana i ka olelo i ka la 6 o Aperila 1853.

\$ 3 00

Oia ma palena.

Anaia i A. Kalamia

Aina ma Kalio (Kamakela, Honolulu, Kona, Oahu.

Apana 1. Kahakala ma Kalio. E hoomaka ma ke kiki Komohana, a i holo Kona 37 Hikiina
68 Paku, kiki, a me Akau 52° Hikiina 68 Paku me W. L. Lee, a hiki i ke Alanui Beretania ma Kahawai
o Kamakela, - Alaila Akau 34° Kona 70 Paku ma ke kiki makai o ia Alanui, kiki, - a i ka Kona 58° 30'
Kona 72 Paku me W. L. Lee a hiki i ke hoomaka ana Ma ia Apana 60 Anana

Apana 2. Makena Loo ma Kamakela. E hoomaka ma kuauna Hikiina, ma ka palena o Kuleleau-
moku, a i holo Kona 4 1/2° Kona 292 Paku, a me Kona 58° 30' Kona 53 Paku ma kuauna o keia me
Kula Komohiki, - Alaila Akau 67° Kona 120 Paku a me Akau 17° Kona 46 Paku me Kuleleau a me
Palila, - Alaila Akau 13° 15' Hikiina 146 Paku, a me Akau 12° Kona 27 Paku me Palila a hiki i ke
paku makena Loo, - Alaila Akau 89° 15' Hikiina e oki ana i ka Loo e kaawale ai ke Kuleleau moku
a me keia a hiki i ke hoomaka ana. Ma ia Apana Aina 420 1/2 Anana, = Paku a
480 1/2 Anana.

E, he wa keia, aia ke pono ma ka Awa 563.

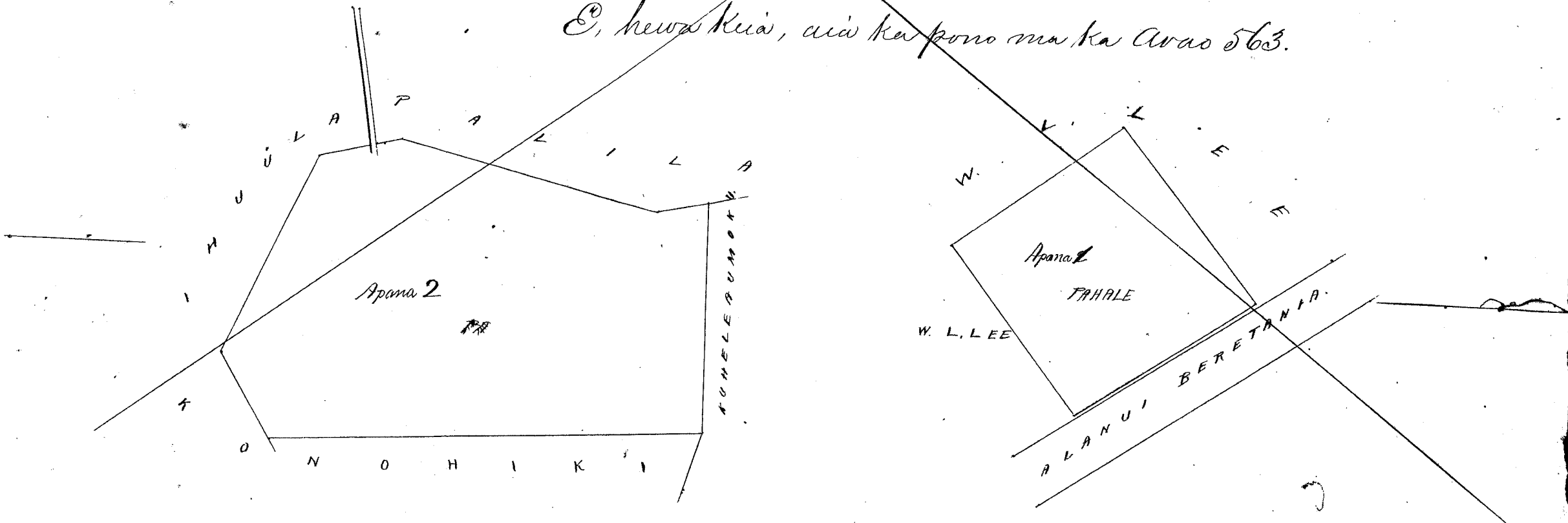

Kele 1662 37119 Uilama Keenery Kahaolemahia'i

Ua kei mai oia no kona wahi Pahale ma (Kawaiakao i Honolulu ma Kona, ma ka Mo-
kupuni o Oahu, no ka mea, ua loa ia ia keia wahi i ka manawa o Kaahumanu, ke waiho wale iho
no keia wahi ia manawa, a no hana no me kona kaitiavana o Kaupuni a i pa a pa a i keia wahi
hoi i wa hale, a ua maku o Kaupuni, a o Kapokini ke kiki a Kaupuni ma ke Kaupuni
wahi, a ua noho mau no o W. H. Kahaolemahia'i ma kona wahi a hiki i keia manawa, Aka, ua kele
mai o Kapokini ke kiki a Kaupuni, e hoole i ke kuleana o W. H. Kahaolemahia'i ke kaitiavana hoi
o Kaupuni, aka, i ke makou mana ana i na olelo hoike, ua hooa ia W. H. Kahaolemahia'i a me
Kaupuni i ka manawa o Kaahumanu, ua noho like me ke kua ole kekahi i kekahi, a ua hana
no o W. H. Kahaolemahia'i i na pa a me wa hale malua o keia wahi ana i hoi mai nei, a ke
noho mau nei no malaila a hiki i keia la. Nolaila, ua kele aku kekahi mau Lima o makou e
makena i keia wahi a hana e aumeume nei, a ua makena iho e like me ka mea i holo i ke makou
no no ana, e like me ke kii i hoikeia malalo nei, a ke noho oluolu nei a hiki i keia manawa

Oia ka makou e hooke nei no W. H. Kahaolemahia'i; ke kuleana hoi kona malalo
iho o ke Awa Alodiv. Awa e uku mai oia i ke ke Kupuni hapaha; alaila, ua kupo ia ia ka
Palapala Ili Alodiv.

Tono mai ia ia ke uku no ka hoo holo a me ka hoo holo ana i ka olelo. Penei, -
No ka mea a me ke pa'i ana i ka olelo ma ka Mupapa.
No ke kope ana i ka olelo kina

W. Lee
G. Robertson
J. Kekaulahao
J. H. Smith

No ka palapala kii
No ka hana ana i ka hua 12 o October 1849
No ke kope ana i na olelo a ma hoike 1/2 Awa
No ke ana ana i ka hua 29 o Maraki 1853.
No ke kope ana
No ka hoko ana i ka olelo i ka hua 6 o Aperila 1853.

Eia na palena

\$ 600

Anaia o S. P. Kalamo

Pahala ma Kawaiahae, Honolulu, Kona, Oahu

E hoomakau ma ke kiki (Kikina) o keia Pahala a fili ana me ka kiki Kona o ka Pahala. Maalahia iwa ka lili Akau o ke Alanui Alapai, a e kolo i ka Akau 53 Degere Komohana 170 Pautu ma ka pa o Maalahia a hiki i ke kiki (Kikina) o ka pa o ma Hoilina o Ukalimou, - Alaila kolo i ka Kona 32 Degere Komohana 260 Pautu ma ka pa o ma Hoilina o Ukalimou a hiki i ka lili mauka o ke Alanui Alui a hiki ana i (Waikiki), - Alaila kolo i ka Kona 85 1/2 Degere (Kikina) 163 Pautu ma ka lili mauka o ia Alanui a hiki i ke Alanui Alapai Alaila kolo i ka Akau 66 1/4 Degere (Kikina) 31 Pautu, - a i ka Akau 35 Degere (Kikina) 144 Pautu ma ka lili Akau o ke Alanui Alapai a hiki i ka lili i hoomaka i ke ana ana.
Makou o keia pa 403 Anama.

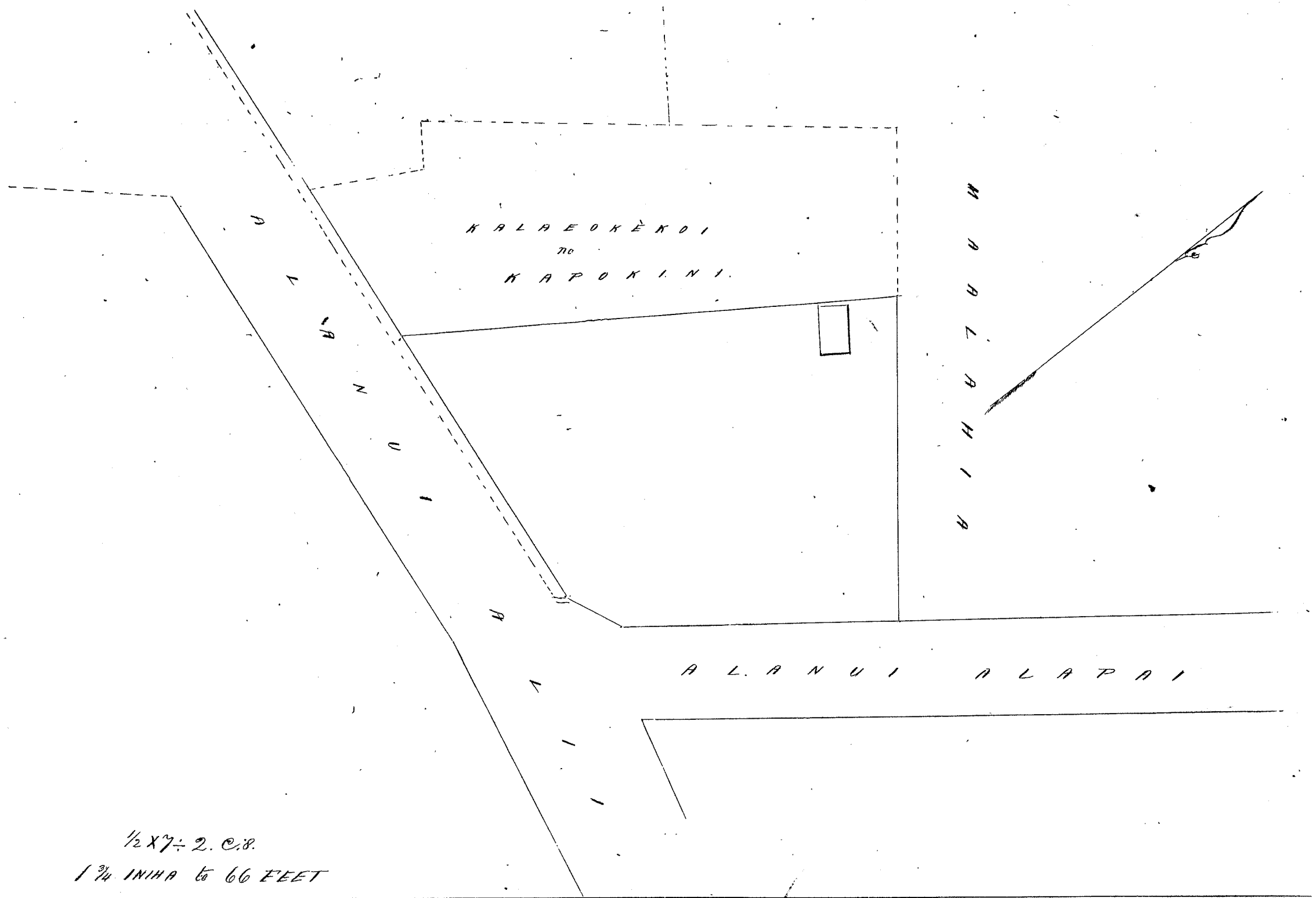

Kele 1151 Kuewa

Ua koi mai oia no kona wahi ma Haukahu o Kona ma Honolulu, ma Kona, ma ka Mokupuni o Oahu, no ka mea, waloa ia ia keia wahi no Haeku i ka manawa o Peki e ola ana, a wa waho keia oia a hiki i keia manawa.
Oia pa ma kou e hoko mai i ke Kuewa; he kuleana, he kona malalo iho o ke Alo Alodio. Ima e uku mai oia i ke ke Kupuni kapahia; alaila, wa kupuna ia ia ka Palapala Pila Alodio.
Iono ma ia ia ke uku ana no ka hoko kolo a me keia hoko ana i ka olelo. Ima

No ka rumi a me ke paia ana i ka olelo ma ka Nupapa
No ke kope ana i ka olelo koina

W. Lee
G. M. Robertson
J. Kekaulaha
J. H. Smith
O. Isoni
Oia ma palena.

No ka palapala kii
No ka hana ana i ka la 27 o Ianuari 1851.
No ke kope ana i wa o le a ma hoike 1/2 Awa.
No ke ana ana i ka la 29 o October 1852. Ukuia ke ana #5.-
No ke kope ana
No ke hoo holo ana i ka olelo i ka la 6 o Aperila 1853.

\$ 5 00

Anaia o S. Kalama

Ana ma Kaukaiohu, Kuuana Honolulu, Honu, Oahu.

I Loi o Kahuahala o Kula Mahiai. E hoomuku mau ke kiki Akau o keia ana, e fili ana ma ke kiki Komohana o ke Iwi o ka hiki i ke ana mau ke papohaku, A e holo ma ke ana A. G. Thurston Kona 55° 15' Hikiina 172 Pautu, a me Kona 39° Hikiina 380 Pautu ma ke palena o Iwi o ka hiki i ke papohaku o J. Phillips. - Alaila Kona 54° 45' Kona 123 Pautu, a Kona 67° Kona 57 Pautu, a Kona 52° 50' Kona 250 Pautu, a Kona 55° 45' Kona 113 Pautu ma ke papohaku o J. Phillips a hiki i ke kiki Hikiina o ka hiki Apapa Ana o J. Dawson, Alaila Akau 67° 45' Kona 176,000 Aulahu ma ka palena o James Dawson a hiki i ke kiki Komohana o keia, - Alaila Akau 19° Hikiina 260 Pautu, a malaila aku i ke ma ke papohaku o keia e fili ana me ka hiki Alanui Anuanu a hiki i ke hoomuku ana. Iko o ia Ana 2 1/2 Eka

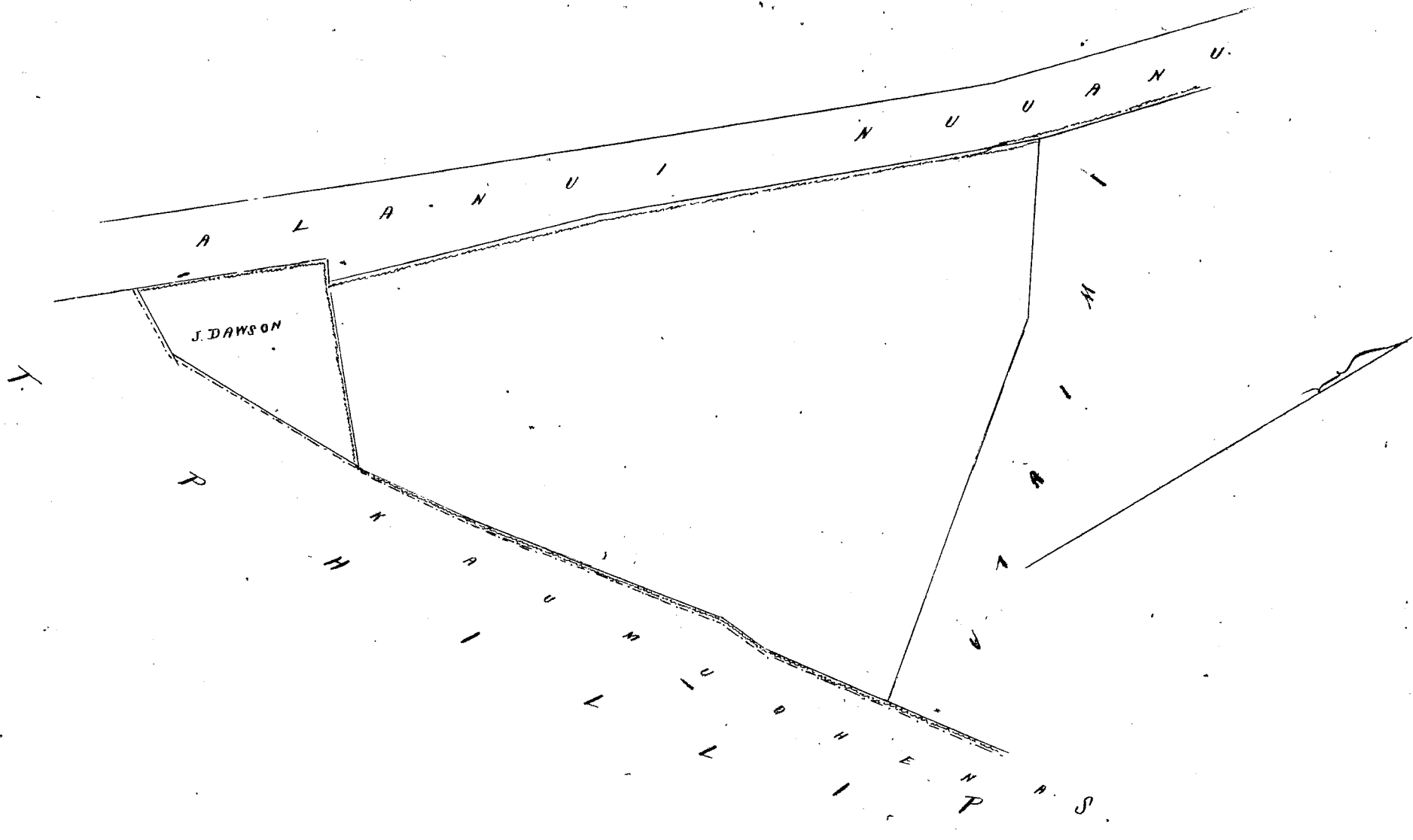

Heleu 11078 Hawaiiolo

Ua hoo ma oia no kona mau wahi ana Hawaiiolo i Honolulu ma ke Moku o Oahu ma keia mea; wa hoo ia ia keia mau wahi no Keawelua i ka makahiki 1840 a ua hoo oia i ka hiki i ka la 16 o Sepatemaba 1851. Keakea mai ia ka Moku Komohana ma keia, no ke kiki Loi ana e fili ana i ke Alanui Anuanu, a i ka hoo paapaa ana imua o makou mo wa Lou la wa hoo holo i ke makou i ke ma a pono. Wa ko ka keakea a ke Alii, a o keia mau Apapa i ke keia maabalo nei; oia wale no ke Hawaiiolo kuleana a makou e hoo ko aku ai.
Oia ka makou e hoo ko nei no Hawaiiolo, he kuleana hoo kona maabalo iho o ke Ano Alaila. Ana e uku mai oia i ke keia Anuanu hoo paapaa; alaila, wa hoo pono ia ia ka Palapala Lila Alodiu.
Pono ma ia ia ke uku no ke hoo holo holo a me ke hoo holo ana i ka olelo. Pono -

W. Lee
G. M. Robertson
J. H. Smith

No ka rumi a me ke pui ana i ka olelo ma ka Nupepa
No ka kope ana i ka olelo ko'ina
No ka palapala kii
No ka hana ana i ka la 2 o Oct. 1850 & 16 o Sept 1851.
No ke kope ana i ma olelo a ma hoike 1/2 Awar
No ke ana ana i ka la
No ke kope ana
No ka hoo'olo ana i ka olelo i ka la 6 o Aperila 1853.

J. Kekaulahao

Eia ma palena

Anaia e A. F. Turner

\$ 5 00

Apana 1. 3 Loi ma Auwailimu, Honolulu Aina, Oahu.

E hoomaka ana ke kiki Hema, a e holo ana

Mk 39 1/2	Ko. 224	pa'au e pili ana i ke Panakahi
Mk 23	Ko. 134	" " Pipili
Ke. 55	Ko. 74	" " "
Ke. 27	Ko. 107	" " Hema
Ke. 47	Ko. 182	" " "
Ke. 72	Ko. 78	" " Kahawai a i ke kiki mua. 21/100 Eka

Apana 2. 2 Loi ma Auwailimu, Honolulu Aina, —

E hoomaka ana ke kiki Hema, a e holo ana

Mk. 50	Ko. 233	pa'au e pili ana i ke Kaumehameha
Mk 38	Ko. 82	" " Keoho
Ke. 48	Ko. 229	" " Co
Ke. 33	Ko. 76	" " Pipili a i ke kiki mua. 18/100 Eka

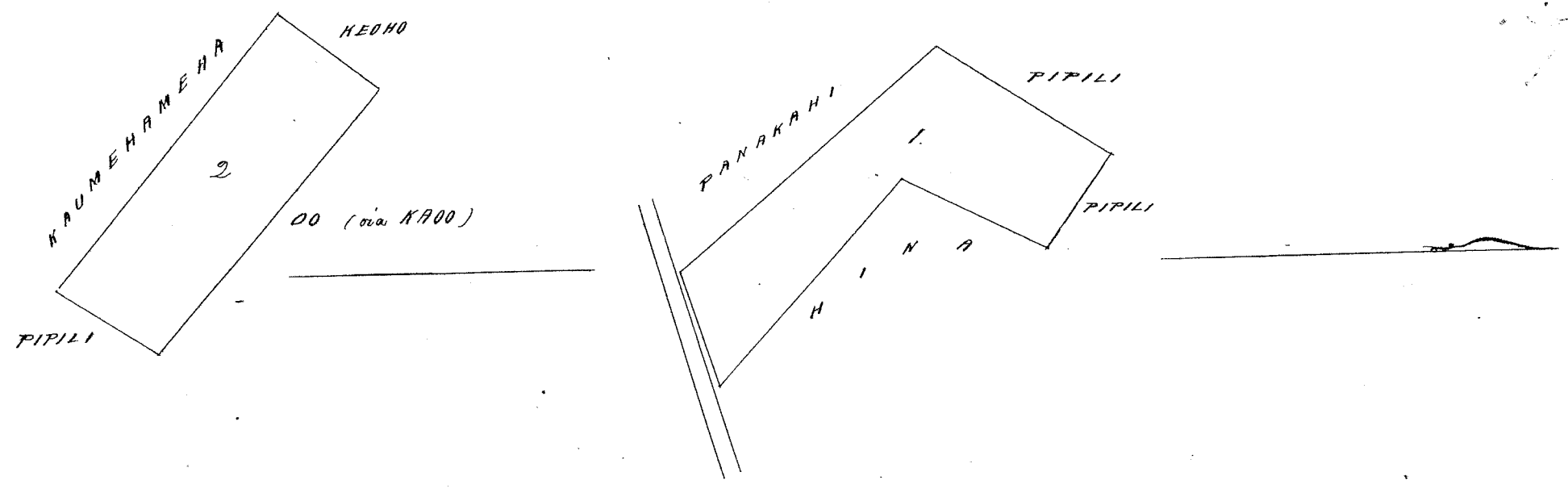

Hele 1075 Umi

Ua koi mai oia no kona wahi ma Kahawai i Honolulu Aina ma Hona, ma ka Moku'uni o Oahu; no ka mea, ua loa ia ia keia wahi no Kaailaau maikana kaikamahine M.H. 1847, a ua loa hoi ia Kaailaau no Kahouiki, mai i ka makahiki 1846, a ua noho keakea oleia a hiki i keia manawa.

Oia ka makou e hoo'olo ai no Umi; he kuleana hoi kona amata iho o ke Awa Alodiv. Ana e uku mai oia i ke ke Aupuni hapahapa; alaila, ua kupo ia ia ke Palapala Lila Alodiv.

ono mai ia ia ke uku no ka hoo'olo kolo a me ke hoo'olo ana i ka olelo. Penei

W. Lee
G. M. Robertson
J. H. Smith
J. Kekaulahao

No ka rumi a me ke pui ana i ka olelo ma ka Nupepa
No ke kope ana i ka olelo ko'ina
No ka palapala kii
No ka hana ana i ka la 5 o June 1848
No ke kope ana i ma olelo a ma hoike Awar
No ke ana ana i ka la
No ke kope ana
No ka hoo'olo ana i ka olelo i ka la 6 o Aperila 1853.

Ken.

\$ 11 00

Ka mokeko Kahawai ili o Kahawai, Honolulu, Oahu.
 E hoomaka ma ke kiki Komohana, e hulu ana Heema 34' Hik. i 1. 03 kh. ma ke palena no Oloa. Ma'aila aku Ak. 45' Hik. i 1. 46 kh. ma ke palena no Kahouiki. Ma'aila aku Heem 39' Hik. i 0. 90 kh. Ma'aila aku Ak. 48' Hik. i 1. 07 kh. ma ke palena noe. Ma'aila aku Heem 47 1/2' Hik. i 2. 18 kh. Ma'aila aku Ak. 36 1/2' Hik. i 0. 70 kh. ma ke palena o Kupaulakea. Ma'aila aku Ak. 43 1/2' Kom. i 3. 50 kh. ma ke palena no Chaco. Ma'aila aku Ak. 43 1/2' Kom. i 3. 30 kh. ma ke palena no Kahawai a hiki i ka hoomaka ana. He 6 25/100 kh. huiiaka

A. Bishop
 Mea Ana

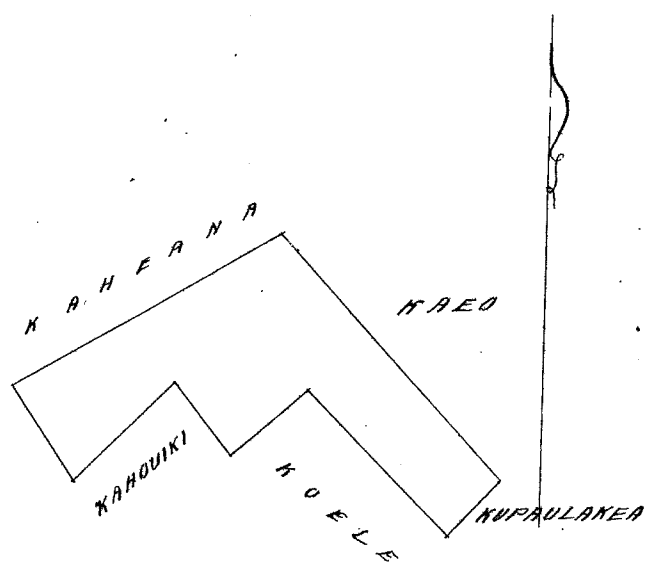

Heleu 8863 I Kekaulahao

Ua kwi mai oia no kona wahi Apama Aina kato ma Kulu i Honolulu ma Kona, ma ke Mokupuni o Oahu; no ka mea, ua loa ia ia keia wahi no Mr. Haina mai kona makuakane i ka maha-hiki 1841, a ua loa hoi ia Mr. Haina no Hainau mai i ka maha-hiki 1831, a ua mohe mai no me ke hea-kea oia a hiki i keia manawa.

Oia ka maku e hooke me no I. Kekaulahao; ke kuleana hoi kono, ma lalo iho o ke ana Aloha. Ina e ukui mai oia i ke ke Kupuni Kupaha; alaila, ua kupo ia ia ke palapala Ilo Aloha.

Nono mai ia ia ke ukui, no ka hoohele a me ka hoohele ana i ka oleo. Penei,

- W. Lee No ke rumi a me ke paai ana i ka oleo ma ke Kupaha
- G. M. Robertson No ke kope ana i ka oleo kono
- J. H. Smith No ke palapala hui
- I. Kekaulahao No ke hana ana i ka la 25 o Novemaba 1851
- I. Kekaulahao No ke kope ana i ka oleo a ma hiki 1/2' Aoa
- I. Kekaulahao No ke ana ana i ka la 27 o Novemaba 1851. Ukuia ke ana \$4.00.
- I. Kekaulahao No ke kope ana
- I. Kekaulahao No ke hoohele ana i ka oleo i ka la 25 o Aperila 1853.

\$ Kono

Cia ma palena.

Aina e I. Kalama

Apama Aina kato ma Kulu i Honolulu Kona, Oahu.
 E hoomaka ma ke kiki Akau o keia aina e pili ana me ke kiki (Kokina) ma ke o ke Mr. Haina, a e holo Heema 53 1/2' Hik. 283 kapuai ma ke palena o Kapouhuluhulu, a hiki i kahawai, alaila iho i ka ma kahawai iwaena o keia a me Palikea a hiki i ke pohaku i hoailonaia B ma ke kiki Akau o ia kahawai; alaila Akau 51' Kom. 88 kapuai o Akau 39' Kom. 106 kapuai, a me Akau 49' Kom. 126 kapuai ma ke palena o Chaco no Kupuni a hiki i ke kiki Heema o ke Mr. Haina. Alaila Akau 39 1/2' Hikina pololei i ka ma ke palena o keia me Mr. Haina a hiki i ka hoomaka ana.

Ma ia Apama 1 Eki 96 Amana 10 Kapuai.

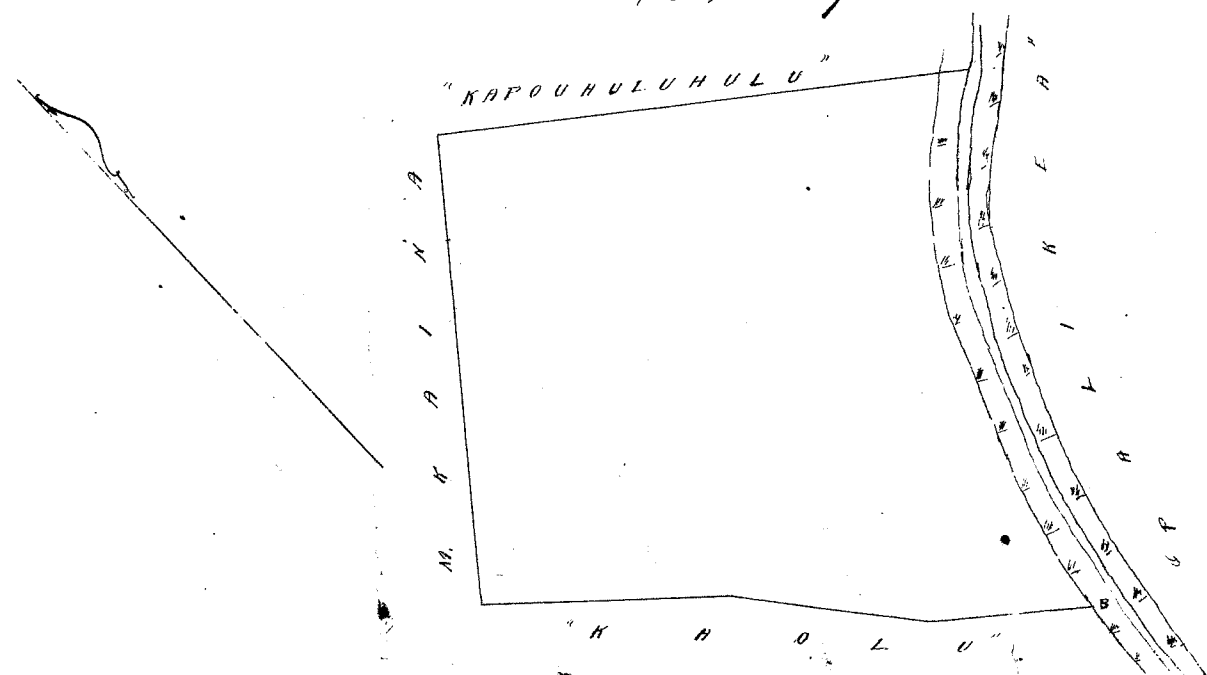

Helu 3761 B Katuaopele

Na koi mai oia no kona wahi ma ke Ahupuaa o Haleu ma Lahaina ma ke Mokupuni o Maui, no ka mea, ua loaa ia i keia wahi no (Hekelelike mai ke Honohiki i ke manawa o ka hana ana i ka Papu o Lahaina, a ua noho heakea oia a hiki i keia manawa.

Oia ka makou e hoohe nei no Katuaopele, ke kuleana hoi kona maabalo iho o ke Aho-Abdio. Ina e uku mai oia i ke ke Aupuni kaupaha; alaila, ua kupo no ia ia ka palapala Sila Abdio.

Pono maia ia ke uku no ka hoohelele a me ka hoohelele ana i ka olelo. Penei-

W. L. Lee
G. M. Robertson
O. H. Smith
J. Kekaulaha

No ka runni a me ke pui ana i ka olelo ma ka Muepepa.
No ke kope ana i ka olelo kiina
No ka palapala kei
No ka hana ana i ka la 26 o Aperila 1853.
No ke kope ana i ma olelo a ma hoohe 1/2 Awar
No ke ana ana i ka la Ukuia ke ana \$1.00
No ke kope ana
No ka hoohelele ana i ka olelo i ka la 28 o Aperila 1853.

\$ 4 00

Eia ma palena

Anaia e H. J. Alexander

\$ 4 00

Aia kona kuleana ma ke Ahupuaa o Haleu ma Lahaina, Maui.

E hoomaka ana ma ke kihi Kama a e holo ana

Akau 45 1/4	Komohana	1.56	Kaulaha e pili ana me Alamui Hou
Akau 49	Kiina	0.69	Umuuni
Kama 35	Kiina	0.87	Nakole
Kama 53	Komohana	0.25	"
Kama 39	Kiina	0.71	"
Kama 50 1/2	Komohana	0.21	"

Keia Umuuni ma ka hoohelele ana i ka la 28 o Aperila 1853.

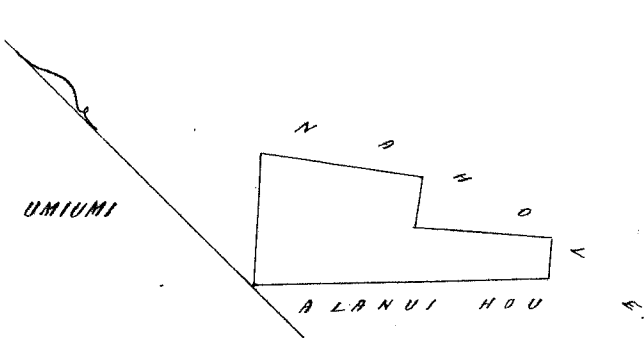

Helu 7762 Kaninaualii

Na koi mai oia no kona wahi ma ke Ahupuaa o Haleu ma Lahaina i Maui, no ka mea, ua loaa ia i keia wahi no (Kalaokua mai i ke manawa e noho Linaauhau ana o J. Kamakini no Lahaina, a ua loaa hoi ia Kalaokua no Kama mai, a ua noho oia ma me ke heakea oia a hiki i keia manawa.

Oia ka makou e hoohe nei no Kaninaualii, ke kuleana hoi kona maabalo iho o ke Aho-Abdio. Ina e uku mai oia i ke ke Aupuni; alaila, ua kupo no ia ia ka palapala Sila Abdio.

Pono maia ia ke uku no ka hoohelele a me ka hoohelele ana i ka olelo. Penei-

W. L. Lee
G. M. Robertson
O. H. Smith
J. Kekaulaha

No ka runni a me ke pui ana i ka olelo ma ka Muepepa.
No ke kope ana i ka olelo kiina
No ka palapala kei
No ka hana ana i ka la 24 o Maraki 1853
No ke kope ana i ma olelo a ma hoohe 1/2 Awar
No ke ana ana i ka la 26 o Februari 1853. Ukuia ke ana \$1.50
No ke kope ana
No ka hoohelele ana i ka olelo i ka la 2 o Meei 1853.

\$ 3 00

Eia ma palena

Anaia e L. S. Wa.

\$ 3 00

Ke ana ana i kekahi Apana aina kula o Kanihauai i wahi ana ma ke Ahupuaa o Aupohoku ma Lahamaia ma
E hoomaka ana ma ke kiki Akau Komohana o keia aina ma keahi ipili ai ia Kahapuna a me ke
kahuwai, a e holo ana

Kona 6'	Kikina	1.41	Kaulahao e pili ana ia Kahapuna
Kona 80 1/2'	Kikina	1.68	" " " " " " " "
Akau 72'	Kikina	1.31	" " " " " " " "
Akau 19 1/4'	Komohana	0.87	" " " " " " " "
Akau 81'	Komohana	2.80	" " " " " " " "

Kahawai a hiki i kahi i hoomaka ai.

Ka ili 1 Buda 17 Roda.

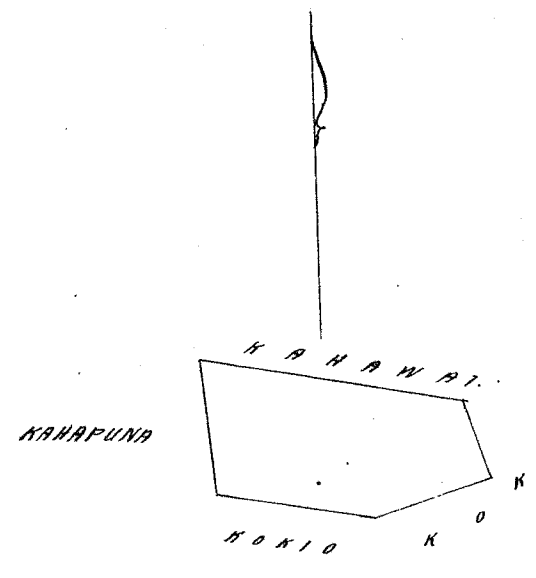

Kele 9925 Lonoaea

Ua hoi mai oia ma kona wahi aina ma Kawananakoa Kaolu i Honolulu ma Kona, ma ke Mo-
kupuni o Oahu. no ka mea, ua hooa iaia keia wahi no Kanihauai mai i keia manawa e ole o Kihau,
mamua ahu o ka maku ana i ka M.H. 1839, a ua wahu keakea oleia a hiki i keia manawa.

Chia kai maikou e hooke me i Lonoaea, ke kupaana hoi keia imalalo iho o ke ano Mo die. Ina e hoo-
mai oia i ke ke Aupuni kupaana, a hiki, ua kupaana ia ia ka Palapala Lela Mo die.
Iono ma iaia ke wahu no ka hooke hooke a me ka hooke ana i keia olelo. Penei

\$ Sent

- W. Lee
- G.M. Robertson
- C.M. Smith
- J. Kekaula

No ka rima a, me ke pili ana i keia olelo ma ka Mupupu
 No ke kope ana i keia olelo Kihau
 No ka palapala kii
 No ka hooa ana i keia 1 o Iulai 1851
 No ke kope ana i na olelo a ma hooke
 No ke ana ana i keia ka 18 o Maruhi 1852. Ukaia keia ana \$3.00
 No ke kope ana
 No ka hooke ana i keia olelo i keia 7 o Mei 1853.

\$ 3 00

Oia na palapala.

Anaia o S.P. Kalama.

Ma Kawananakoa Kaolu, Muanu, Honolulu, Oahu.
 2 Loi a me Kula. E hoomaka ma ke kiki Kikina ma ke Ala hiki, e pili ana me ka aina o Kanihauai
 a me ke kiki Akau o ka aina o Keawe, Ue holo Akau 26' Kona 96 Panku a me Akau 33' Kona 357 Panku
 e pili ana me ka aina o Kanihauai a hiki imalalo o Kihaua Loi o Iono Kii. Alaila Kona 52' Kona 1 Kaulahao
 a me Kona 17' Kona 28 Panku pili ana me Iono Kii a hiki i keia aina o Kanihauai. Alaila Kona 36' Kikina
 3 Kaulahao ma ka aina o Kanihauai a hiki i ke Keawe. Alaila Kona 88' Kikina 27 Panku, a me Kona
 35' 30' Kikina 110 Panku kiki, a me Akau 53' Kikina 76 Panku pili ana me Keawe a hiki i keia hoomaka ana
 Oia ka Ali 556 1/2 Anana

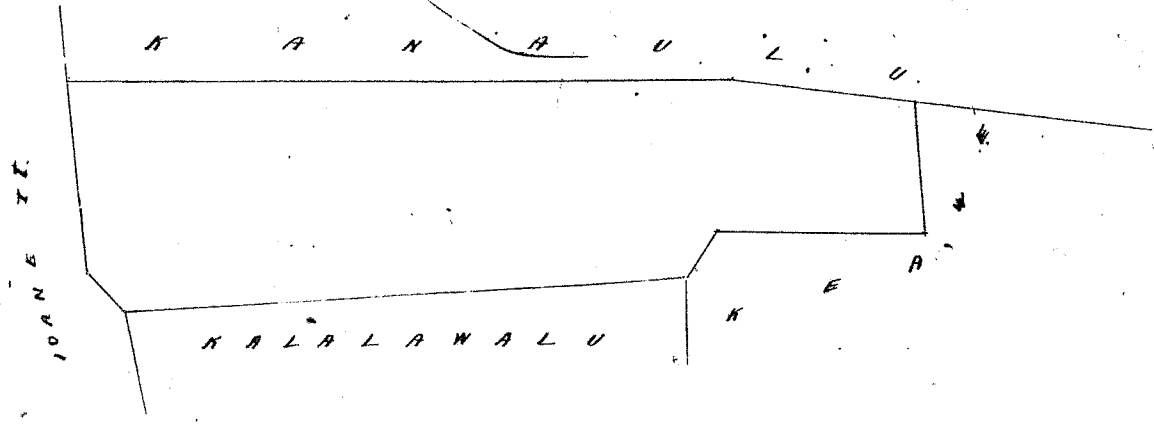

1/2 x 2 = S.C. 100 PANKU = INIHA.

Hele 2045 Kauwahi (no Puniai.)

Ua kovi mai oia no kona wahi Pahale ma Puunui lele Alialia ma Honolulu, ma Kona, ma ka
Mokupuni o Oahu; no ka mea, ua loa ia ia keia wahi no i ka manawa o Kamehameha I, ke wahi waiho wale
no, a mana no i hana i na hale, a ua noho keakea oleia a hiki i keia manawa, a ua hoolilo loa aku oia i
keia wahi ona no Puniai ma ke ano Alodio me kona munas ole i ma mea a pau ana maluna a madoko o keia
wahi ana e hoolilo loa nei no Puniai kama Punaiua.

Oia ke maku e hoko nei no Kauwahi a ia Puniai, ke kuleana hoi kona madoko iho o ke Ano Alodio.
Ia e uku mai oia i ke ke Aupuni hapuwa; alaila ua kufono ia ia ka Palapala Pila Alodio.

Pono nua ia ia ke uku no ka hooloholo a me ka hoholo ana i ka olelo Puni,

\$ Kem.

- H. Lee No ka rumi a me ke paai ana i ka olelo ma ka Nupapa
- G. W. Robertson No ke kope ana i ka olelo koina
- J. H. Smith No ka palapala kii
- J. H. Smith No ka huna i ka la 29 o Aperilo 1853.
- J. H. Smith No ke kope ana i ma olelo a me hoi ke 1/2 Awa
- J. H. Smith No ka ana ana i ka la 28 o Aperilo 1853. Ukuia ke ana \$3.00
- J. H. Smith No ke kope ana
- J. H. Smith No ka hoholo ana i ka olelo i ka la 7 o Mei 1853.

Oia na palena;

Amia e S. P. Kuleana.

\$ 3 00

Pahale ma Puunui lele Alialia ma Honolulu, Oahu.

E hoomaka ma ka pahau kii Akau o keia Pahale, kikoke i ka auwai, a i holo (Kona 32° 15' Nomi.
115 Pautu, a me Kona 10° Nomi. 253 Pautu e hele kikoke ana me ka auwai a hiki i ka pahau kii Komokuna
makai; - Alaila Kona 69° 15' Niki. 1 Kaulahao a hiki i ka pahau ka Loko; - Alaila Akau 21° Niki. 119 Pautu, ma
ka holo Akau 34° Niki. 165 Pautu ma ka Loko a hiki i ka pahau kii Kikina ma ka lili makai o ka Loko
kii; - Alaila Akau 42° 15' Nomi. 180 Pautu ma kaia i puia a hiki i ka hoomaka ana. Ua puni keia aina i ke
ke Honolulu. Loko o ia Pahale 549 1/2 Awa.

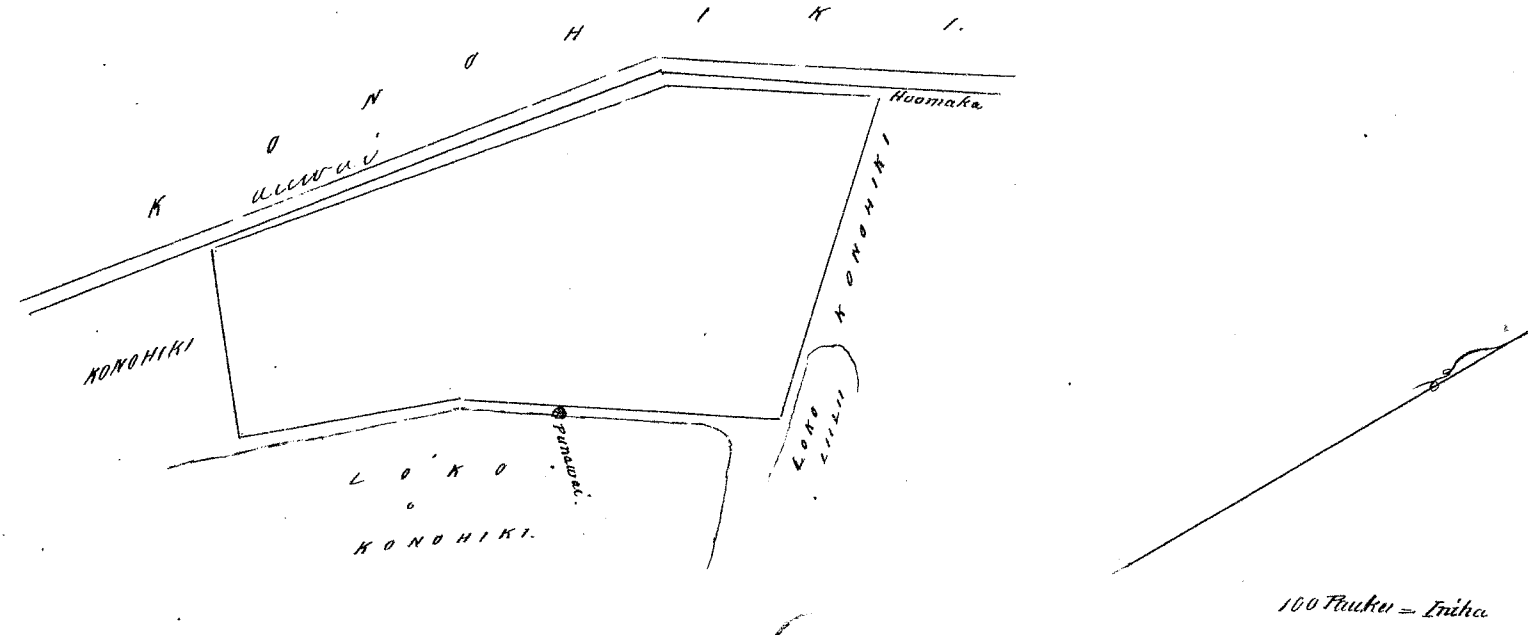

Amia e S. P. Kuleana (no Hele 1352, Kaapua)

Ua kovi mai oia no kona wahi ma Kewalo i Pauu ma Honolulu, ma Kona, ma ka Mo-
kupuni Oahu; no ka mea, ua loa ia ia keia wahi ma Kaapua ma i ka mabana o Oahu 1847
a ua noho no oia mabana a hiki i ka mabana o Sepatemaba 20, 1848. Ke kuleana mae keia i hooa
pua nuiia e Kuleana, no kona kua ana mai i keia hooa ana mai o Amia e S. P. Kuleana, a olelo mai oia, olelo ke
kuleana maopopo o Amia e S. P. Kuleana, no na ke kuleana pono, a fetu ka olelo ana mai o ma hoi ke a me Amia
e S. P. Kuleana, no ka kuleana, a ua hoolohiw "ole kuleana o Amia e S. P. Kuleana ma, aka, o ka iwa e kono ma
ke Amia e S. P. Kuleana, wahi oia o Kaapua," a ua noho keakea oleia a hiki i keia manawa

Oia ke maku e hoko nei no Amia e S. P. Kuleana a lilo ia Kaapua, ke kuleana hoi kona madoko iho
o ke Ano Alodio. Ia e uku mai oia i ke ke Aupuni hapuwa; alaila, ua kufono ia ia ka palapala Pila Alodio.
Pono nua ia ia ke uku no ka hooloholo a me ka hoholo ana i ka olelo Puni.

- No ka rumi a me ke paai ana i ka olelo ma ka Nupapa
- No ke kope ana i ka olelo koina
- No ka palapala kii.

W. Lee
G. M. Robertson
J. Kekaulaha
J. H. Smith

No ka hana ana i ka la 20 & 22 o Epelunaha 1848.
No ke kope ana i ma olelo a nu hoiko 2000
No ke ana ana i ka la 25 o Apelila 1850
No ke kope ana
No ka hoholo ana i ka olelo i ka la 12 o Mei 1853.

\$ 6.00

Eia ma pakuwa

Anaia e A. S. Thurston

Ainu o Amuanui no Kuapua ma Kevala i Paua ma Honohulu, Oahu.
E hoomaka ma ke kiki i ka maikai o keia pili ana me ke Mahina aina. A e holo ana (Ho. 44° 30' Ho.)
1,60 kaul. ma ke (Kalepulu, Keena i ka lima kama 20 fanku, Alaila Kama 41° 45' Ho. 2,30 kaul. a Kama 50° 30'
Ho. 44 fanku ma ke Kalepulu. Alaila ma ke J. Booth loi, - Kama 46° 15' Ho. 33 fanku, a Kama 42° 30' Ho. 1,22 kaul.
a Kama 44° 15' Ho. 1,87 kaul. Alaila Kama 53° Ho. 54 fanku ma ke (Kalaunaia), - Alaila ma ke Kaula Kama 44° 30' Ho.
2,81 kaul. Alaila ma ke Kulu aina Kama 37° Ho. 74 kaul. a Kama 42° 45' Ho. 1,14 kaul. a Kama 44° 30' Ho. 93 fanku
a Kama 31° Ho. 1,46 kaul. hiki i ke kiki i ka maikai o keia, Alaila Kama 48° 45' Ho. 2,23 kaul. ma ke Mahina
aina a hiki i ka hiki i ka maikai i.

Ma ia Apuna 1127 Amawa.

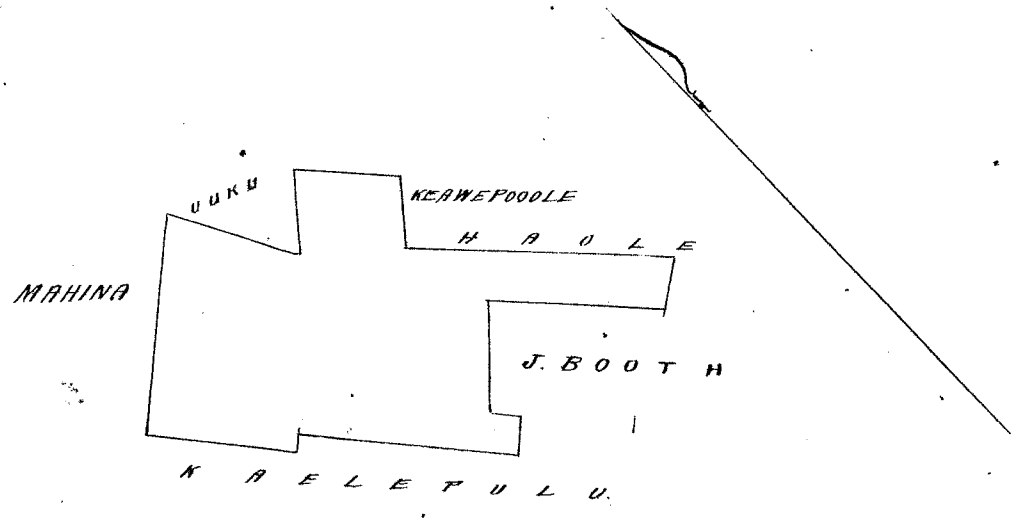

Hele 4878 No Kaiakohokai

Ua hoi mai oia no kona mau wahi aina ma ke Ii o Manawa a me (Kauaia i) Kauaia ma Lohaina
ma ke Motupuni o Maui; no ka mea, ua loa ia ia keia mau wahi no Kekauonohi mai i ka makahiki 1836
a ua noho keakea oia a hiki i keia munawa.
Oia ka maonahi hoko mai no Kaiakohokai; he kuleana hoi kona matulu iho o ke Anu Alodio. Ina e ulu
mai oia i ke ke Aupuni hapaha; alaila, pa kupo ia ia ma Palapala Sila Alodio.
Pono ke mae ia ia ke ulu no ka hoholo kolo a me ka hoholo ana i ka olelo. Penei

W. Lee
G. M. Robertson
J. Kekaulaha
J. H. Smith

No ka maunahi a me ke paia ana i ka olelo ma ke Muepa
No ke kope ana i ka olelo hoia
No ka palapala hii
No ka hana ana i ka la 1 o June 1849
No ke kope ana i ma olelo a nu hoiko 1/2 Awa
No ke ana ana i ka la
No ke kope ana
No ka hoholo ana i ka olelo i ka la 24 o Mei 1853.

\$ 4.00

Eia ma palena.

Anaia e J. P. Alexander

He kuleana aina kona ma ke Ahupuaa o Kauaia ma Lohaina i Maui.
Apuna 1. Aia ma ke Ii o Manawa. E hoomaka ana ma ke kiki i ka Komoana a e holo ana
Kama 31 1/2 Ho. Kikina 2,36 kaul. e pili ana me Kalamo
Kama 70 Ho. Kikina 0,94 " " " " Kahuwai
Kama 38 Ho. Komoana 0,51 " " " " Kapeanani
Kama 35 1/4 Ho. Kikina 0,23 " " " " "
Kama 34 1/4 Ho. Komoana 0,82 " " " " "

Kapaia 69° Komohana 0.23 Kaul. e pili ana me Poepoe
 Akau 29° Komohana 0.88 " " " " " " " " " " " "
 Kema 77 1/2° Komohana 0.87 " " " " " " " " " " " "
 No Ili 37 Roda. Pali i kahi i hoowaka ai.

Apawa 2. Aia ma ka Ili o "Kauia." E hoowaka ana ma kahi (Kema Hikiwa, a e holo ana).
 Akau 3 1/2° Komohana 1.12 Kaul. e pili ana me Kaulaau
 Kema 84° Komohana 2.12 " " " " " " " " " " " "
 Kema 5° Hikiwa 0.94 " " " " " " " " " " " "
 Akau 87 1/2° Hikiwa 2.09 " " " " " " " " " " " "
 No Ili 35 mau Roda. Kahawai i kahi i hoowaka ai.

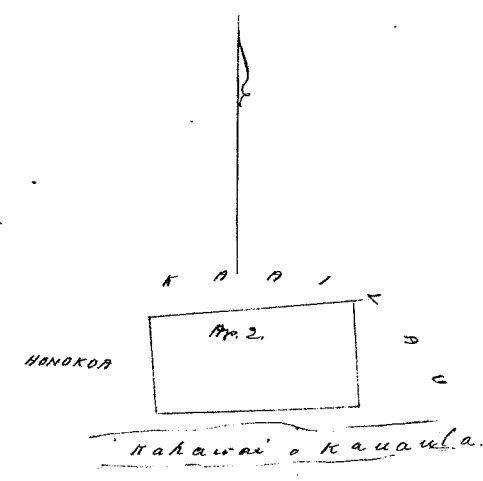
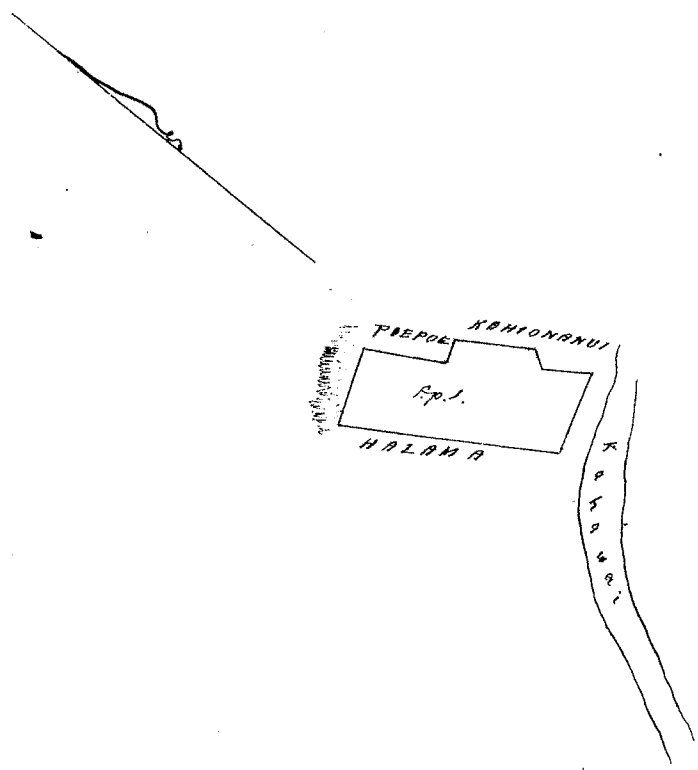

Helu 2065 Keo Bolabola (no Hawaii.)

Ua koi mai oia no kona wahi Pahale ma Kapuikolo i Honolulu ma Iona, ma ka Moku oia o
 Oahu, no ka mea, ua kua ia ia keia wahi no Hawaii muhi kua ma ka honowaihana mai i ka matakiki 1847, a
 ua kua hui ia Hawaii kona makuahonowaihana no M. Kekuanawa mai i ka wa no e ola ana o Kinau i ka
 makahiki 1837. He wahi nae keia i hoowaiho, nuiwa no ke koi ana mai o Kakuwahai; aka, ua kua ia Hawaii
 ka makuahonowai o Keo Bolabola no M. Kekuanawa mai, a no ka mea hoi ke wahi oia mai no ka Kahowai-
 hua me kona noho mau ole maluna o keia wahi; ika, o Hawaii no ka mea e noho ana, a noma me hale e keia nei a hiki
 i keia ka ma na wahi ka.

Oia ka makou e hooke nei no Keo Bolabola a ia Hawaii, ke kua ana hoi kua ma kahi o ke Ano-
 Alodii. Ina e uku mai oia i ke ke Aupuni hapaha; alaia, ua kua ana ia ia ka Palapala Ila Alodii:
 Pono nae ia ia ke uku no ka hookelelele u me ka hookelelelele ana i ka olelo: Penei;—

W. H. C.
 G. M. Robertson
 J. H. Smith
 J. Kekauahua

No ka wahi a me ke pua ana i ka olelo ma ka Nupipa.
 No ke kope ana i ka olelo kinau
 No ka palapala kii
 No ka hana ana i ka la 28 o Marahi 5 o Aperila 1853.
 No ke kope ana i ka olelo a ma kahi 3 Awar
 No ka hana ana i ka la 21 o Mei 1853.
 No ke kope ana
 No ka hookelelelele ana i ka olelo i ka la 31 o Mei 1853.

\$ 5.00

Oia ma palena. Anai e S. P. Kalama.

Pahale ma Kapuikolo, Honolulu, Oahu. E hoowaka ana ka pohaku faakua hoaihanaia ma ka kii
 kai pili i ka, e pili ana me ka pahale o Kahowaiha. A e holo i ka Akau 67° Hikiwa 87 1/2° Kapuai e makela
 ana i ka punawai a hiki i ka pohaku a kua ka prepae hale. me ke kua ma kahi. — Alaia Akau 35° Kom.
 27 1/2° Kapuai pili ia mau awa me ka Kahowaiha a hiki i ke kahi faa o Kahowaiha. — Alaia Kema 56° Kom.
 66° Kapuai me Kahowaiha a hiki i ke kahi ma ke kai pili hapalua ma kahi o ka ee kai. — Alaia kele
 aku ma ka akeai a hiki i ka hoowaka ana. Oia ka Ili 42 Anawa

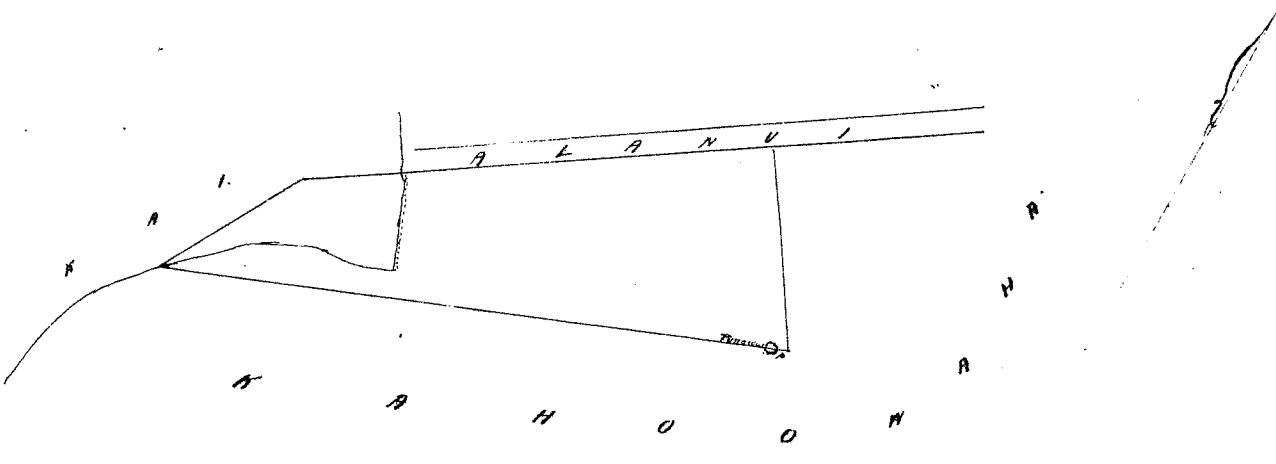

Lot 7113 Keaka (no na Koolina)

Ua hoi mai oia no kona wahi hapalua Koolina ma Manu, ke Koolina iloko o Kailua ma Koolau ma ka Moku o Oahu; no ka mea, ua loa ia keia aina no ka Mo'i Kamehameha III mai i ka mahale aina ana i ka makahiki 1848, a ua noho keakea oia a hiki i keia manawa.

Oia ka makahiki hoohe me i na Keaka; ke kuleana hoi kona mahala iho o ke Aho Modio. Ina e hoi mai oia i ke Aupuni hapaha; alaila, ua kupaia ia i ka Palapala Pila Modio.

Pono mai ia ia ke eku no ka hoohehoho a me ka hoohehoho ana i ka olelo; Penei;

M. Lee
G. M. Robertson
J. Hekeaulaha
J. H. Smith

No ka oomi a me ke paia ana i ka olelo ma ka Moku
No ke kope ana i ka olelo koolina
No ka palapala hoi
No ka hana ana i ka la
No ke kope ana i na olelo a ma hoi
No ke ana ana i ka la Uku o ke ana ana
No ke kope ana
No ka hoohehoho ana i ka olelo i ka la 11 o June 1853.

\$ Ken.

10

\$ 5.
15 00

Oia na palena.

Anaia e A. Bishop

Hapalua Koolina "Manu" ma Kailua, Koolau, Oahu.

Apana 1. Aina wai. E hoomaka mauke hiki Kama e hele ana Ak. 63° Kom. i 7,00 kch. ma Kaahee, Malaila aku Ak. 28° Kom. i 1,20 kch. ma Kapiia. Malaila aku Ak. 39° Kik. i 1,80 kch. ma Kapiia. Malaila aku Ak. 31° Kom. i 4,00 kch. ma Kapiia. Malaila aku Ak. 52° Kik. i 0,80 kch. Malaila aku Ak. 6 1/2° Kik. i 1,50 kch. Malaila aku Kom. 87 1/2° Kik. i 8,20 kch. ma Kaahee. Malaila aku Kom. 6° Kom. i 11,60 kch. maukahaia a hiki i ka hoomaka ana, Ke 8 25/100 Eka.

Apana 2. Ke Kula. E hoomaka mauke hiki Kama e hele ana Kom. 21 1/2° Kom. i 9,00 kch. mauke Aupuna. Malaila aku Kom. 62 1/2° Kik. i 6,66 kch. ma Kaahee. Malaila aku Kom. 35 1/2° Kik. i 2,67 kch. ma Kaahee. Malaila aku Ak. 62 1/2° Kik. i 2,00 kch. ma Manulele. Malaila aku Ak. 14° Kom. i 1,55 kch. Malaila aku Ak. 14 1/2° Kom. i 10,00 kch. mauke Aupuna. Malaila aku Ak. 23 1/2° Kom. i 4,36 kch. a hiki i ka hoomaka ana, Ke 5 29/100 Eka = Pauloa ma Eka

A. Bishop
mea ana.

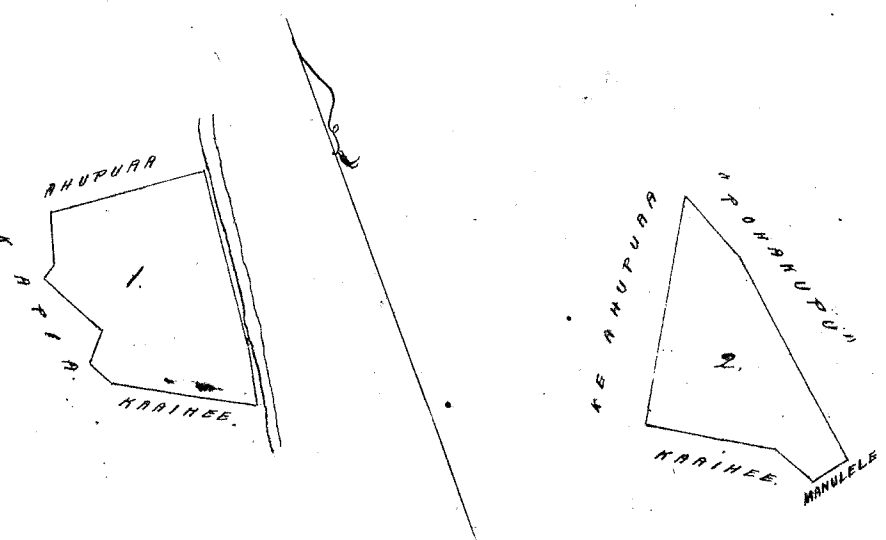

Scale 10 Chains to inch.

Helu 6245 Kalaokokoi (no Keaka)

Ua hoi mai oia no kona wahi pahale i Makalahalo ma Lahaina ma ka Mokupuni o Maui; no ka mea, ua loa ia ia keia pahale no Keaka ma mai i ka manawa i make ai o Liliha i ka Makahiki 1839, a ua noho keakea oleia a hiki i keia manawa.

Oia ka maikai e hoohe me no Keaka; he kuleana hoi kona malalo iho o ke Ano Aloha. Ima e uku mai oia i ko ke Aupuni hapaha; alaila, ua kiihono ia ia ka palapala Ili Aloha.

Pono mai ia ia ke uku no ka hoohehoholo a me ka hooheholo ana i ka olelo. Penei:

- W. Lee No ka rumi a me ke pahi ana i ka olelo ma ka Nupepa.
- G. M. Robertson No ke kope ana i ka olelo koina
- J. H. Smith No ka palapala kii
- J. Keirulaha No ka luna ana i ka la 16 o June 1853
- No ke kope ana i ma olelo a ma piko
- No ke ana ana i ka la 8 o October 1852
- No ke kope ana
- No ka hooheholo ana i ka olelo i ka la 16 o June 1853.

\$ Ken.

Oia ma palena.

\$ 5 00

Anaia e A. F. Turner

Pahale ma Makalahalo, Lahaina Maui.

E hoomaka ana ma ke kiki Kama a e holo ana

Maui 50 1/2	Hikiina	142	paauhu ma ko Kapioli.
Maui 27 1/2	Komohana	113	" " ka Loko
Kama 56	Komohana	177	" " ko Keaka
Kama 44	Hikiina	127	" " ke kaha ana i ke kiki (mau) 18/100 Eka.

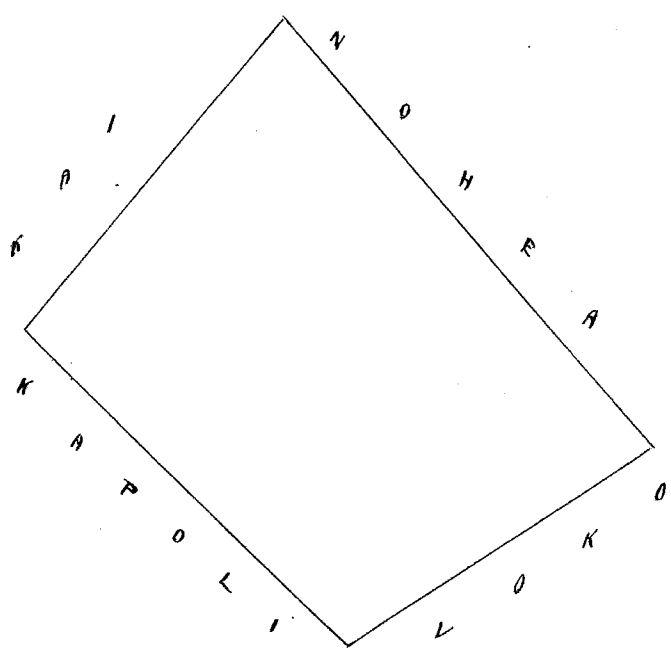

Helu 4747 Kama

Ua hoi mai oia no kona mau wahi Pahale ma Lilo a me ka Apana aina ma Kii i Honolulu ma Kona ma ka Mokupuni o Oahu; no ka mea, ua loa ia ia keia mau wahi no Kaaiaawaawa mai māmua aku o ka make ana o Kama i ka makahiki 1839, a ua noho keakea oleia a hiki i keia manawa.

Oia ka maikai e hoohe me no Kama; he kuleana hoi kona malalo iho o ke Ano Aloha. Ima e uku mai oia i ko ke Aupuni hapaha; alaila, ua kiihono ia ia ka Palapala Ili Aloha.

Pono mai ia ia ke uku no ka hoohehoholo a me ka hooheholo ana i ka olelo; Penei

- No ka rumi a me ke pahi ana i ka olelo ma ka Nupepa
- No ke kope ana i ka olelo koina

W. Lee
G. M. Robertson
J. H. Smith
J. Kikauatavao

No ka palapala kii
No ka hana ana i ka la 4 o Novemaba 1851.
No ke kope ana i na olelo a na hoike 1 Aoao.
No ke hana ana i ka la 23 o Mei 1853.
No ke kope ana
No ka hoohele ana i ka olelo i ka la 26 o Iune 1853.

Eia ma palena. Anania e S. P. Kalama.

Aina ma Koinuu, Honolulu, Oahu.

Spana 1. Pahale ma Deleo. E hoomaka ma ke kiki Komohana maha o ka pa o Kaapuni, ke kiki Kama o keia pahale a pili ana me ke Alanui Alii a hele ana i Ewa, - A e holo Maau 62' Kikina 276 Pautu a pili ana me ka pahale o Kaapuni a hiki i ke kiki Kikina mauka o keia pa, Maia Maau 29' Kom. 196 Pautu ma ka aao mauka a pili ana me ke ke Komohiki a hiki i ke kiki Maau o keia pahale. Maia Kama 62' Kom. 262 Pautu ma ka aao ma Ewa a hiki i ke Alanui Alii, - Maia Kama 26' Kiki, 196 Pautu ma ka lili mauka o ke Alanui Alii a hiki i ka hoomaka ana.
Eia ka Ii 53/100 Eka.

Spana 2. I Loi. E hoomaka ma ke kiki Komohana maha o ka aina o ke Aupuni ma "Aala", A e holo Maau 40' Kikina 103 Pautu, a Maau 57' Kikina 190 Pautu ma ka auwai i waena o keia me ka aina o ke Aupuni a hiki i ke Komohiki, Maia Maau 44' 30' Kom. 148 Pautu a pili ana me ka aina o ke Komohiki a hiki i ke palena o ka aina o Kukui, Maia Kama 50' Kom. 187 Pautu a pili ana me ke Kukui a me Keonokapu, - a Maau 45' Kom. 48' Pautu, a Kama 55' 30' Kom. 62 Pautu a pili ana me Keonokapu a hiki i ka pohaku, - Maia Kama 51' Kom. 41 Pautu, kiki Komoh. o keia a Kama 38' 30' Kikina 194 Pautu a pili ana me Komohiki a me Kama a hiki i Kama me Komohiki, Maia neenee kupono iuka 8 Pautu, heke, a neenee kupono Lima Maau 6 Pautu pili me Komohiki a hiki i ka hoomaka ana. Eia ka Ii 557 Anana.

Mei 23, 1853.

S. P. Kalama
Aina Aina

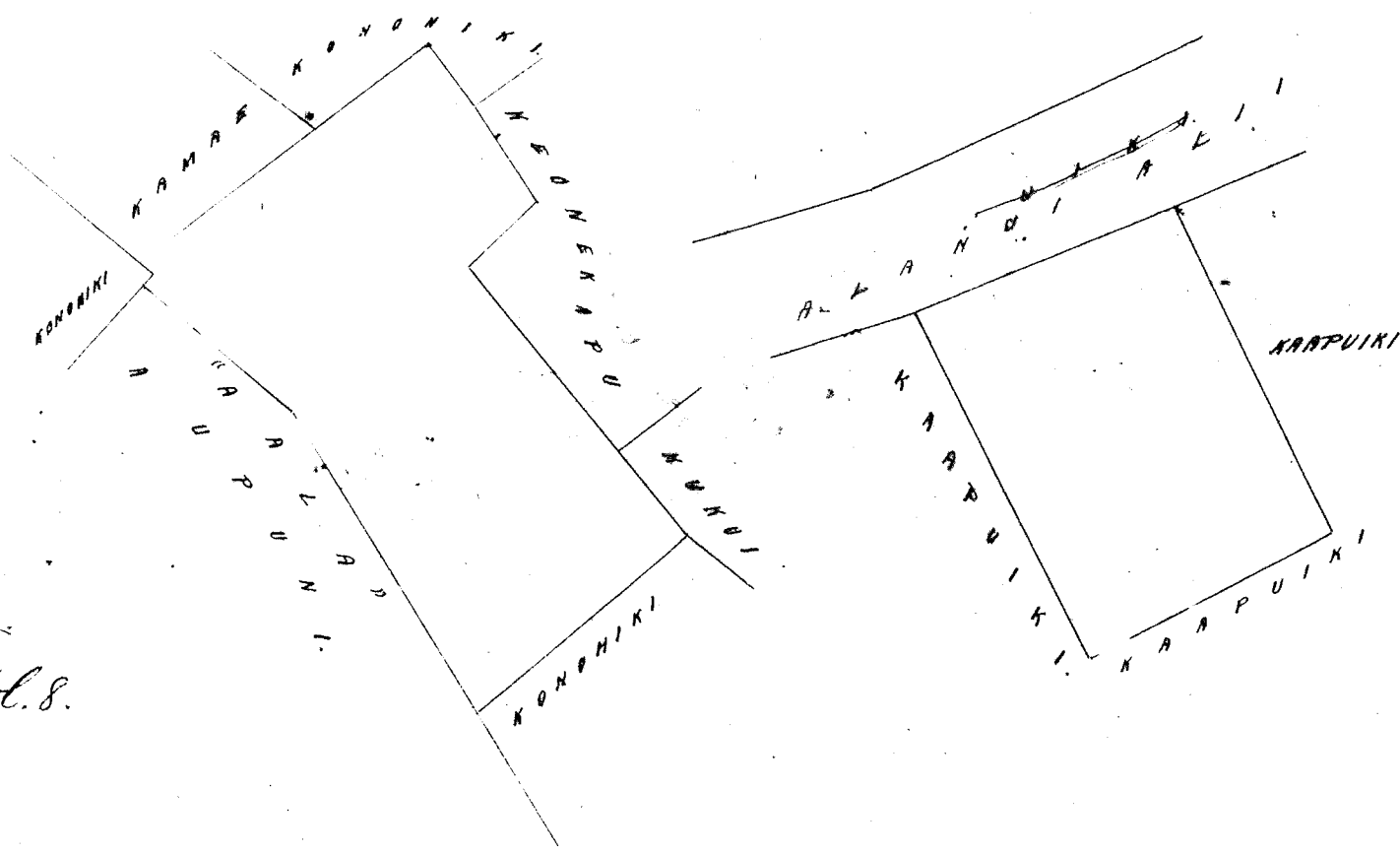

Nana Aoao 679 Vol. 8.

Hele 3176 George Kailaa }
" 10605 Iona Piikoi } no Kamakee.

Ua hoi mai kama no ka pahale o Kamakee ma Honolulu nei ma Kona, ma ka Moku o Oahu, no ka mea, a loa ia ia keia wahi no Kaaukai mai kona kaunani, a ua loa hoi keia wahi ia Kamakee i ka makahiki 1842, a ua loa hoi ia Kaaukai no ke Alii mai i ka makahiki 1832, a ua oho no o Kaaukai ma keia pa a hiki i kona manawa i hele ai i Hawaii, kaoha oia i keia wahi no Kamakee, a me Kamakee ia pa a hiki i keia la, a o G. Kailaa ka mea malama a oho hoi amatolu mai o Kamakee a keia nei no malala malala mai o Kamakee, a pela no ka moku uua o ma oha malalo o keia pa, aia laka.

Ua fau malalo o Kamakee ka mea nona ka fa'avae mai a Kaaukai, a malalo no hoi i noho ai o Ihu ka
 mahuakame o Kamakee, malalo ma masopopo loa, no Kamakee kela fa'a, a no ka mea hoi, aole no i mea i
 hoi mai i ke kaucha ana a Kaaukai i keia fa'avae Kamakee. Aka, ke hua mai nei ma hooitina o Kamakee
 kaaloa, kekahi mea i noho pu me Kaaukai, a ua hoi mai he kuleana nona ma keia fa'a; aka, i ka nana ana i
 ma ole hoi, aole hua kuleana masopopo, aole ukaha kahi i'loa mai ai, aole no hoi mea nana, i hoi mai i
 ka haawi'ile'loa i o ka wahi o keia fa'avae no Kamakee, aole no hoi i'loa kekahi olelo kaucha a Kaaukai ka
 mea nana, i'loa, ma keia wahi mai ke Lii mai; Aka, ua noho pu wale iho no o Kamakee ma keia wahi
 malalo aku o Kaaukai ka mea nona kahi ma ke ano o hua a hooaloa hoi i'like me ke ano mau o keia kahi,
 a ua kukulu no i hui nona, malalo no mau o Kaaukai, a ua kokua no i ka fa'avae i keia wahi malalo no o Kaaukai,
 a ua noho pukele wale no a haalele iho no o Kamakee a hoi loa aku i Maui, a he noho nei no o I. Kaitan
 ma na opua pona o Kamakee ma keia fa'a a hiki i keia manawa. Aka, ua masopopo ma keia hooaloa
 aole he kuleana fa'a Kamakee ma keia wahi, aole no hoi he kuleana o ma mea e ai a fa'u loa ma keia fa'a;
 aka, no Kaaukai wale no a i Kamakee kona hooitina, ma keia fa'a.

Oia ka mahuakame hooaloa no Kamakee; he kuleana hoi kona malalo iho o ke Awa Aloha, Ima
 e ukua mai oia i ke keia oia i ka fa'a, a ka, ua hooaloa ia ia ka Palapala, Ima Aloha.
 Pona nae ia ia ke ukua no ka hooaloa o ma keia hooaloa ana i ke olelo. Ima.

H. Lee
 G. M. Robertson
 J. H. Smith
 J. Kikaulana

No ka nuni a me ke fa'avae ana i ke olelo ma ka Mapepa
 No ka kope ana i ke olelo koina
 No ka palapala kii
 No ka hua ana i ka fa'a 1 o Iulai 1851
 No ke kope ana i ma olelo hoi 1 Awa
 No ke ana ana i ka fa'a 2 o Aperila 1853
 No ke kope ana
 No ka hooaloa ana i ke olelo i ka fa'a 28 o Iune 1853.

\$ Kent.
 \$ 8.00

Iu ma palena. Amia o I. Kalamia.

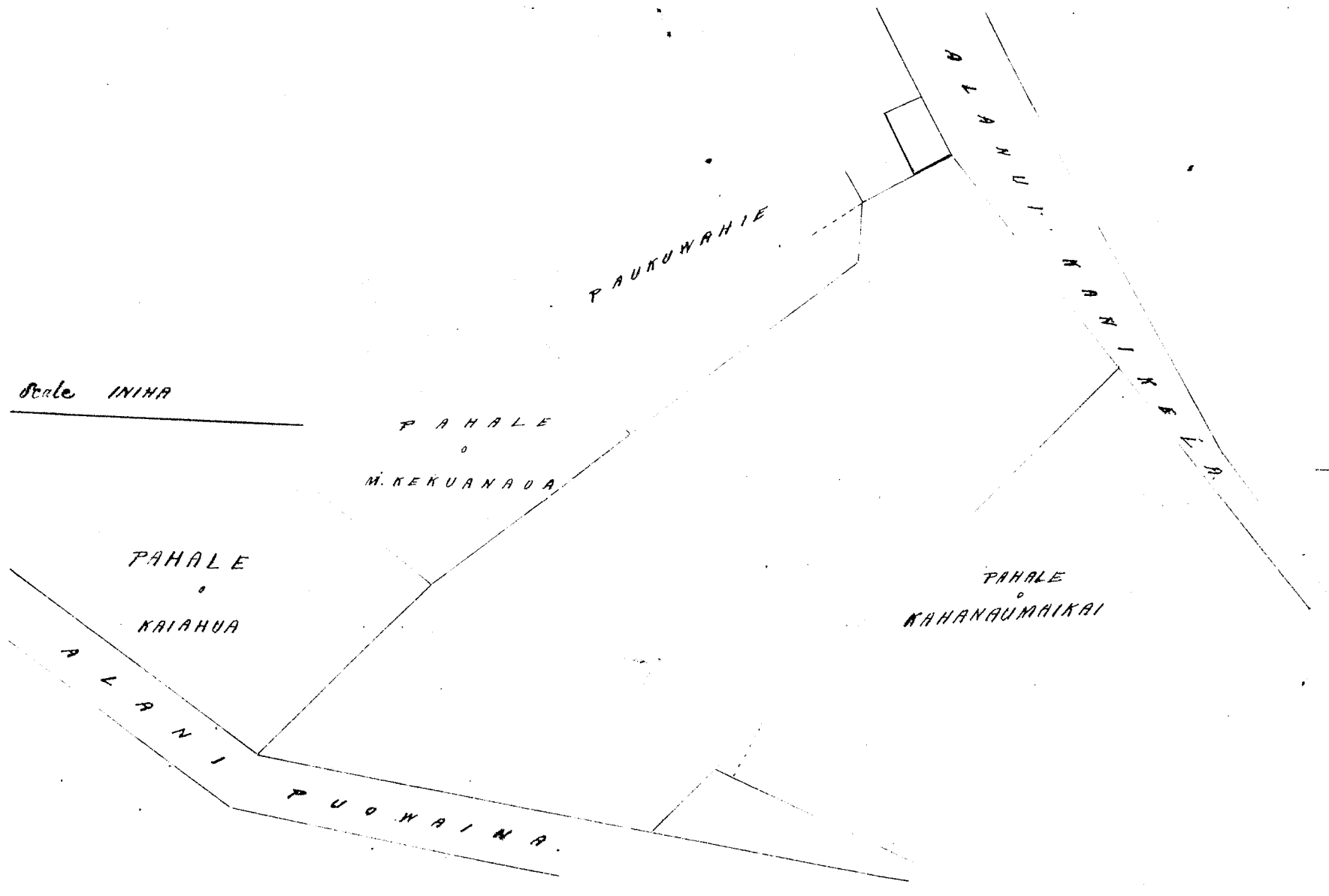

Iuhale ma Honolulu, Oahu. O hoomaka ma ke kahi Akau o keia pakahi, a e holo i kama 47° 30' Hikina
 465 Paku fiali ana me ka fa'a o Kahanauaikai a me kahi waiho wale i hiki i ke Alamui Prouina; Alaila
 Hema 9° Kom. 285 Paku ma ke kahi Akau oia Alamui a hiki i ke kahi Hema o keia e fiali ana me ka fa'a o
 Kaiahua, Alaila Akau 46° Kom. 173 Paku fiali ana me ka fa'a o Kaiahua, Alaila Akau 40° Kom. 382 Paku, a
 56 Paku fiali ana me ka fa'a o M. Kekuanaoa a me Pauowahie, Alaila Akau 30° 30' Kom.
 67 Paku me ka fa'a o Kanai (Reynolds) a hiki i ke Alamui Kanikela kahiko, Alaila Akau 47° 30' Hikina 191
 Paku fiali ana ma ke Alamui Kanikela kahiko a hiki i ke hoomaka ana.
 Oia ka Ii : 1 Eka 212 Anana.

Wa koi mai oia no kona wahi: Aina ma Kaalaa Luma i Honolulu Aina ma Luma, ma ka Motu o Oahu; no ka mea, ua loa ia ia keia wahi no Kupa mai kona kane i ka makahiki 1848, a ua noho o Kupa malaila a hiki i ka manawa maunua iho o ka make ana o Kupa, ma ka 1848, a o Laakiwa iho ke kane a Kamihana, a ma Laakiwa no i hele i ma ka hana o ke Honolulu a hiki i ka makahiki 1848, make iho la o Laakiwa, a ili kahi a pau loa ia Kamihana. Ika, ua koi mai o Kamihana i kela wahi Apana aina a pau nona, aka, ua hui mai o Kaka ka Luma Honolulu aua hui pu mai no koi o B. Namakaha ke Honolulu i keia huihana me ka olelo 'Aole ou keakea i fono loi hookahi e maikai nei e Kaiwi kana keiki, aka, o ma wahi e ae ana e koi nei oia kiau keakea no ka mea ua hookahi mai au e N. Hooliliama ke Honolulu Luma aua ma kela mau loi no ka hookahelahele aina, I ka wana ana i ma olelo a ma huike a me ka wana i ka aina, aole i maikai e Kamihana keia mau loi a pau, aia no i ka hana o ke Honolulu mai ka hookahi ana o ke Honolulu a hiki i keia ka. Naitale, ua maopopo aole ke huihana maopopo o Kamihana ma na Loi e huike, a e hui ia mau loi e huike no B. Namakaha ke Honolulu, a ke hookahi nei ma ka mau Kamihana, i hookahi Loi e huike me ke ana a S. P. Kalama i hookahi malalo nei.

Oia ka makou e hookahi nei no Kamihana a ia Kaiwi paanakeiki, ke huihana koi kona malalo iho o ke Aunoi Alodio. I wae ikuh mai oia i ke ke Aunoi hapaha; alaila, ua kuppno ia ia ka Palapala Pila Alodio.

Pono mau ia ia ke uku no ka hookahelahele a me ka hookahelahele ana i ka olelo. I nei, -

1/2 Kev.

W. Lee
G. M. Robertson
J. H. Smith
J. Kekaulaha

No ka rumi a me ke fua ana i ka olelo ma ka Muepa
No ke kupa ana i ka olelo koina
No ka palapala hii
No ka hana ana i ka la 22 o Aperila 1851 a me Sepatemaba 9, 1851.
No ke kupa ana i ma olelo a ma huike. 3 kupa Aunoi
No ke ana ana i ka la 30 o Maraki 1853.
No ke kupa ana
No ka hookahelahele ana i ka olelo i ka la 28 o Iune 1853.

7.00

Oia ma palapala Aina e S. P. Kalama.

Aina ma Kaalaa Luma ma Honolulu Aina ma Luma, Oahu.
Loi E hoomaka mai ke kahi Honolulu (Makaia ma ka hookahi palapala malalo aua o (Kuauna) o keia Loi ke kahi hema o kahi Loi Aunoi, a e holo Aunoi 38' (Kikina) 254' Puntun e hui ana me ka aina o Kaunuehameha a me ka Niu a hiki i ke kahi Aunoi o keia e hui ana me ka aina o ke Honolulu. Alaila Aunoi 48' 30" (Kikina) 236' Puntun e hui ana me ke Honolulu a hiki i ke kahi Kikina o keia Loi, a Aunoi 46' 15" (Koin) 287' Puntun e hui ana me Honolulu a hiki i ke kahi Aunoi. Alaila hui a holo palapala ikaia e hui ana me ka Loi o M. Kekaulaha a me ke ke Aunoi a hiki i kahi i hoomakaia. Oia ka Ali 720 Aunoi.

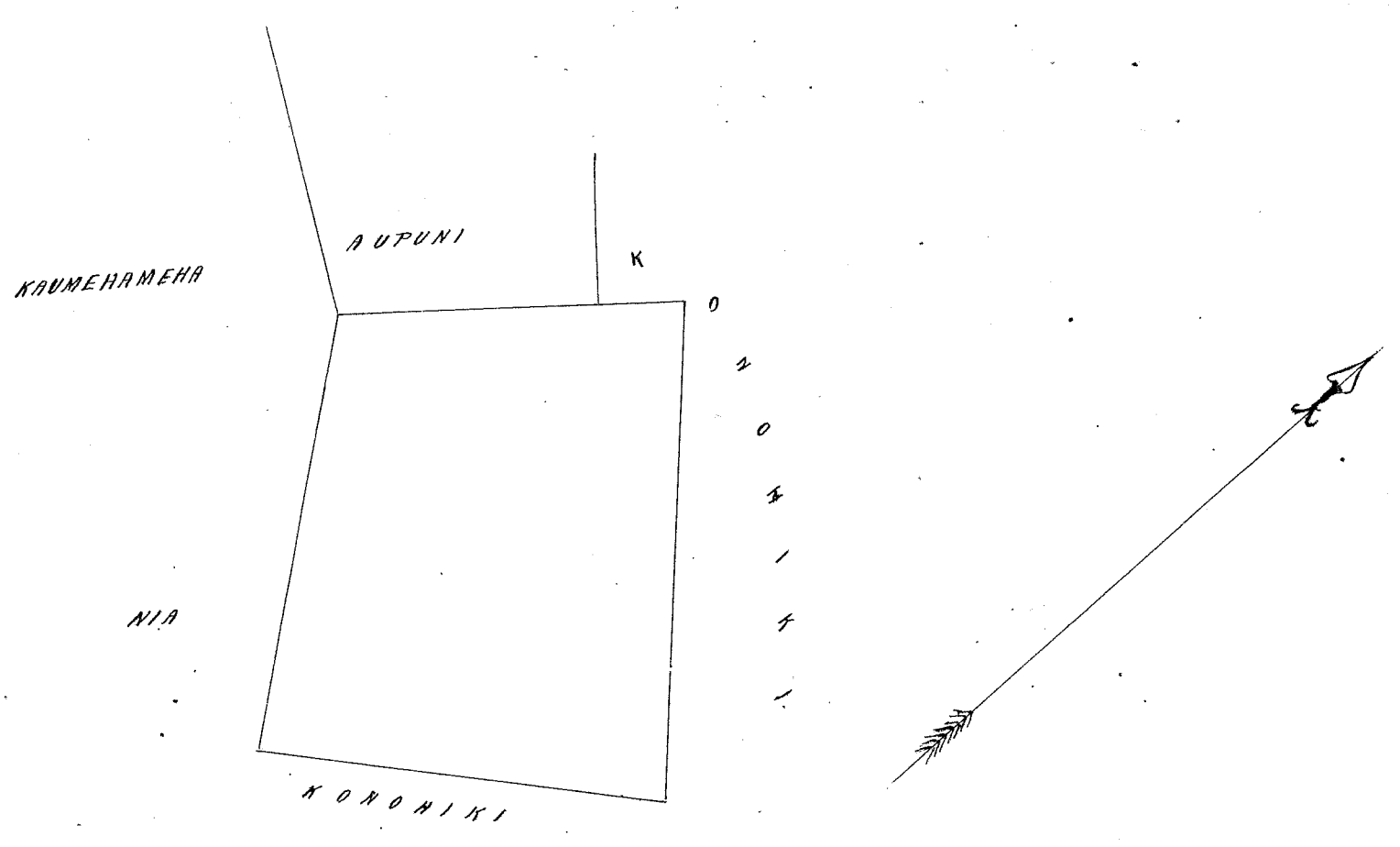

INIA SCALE

Heleu 2 FL. Kamoku

Ua hoi mai oia i kona aina ma Hauhaikai Iki no Honolulu, Oahu, i like me na Kanawai o ka Makahiki 1851 no na Aina Papu, no ka mea, ua loa ia ia keia aina no Kamoku ka Luna Honohiki i ka wa e ola ana o Kaniou mamua aku o ka makahiki 1839, a ua noho oluolu oia a hiki i keia manawa aole mea keakea

Oia ka makou e hooke nei no Kamoku, he kuleana hoi kona malalo iho o ke ano Alodi, ina e ukou mai oia i ke ke Aupuni hapaha, alaila kupono iou ia ka palapala eila Nui Alodi.

Nono nae ia ia ke ukou no ka hookelelele a me ka hookelelele ana i ka olelo Feni.

- W. L. L.
- G. M. Robertson
- J. H. Smith
- J. Kekaulahas

- No ka aumi a me ke spai ana i ka olelo ma ka Kupepa.
- No ke kope ana i ka olelo keina
- No ka palapala kii
- No ka hana ana i ka 16 o Dekemaba 1851.
- No ke kope ana i ma olelo hoi ke 1/2 aao.
- No ke ana ana 14 Apriila 1852 - Ukuia ke ana \$6.00
- No ke kope ana
- No ka hookelelele ana i ka olelo 30. Iune 1853.

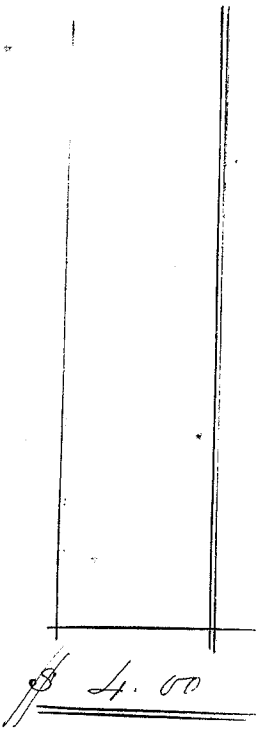

Eia ma palena

Anaia e S. P. Kalama.

Aina ma Hauhaikai, Honolulu, Oahu.

5 Loi me ka huahala. E hoomaka ma ke kiki Komohana o keia aina, me kiki Akaui, ka aina o Kaanaana e pili ana me ka aina o I. Kaa "Kahawali" keia. A e holo Akaui 53°30' Hikiina 1 2/100 kaulaha e pili ana me Kahawali a hiki i ka aina o ke Aupuni. Alaila Akaui 62°30' Hikiina 1 19/100 kaulaha ma ka aina o ke Aupuni a hiki i ke kape, - alaila Kema 36°30' Hikiina 2 66/100 kaulaha, a me Kema 70° Kom: 43 Panku, a me Kema 12° Hikiina 39 Panku; a me Kema 53 Hikiina 24 Panku; a me Kema 38 Kom: 28 Panku e pili ana me ka aina o Kape a hiki i ka p. auwai kii me Keonekapu; alaila Kema 73°30' Kom: (ma 61 Panku e pili ana me ka auwai - ma 76 Panku Keone L. Akaui 6 Panku i kaui anaku auwai ma 124 Panku pili auwai) 1 5/100 kaulaha ma ka auwai ka palena me Keonekapu; a me Akaui 51 Kom: 17 6/100 kaulaha e pili ana me Keonekapu a hiki i ke Kaanaana; alaila Akaui 35 Hiki: 40 Panku; a me Akaui 35 Hiki: 40 Panku; a me Akaui 46° Kom: 1 2/100 kaulaha me ke Kaanaana a hiki i kaui i hoomaka i ke ana ana.

Eia kea Iki 8 1/2 Anana

S. P. Kalama.

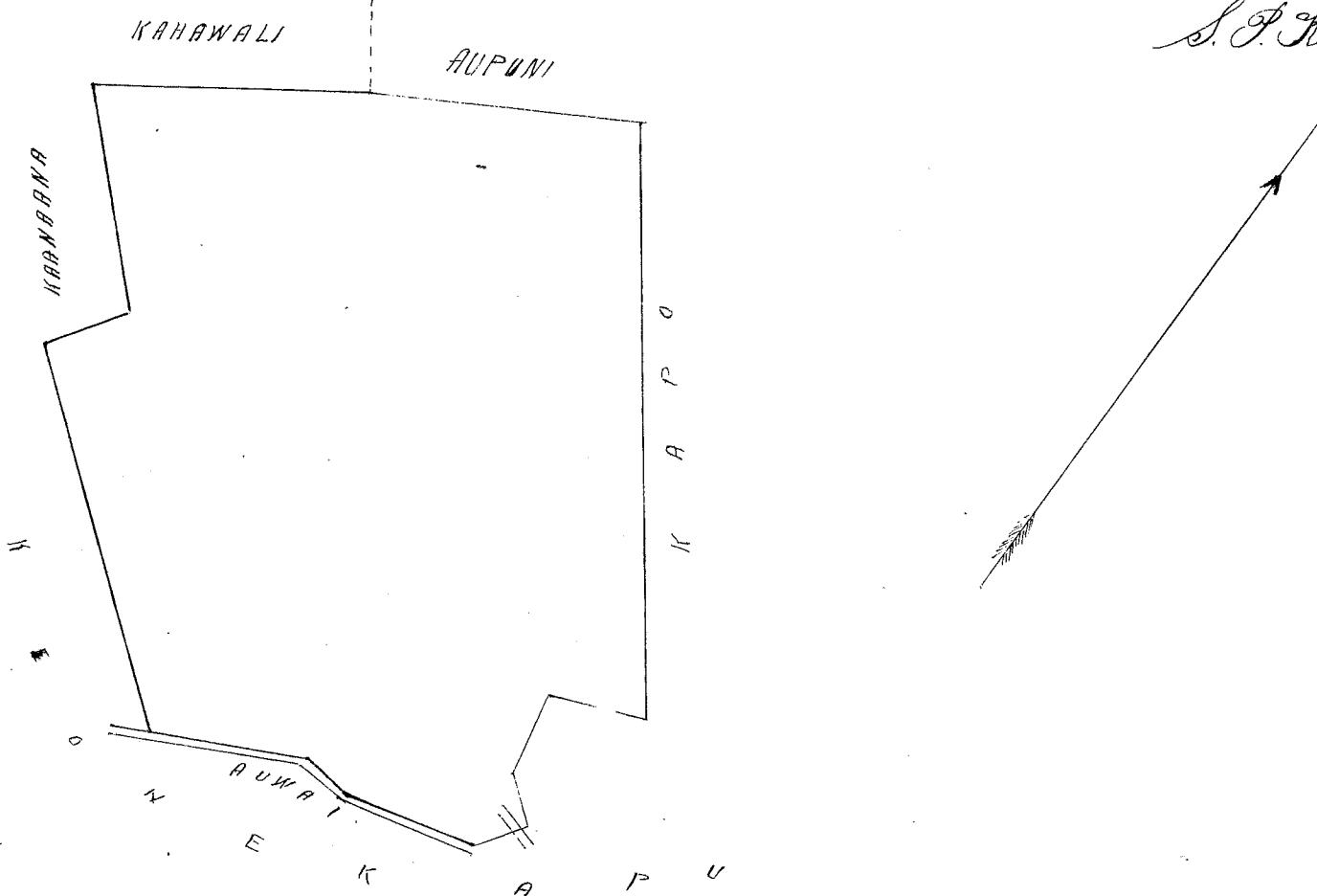

Heleu 4 FL. Kamau

Ua hoi mai ia i kona aina ma Kaale Iki no Honolulu Oahu i like me na Kanawai o ka M. H. 1851 no na Aina Papu, no ka mea, ua loa ia ia keia aina no M. Kekuanana mai i ka M. H. 1842 i ka wa o M. Kekaulahi ke Kuhina Nui, a ua noho oluolu oia a hiki i keia manawa aole mea keakea.

Oia ka makou e hooke nei no Kama, he kuleana hoi kona malalo iho o ke Amo Alodio, ina e ukou mai oia i ke ke Aupuni hapaha, alaila kupaia ia ia ka Palapala Sila Kii Alodio

Pono mai ia ia ke ukou no ka hookelele a me ka hoohele ana i ka olelo Penei-

No ka nuni a me ke pui ana i ka olelo ma ka Mupepa.

No ke kope ana i ka olelo koina

No ka palapala kii

W. L. Lee

G. M. Robertson

St. Smith

J. Kikaulaha

No ka hana ana i ka la 16, o Dekemaba 1851

No ke kope ana i ka olelo hookelele 1/3 avar.

No ke ana ana 22 Aperila 1852. Ukuia ke ana \$4.00

No ke kope ana

No ka hoohele ana i ka olelo 30. June 1853.

\$ 4.00

Eia ma palena.

Maia i S. P. Kalamia.

Kuleana o Kama ma Kaale, Honolulu, Oahu.

L. Poi. E hoohele ma ke kii Komohana Akaa o keia kuleana, (4 Puka i ke kii Kikina ma keia o ka pua o Johnston) a e hoohele Kama 42° Kom, 17¹/₁₀₀ kaub. ma ke pua o Johnston a hiki i ke Maui, - alaila Kama 45° Niki. 2⁷/₁₀₀ kaub. ma ke Maui a hiki i ke Malikini, - alaila Akaa 83° 30' Niki. 21 Puka, a me Akaa 31° 30' Niki. 1⁴/₁₀₀ kaub. a me Kama 64° 15' Niki. 32 Puka hiki i ke auwai, a me Akaa 32° 30' Niki. 25 Puka ma ke Malikini a hiki i ke kii Kikina Akaa o keia kuleana ma ka lina Akaa o keia hoi puka + 4 Puka ke akeas, - alaila keia hoi i keia i hoohele i ma ka mimi puka ma ka lina maikai o ke Alanui a pua keia kuleana.

Malalo oia Kuleana Kapaia Oka

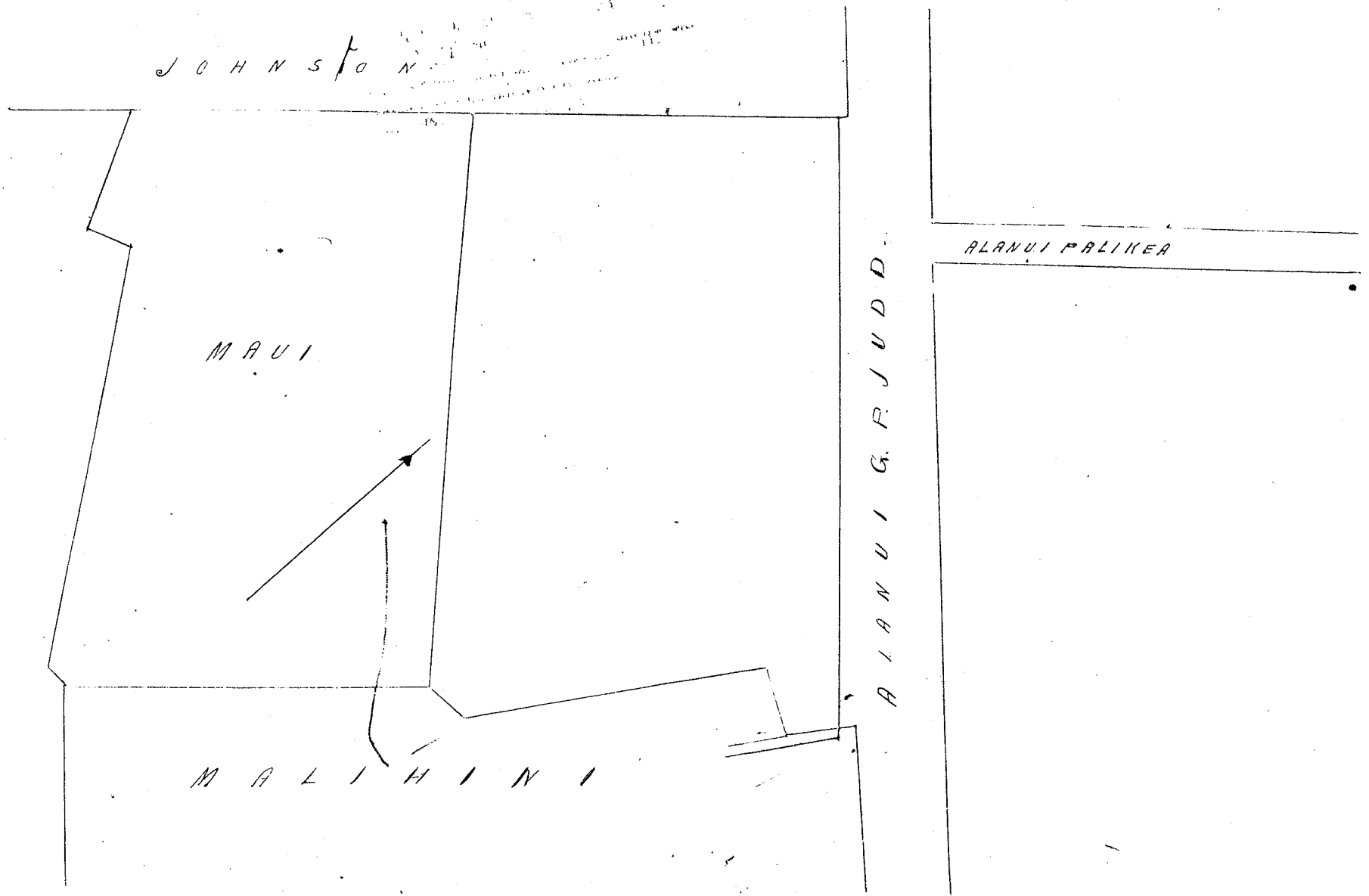

Helu 12 FL. Kahoowahaloa.

Ua koi mai oia i kona aina ma Kuwili Ili no Honolulu, Oahu e like me ma Kanawai o ka M. H. 1851. ma ma Aina Pupu, no ka mea, ua hana ia ia keia aina no Maumau kona kupaia i ka wa e moho Kiamama a ma o S. A. Kuvakini ma ka M. H. 1831, a ua moho oluolu oia a hiki i keia onawau, aole mea keakea.

Oia ka makou e hooke nei no Kahoowahaloa, he kuleana hoi kona malalo iho o ke Amo Alodio, ina e ukou mai oia i ke ke Aupuni hapaha, alaila kupaia ia ia ka Palapala Sila Kii Alodio.

Pono mai ia ia ke ukou no ka hookelele a me ka hoohele ana i ka olelo Penei-

No ka nuni a me ke pui ana i ka olelo ma ka Mupepa.

No ke kope ana i ka olelo koina

No ka palapala kii

No ka hana ana i ka la 22, o Dekemaba 1851.

W. L. Lee
 G. M. Robertson
 J. Kekaulaha
 S. H. Smith
 Eia ma palena
 Anania e S. P. Kalama

No ke kope ana i ma olelo huike 1/2 arao.
 No ke ana ana i ka la 13, o Aperila 1852
 No ke kope ana.
 No ka hooholo ana i ka olelo 30, o Iune 1853.

\$	3-

Aina ma Kuwili, Honolulu, Oahu.

Pahale a me 1 Loi. E hoomaka ma ke kihi Hikina o keia Kuleana, e pili ana me ke kihi Nema o keia Pahale o Loi, a me ke ala ololi, a e holo i ka Nema 44° Kom: 1 3/100 kaub. me ke ala ololi e mahela ana i ka punawai a hiki i ka lihi maika o keia auwai i Koiuu, alaila Akaun 23° Kom: 90 Pautu me ke ala auwai, a me Nema 78° Kom: 1 7/100 kaub. a me Akaun 38° 30' Kom: 1 9/100 kaub. a me Akaun 53° Kom: 50 Pautu, a me Akaun 37° 30' Nite: 64 Pautu, a me Akaun 1° 30' Kom: 85 Pautu ma ke ke Aupuni a hiki i ke Loi, - Alaila Akaun 42° Niteina, 52 Pautu, a me Nema 59° Nite: 1 7/100 kaub. a me Nema 41° Nite: 1 6/100 kaub. a me Akaun 57° 15' Nite: 1 4/100 kaub. e pili ana me huana o Loi a e mohu ana keia i ka auwai a hiki i ka kihi i hoomaka i.

Ma ke o keia Aina 7/8 Eka.

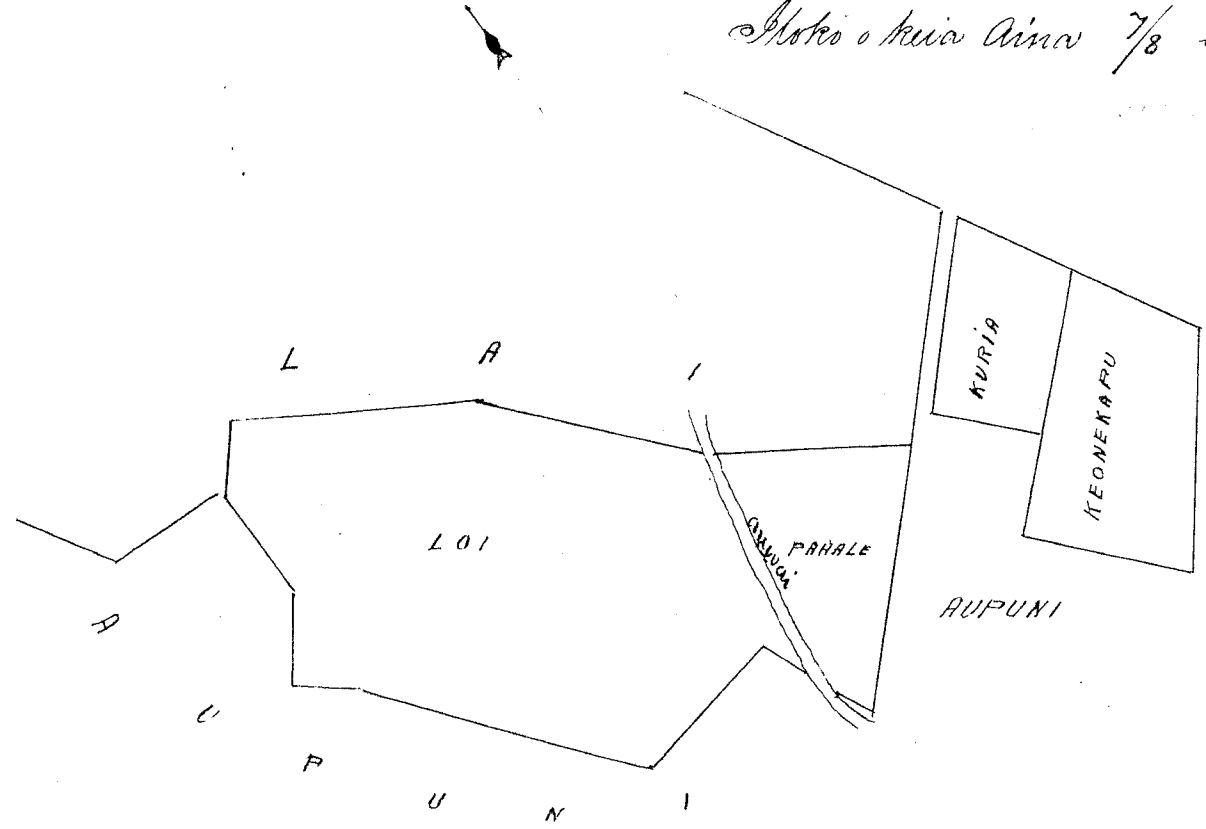

Hele 23 FL. Moelino.

Ua koi mai oia ma kona apuna aina ma Kuanawai, Ili o Honolulu, Oahu e like me ma Kuanawai o keia M. H. 1851, no ka mea, ua loa ia ia keia apuna aina ma Kanikou mai i ka M. H. 1840 i ka waa No. Kekaulaha keia Kuanawai, a ua mohu olelo oia a hiki i keia manawa, aole mea keakea.

Oia ka maku e hooke me o Moelino, ke kuleana hui kama malalo o ke ala Alodio, ma e wai mai oia i ke ke Aupuni hapaha, alaila ua kope oia i ka Palapala Ili o Alodio.

Imo mai ia ia keia ma oia o keia hooke oia o keia hooke oia o keia olelo Penei:

W. L. Lee
 G. M. Robertson
 S. H. Smith
 J. Kekaulaha

No ke kope ana i ma olelo huike 1/2 arao.
 No ke ana ana i ka la 2, o Dekemaba 1852
 No ke kope ana.
 No ka hooholo ana i ka olelo, 30, o Iune 1853.

Eia ma palena

Anania e S. P. Kalama.

\$	3.00

Aina ma keia Ili o Kuanawai, Honolulu, Oahu.

1 Loi. E hoomaka ma ke kihi Komoana o keia Ili, ke kihi Akaun o keia Aina o Kuanawai, ma keia Moelino o "Honolulu" me "Kapalama". A e holo Akaun 41° 45' Nite: 1 4/100 kaub. ma Kapalama a hiki i ka pohaku i ka kama ke A, - Alaila ma ke lihi keia pali paakea, Akaun 64° 3/4 Nite: 25 Pautu, a me Nema 35° Nite: 90 Pautu, a me Nema 53° 10' Nite: 70 Pautu, a me Nema 31° Nite: 69 Pautu me ke kihi o Kuanawai, a me Nema 20° Nite: 54 Pautu ma ke Kuleana oia a hiki i ka hua palapala i keia hua hua ma keia pali paakea e pili ana me ke Kuanawai, - Alaila Nema 49° 30' Kom: 88 Pautu me ke Ili o Kuanawai a hiki i keia Ili oia ma Pahala, alaila huli a holo palele ma huana iwaena o keia oia

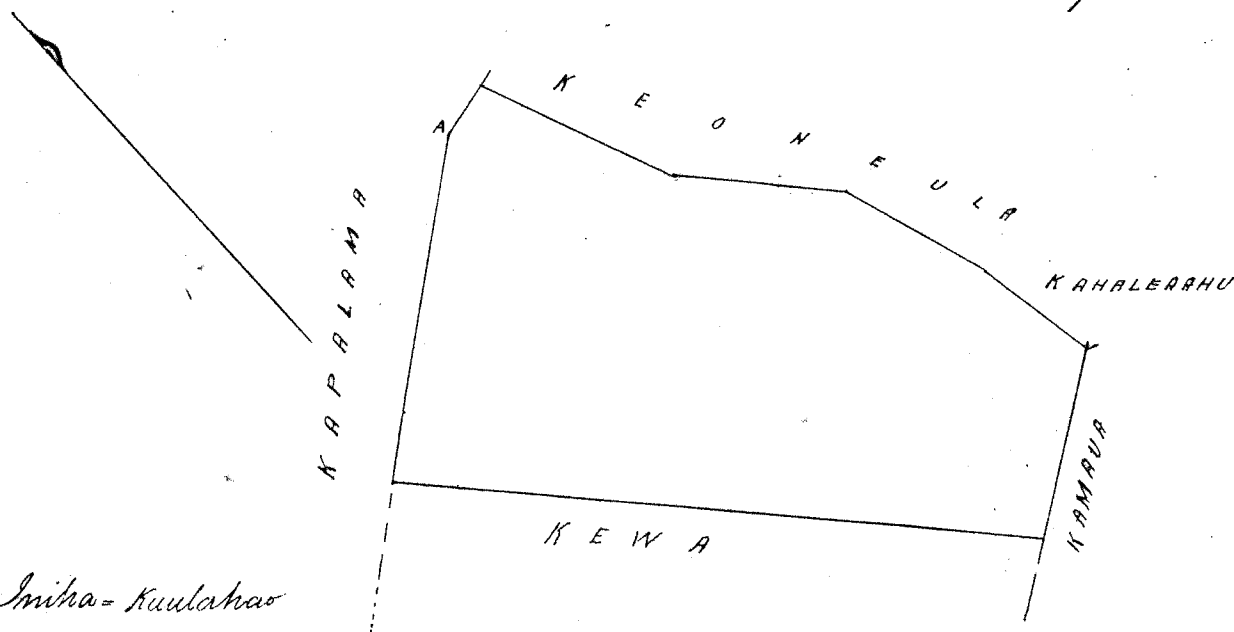

1/4 Inika - Kaulahao

Heleu 3427 B. Kapu

Ua hoi mai oia no kona aima mai Kalii, i Honolulu, Oahu, no ka mea ua loa ia ia hua Apana aima no Kaunamakea mai, mamua atu o ka holo ana mai o Liholiho mai Oahu nei, a ua loa hoi ia Kaunamakea no Pih mai, a ua noho keakea ole ia a hiki i keia manawa.

Oia ka makou i hooko nei no Kapu, he kuleana hoi kona malalo iho o ke ano Alodio, inoa e ukou mai ia i ke ka Aupuni hapaaha, alaia, ua kupaia ia ia ka Palapala Sila Nui Alodio.

Pono ia ia ke ukou mai no ka hookohole a me ka hookohole ana i ke olelo. Puni,

W. L. Lee
G. M. Robertson
J. H. Smith

No ka ukou a me ka pua ana i ke olelo ma ka Aupuni
No ke kope ana i na olelo koia.
No ka palapala kei.
No ka hana ana i ke ka 22 October 1852.
No ke kope ana i na olelo hooko pua.
No ke ana ana i ke ka 30, o June 1853
No ke kope ana.
No ka hookohole ana i ke olelo 2 Iulai 1853

J. Kaulahao

Eia ma palena

Maia e S. P. Kalamo.

Apana 1. Aima mai Kalii, Honolulu, kona Oahu.

2. Loa. E hoomaka ma ke hiki Honolulu o keia aima, e pili ana me ka aima o ke Honolulu, a holo Kema 39° Nihina 145 Pautu, ma ke holo Honolulu a hiki i ke Liholiho. Alaia Apana 51° Nihina 84 Pautu, a Kema 42° Nihina 37 Pautu, a Apana 36° Nihina 79 Pautu e pili ana me ke Liholiho a hiki i ke f. Kapena, Alaia Apana 44° Kom: 147 Pautu e pili ana me f. Kapena i hiki i ke auwai, - Alaia Kema 57° Kom: 151 Pautu iho pihole i keia a hiki i ke hoomaka ana. Eia ka ili 285 Apana.

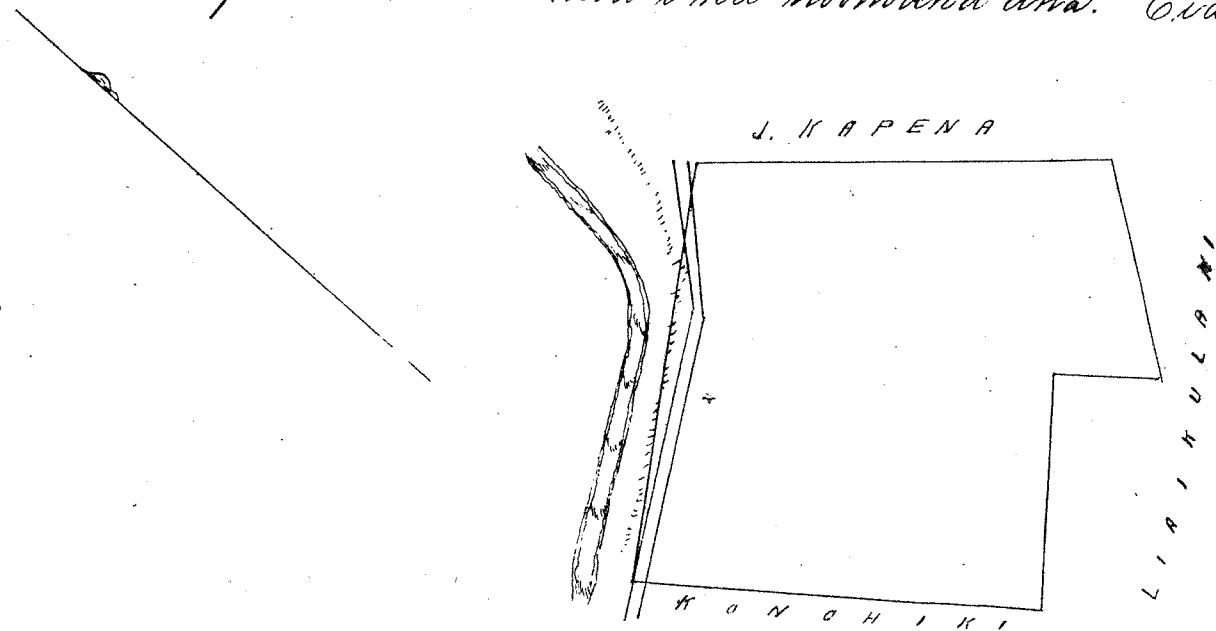

Heleu 3427 B. Kapu (no Hana Kawa)

Ua hoi mai o Kapu i ke Apana aima o Hana Kawa ma Kalii, Honolulu, Oahu, no ka mea, ua loa ia Hana Kawa no Kawehewa kona Makuakane ma ke kaouha i kona wa i mate ai i ke ka M. H. 1845, a ua loa hoi ia Kawehewa no Pih mai i ke ka M. H. 1832, a ua noho keakea ole ia a hiki i keia manawa.

Oia ka makou i hooko nei no Hana Kawa, he kuleana hoi kona malalo iho o ke

ano Uledi, ina e uku mai oia i ke ke Aupuni hapaaha, alaila kupaia ia ia ke Palapala Sila Nui Alodio.
 Pono ia ia ke uku mai no kea hookeohole, a me kea hookeohole ana i kea olele Tenui.

N. L. Lee
 G. M. Robertson
 J. H. Smith
 J. K. Anderson

No kea nuni a me ke paia ana i kea olele ma kea Kupaia.
 No ke kupa ana i ma olele kupaia.
 No kea palapala kupaia.
 No kea hawa ana i kea la 22, o October 1852.
 No ke kupa ana i ma olele hookeohole paia.
 No ke ana ana i kea la 30, o June, 1853.
 No ke kupa ana.
 No kea hookeohole ana i kea olele 2. Iulai 1853.

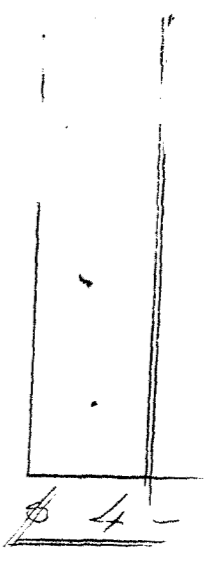

Cia na palapala.
 Ania e S. P. Kalama.

Apana 2. Aina ma Kalia, Honolulu, Hono, Oahu.

3. Loi. E hoomaka ana ke kupaia Konomohani o keia aina, e pili ana me kea aina o Pihaku, a me ke J. Kapena. A e holo Akau 71° 15' Nihina 92 Pautu, a me Akau 52° Nihina 178 Pautu e pili ana me kea aina o Pihaku, alaila Kema 37° Nihina 1 kuaulaha e moku ana i kea auwai, a holo ana ma kuauna o ke Konomohani, kupaia, a me Kema 55° Kom: 103 Pautu, kupaia, a me Kema 39° Nihina 132 Pautu, kupaia, a me Kema 49° Kom: 177 Pautu e pili ana me kea aina o ke Konomohani, a hiki i ke kupaia Kema o keia, alaila Akau 38° Kom: 210 Pautu, a me Akau 30° Kom: 103 Pautu e pili ana me kea aina o Mokuha, a me ke J. Kapena a hiki i kea hoomaka ana.

Cia kea Ii 742 Uwanā.

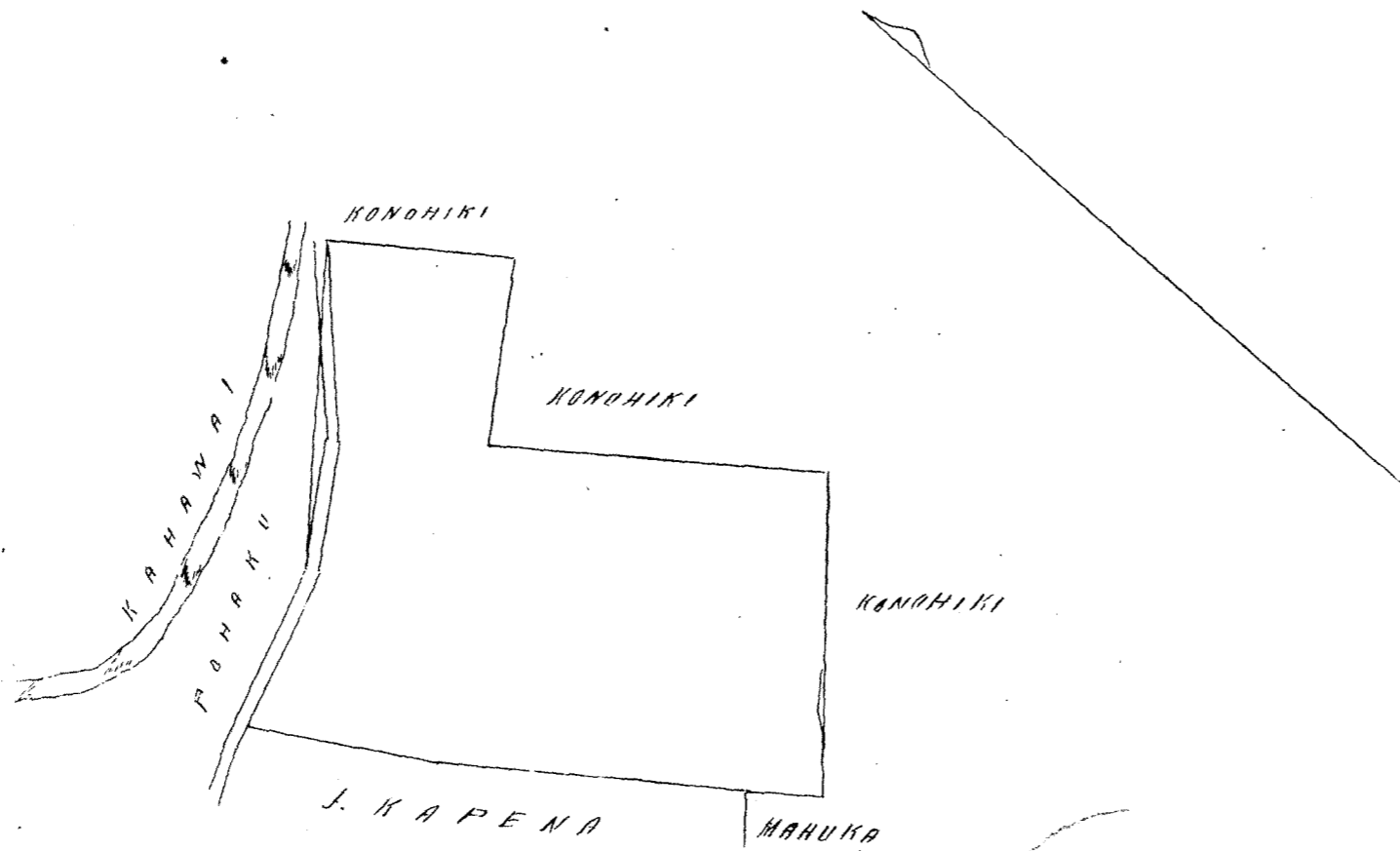

INHA SCALE

Hulu 30. Hookeohole. Kapuukolu From Page 56. Canceled P66 8/11/53

Ua hoomai ia ma kema mau Pahala ana Kupaia. Honolulu, Oahu. me kea mea, ma kupaia ia keia mau wahi ma kupaia mau makua mai i kea mea o Kamahehema 1. a ia mau ana ma makua mau makua kupaia ma Kupaia kea hawa kupaia, a me kea kupaia mai o Kupaia i kea Apana 1 ma mau a hiki i kea la 17, o Sepatemaba 1852 iho mai, me kea mea, ma hookeohole kupaia mai ia ma keia wahi, me kea mea, ma kupaia ia Kupaia keia wahi ma Kupaia mau kupaia ma kupaia ana o kea Kupaia o Kupaia mau mau a me kea holo ana o Kupaia i Beritania, a i kea la 17 o Sepatemaba ma hookeohole kupaia a kupaia ke Kupaia a me Kupaia. A o kea Apana 2. ma kupaia o kea Palapala i kupaia wahi i kea ia wahi ma kea mea, ma kupaia ia keia wahi ma Kupaia mau Kupaia i kea la 1847, a ma kupaia i kea Kupaia ma Kupaia mau mau a me kea wahi ana o Kupaia, a ma mau kupaia mau ana a hiki i keia mau mau, a me kea mau hookeohole ana ma holo ma Kupaia mau, a ma hookeohole i kea mau wahi, a ma kea hookeohole ana.

Cia kea makua e hookeohole ma Kupaia ke kupaia mau kupaia mau mau i kea (Uro Alodio, ina e uku mai oia i ke ke Aupuni hapaaha, alaila; kupaia ia ia ke Palapala Sila Nui Alodio.
 Pono ia ia ke uku mai no kea hookeohole a me kea hookeohole ana i kea olele Tenui.
 No kea nuni a me ke paia ana i kea olele ma kea Kupaia.
 No ke kupa ana i ma olele kupaia.

W. L. Lee
 G. M. Robertson
 J. H. Smith
 J. H. Kukulakao

No ka palapala hii.
 No ka hana ana ma ka la -
 No ke kope ana i na olelo hii
 No ke ana ana ma ka la 21, o Mii 1853.
 No ke kope ana
 No ka hoholo ana ma ka la 2, o Iulai 1853.

Eia ma palena.

Anaia e S. P. Kalama.

Kaw Pahale ma Kapunohu. Honolulu, Oahu.

Apana 1. Pahale. E hoomaka ma ka pahu i kuhikuhia e G. M. Robertson ma ke kai ana o Hinopu, ma ka lihi Ahau o ke Alanui Palaki ka inoa, ke hiki hikiina ma ka o keia pahale. Ueholo Nema 54^o Kom 67 1/2 kapuai ma ka lihi Ahau oia alanui, alaila Ahau 32^o 30' Kom: 54 1/2 kapuai, pili ana me ka pua o S. Kou. alaila Ahau 55^o 30' hikiina 71 1/2 kapuai i hiki i ka pahu i kuhikuhia e G. M. Robertson i hookeuwaale ai i hookeuwaale pahale (ma A. S. Turner i anaia mau ana) alaila Nema 28^o hikiina 53 1/2 kapuai i pili ana me ke Hinopu pahale i mahela ana i ka funawai a hiki i ka hoomaka ana. Eia ka Ii 102 1/10 Anana.

Apana 2. Pahale. E hoomaka ma ke hiki Nema ma ka o keia pahale. Ueholo Ahau 66^o 30' hikiina 149 1/2 kapuai ma ka pahale o Kalukini; alaila Ahau 40^o Kom: 4 kapuai; a Ahau 61^o hiki: 9 kapuai i pili ana me ke Hanaike; alaila Ahau 31^o Kom: 58 1/2 kapuai i pili ana me ka pua o S. P. Manini, a hiki i ke ala olelo Palaki alaila Nema 55^o Kom: 45 1/2 kapuai ma ka lihi Nema o ke Ala Olelo a hiki i ke hiki Ahau o ke pua o S. P. Manini i kuhikuhia e G. M. Robertson (ma A. S. Turner i anaia mau ana) alaila hiki me ke ana o S. P. Kalama me ke S. P. Manini, Nema 35^o hikiina 27 1/2 kapuai, a me Nema 67^o Kom: 87 1/2 kapuai i mahela ana i ka funawai, i pili ana me ka pua o S. P. Manini a hiki i ka i ka hana ma ka lihi pali paakaa o ka hana a hiki i ka hoomaka ana. Eia ka Ii 155 2/3 Anana. Pua loa 258 Anana 13 Kapuai.

102-70
 258
 560-70 -

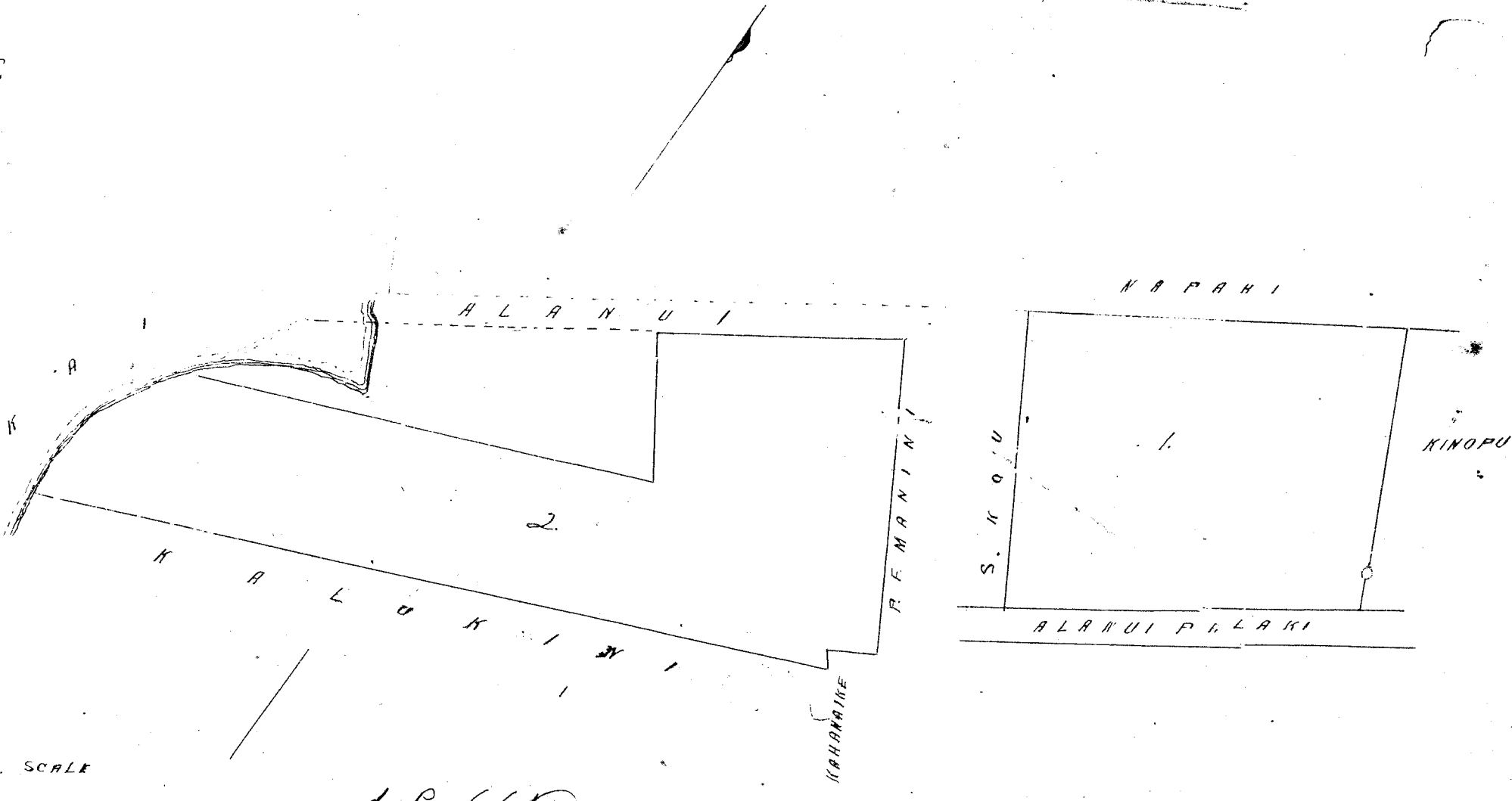

Heleu #20 Namaka.

Ua hoi mai oia no kona inoa ma Kapunohu, Honolulu, Oahu - ma ka mea, ua hoaiia keia inoa no
 Ihu ma i ka ia i ola ana o Hinopu, ma ka la 21, o Mii 1853, a ua hooia oia ma ka lihi me ke keakea ole
 ia, a i ka hookeuwaale ana a ma ka lihi mau Luma, ua maopopo ke mau lo'i pua lima hiki hiki no ma Hinopu i
 hookeuwaale, ma ka hookeuwaale, a ma ka hookeuwaale.

O keia ka maopopo e hookeuwaale ma Namaka, ke hookeuwaale hookeuwaale ma ka lihi o ke ana o Alodio, ma
 ka lihi ma i ka ke Hinopu hookeuwaale; alaila hookeuwaale ia ia ka Palapala oia Ii Alodio.

I ma ka lihi hookeuwaale ma ka hookeuwaale a me ke hookeuwaale ana i ka olelo Ihu.
 Ma ka lihi ma i ka ke hinopu a me ke pua ana i ka olelo ma ka lihi ma ka lihi.
 Ma ke kope ana i ma ka lihi Hinopu.
 No ka palapala hii.
 No ka hana ana ma ka la 21, o Mii 1853.

W. L. Lee
 G. M. Robertson
 J. H. Smith
 J. K. Kaulahao

No ke kope ana i ma olelo hoihoi 2 Awar
 No ke ana ana i ka la 30, o Maraki 1853.
 No ke kope ana
 No ke hoo holo ana i ka olelo ma ka la 2, o Iulai 1853

Uia ma palena.

Anaia i S. P. Kalama.

7/10

Aina ma Kapolea, Honolulu, Oahu, Oahu.

Uia. E hoomaka ma ke kiki Komohana o keia aina ma ka palena o Kapolea me Keawalo. A e holo Nema 30° Nihina 407 Pautu e pili ana me ka aina o ke Komohiki a hiki i ka aina o C. Magnett, - a e holo Nema 31° Nihina 135 Pautu e pili ana me ke C. Magnett a hiki i ka kiki Kahawai, - alaila Aka 47° Nihina 83 Pautu, a me Aka 29° Nihina 62 Pautu, a me Aka 53° 15' Nihina 116 Pautu ma ka kiki Kahawai oluna a hiki i ke Paniani, alaila Aka 29° Kom: 263 Pautu, heke; a me Aka 61 Nihina 79 Pautu e pili ana me Paniani a hiki i ke Komohiki, alaila Aka 25° Kom: 213 Pautu e pili ana me Komohiki a hiki i ka palena o "Keawalo," alaila Nema 66° Kom: 194 Pautu, a me Nema 52° Kom: 153 Pautu ma ka palena me "Keawalo" a hiki i ke hoomaka ana. Uia ka ili 1 ⁵³/₁₀₀ Eka.

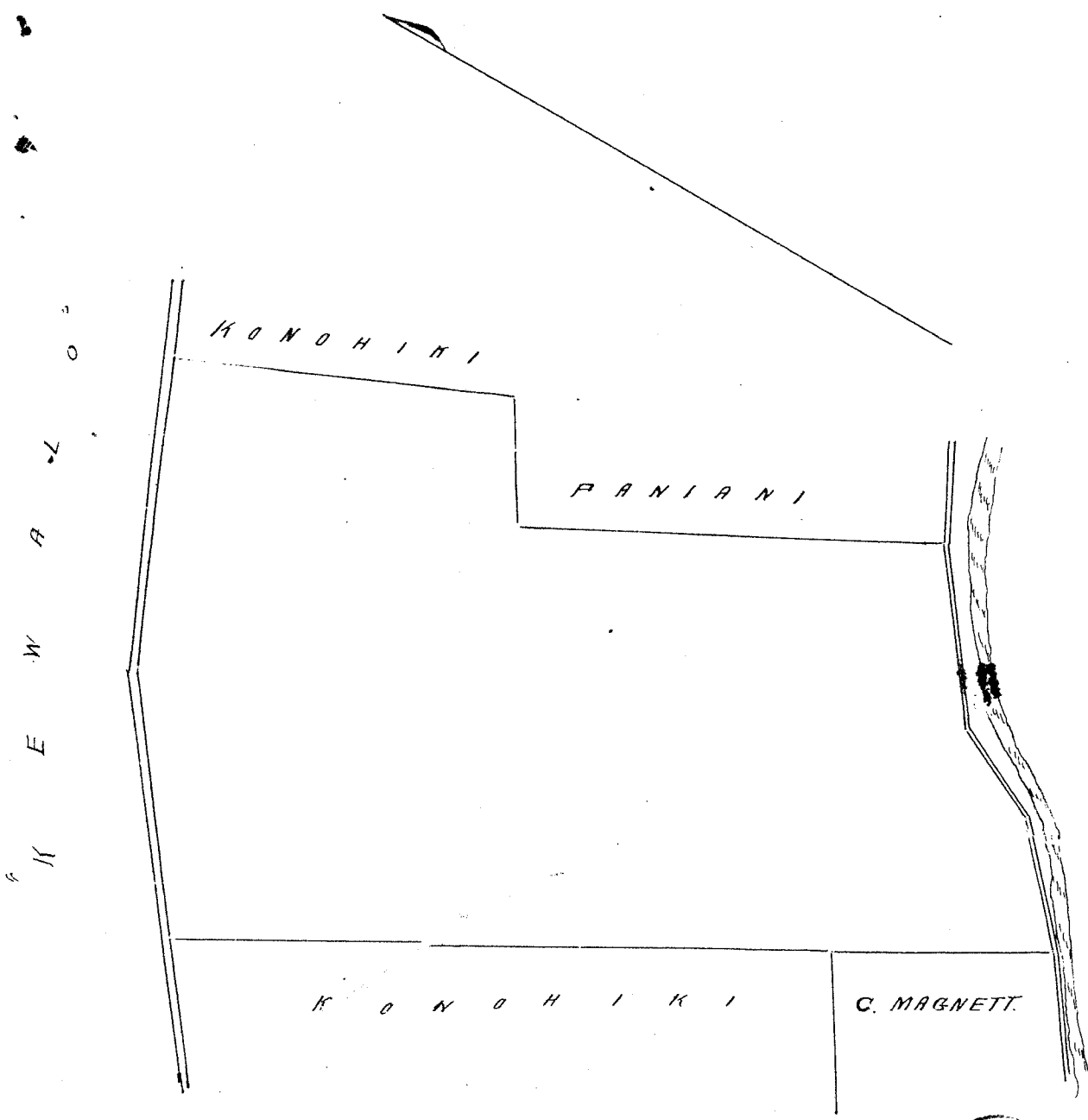

Hulu 24, FL. Ka ana ana.

Ua kivi mai oia i kona Apama aina ma Kaunakakai i ke Honolulu, Oahu e hiki me ma Kanawai o A. M. H. 1851 me ma Aina Pupu no ka mea, ma ka ia ia keia Apama me Kanawai mai i ka ana e moho Luanauhau ana o A. N. Williams a hiki i ke ana o M. K. Kaulahao e moho Nuhina ana, a ma moho keakea ole ia a hiki i keia manawa.

Oia ka matou e hooke me no Kaanaana, he hooloia hoi kona malalo iho o ke Amo Alo dio, ana ana mai oia i ke ke Cuspini hapaha, alaila hooke ia ia ka Palapala eila Nui Alo dio.

Pono ia ia ke ana me ka hooke holo a me ka hooke ana i ka olelo Penei;

W. L. Lee
 G. M. Robertson
 J. H. Smith
 J. K. Kaulahao

No ke ana ana me ke pa ana i ka olelo ma ka Nupapa.
 No ke kope ana i ma olelo hoihoi -
 No ke palapala hii -
 No ke hana ana ma ka la 24, o Iuli 1851.
 No ke kope ana i ma olelo hoihoi 3 Awar -
 No ke ana ana i ka aina ma ka la 28, o Iuli 1852. Uia \$5.00
 No ke kope ana
 No ke hoo holo ana i ka olelo 2, Iulai 1853.

Oia ma palena.

Anaia o S. P. Kalama.

Aina ma Kouhaukoi, Honolulu, Oahu.

3 Loi a me Tahuahale. E hoomaka ma ke kahi Akau o mai Loi o Kukui e pili ana me ka Loi o Keonekapu a e holo Nema 49' Kom. 78 Puku me Kukui; Akau 37' Kom. 91 Puku me Keonekapu; Akau 12' Hik. 23 Puku me Kahawali o S. Kae; Akau 49' Hik. 1 29/100 Kaul. me Kahawali o S. Kae. Neene Lina Nema 16 Puku me Kahawali o S. Kae; Akau 44' Hik. 1 24/100 Kaul. me Kahawali o S. Kae; Nema 46' Hik. 1 2/100 Kaul. me Kamoku; Nema 35' Kom. 40 Puku me Kamoku; Nema 43' Kom. 2 10/100 Kaul. me Keonekapu; Nema 19 1/2 Kom. 16 Puku me Keonekapu a puni i kahi i hoomaka ai ke ana ana: Ma ia Aina 353 Ana 21 Kapua.

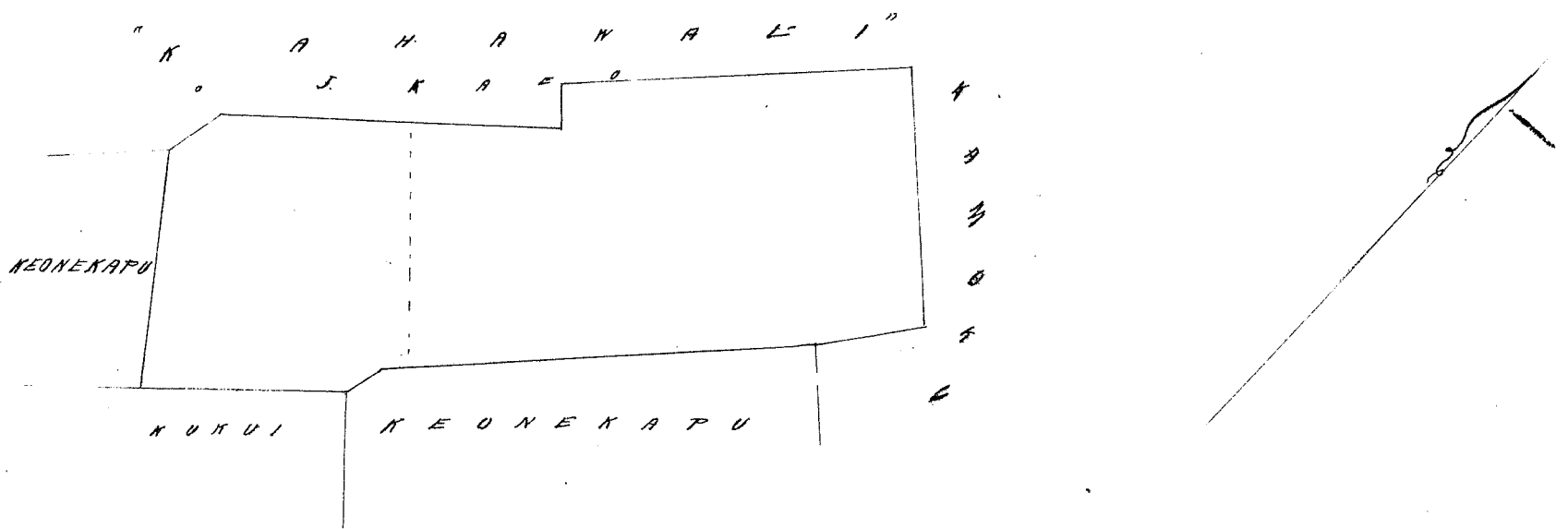

1/2 INCH X 3. C.S.

Hele 36 FL Kaulaku

Ua koi mai oia no kumu Apuna aina ma ka Ili o Aala i Honolulu ma Nema ma ka Moku o Oahu; no ka mea, ua loa i iaia keia wahi no Kamaitukuhilipu mai i ka wai e noho ana ana o S. A. Kuvakini no Oahu; a ua noho ka keia oleia a hiki i keia manawa.

Oia ka maku e hooke nei oia Kaulaku, ke kule ana iwi koma matato iho o ke Aro Hele. Ima e uku mai oia i ke ke Aupuni kapaka; alaila ua koi i ia ke palapala Pele Alodiv.

Pono nae ia ia ke uku no ka hooke hoko a me ka hooke ana i ka olelo. Ima

- W. L. Lee No ka rumi a me ke pua i ka olelo ma ka Muepa
- G. M. Robertson No ke kope ana i wa olelo koima
- J. H. Smith No ka palapala kii
- J. K. Kaulahao No ka hana ana ma kaula 12 o Januari 1852. Ukuia ke ana \$6.
- No ke kope ana i wa olelo a ma hooke 1/2 Awa
- No ke ana ana i ka la 14 o Aperila 1853
- No ke kope ana
- No ka hooke ana i ka olelo i kaula 2 o Iulai 1853.

	\$	Ken.
	4	00

Oia ma palena

Anaia o S. P. Kalama

Aina Kalo, 10 Loi o Tahuahale ma Aala Ili no Honolulu Oahu.

E hoomaka ma ke kahi Kikina o keia aina, e pili ana me ka auwaha Alani Liliha. A e holo i ka Nema 31' Kom. 1 34/100 Kaulahao ma ka kahi Alani oleli i holo ana iho o Kouhaukoi a hiki i ke auwai; Alaila iho i ka ma ka auwai Nema 60' Kom. 1 42/100 Kaulahao, a me Nema 49' Kom. 1 1/100 Kaulahao, a me Nema 70' Kom. 58 Puku a me Nema 52' Kom. 1 65/100 Kaulahao e pili ana ia mau aao me ka Ili aina o Koiu a hiki i ke Apuna a me ke Aupuni; Alaila Nema 44' Hik. 2 1/2 Kaulahao ma ka aina o ke Aupuni e moku ana ke pua maika o ke kope a me keia a hiki i ka kahi akau o ka auwaha Alani ke 10 Puku ke akau; Alaila holo pololei i ka 4 36/100 Kaulahao ma ka kahi akau o ka auwaha Alani Liliha a hiki i kahi i hoomaka ai.

Ma ka oia Aina 85 1/100 Eka

(Tama 1853)

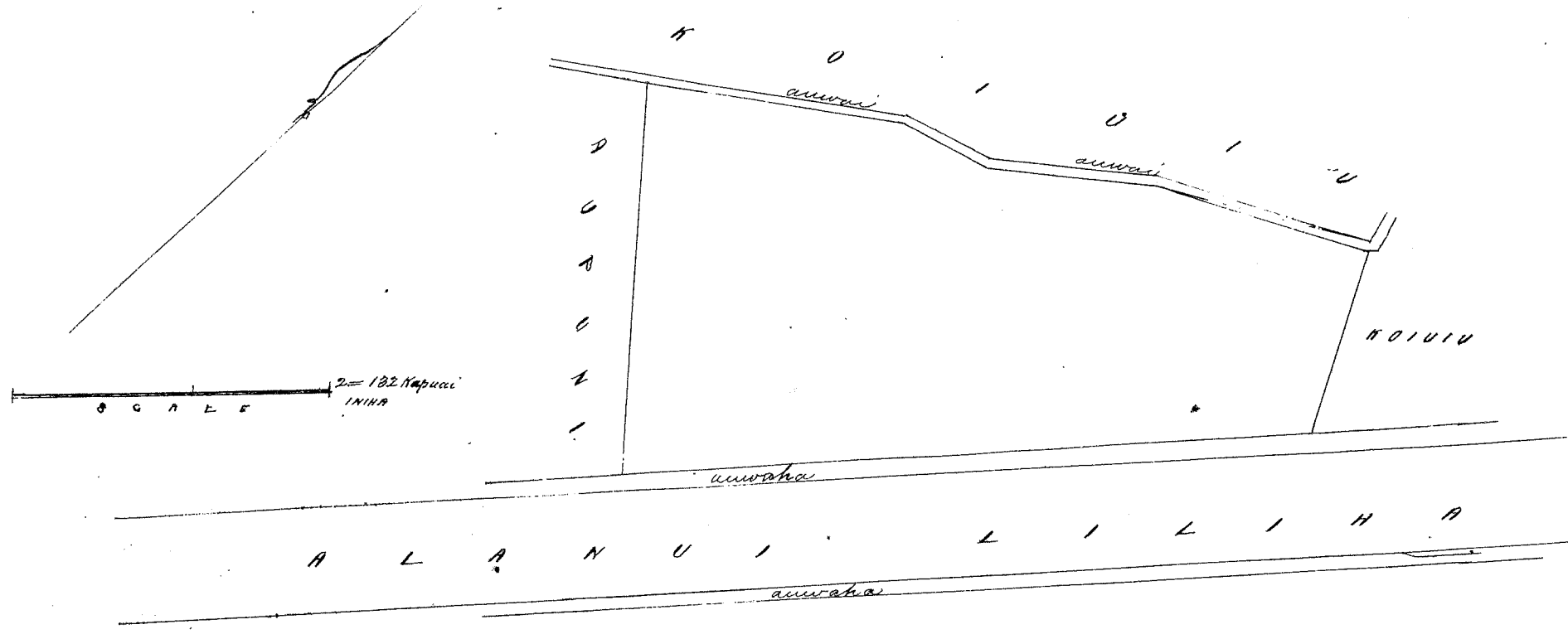

Sheu 37 FL Kaupē

Ua kōi mai oia no kona Apama aina ma Kauamoa i Naitiki ma Kona ma ka Moku o Oahu, no ka mea, ua hōia ia i ka wahi no Kalawa mai, a ua noho kōkēia oia a hiki i ka mānawa.

Oia ka mākou e hōko nei no Kaupē, he kōkēia hoi, kona ma ke Ao Aloha.
 Pono mai ia ia ke wai no ka hōhōhō a me ka hōhōhō ana i ka olelo. Penei,
 No ka oumi wai ke pāi ana i ka olelo ma ka Moku o Oahu

- W. L. Lee
- G. M. Robertson
- J. H. Smith
- J. K. Kaulahao

- No ke kōkē ana i ka olelo kōkē
- No ka palapala kōkē
- No ka hana ana i ka la 12 o Ianuari 1852
- No ke kōkē ana i ma olelo a ma hōkē 1/2 Aoao
- No ke kōkē ana i ka la 16 o Aperila 1852. Ukaia ke ana 3.
- No ka kōkē ana
- No ka hōhōhō ana i ka olelo i ka la 2 o Iulai 1853.

	Keu.
3	00

Oia ma palena

Aina o S. P. Kalama

O Lōi ma Kauamoa, Naitiki, Kona, Oahu.

He hōmuka ma ke kōkē i ka wahi oia Apama aina ma ka lili Aema o ka Kahawai o "Kalia" Aloha Aema 45° 30' Niki. 2⁶³ no Kaulahao ma ka palena o "Piliamoo" a hiki i ke kōkē i ka wahi oia, Alaila Aema 42° Horn. 1⁸¹ no Kaulahao ma "Piliamoo" a me ke Aupuni a hiki i ke A. Kahawai, he kōkē Aema oia, Alaila Aema 40° Horn. 2⁴⁵ no Kaulahao ma ke A. Kahawai no "Naiaka" a hiki i Kahawai o "Kalia", Alaila Aema 29° Niki. 1⁶³ no Kaulahao ma ka lili Kahawai a hiki i ka hōmuka i. Ma ia Aema 45/100 Eka

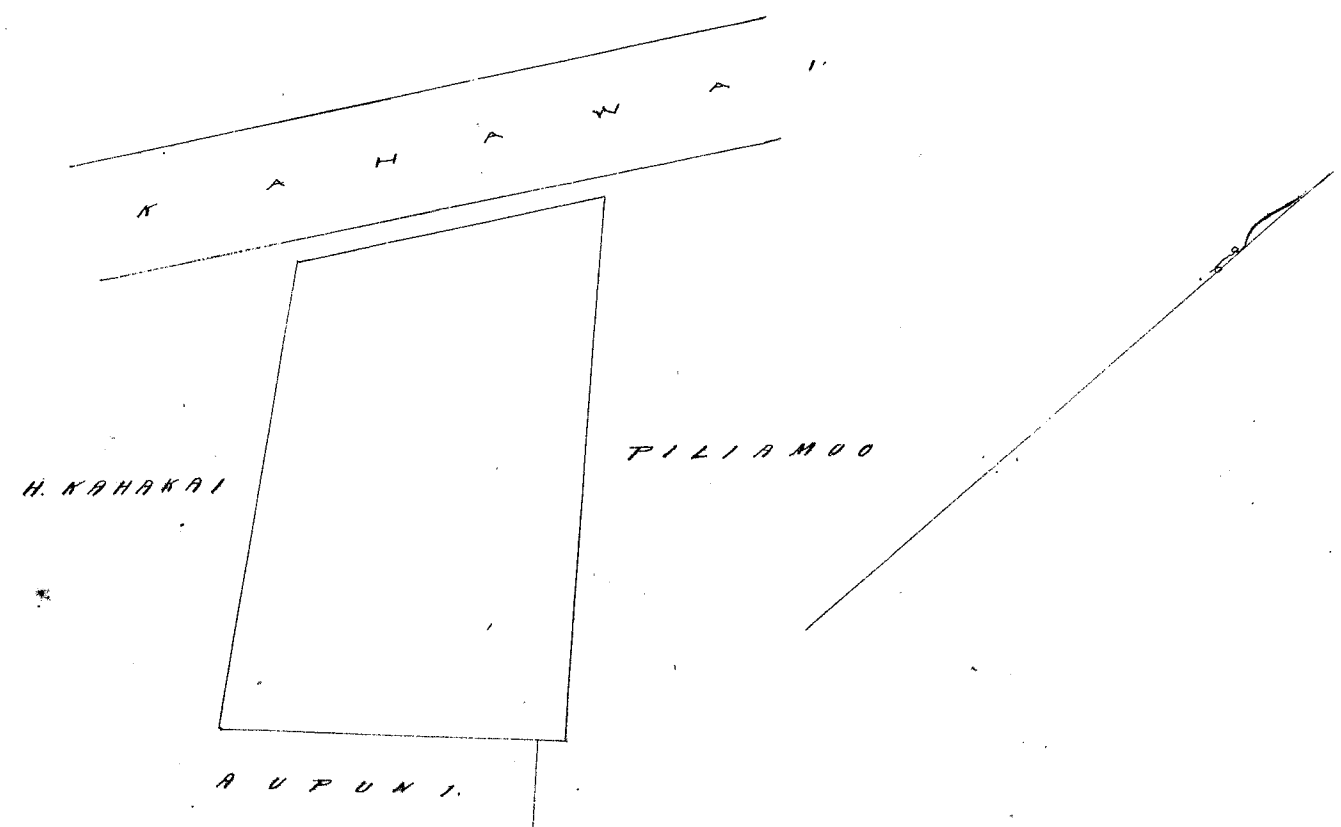

Ua kōi mai oia no kōna Apana Aina ma ka Ii. Aewa i Honolulu ma kōna ma ka Moku-puni o Oahu, no ka mea, ua loa ia ia keia wahi no Makahuluhulu mai i ka makahiki 1843, a ua noho keakea oleia a hiki i keia manawa.

Oia ka mākou e hōko nei no Mahoe Nui; he kuleana hoi kōna malalo iho o ke Ano Alodio. Ina e ukui mai oia i ke ke Aupuni hapaha; alaila, ua kōpono ia ia ka Palapala Sila Alodio.

Pono māc ia ia ke ukui no ka hōhokolo a me ka hōhokolo ana i ka olelo. Penei
No ka rumi a me ke pui ana i ka olelo ma ka Nupepa

- W. L. Lee
 - G. M. Robertson
 - C. H. Smith
 - J. Kekaulaha
- No ke kope ana i ka olelo koinoa
 - No ka palapala kii
 - No ka hana ana i ka la 13 o Ianuari 1852.
 - No ka kope ana i ma olelo a ma hōike 1/3 Awar
 - No ke ana ana i ka la 5 o Iulai 1852. Ukuia ke ana ana 2.
 - No ke kope ana
 - No ka hōhokolo ana i ka olelo i ka la 2 o Iulai 1853.

3	00

Oia na palena Anai o S. P. Kalamia

I Poi Kuleana ma Aewa, Honolulu, Oahu
E hōmaka ma ke kīhi Komohana makai o keia kuleana ma ka pōhaku i hōailonia x e pili ana me ke Makahuluhulu a me ka aina o ke Aupuni, a e holo Akau 56° Nihina 87 Pūku, a me Kōna 54° Nihina 3⁹⁶ Kaulaha ma ke ke Aupuni a hiki i ke Namai, - Alaila Kōna 36° Kōna 49 Pūku ma ke Namai a hiki i ke Makahuluhulu, - Alaila huli a holo i ka hiki i hōmaka i a pūni keia Loi. Kūpaha Eka.

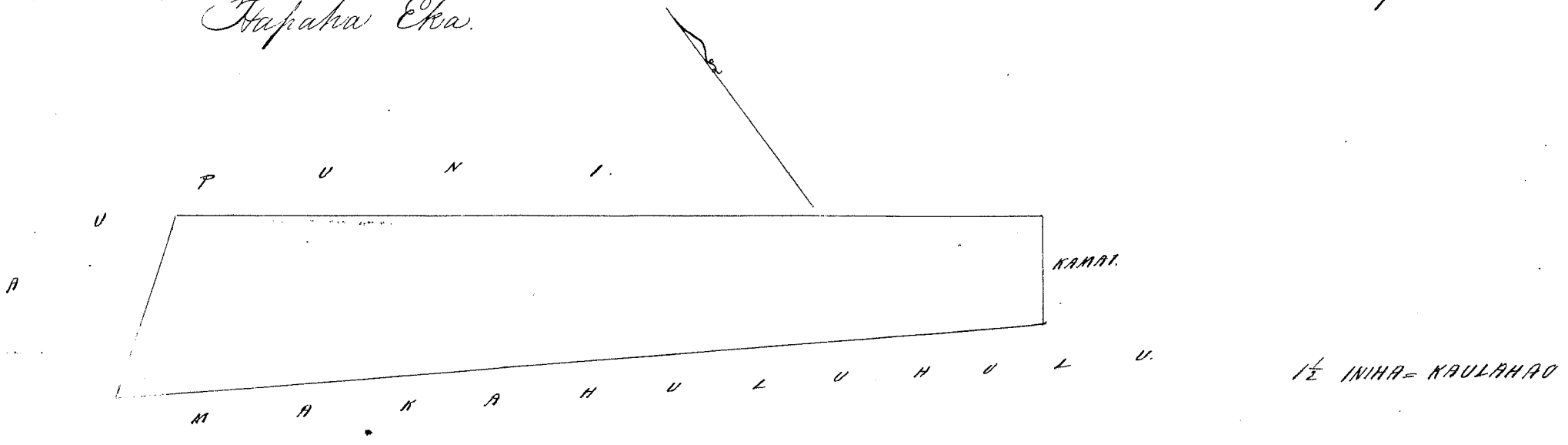

Ua kōi mai oia no kōna wahi Pahale ma Kawaiaha i Honolulu ma kōna ma ka Moku-puni o Oahu, no ka mea, ua loa ia ia keia wahi no Kaimama mai kōna kōna, mua, a ua loa hoi ia Kaimama i ka wa o Kamehameha II makōpe mai o ke kōna ia Kōna nei, a ua noho keakea oleia a hiki i keia manawa. Ika, ua keakea mai o Kamaka a me Kaiōka me ke kōi mai, aka, i ka lōhe ana i ka olelo a ma hōike i ke māka, ua māpōpō, aole he kuleana o Kamaka a me Kaiōka ma keia wahi, a ua māpōpō hoi ke kuleana o Niau ma keia wahi, a ke noho mai nei no malaila a hiki i keia manawa.

Nolaila, oia ka mākou e hōko nei no Niau; he kuleana hoi kōna malalo iho o ke Ano Alodio. Ina e ukui mai oia i ke ke Aupuni hapaha; alaila, ua kōpono ia ia ka Palapala Sila Alodio.

Pono māc ia ia ke ukui no ka hōhokolo a me ka hōhokolo ana i ka olelo. Penei
No ka rumi a me ke pui ana i ka olelo ma ka Nupepa

- W. L. Lee
 - G. M. Robertson
 - C. H. Smith
 - J. Kekaulaha
- No ke kope ana i ka olelo koinoa
 - No ka palapala kii
 - No ka hana ana i ka la 8 o Feb. 5 o May 8 o Iulai 1853.
 - No ka kope ana i ma olelo a ma hōike 1 1/2 Awar
 - No ke ana ana i ka la 28 o Apirila 1853.
 - No ke kope ana
 - No ka hōhokolo ana i ka olelo i ka la 11 o Iulai 1853.

7	00

Anaia e S. J. Kalama.

Tahale ma Kawaiakao, Honolulu, Oahu.

E komaka mai ke kahi Komohana o keia paha i pili ana me ke kahi Akau o ka Puhalahua a me ke Alanui Hale Pule, a e holo hema 28°15' Kikina 190 Pauku me Puhalahua a hiki i ke kahi Hema. Aiaia Akau 59°30' Kikina 225 Pauku i pili ana me ke Alanui Hema, - Aiaia Akau 38°30' Kom. 212 Pauku me ke Ala a me ka paha o Puhikakaino a hiki i ke Alanui Hale Pule, - Aiaia Hema 53° Kom. 190 Pauku me ke Alanui a hiki i ka komaka ana.

Eia ka Ili 505 Anana

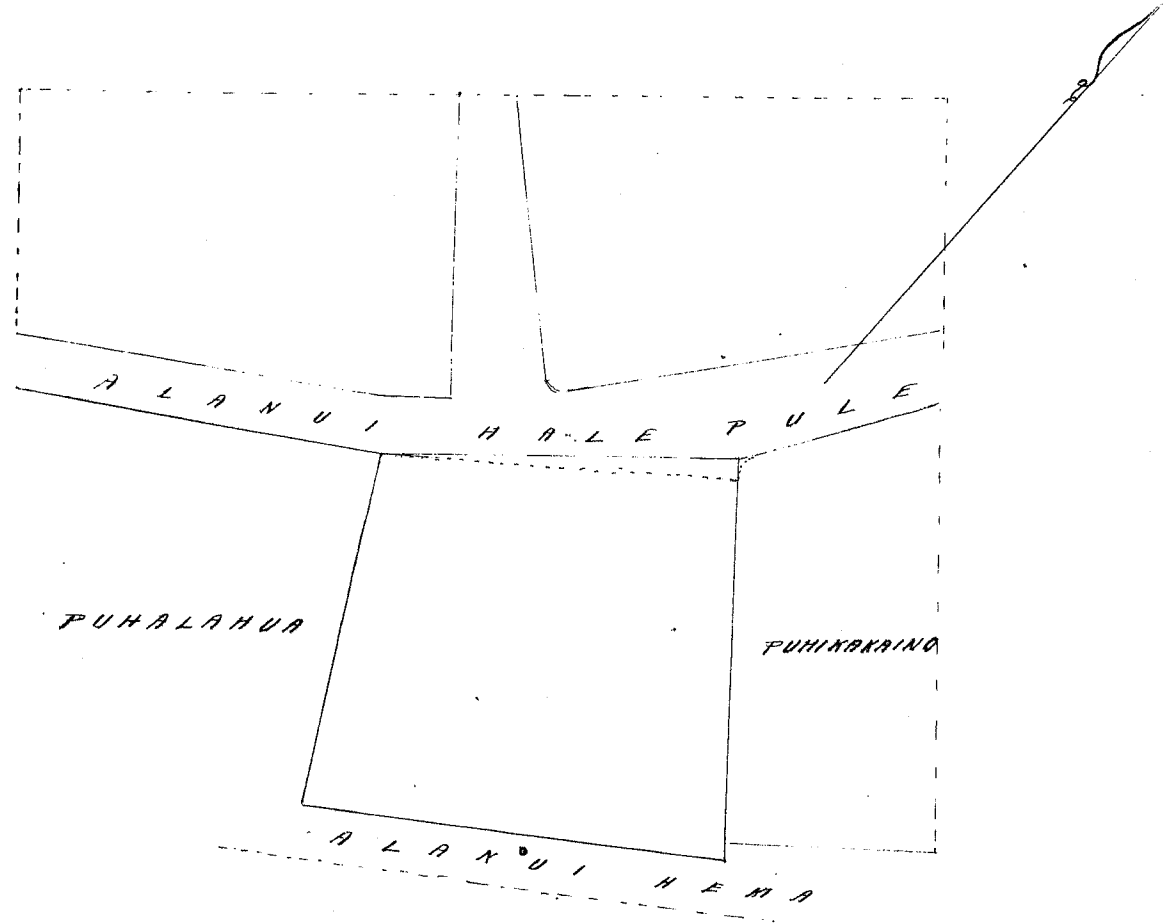

Hulu 1612 Kahakai (no Naamiani)

Ua koi mai oia no kona mau Apama aiaa ma ka Ili o Waikuhalulu i Honolulu ma Kona, ma ka Mokupuni o Oahu, no ka mea, ua loa ia ia i keia wahi no Mooe mai ka makuakane o Naamii i ka wa no e ola ana o Naamii mamua aku o ka makahiki 1836, a ua roho keakea oia a hiki i ka la 11 o Iune iho nei, akahi no a lokia ka mea keakea o C. Naamiana, Aka, i ka hooloholo ana me na hoike a me na aias elia i koi mai, ua hoi mai na hoike ike pono a he kamaaina mua hoi ma kela aiaa, he keole no kela loi o "Poipupu", ua hana keole no i ka wa kahiko a ua mau no ke keole ana, wahi ana hoike, a hiki i ka makahiki 1847, lilo kela aiaa ia Kahakai, oia ka luwa, ia manawa ka paha ana o ke keole ana; aka, ua hua ka olelo hoi i na olelo a ka mea hua, aka, i ka manawa ana, ua magi po he keole o "Poipupu loi", a ua hooliloia kw ia loi no ke Honolulu, a o na loi ahiw i ke, e hooiwa kw ia no Kahakai a i kona hooi ilina.

Oia ka maku e hooho mi no Kahakai, a ia Naamiani, he kuleana hoi kona maalo iho o ke Alo Alo. Ima e hui mai oia i ko ke Apama hapaaha, aiaia, ua huihono ia ia ka Palapala Sila Alo Alo.

Pono nae ia ia ke uku no ka hooloholo a me ka hooloholo ana i ka lelo. Penei:

- No ka rumi a me ke paha ana i ka olelo ma ka Nupepa
- No ke kope ana i ka olelo, hoiwa
- No ka palapala hui
- W. L. Lee
- No ka hana ana i ka la 11 o Iune 4, 21 & 30 o Iune 1853
- G. M. Robertson
- No ke kope ana i na olelo a na hoike 3 Awa
- No ka ana ana i ka la 2 o Iulai 1853
- I. Kikauhoo
- No ke kope ana
- C. S. Smith
- No ka hooloholo ana i ka la 11 o Iulai, 1853 i ka olelo

	\$	Ken.
	7	00

Eia ma paha.

Anaia e S. J. Kalama.

Aina ma Naikahalulu Honolulu Oahu.

Apana 1. Loi. O hoomaka ma ka pohoaku, kahi Aema o keia lani e pili ana me ka auwai a me ka Loi koeli "Poi-puupuu" ka inoa i kooia e ke Honolulu, A e holo Aka 44° 30' Nomi 110 Pautu e pili ana me "Koeli" Poi-puupuu "ka inoa a hiki i kuauna lani kahawai oluna, - Alaila Aka 50° 30' Nomi 111 Pautu ma kuauna lani kahawai oluna a hiki kokoke i kekahi pohoaku ma kae o ka wai auwai o "Naikahalulu" ka inoa, - Alaila Aema 64° Nomi 70 Pautu e pili ana me ka auwai i ka lani auwai Eono Pautu, - Alaila iho ika ma ka lani Aka o ia auwai e pili ana me na aina o Naikohua, Nauhii a me Pale a hiki i ka hoomaka ana. (Eia ke Kaula lani o ka auwai - Aema 28° 30' Nomi, 1 ma 70 Pautu, neeme Lima Aka 12 Pautu anahua auwai, - Ma 110 Pautu pili auwai a pumi. Eia ka Ili 134 Apana.

Apana 2. Loi. O hoomaka ma ke kahi Aka o keia Apana aina e pili ana me koeli "Poi-puupuu" ma ka lani kahawai oluna. A e holo Aema 45° Nomi 135 Pautu e pili ana me "Poi-puupuu" a hiki ika lani Aema o ka auwai e pili ana me ka aina o Hale, - Alaila Aema 29° Nomi 65 Pautu, a me Aema Nomi 23 Pautu a me Aema 27° Nomi 35 Pautu a me Aema 25° 30' Nomi 65 Pautu, a me Aema 11° Nomi 45° Pautu e pili ana me ka aina o Hale a hiki ika pohoaku papapa. Alaila Aema 39° 15' Nomi 168 Pautu ma kuauna lani o ka pumi pohoaku a hiki ika auwai, - Alaila Aka 35° Nomi 182 Pautu ma ka lani mauka o ka auwai e iho ana i kahawai me Honolulu a hiki i ka lani kahawai, - Alaila holo pohoaku ika ma ka auwai Aema o ke kahawai a hiki i ka hoomaka ana. Eia ka Ili 636 Apana

INHA SCALE

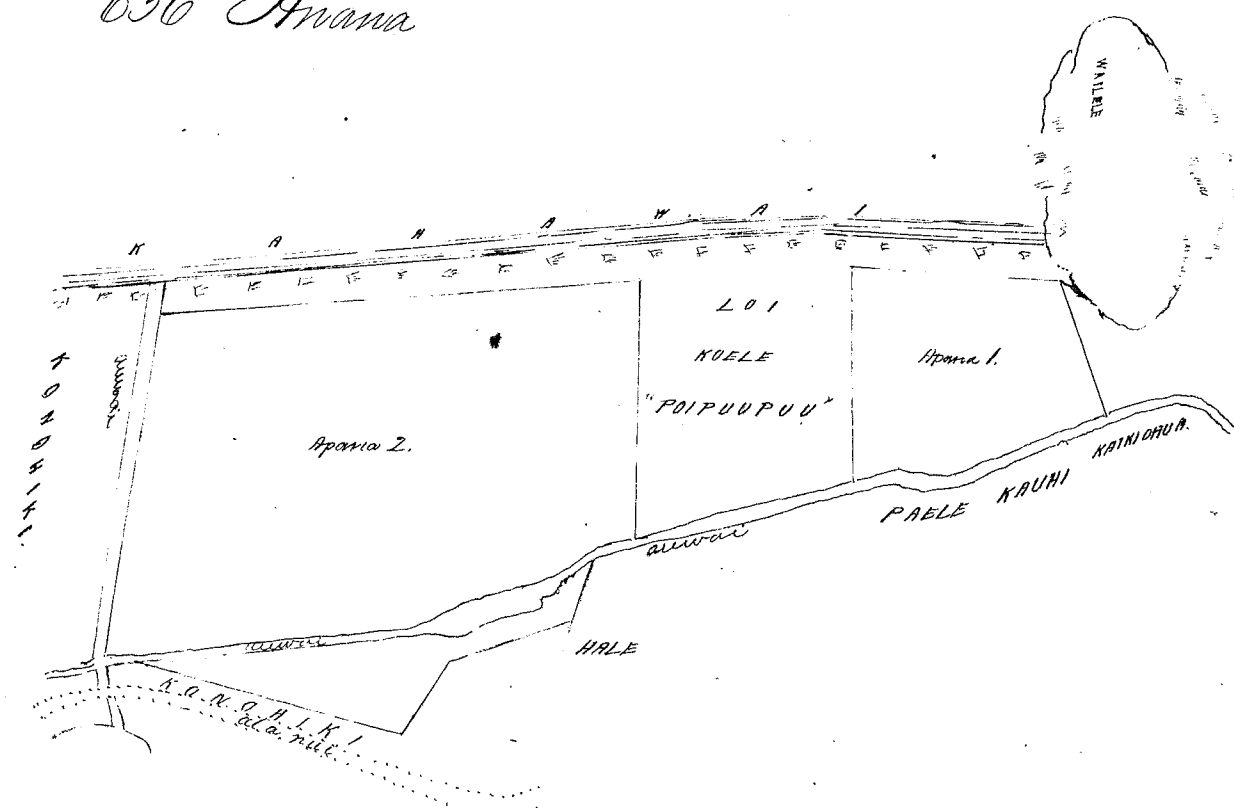

Hele 1082 Kekuanui (no H. Kahakai)

Ua koi mai oia no kona Pahale ma Honolulu ma Honolulu ma ka Mokupuni o Oahu no ka mea, ua loa ia ia keia wahi no kona mau kupuna mai i ka manawa Naakumana, a ua noho keakea oia a hiki ika malamalama o Iune 1848, manao o Kaiwi e hakea i keia wahi, me ka manao nona keia wahi ma mua, aka, i ka hui ana mai a na hoike, aole he pa o Kaiwi, aole he pale, aole hoi e noho ana ma kela pa, aole no hoi e noho ana mai oia mai. Alaila, ua hoole makou i ka Kaiwi kuleana ma keia pa, a ua hoia i o aku makou i ka Kekuanui kuleana ma keia pa, a paha e mau akuwai

Oia ka makou e hoko nei no Kekuanui aia H. Kahakai, ke kuleana hoi kona malalo iho o ke Ano Alodis. Aia e uku mai oia i ka ke Aupuni hapaha; alaila, ua kupona ia ia ka Palapala Sila Alodis

Tono ma ia ia ke uku no ka hoholoholo a me ka hoholo ana i ka olelo, Peni. -

- W. L. Lee
- G. M. Robertson
- C. H. Smith
- J. K. Kakaiaho

- No ka rumi a me ke paia ma ika olelo ma ka Kupepa
- No ke kope ana ika olelo koina
- No ka palapala kii
- No ka hana ana ika ka 7 o Iune 1848 & 22 o Maraki 1853.
- No ke kope ana ika olelo a ma hoike 2 Awa
- No ke ana ana ika ka 2 o Aperila 1853 Ukuia ke ana ana \$4.00
- No ke kope ana i
- No ka hoholo ana ika ka 11 o Iulai 1853.

Eia ma pakuwa.

Anaia e S. P. Kalama

3 00

Ua hale ma Komohana i Honolulu, Oahu.

E hoomaka ma ke kahi Hikina o keia pahale e pili ana me ke Alanui Alii Waihu a me ke kahi Akau o ka pahale o Kaalua... Alaila Aka 62° Nomi. 128 Pautu e pili ana me kahi waihu wale a hiki i ka Apungu Aina o ke Aupuni no ka bipi... Alaila Aka 41° 30' Nomi. 264 Pautu ma ka pu bipi Aupuni a hiki i ka pu o Kawahumanu... Alaila Aka 56° Hikina 105 Pautu... me Aka 27° 30' Nomi. 26 Pautu e pili ana me ka pu o Kawahumanu a hiki i ka pu o Kahiwa... Alaila Aka 54° Hikina 164 Pautu e pili ana me ka pu o Kahiwa a hiki i ke Alanui Alii Waihu... Alaila Aka 47° Hikina 98 Pautu ma ka kahi o ka alanui a hiki i ka hoomaka ana.
Eia ka Ii 708 1/2 Anana

100 Pautu INIHA SCALE

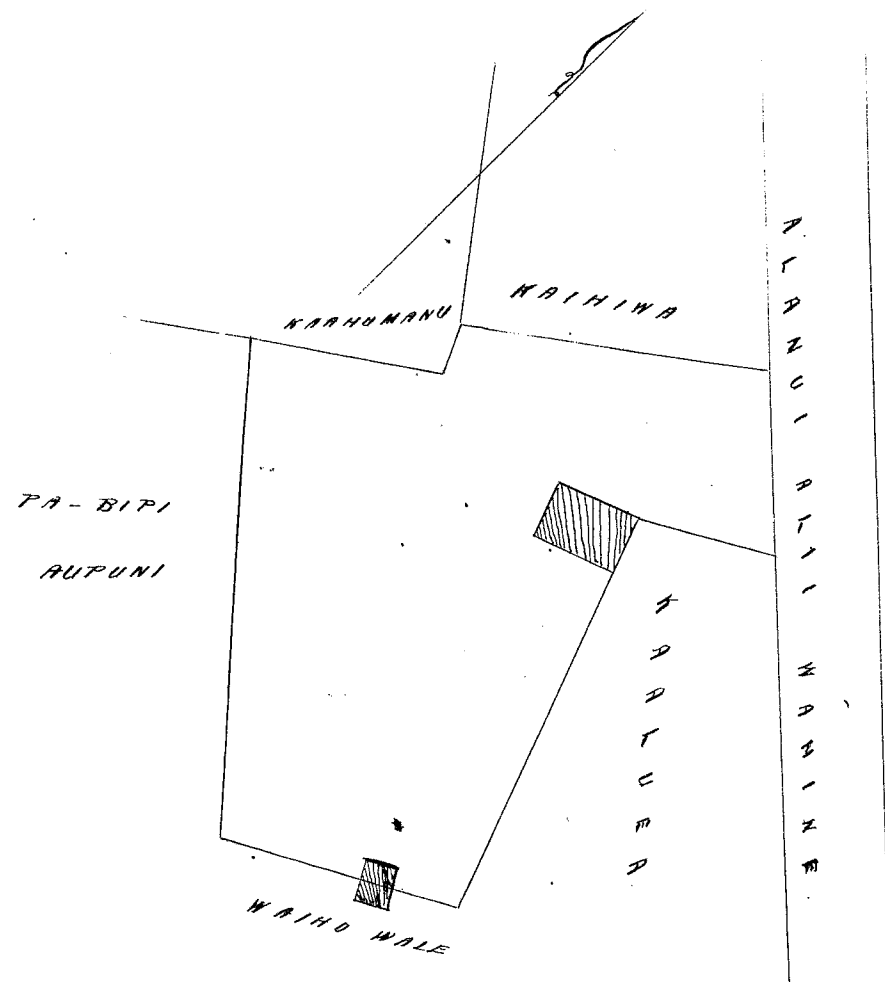

Hele 1 FL Kawakahi

Ua hoi mai oia no kona Apawa Aina ma ka Ii o Kuaiala i Honolulu, ma Kona, ma ka (Waihu) o Oahu, e like me na Kanawai o ka Māhāhāhi 1851, no na Aina Pāpau; no ka mea, ua lapa iia iia hiai wahi no Kaawa mai mamua ahu o ka maku ana o Kawahumanu, a ua mōkōkekaa oia a hiki i keia manawa.

Oia ka mukou e hōke me i no Kawakahi; he kuleana hoi kona malalo iho o ke Ano Aloia. Ina e uku mai oia i hōke Aupuni hapahapa alaila, ua hihihi ia ia ka Palapala Sila Aloia.

Pono mai ia ia ke uku no ka hōkolokolo a me ka hōhōlo ana i ka olelo, Puni. —

W. L. Lee
G. M. Robertson
J. H. Smith
J. Kikaniani

No ka rumi a me ke puai ana i ka olelo ma ka Māhele
No ke kope ana i ka olelo hoiwa
No ka palapala hui
No ka hana ana i ka la 16 o Dekemaba 1851.
No ke kope ana i ma olelo a ma hōke 1/2 oia
No ke ana ana i ka la 24 o Mei 1853. Ukiia ke ana ana \$4.00.
No ka kope ana
No ka hōhōlo ana i ka olelo i ka la 11 o Iulai 1853.

	Hen.
	3.00

Eia ma palena. Anaia e S. P. Kalamau.

Aina ma Kuaiala, Honolulu, Kona, Oahu.
Alaila. E hoomaka ma ke kahi Hikina o keia aina, Alaila Aka 42° 15' Nomi. 358 Pautu e pili ana me ka aina o ke Aupuni a hiki i ke Kūpee. — Alaila Aka 41° Nomi. 86 Pautu; me Aka 12° Nomi. 36 Pautu; me Aka 16° Hikina 49 Pautu a hiki i ka fohaku ma ka kahi Aina o ka auwai; a me Aka 38° Hikina 268 Pautu e pili ana me ka auwai i waena o keia me ka aina o Kūpee a hiki i ke Auwai. — Alaila Aka 53° Hikina 152 Pautu me ka Auwai a hiki i ka hoomaka ana.

Eia ka Ii 576 Anana.

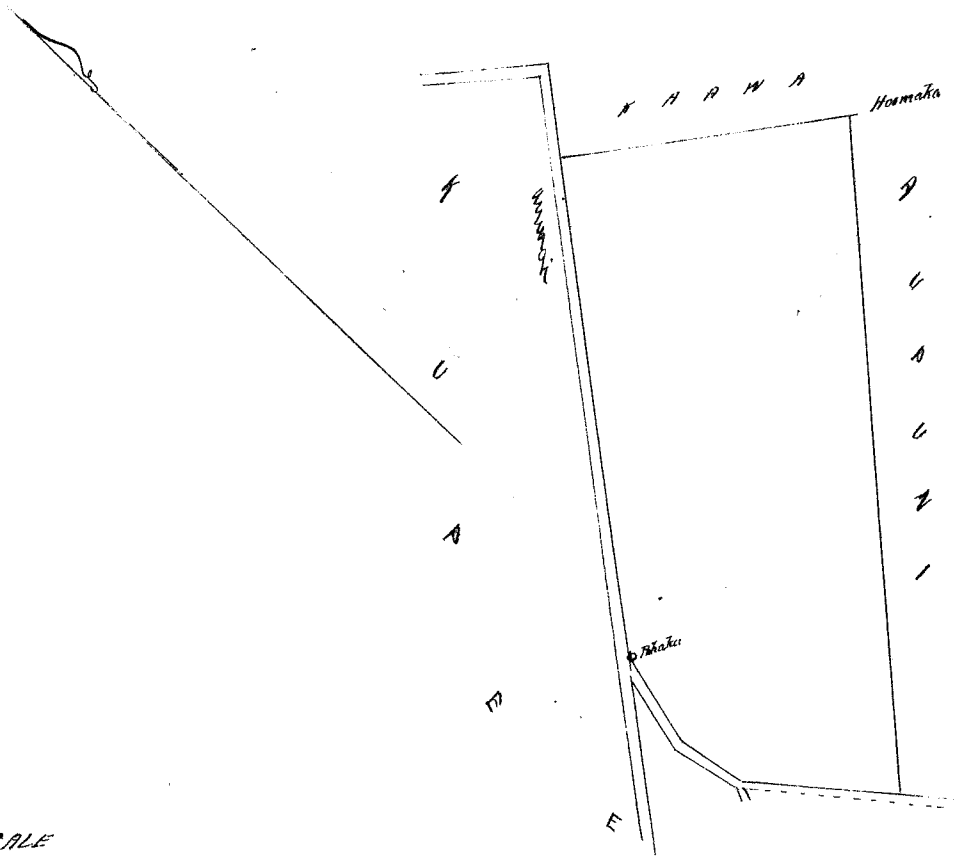

100 POUKI INCHA SCALE

Helu 3 FL Kapo

Ua hoi mai oia no kona Apana Aina ma Hauhaueki i Honolulu, ma kona, ma ka Mokupuni o Oahu e like me ma Kanawai o ka Makahiki 1851, no na Aina Papi; no ka mea, ua hooa ia ia keia wahi no Hanikou mai i ka manawa mamua aku o ka make ana o Niwau i ka makahiki 1839, a ua hooa keakea oleia a hiki i keia manawa.

Oia ka makou e hooke me no Kapo, he kuleana hoi kona malalo iho o ke Aua Abdio. Ina e iku mai oia i ho ke Aupuni hapaha, alaila, ua hooa ia ia ka Palapala Sila Abdio.

- No ka oia iho ke iku no ka hooke hooke a me ka hooke ana i ka olelo. Ienei:
- No ka oia a me ke hooi ana i ka olelo ma ka Napepa
- No ke hooi ana i ka olelo koma
- No ka palapala kii
- No ka hooa ana i ka la 16 o Ipekemaba 1851.
- No ke hooi ana i na olelo a ma hooi 13 Aua
- No ke ana ana i ka la 10 o Maraki 1853. Ukuia ke ana 14.
- No ke hooi ana
- No ka hooke ana i ka olelo i ka la 11 o Iulii 1853.

W. L. Lee
 G. M. Robertson
 O. H. Smith
 J. Kikaulaha

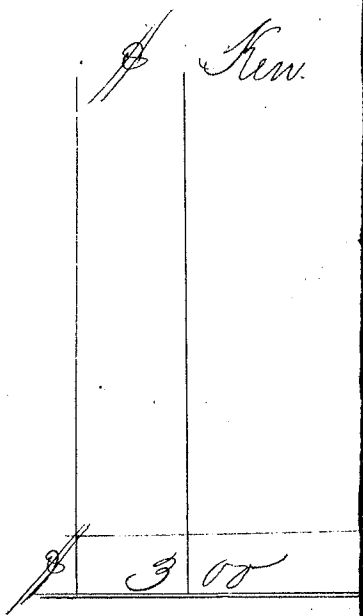

Oia ma palama. Anaa i S. P. Kalamā.

Aina ma Hauhaueki Honolulu, Oahu.

5 Poi. E hoomaka ma ke kiki Kema o keia aina e pili ana me ke kiki Hikiina ma ka o ka aina o Keonekapu, a e hooi Maau 28° Kom. 67 Poutu e pili ana me Keonekapu a hiki i ka auwai me Kamoku, Alaila Maau 38° Hikiina 28 Poutu; me Maau 53° Kom. 24 Poutu; me Maau 12° Kom. 39 Poutu; me Maau 70° Hikiina 43 Poutu; a me Maau 36° 30' Kom. 265 Poutu e pili ana me Kamoku a hiki i keia Apana Aina o ke Aupuni ma Hauhaueki, - Alaila Maau 62° 30' Hikiina 154 Poutu, a me Maau 43° 15' Hikiina 98 Poutu e pili ana me ka aina Aupuni a hiki i ho Koluua, - Alaila Kema 30° 45' Hikiina 240 Poutu e pili ana me Koluua a hiki i ka uake o ka auwai o Koiuu, - Alaila Kema 7° Hikiina 95 Poutu ma ka auwai me Kaapuni a hiki i ho Kamau, Alaila Kema 69° 45' Kom. 189 Poutu e pili ana me Kamau a hiki i keia hoomaka ana.

Oia ka Ii 700 Anana

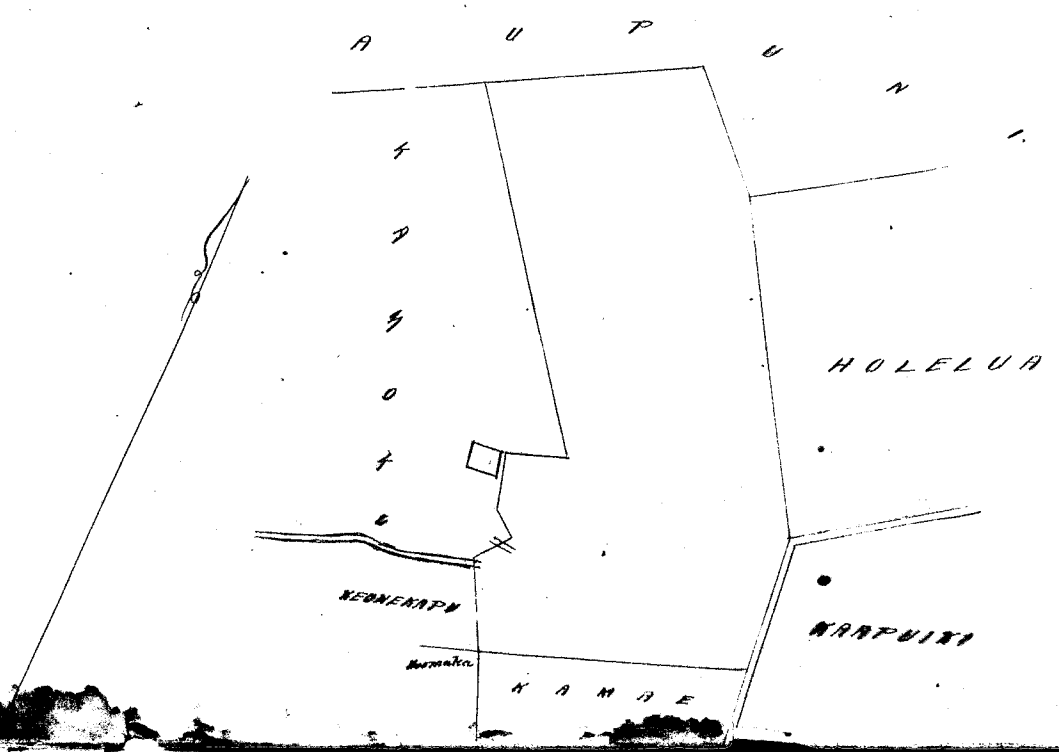

3/4 INCHA = 100 POUKI SCALE

Helu 9 FL Kewa

Ua hoi mai oia no kona Apana Aina ma Kuwili i Honolulu, ma Kona, ma ka Mokupuni o Oahu, e like me ma Kanawai o ka makahiki 1851, no ma Aina Papu; no ka mea, ua loa ia ia keia wahi no Kanawai mai i ka wa o noho Aiaaina ana o Kewa no Oahu nei, a ua moho keakea oleia a hiki i keia manawa.

Oia ka makuu e hooho nei no Kewa; he kuleana hoi kona malalo iho o ke Ano Alodio. Ina e uku mai oia iho ke Aupuni hapaha; alaila, ua kupaia ia ia ka Palapala Ika Alodio.

- W. L. Lee
 - G. M. Robertson
 - J. H. Smith
 - J. Kekaulaha
- No ka rumi a me ke pua ana i ka olelo ma ka Napepa
 - No ke kope ana i ka olelo hoina
 - No ka palapala kii
 - No ka hana ana i ka la 17 o Dekemaba 1851.
 - No ke kope ana i ma olelo a ma hoike 1/2 Aoa
 - No ka ana ana i ka la 17 o Aperila 1852. - Ukuia ke ana #3.
 - No ke kope ana
 - No ka hooholo ana i ka olelo i ka la 11 o Iulai 1853.

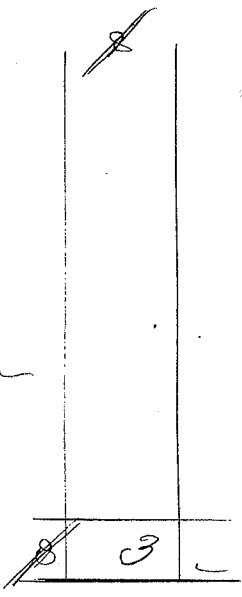

Oia ma palena. Aina o S. P. Kalama.

Aina ma Kuwili, Honolulu, Oahu.

2 Loi. E hoomaka ma ke kiki Aha o keia aina e pitia ana me ka aina Moaia; a e holo Aina 44° 45' Kom. 312 Paku ma Kekai; - Aina 54° 51' Kom. 239 Paku ma Kamaala; - Aina 75° 30' Kom. 103 Paku ma Auwai; Aina 40° 51' Kom. 118 Paku ma Kamaua; Aina 13° 30' Kom. 89 Paku ma Kamaua; Aina 49° 30' Kom. 95 Paku ma Kamaua a hiki i ke kiki Aina o ka Loi o Moaia; Alaila huli a holopolele i ka hoomaka ana a pua keia.

Oia ka Ii 92/100 Eka.

K E K A I

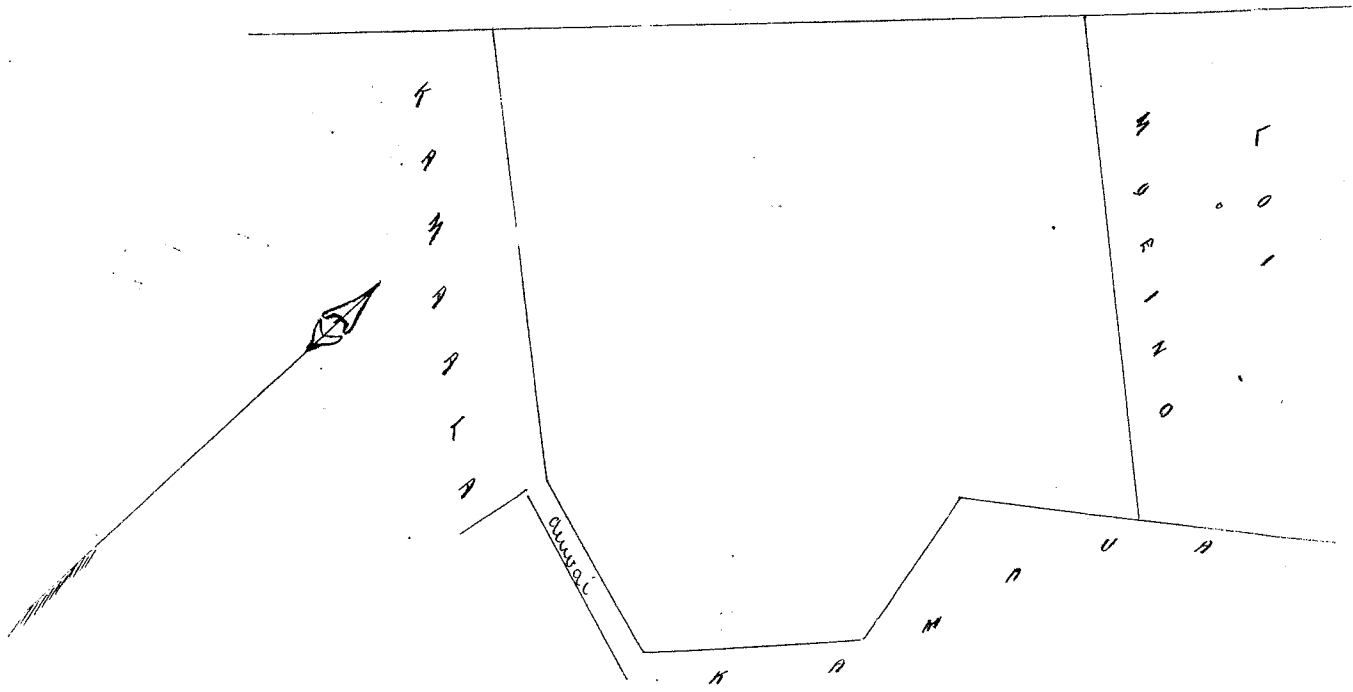

SCALE INHA - 100 FOMU

Helu 31 FL Waihinalo

Ua hoi mai oia no kona Pahale ma Kalii i Waikiki ma Kona, ma ka Mokupuni o Oahu; e like me ma Kanawai o ka makahiki 1851, no ma Aina Papu; no ka mea, ua loa ia ia keia wahi no M. Kekaulaha mai i ka makahiki 1849, a ua moho keakea oleia a hiki i keia manawa.

Oia ka makuu e hooho nei no Waihinalo; he kuleana hoi kona ma ke Ano Alodio. Ina e uku mai oia iho ke Aupuni hapaha; alaila, ua kupaia ia ia ka Palapala Ika Alodio.

- W. L. Lee
 - G. M. Robertson
 - J. H. Smith
 - J. Kekaulaha
- No ka rumi a me ke pua ana i ka olelo ma ka Napepa
 - No ke kope ana i ka olelo hoina
 - No ka palapala kii
 - No ka hana ana i ka la 6 o Januara 1853.
 - No ke kope ana i ma olelo a ma hoike 1/2 Aoa.
 - No ka ana ana i ka la 7 o Iune 1852.
 - No ke kope ana
 - No ka hooholo ana i ka olelo i ka la 11 o Iulai

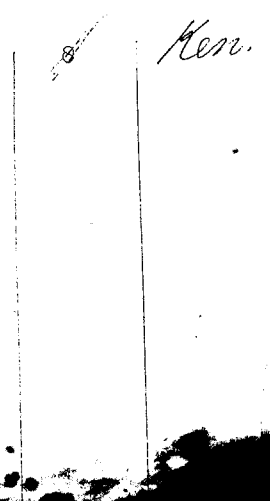

Ken.

Pahale ma Kalua Kikiki, Kona, Oahu.

E hoomaka ma ke kiki Akau o keia Pahale ma ke pua, lili. Hema o ke Alanui Honolulu, a e holo kama 57. Kom. 230 Pautu, me Akau 87.30 Kom. 97 Pautu a pili ana me ke Paele ma ke palena o Pawa me Kalua a hiki i ke palena o Pawa Jane Ii. Alaila kama 12.30 Hikiina 125 Pautu ma ke auwai ho komo kai a hiki i ke kiki Kona kama Akau o ke Aupuni aia o ke Aupuni i manawa no Auwa, - Alaila Akau 86.30 Hikiina 230 Pautu, me kama 41. Hikiina 93 Pautu, me Akau 66.45 Hikiina 56 Pautu a pili ana me Kona kiki a hiki i ke Alanui Aupuni, Alaila Akau 17. Kom. 311 Pautu ma ke lili matakai o ke Alanui Aupuni a hiki i ke hiko matakai ana.

Oia ka Ki 687 Anana.

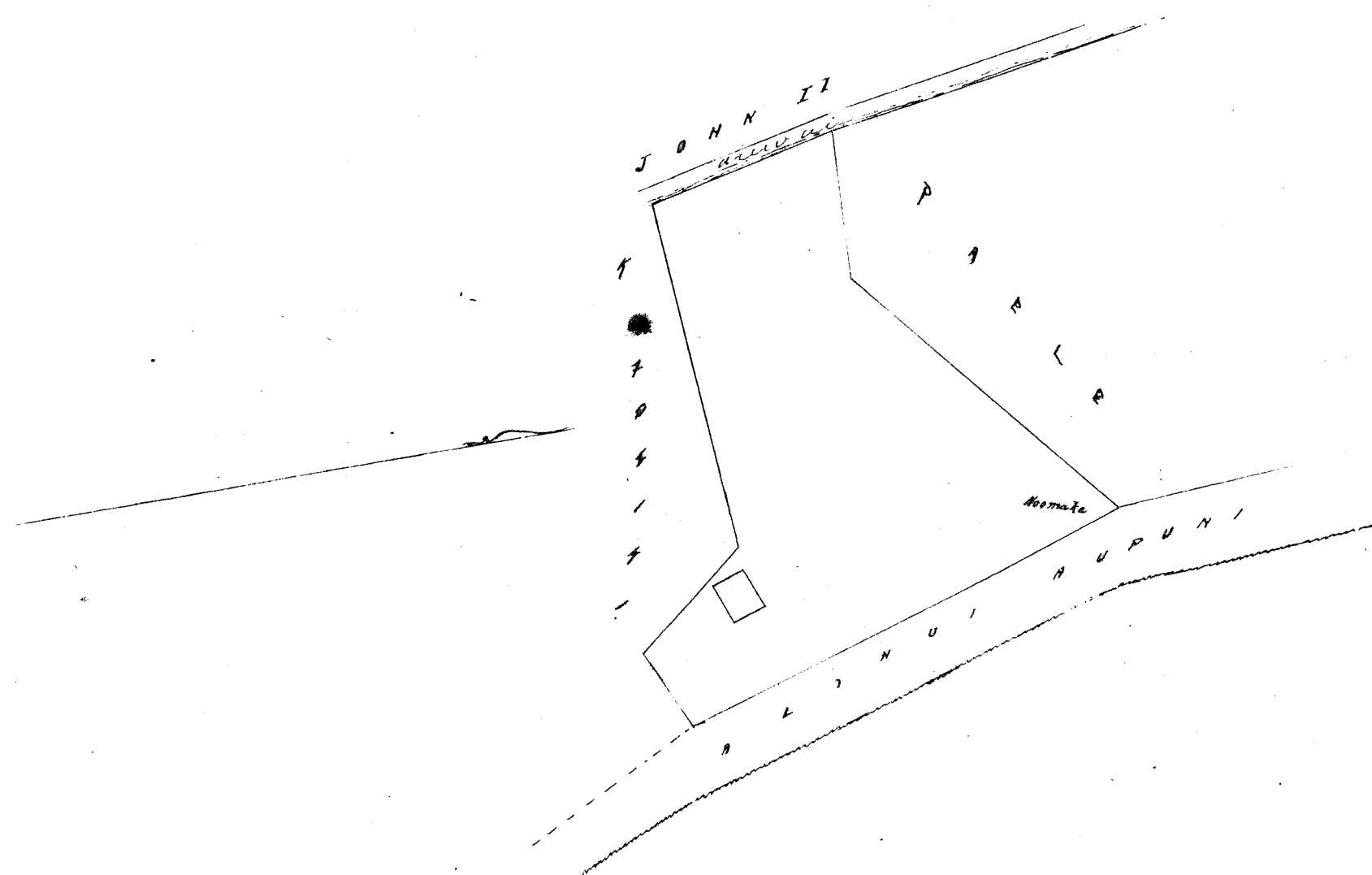

Helu 57 F.L. Kalua (no Kona)

Ua hoi mai oia no kona Apiana aiaa ma Kona i Honolulu, ma Kona, ma ke (Mokupuni) o Oahu, a like me na Kona aiaa o ke matakiki 1851, no ma aiaa Pawa, no ke mea, uua loa i wai keia wahi no Kona a me Kona mai i ke manawa o S. B. Kukini e noho Kona ana no Oahu me i ke matakiki 1853, a ua noho keakea oia a hiki i keia manawa.

Oia ka matakai e hooho nei no Kalua, ke kuleana hoi kona ma lalo iho o ke Aio Alodio. Ina e ukua mai oia i ke ke Aupuni hupaha, alaila, ua kupona i wai ke Palapala, Sila Alodio.

- Pono me i wai ke ukua me ke hooholo a me ke hooholo ana i ke olelo. Tenei,
- No ka oia a me ke pua ana i ke olelo ma ke Mupapa
- No ke kope ana i ke olelo Kona
- No ke palapala kii
- No ke huna ana i ke lawa 27 Aperila 1852. 16 o Mawaka 1852.
- No ke kope ana i ke olelo a me ke kope 1/2 Awa
- No ke ana ana i ke lawa 27. Aperila 1852. Uku i ke matakai
- No ke kope ana
- No ke hooholo ana i ke olelo i ke lawa 11 o Iulai 1853.

- W. L. Lee
- G. M. Robertson
- J. H. Smith
- J. Kekaulahao

	\$ Kona
3 00	

Kuleana ma Kona Kona Honolulu, Oahu.

4 Poi. E hoomaka ma ke kiki Hikiina o keia Kuleana, ma ke pohaku ma kiki e komo ai ke auwai i ke keia aiaa, a e holo i ke Akau 72 Kom. 56 Pautu, a me Akau 51 Kom. 80 Pautu ma ke auwai o ma Loi lili i ke Aupuni a hiki i ke lili Kona o ke auwai i wai o keia me Kona Kona no Kona Kona. Alaila kama 50 3/4 Kom.

192
 92 Poutu, a me Nenu 33° Kom. 72 Poutu ma ka hiki Nenu o iwa auwai a hiki i'ko M.D. Paalu, - Alaila Nenu
 50° 45' Hiki. 1 7/100 Kaulahas ma'ka Paalu, a hiki i'ka hiki auwai, - Alaila Nenu 28° 30' Hiki. 1 8/100 Kaulahas ma'ka
 hiki Akau o ka auwai iwana, keia me'ko Puiki a me'hololu a hiki i'ka hiki i'hoomaka'i.
 Eia Hoko o keia aina. 331 Anana.

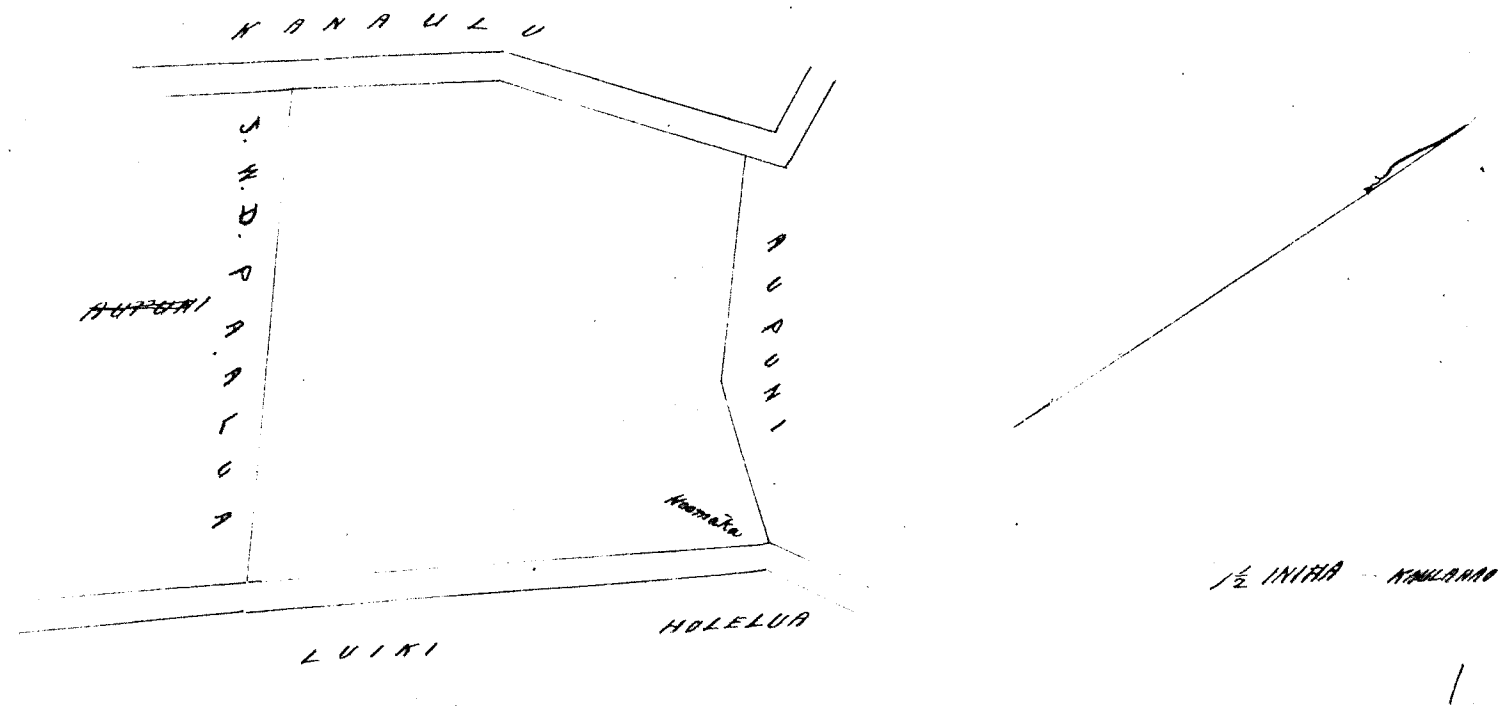

Heleu 59 FL. Kapinalua

Ua koi mai oia no kona Apama aiwa ma' Alawa i Honolulu, ma' Alawa, ma'ka Mokupuni o Oahu, e
 hiki me'wa Kanuawai o ka mukahiki 1851, no na aina Pahu; no ka mea, wa loa ia ia keia wahi no Kulekili, mai
 i'ka mukahiki 1850, a me'noho ke'kua oleia a hiki i'keia manawa.

Oia ku makou e hoko nei no Kapinalua, he kulekili hoi kona malalo i'ka Auu Alodia. Ima e ukua mai
 oia i'ko ke Aupuni hapaha, alaila, wa kupuna ia ia ka Palapala Sila Alodia.

- Iono mai ia ia ke ukua no ka hoo'oholo a me'ka hoo'oholo auu i'ka olelo. Penei, -
- No ka rami a me'ka fa'i ana i'ka olelo ma'ka Nupepa
 - No ke kope auu i'ka olelo koinu
 - No ke palapala kii
 - No ka huna ana i'ka la 16 o Mawaki 1852
 - No ke kope ma' i'ka olelo a wa hoi'ka, 1 awa.
 - No ke auu ana i'ka la 12 o Ima 1852. Ukuia ke ma' 46.
 - No ke kope ana
 - No ka hoo'oholo ana i'ka olelo i'ka la 11 o Iulai 1853.

W. L. Lee
 G. M. Robertson
 J. H. Smith
 A. K. Kaulahas

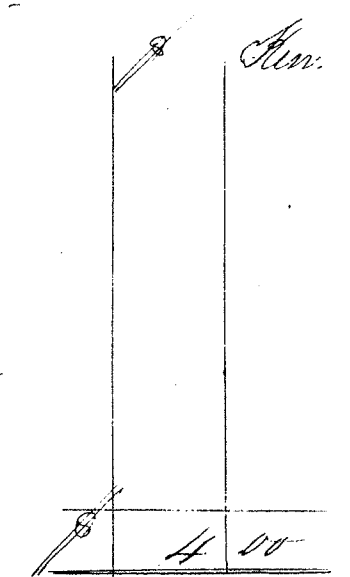

Eia ma' palawa. Anava e S.P. Kalamu.

Aina ma' Alawa Honolulu, Oahu.
 Oia a me'ka Iuku. E hoomaka ma'ka hiki Hikiina Nenu o keia Kulekili, e pili auu me'ko
 Aupuni, a me'ka Kulekili o Punalua i'ka auwa mai e Pomanu no ke Aupuni, - A e hoko i'ka Akau 44° Hiki. 1 44/100
 Kaulahas e pili auu me'ko Aupuni a hiki i'ko Imihia Kulekili, - Alaila hoko i'ka Akau 53° Kom. 2 Kaulahas a me
 Akau 35° Kom. 1 63/100 Kaulahas e pili auu me'ka Kulekili o Imihia a hiki i'ka x i'ho'ailonaiia ma'ka awa ma-
 loko o ka papohaku no ka aina, - Alaila Nenu 70° 30' Kom. 1 9/100 Kaulahas ma'ka papohaku i'olelo a hiki i'
 ke hiki Akau o ke Kulekili o Kulekili, - Alaila Nenu 40° Hiki. 2 7/100 Kaulahas ma'ia Kulekili a hiki
 i'ka papohaku i'ho'ailonaiia x ma'ka Hale Puna, e pili auu me'ka Apama aina o ke Aupuni i' munaia no
 Kanohiapuu, Alaila Nenu 45° 30' Hiki. 5 9/100 Kaulahas e iho ana me'ko Aupuni no Pomanu mai a hiki i'ka hiki
 i'hoomaka'i.

O Hoko o keia Kulekili Aina 9/100 Eka.

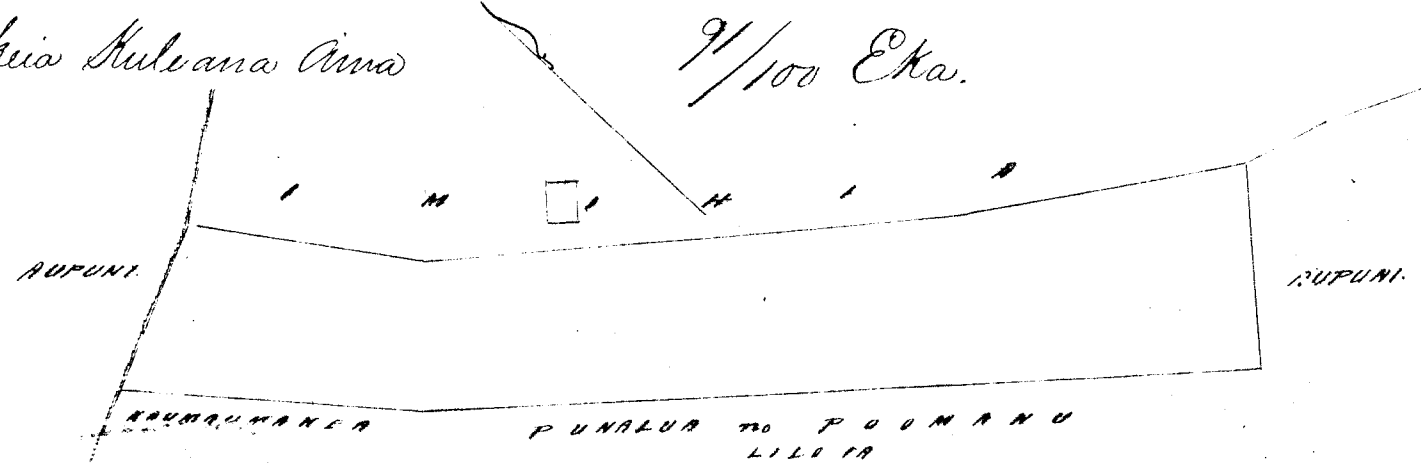

Heleu 70 FL Paete

Ua koi mai oia no kona Apana aia ma Puunui Ili i Honolulu, ma Kona, ma ka Motupuni, Oahu, a like me na Hanawai o ka makahiki 1851 no ma aiaa Papu; no ka mea, ua lona ia ia keia wahi no Kawahala mai i ka makahiki 1857, a ua moho keakea oleia a hiki i keia manawa.

Oia ka makou e hooke me i no Paete; he kuleana hoi kona malalo iho o ke Ano Alodio. Ina e uku mai oia i ke ke Aupuni hapaha; alaila, ua kupaia ia ia ka Palapala Sita Alodio.

Iono ma: ia ia ke uku no ka hooke hooke a me ka hooke ana i ka olelo. Penei:

W. L. Lee
G. M. Robertson
J. H. Smith
J. H. Kaulahao

No ka rumi a me ke paai ana i ka olelo ma ka Muepepa
No ka kope ana i ka olelo koina
No ka palapala hii
No ka hana ana i ka la 29 o Maraki 1852.
No ka kope ana i ma olelo a ma hoike 1/3 Awa
No ke ana ana i ka la 4 o Novemaba 1852. Ukuia ke ana \$6.
No ke kope ana i
No ka hooke ana i ka olelo i ka la 11 o Iulai 1853.

	\$	Ken.
	3	00

Oia ma palana

Anaia i S. P. Kalama

Ma Puunui Ili i Honolulu, Kona, Oahu.

Oia. E hoomaka ma ke hiki i Nihina mauka o keia aiaa e pili ana me Kahawai, a e holo Awa 5' Kom. 231 Panku e pili ana me Kalanikilo. Alaila Kona 82° 30' Kom. 1 1/2 Kaulahao, me Kona 65° 30' Kom. 112 Panku, a me Kona 24' Kom. 81 Panku e pili ana me Kahalelauhala. Alaila Kona 32° Nihina 2 1/2 Kaulahao me Kahawai no Samona a hiki i Kahawai. Alaila hooke ana ma Kahawai a hiki i ka hooke ana
Oia ka Ili 850 Anana

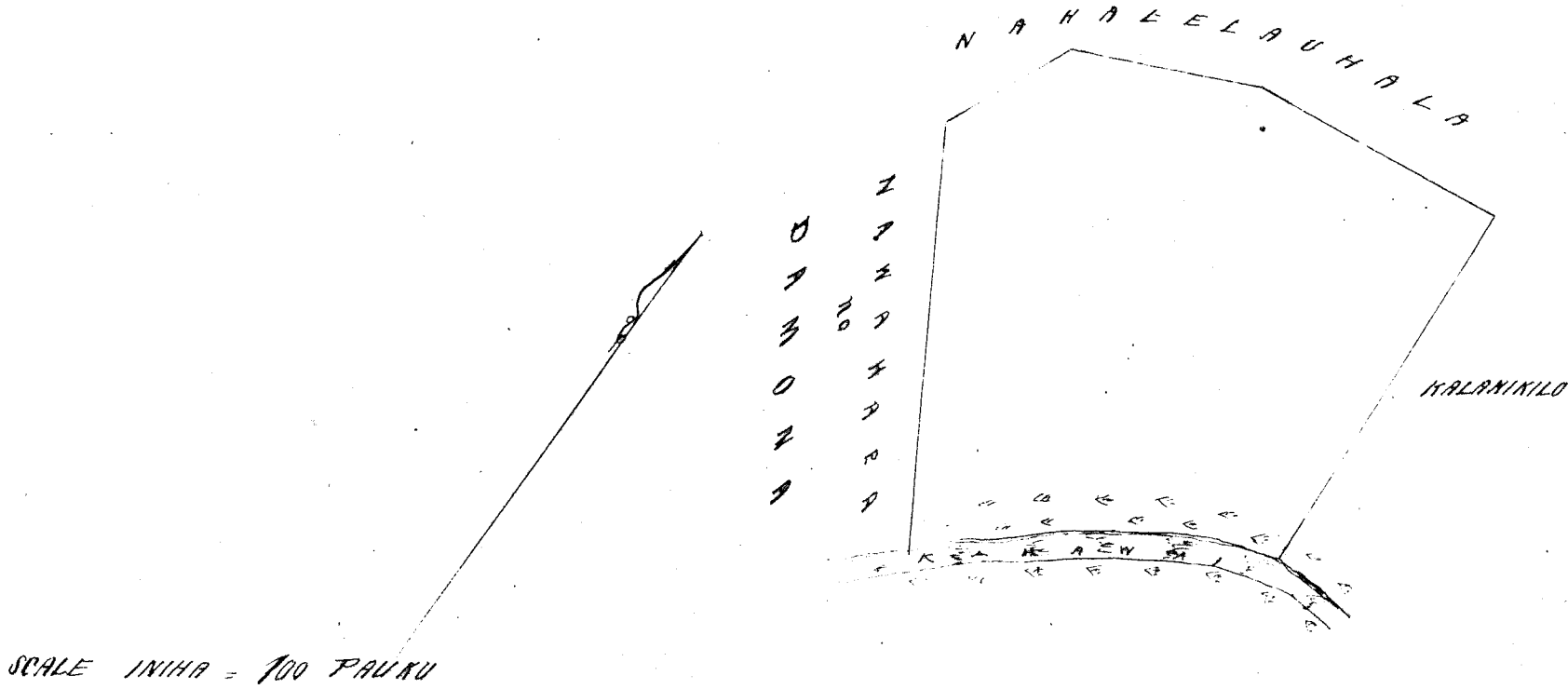

Heleu 76 FL Punohu

Ua koi mai oia no kona Apana Kahaukale ma Kuuwili i Honolulu, ma Kona, ma ka Motupuni o Oahu, a like me na Hanawai o ka makahiki 1851, no ma aiaa Papu; no ka mea, ua lona ia ia keia wahi no Hanamaia i ka makahiki 1838, a ua moho keakea oleia a hiki i keia manawa;

Oia ka makou e hooke me i no Punohu; he kuleana hoi kona malalo iho o ke Ano Alodio. Ina e uku mai oia i ke ke Aupuni hapaha; alaila, ua kupaia ia ia ka Palapala Sita Alodio.

Iono ma: ia ia ke uku no ka hooke hooke a me ka hooke ana i ka olelo. Penei:

W. L. Lee
G. M. Robertson
J. H. Smith
J. H. Kaulahao

No ka rumi a me ke paai ana i ka olelo ma ka Muepepa.
No ke kope ana i ka olelo koina
No ka palapala hii
No ka hana ana i ka la 29 o Maraki 1852
No ke kope ana i ma olelo a ma hoike 1/4 Awa
No ke ana ana i ka la 20 o Aperila 1852. Ukuia ke ana \$4.
No ke kope ana
No ka hooke ana i ka olelo i ka la 11 o Iulai 1853.

	\$	Ken.

Apama Kahuahale, ma Kuwili, Honolulu, Kona, Moku-puni Oahu.

E hoomaka ma ka pohaku paakea i hoailonaia x ma ke kiki Nihina mauka o keia Kahuahale, kokoke i ka Loko o ke Aupuni, "Kuwili" ka inoa, a e holo Nema 47° Kom. 2 haultahas a hiki i ke kiki Nema mauka o keia; a i ka Akau 43° Kom. 1 1/4 haultahas e pili ana kela mau arao me ke ke Aupuni a hiki i ke Kamaia Kahuahale, Alaila Akau 47° Sek. 2 haultahas ma ke Kamaia a hiki i ke hoailona x ma ka pohaku paakea kokoke i ka Loko o "Kuwili" ka inoa, - Alaila Nema 43° Nihina 1 1/4 haultahas ma ka arao mauka me ka palena ka Loko a puni keia Kahuahale ma kahi i hoomaka i.

Malike o ia Kahuahale He Kapaka Eka.

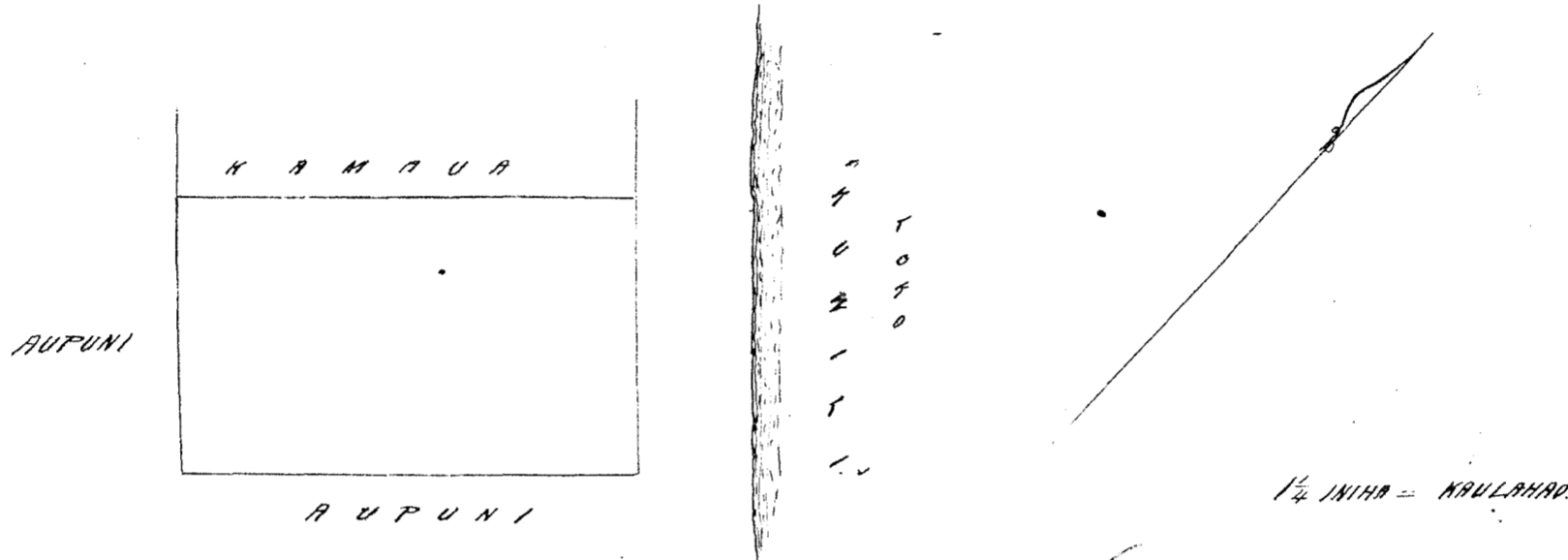

Sheet 78 FL G. D. Kuiaia

Ua koi mai oia no kona mau Apama aino ma Kapaekoa Honolulu, ma Kona, ma ka Moku-puni o Oahu, i ke me keia Kamaia o ka Makahiki 1851, no na aina Papa, ma ka mea, ma loa i ia keia mau wahi ma Kuiaia mai, kua makuakane i kua ma i wahi ai i ka makahiki 1837. He wahi nae i keia i hoopaapaa maia no ke koi ana mai o Alohi ke Kaitiamahine a Nihonui, ma ke kuleana o Nihonui kona makuakane, Aka, ma ka mau ana i ka olelo a ma hoike, ua maopopo no malaila ka oiaio.

Ma ka olelo a Kamaia ma hoike mau. Ua ike oia i keia wahi no Kuiaia o ka Kamaia ma mau pono o G. D. Kuiaia i ka wa no Poki i wahi ana imaua aku pahua ka makahiki 1829, ma Kakaia ka kama Konoheki i haawi mai, a ua oho olelo no a hiki i ka M. A. 1848, pau loa lakou i ka maku, ke ka mea koi o Nihonui, a me G. D. Kuiaia keiki a Kuiaia ma; ole oia i ike ma haawi lilo o Kamaia i keia kuleana ia Nihonui, ke noho wale iho no me Kamaia ma ma ke au makamaka.

Ma ka hoike a Kapaekoa, no Kuiaia ka makuakane o G. D. Kuiaia ka mea koi keia aino mai ka wa mau o Poki, a ua noho oia a hiki o Kamaia ka makuakane o G. D. Kuiaia ke kaitiamahine kua Kuiaia maku a hiki i kona manawa kokoke o maku, kauoha oia ia maia kua wahine a me Kamaia kona kaitiamahine a me G. D. Kuiaia kua keiki, Penei ma olelo. "E kua wahine a me kua kaitiamahine, e moho oia malaila o kua keiki o Kuiaia, a e malama oia i ka aino ma, a he kua wale no ka oia i ka aino ma." A make o Maia kua oia, kauoha oia e like me ke kauoha a kua kane. A makupe iho kokoke maku o Kamaia, kauoha oia ia Nihonui; penei, "E noho pu mai oe me au, a e malama i ka aino ma i hoi mai o Kuiaia Opiu, alaila ma ka kahi, a he noho wale iho no ka kua malama, paha ke kauoha a kona mau maku a paha no kua kauoha ia oe, e oho no oe maaua a hoi mai ia, a ina e kii mai kua i aku, oia kon loko e Kapaekoa Nihonui." Aka, ole i hoolehe o Nihonui i ke kauoha a Kamaia ka mea ma pono ke aino.

Ma ka hoike ana a Kapaekoa, Ua ike oia no Kuiaia keia aino mai ka wa o Poki mai a hiki i ka pau ana o kona mau maku i ka maku i ka M. A. 1848, ke ka mea koi me ka maia e loa ia ia ke kuleana o kona mau maku, a ke maia nei oia, ma kua kolhe wale no o Nihonui, a ke aino oia me ke Nihonui, a malaila oia i noho ai a kamaia loa, ole mau loa i hoohono i kuleana maia malaila. - A ua mau ma hoike ike pono; a ua like loa ka lakou hoike ana, e olelo ana, ua loa keia aino ia Kuiaia kona maia i ka wa o Poki; A maku ia, kauoha no i kua wahine a me kona kaitiamahine, no kua keiki no keia wahi; a me ke loa kauoha no o Kamaia ia Nihonui e malama i keia wahi no G. D. Kuiaia ke hiki i kona manawa e hoi mai ai mai Kapaekoa mai; aka, maku o Nihonui, koi mai o Alohi kua kaitiamahine ma keia wahi ma ka noho ana paha o kona makuakane alaila me ke kua aku i ka hoailona o Kuiaia.

Kolaita, wa maohope loa ia makou mai ka waha mai o na hoike ike pono, he kuleana ia ka mea koi, no ka mea ua loa i kona makua keia aina ma mua loa aku o ke kuu ana o na Hanawai, a wa noho oluolu oia a hiki i kona make ana i ka M.A. 1837, a hoo kama wahine a me kona kaikamahine ma keia wahi, - aole mea keakea. Ai ka make hope ana o Kamea hana makamahine o G.D. Kuiaia i ka M. A. 1848, ia manawa mahope iho, lilo ka hoo kuleana ana ia Nihonui. Kolaita wa make heua ke koi ana a Alahi ke kaikamahine a Nihonui, a he mea luki wale, a he hoolo paa nei makou, aole ona kuleana ma ka wahi, aole o ke makou Aha. A he hoo koi nei makou no G.D. Kuiaia ke koo ki a ma mea i make, a he kuleana hohonu hoi kona, e like me na Hanawai a e like hoi me ka mea i puka mai ka oiaio e hiki ai ia makou ke hoo holo e paa ai keia hoo paa ana.

Oia ka makou e hoo koi nei no G.D. Kuiaia; he kuleana hoi kona ma lalo iho, o ke Ano Alodio. Ima e uku mai oia i ke ke Aupuni hapaha; alaila, wa kupo no ia ia ka Palapala Sila Alodio.

Pono nae ia ia ke uku no ka hoo koi holo a me ka hoo holo ana i ka olelo. Penei

W. L. Lee
G. M. Robertson
J. H. Smith
J. Kikantaha

No ka wahi a me ke paa ana i ka olelo ma ka Muepepa
No ke kope ana i ka olelo kiina
No ka palapala hii
No ka kama ana i ka la 26 o Februari a me 29 o Maraki 1852.
No ke kope ana i na olelo a ma hoike 2 1/2 Awa
No ke ana ana i ka la 14 o Aperila 1852. Ukuia ke ana \$6.00
No ke kope ana
No ka hoo holo ana i ka olelo i ka la 11 o Iulai 1853.

	\$	Ken.
	\$	3 00

Oia ma palena. Anai e S. P. Kalama.

Aina ma Aiparaho, Honolulu, Oahu.

Apana 1. Poi me Kahuakale. E hoomaka ma ke hiki Nema ma ka o keia Apana aina, e pili ana me ke hiki Nihina ma ka o ka aina o Kamaka me ka auwai, a e holo Akaw 47° 30' Kom. 121 Pautu e pili ana me ke hiki Nihina a hiki i ke Aohopa, - Alaila Akaw 36° Kom. 176 Pautu e pili ana me Aohopa a hiki i ka auwai o Hanawai, - Alaila Akaw 32° Nihina 75 Pautu ma ka lili Nema oluna o ia auwai a hiki i ke hiki Komohana makai o Kamaka, - Alaila huli 204 Pautu ma ka lili o keia me Kamaka a hiki i ka hoomaka ana.

Oia ka Ili 244 Apana.

Apana 2. 5 Poi. E hoomaka ma ke hiki Nema makai o keia Apana aina, e pili ana me ke hiki Nihina ma ka o ka aina o Kamaka me ka auwai, a e holo Akaw 42° Kom. 267 Pautu pili me Kamaka, a me Akaw 15° Nihina 45 Pautu ma ka lili Nema oluna o ka auwai o Hanawai no Kame a hiki i ka palena o Kamakela, Alaila Akaw 44° Nihina 140 Pautu, a me Akaw 16° 30' Nihina 20 Pautu, a me Akaw 49° 30' Nihina 95 Pautu, a me Akaw 61° Nihina 50 Pautu, - a me Nema 62° Nihina 38 Pautu e pili ana me ka palena o Kamakela a hiki i ka Poi o Kamaka, - Alaila Nema 46° Nihina 81 Pautu, a me Akaw 35° 30' Nihina 25 Pautu pili me ka Poi o Kamaka, - Alaila Nema 44° Nihina 81 Pautu, - a me Nema 58° Nihina 59 Pautu pili me ke kuleana o Aina no Nihina a hiki i ka auwai o Apowale, - Alaila Nema 31° Kom. 51 Pautu ma ka lili Akaw o ia auwai a hiki i ke hiki Poi o Aina no Nihina, - Alaila Akaw 50° Kom. 156 Pautu, - a me Nema 45° Kom. 42 Pautu, a me Nema 56° Kom. 54 Pautu, - a me Nema 78° Kom. 30 Pautu, - a me Nema 56° Kom. 84 Pautu, - a me Nema 12° Kom. 34 Pautu, - a me Nema 45° Nihina 209 Pautu e pili ana me ke hiki Nihina a me Kamaka a hiki i ka auwai o Kamaui, - Alaila huli a e hoo holo i ka ma ka lili a hiki i ka hoomaka ana.

Oia ka Ili 829 1/2 Apana. Pau loa 1073 1/2 Apana.

(mao hii)

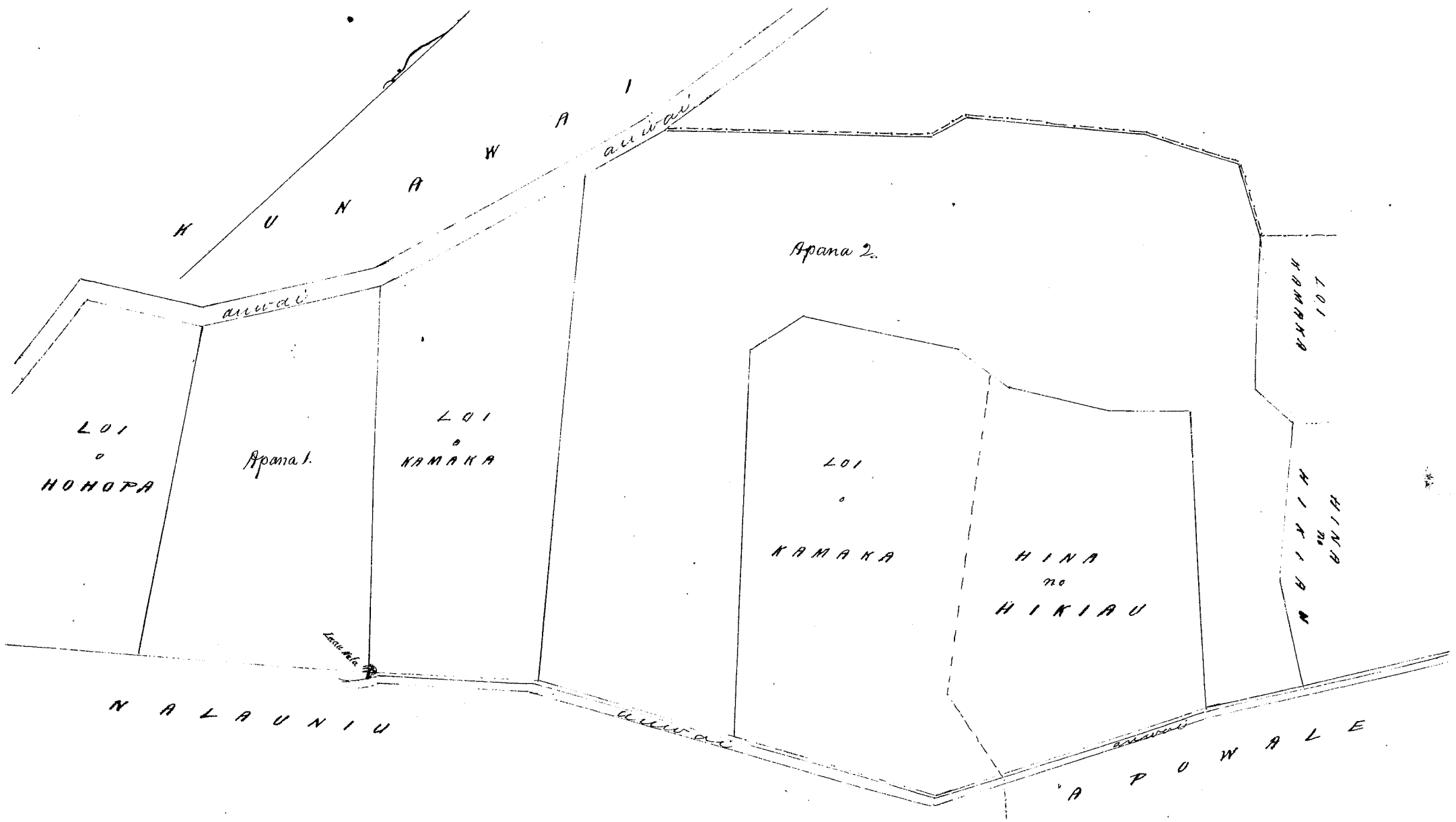

Hele 6792 Umi

Ua hoi mai oia no kona mau Apana aino ma ke Ahupuaa o Hauaula ma Pahaina, ma ke Motu-puni o Maui; no ka mea ua ho'oponopono i ka mau wahi no Cleave mai i ka manawa o Hoapili i ka Makaiki 1839, a ua noho keakea oleia a hiki i keia manawa.

Oia ka makou e hoohe me no Umi; he kuleana hoi kona malalo iho o ke Ano Alodio. Ina e uku mai oia i ke ke Ahupuaa; a iho, ua hoo'oponopono iho ka Palapala o ke Ano Alodio. I ka mau iho ke uku ma ke ke hoo'oponopono, a oia ka hoo'oponopono ma ke ke hoo'oponopono.

- N. L. Lee No ka kope ana i ka olelo kama
- G. M. Robertson No ka palapala kii
- J. H. Smith No ka hanaana i ka la 2. June 1849
- J. Kekaula No ke kope ana i ma olelo a ma hoohe 3/4 Awa
- No ke ana ana i ka la
- No ke kope ana
- No ka hoo'oponopono ana i ka olelo i ka la 15 o Iulai 1853.

Oia ma palena. Anaia e N. P. Alexander.

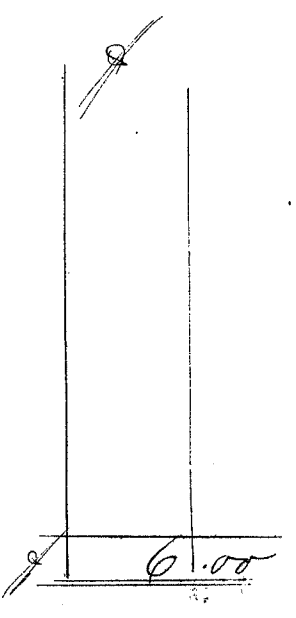

Aia kona aino kuleana ma ke Ali Kahuahina ma ke Ahupuaa o Pahaina Hauaula i Pahaina, Maui

Apana 1. E hoomaka ma ke kiki Hema, a holo aku

Akau 42' Hikiina	2.13	Akau i pili ana me Kahawai
Hema 89 1/4 Komohana	2.09	" " " ka pali
Akau 50 1/4 Komohana	5.00	" " " "
Hema 70 3/4 Komohana	2.14	" " " Kalua
Hema 55' Hikiina	4.67	" " " Kahawai
Hema 74 1/2 Hikiina	3.18	" " " i ka hoi i hoomaka ai.
Ka Ali	1 Eka 1 Ruda 3 6 Ruda	

Apana 2. Ma ke Ali o "Eleduli" kii. E hoomaka ana ma ke kiki Hikiina, a e holo ana

Hema 53' Komohana	2.56	Akau i pili ana me Kahawai
Hema 74 1/4 Komohana	0.59	" " " " Hekahiko
Akau 1 1/4 Komohana	0.99	" " " "

Kema	79°	Komohana	2, 53	Kaul. i pitu ana me	Kukahiho & Kalua
Akau	71 1/2°	Komohana	0, 62	"	" " Kaarao
Akau	82 1/2°	Hikina	2, 25	"	" " Kaanaana
Akau	23°	Hikina	1, 30	"	" " "
Akau	66°	Hikina	1, 77	"	" " ka pali
Kema	55°	Hikina	1, 85	"	" " " ikahi i'hoomaka ai.
Ka Iki	1 Ruda & 28 Ruda				

Apana 3. Ma ka Iki o "Hanaia" keia. E hoomaka ana ma ke kiki Akau Komohana a i holo ana
 Akau 85 1/4° Hikina 2, 10 Kaul. i pitu ana me Kaarao
 Kema 6 1/4° Komohana 1, 16 " " " " Kahuwai
 Akau 88° Komohana 1, 88 " " " " Pralima i'kaahi i'hoomaka ai.
 Akau 7° Komohana 0, 84 " " " " "
 Ka Iki 32 mau Ruda.

Apana 4. Ma ka Iki o "Maua" keia. E hoomaka ana i'kaahi Hikina a i holo ana
 Kema 69° Komohana 1, 39 Kaul. pitu me Kahanamoku
 Kema 83° Komohana 0, 64 " " " " Ukihi
 Kema 48 1/2° Komohana 1, 11 " " " " "
 Kema 84 1/2° Hikina 1, 60 " " " " Kahuwai
 Akau 42° Hikina 1, 75 " " " " " ikahi i'hoomaka ai.
 Ka Iki 24 Ruda.

1 E 1 P. 6 P.
 1 - 28
 32
 24
 2 E 0 . 10

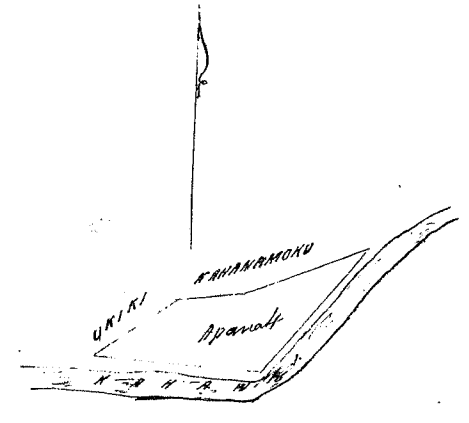

2 Kaula'ao = INIHA.

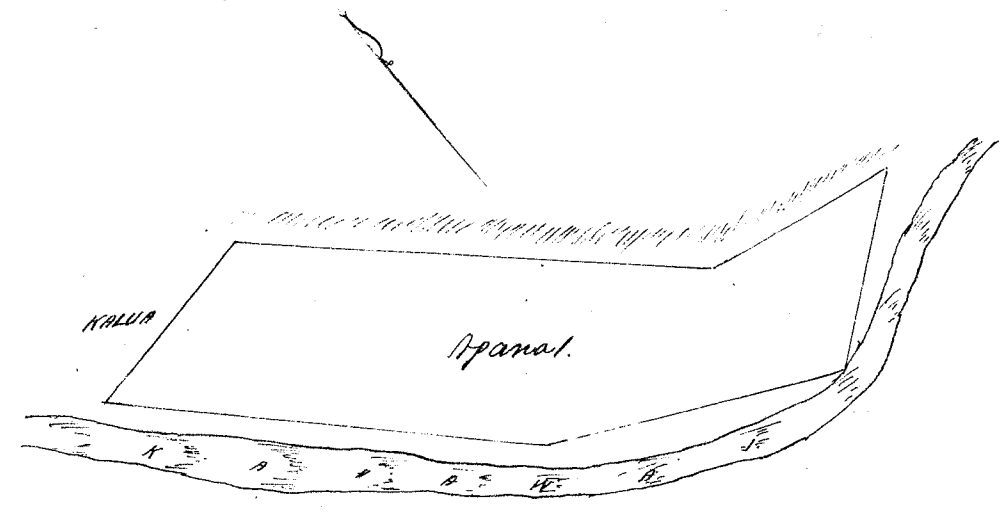

2 Kaula'ao = INIHA

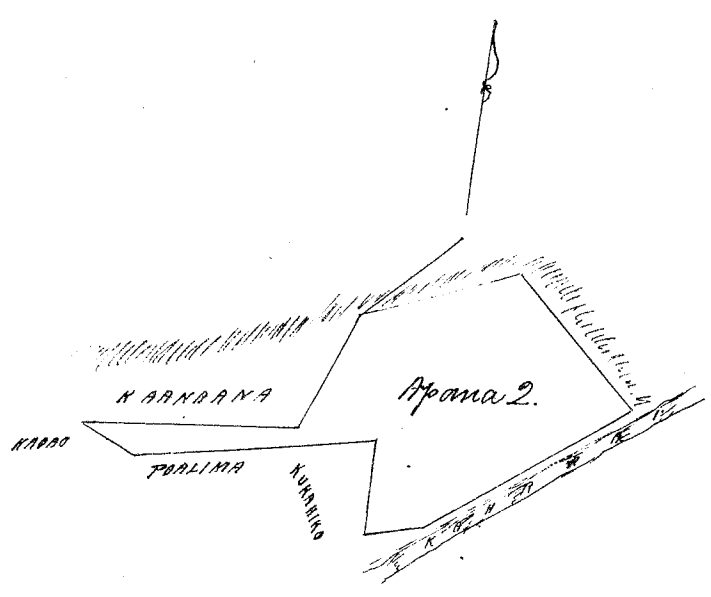

2 Kaula'ao = INIHA

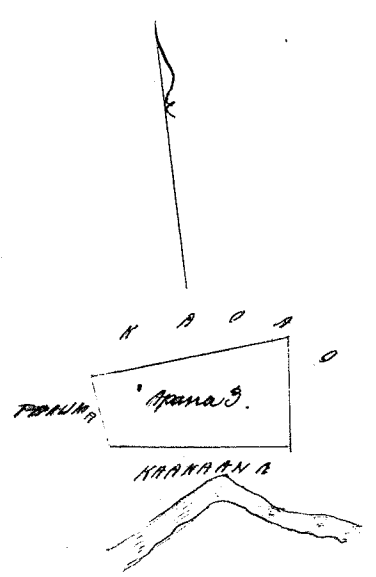

2 Kaula'ao = INIHA

Helu 6934 Ukiki (no ^{hoi} Naikaea)

Ua hoi mai oia no kona mau Apama Aina ma ke Ahupuaa o Kauaula, ma Lakaia, ma ka Mokupuni o Maui; ma ka mea, iwa hoia ia ia keia mau Apama Aina no. Hoi mai i ka makahiki 1839, a ua noho keakea oleia a hiki i keia manawa.

Oia ka makuahiko nei no Ukiki a ia Naikaea; ke kule ana hoi ma ke mata o ke Ana Alodis. Ina e uka mau oia i ke Aupuni hapaha; alaila, makupona ia ia ka Palapala Sitou Alodis.

Tono nae ia ia ke uka ma ka hookekeke a me ka hookekeke ana i ka olelo. Penei,

- W. L. Lee No ka rumi a me ke pahi ana i ka olelo ma ka Muepua
- G. M. Robertson No ke kope ana i ka olelo koina
- J. H. Smith No ka palapala kii
- J. Kekaulaha No ka hana ana i ka laka 6 o June 1849
- No ke kope ana i wa olelo a ma hoi ke 2/3 Airas
- No ka ana ana i ka laka
- No ke kope ana
- No ka hookekeke ana i ka olelo i ka laka 15 o Julai 1853.

\$	Ken.
\$	6 00

Eia ma palena. Anais e H. P. Alexander

Aia kona kuleana ma ke Ahupuaa o Kauaula, Lakaia, Maui.

Apama 1. Ma ka Ili o "Kuniamoe" keia. E hoomaka ana ma ke kikihi Kema Komohana, a e holo ana

Akau 57 1/2	Komohana	1.46	Akul.	e pili ana me Kahawai
Akau 50 1/2	Kikina	1.17	"	" " ka pali
Kema 89	Kikina	2.00	"	" " "
Kema 42	Komohana	2.14	"	" " Kahawa
Akau 61	Komohana	0.17	"	" " i kahi i hoomaka ai.

Ka Ili Hookahi Ruda.

Apama 2. Ke kule ma ka Ili o "Kauhiokalani". E hoomaka ana ma ke kikihi Kema Komohana a e holo ana

Akau 64	Kikina	4.68	Akul.	e pili ana me Kahawai
Akau 27 3/4	Komohana	0.91	"	" " Kalua
Kema 77	Komohana	2.52	"	" " ka pali
Kema 72	Komohana	2.80	"	" " "
Kema 87 1/4	Komohana	1.25	"	" " "
Kema 61 3/4	Kikina	3.00	"	" " Kahawai a hiki i kahi i hoomaka ai

Ka Ili 3 Ruda & 25 Roda.

Apama 3. Ma ka Ili o "Manoa". E hoomaka ana ma ke kikihi Kikina a e holo ana

Kema 64 3/4	Komohana	2.66	Akul.	e pili ana me (Umi
Akau 28	Komohana	0.34	"	" " Pipule
Akau 48 3/4	Kikina	1.34	"	" " Hanawaliwali
Akau 45 3/4	Komohana	2.19	"	" " "
Akau 36 1/2	Kikina	0.80	"	" " ka pali
Kema 49 3/4	Kikina	0.93	"	" " Poalima
Akau 86 1/4	Kikina	0.18	"	" " "
Kema 31 1/2	Kikina	1.11	"	" " & Kalua
Akau 49	Kikina	0.28	"	" " Kalua
Kema 59 1/4	Kikina	1.27	"	" " Kahawanoohe i kahi i hoomaka ai.

Ka Ili Hookahi Ruda & 16 Roda

Apama 4. Ke kule wala me ke Kapiki keia ma ka Ili o "Alamiki". E hoomaka ana i ke kikihi Kema Kikina a e holo ana

Akau 83 1/4	Komohana	1.14	Akul.	e pili ana me Hanawaliwali
Akau 4	Komohana	4.63	"	" " Komohiki
Kema 87	Kikina	1.40	"	" " Pali

Kema 2 1/4 Sikiina 4, 67 Kaul. e pili ana me Komohana i kahi i hoomaka ai.
 Ka Ili 2 Roda o 13 Roda

Kema 5. He mala uala kahiki keia, aia mauka loa o Kauaula, e waiho ana malama o ka pali pono ole ke ana.

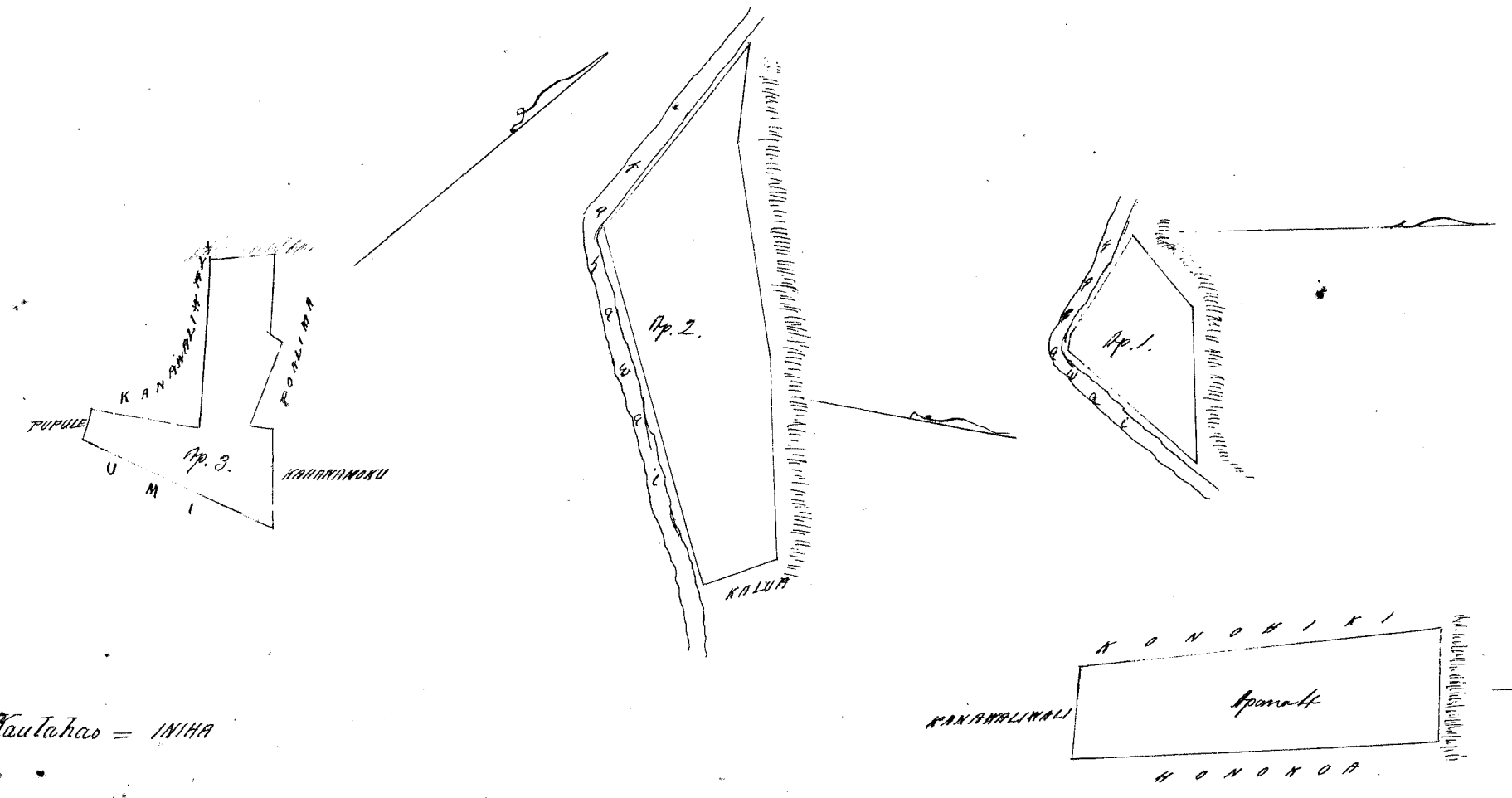

1 R
 3-25
 1-16
 2-13
 2 E. 0. 14

2 Kaulahas = INIHA

Helu 6883 Kaharamoku

Uwahi mai oia no kona mau Apama aino me ke Ahupuaa o Kauaula me Lahaina, ma ka Moku o Maui; no ke mea, ua loa ia ia keia mau wahi no Kewalo mai i ka makahiki 1840, a ua noho kakaia oia i keia manawa.

Oia ka makou, a hoko nei no Kaharamoku; ke kuleana hoi kona malalo iho o ke Ano Aloha. Ina e ukui mai oia i ke ke Ahupuaa kakaia, alaila, ua kupaia ia ia ka Palapala Sila Aloha.

Ua mau ia ia ke ukui no ka hoholo a me ka hoholo ana i ka olelo. Puni.

- H. L. Lee No ke ukui a me ke pili ana i ka olelo me ka Kupaia
- G. M. Robertson No ke kupaia ana i ka olelo kona
- J. H. Smith No ka palapala kii
- J. H. Smith No ke hana ana i ka la 4 o Iune 1849.
- J. H. Smith No ke kupaia ana i ka olelo a na hoike 12
- J. H. Smith No ke hana ana i ka la 15 o Iulai 1853.

Oia na pulewa Ina e W. P. Alexander

Aia ma ke Ahupuaa o Kauaula i Lahaina. Maui, keia kuleana.

Kema 1.	Maka Ili o Kama'i kii.	E hoomaka ana i ke kahi Komohana, a e holo ana
Akau 61 3/4	Sikiina	1.78 Kaul. e pili ana me Kalama
Kema 31 1/4	Sikiina	1.49 " " " "
Kema 69	Komohana	1.39 " " " Umi
Akau 23 1/2	Komohana	0.14 " " " Ukihi
Akau 50 1/2	Komohana	1.27 " " " " i kahi i hoomaka ai
Ka Ili	34 Roda.	

Kema 2.	E hoomaka ana i ke kahi Akau Komohana, a e holo ana	
Akau 72	Sikiina	2.40 Kaul. e pili ana me Kalua
Kema 16 1/4	Sikiina	1.60 " " " Kaamaana
Kema 68 3/4	Komohana	2.38 " " " "

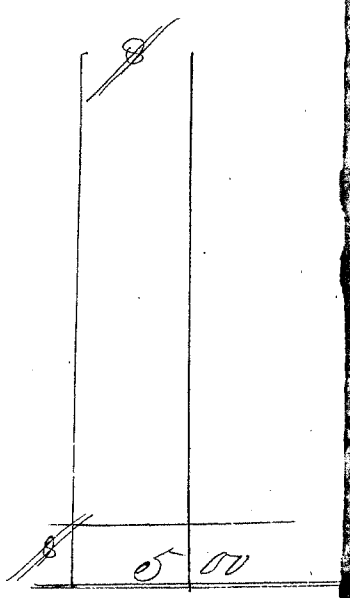

Maui 18 3/4 Komohana 1.73 Haul. e pili ana me Paepoe i kahi i hoomaka ai
 Ka Ali 1 Ruda & 23 Roda.

Apana 3. E hoomaka ana ma ke kahi Heema Hikina, a e holo ana
 Akau 8 1/4 Komohana 1.54 Haul. e pili ana me Kalua
 Heema 65 Komohana 1.93 " " " " Kahawai
 Heema 20 1/4 Hikina 0.68 " " " " "
 Akau 86 Hikina 1.71 " " " " ka pili i kahi i hoomaka ai.
 Ka Ali 32 Roda

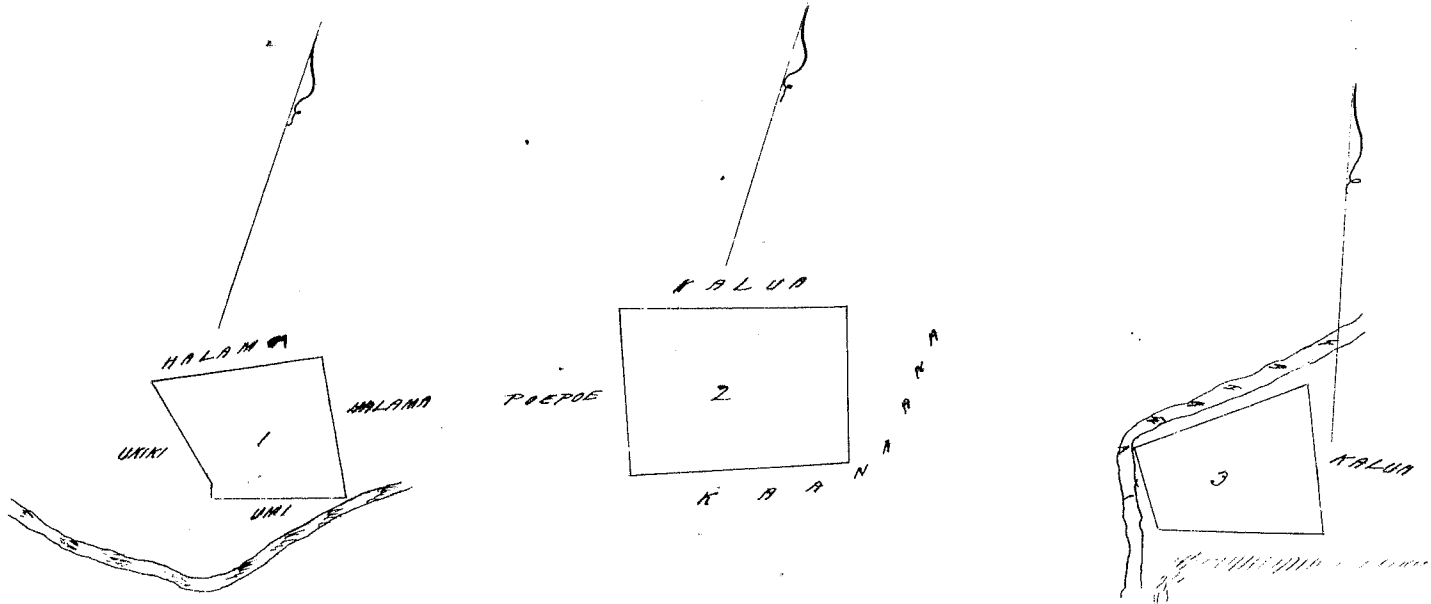

2 Kaulahao = NIHA.

Helu 4878 L. Honokoa

Ua koi mai oia no kona mau Apana Aina mau na Ahupuaa o Kalakoa a me Hauaula mau
 Lapauna, ma ka Mokupuni o Maui, no ka mea, i a hooa i a i keia mau wahi no Hauaihae mai i ka
 makahiki 1839 kela mau Apana mau Hauaula mai, a ua hooa hoi ka Apana ma Kalakoa no Hauaula mai i ka
 wa o Hoapili mamua aku o ka makahiki 1839, a ua hooa hooa oleia a hiki i keia manawa.

Oia ka makou e hooa mai no Honokoa, ke kuleana hoi kona malalo iho o ke Aho Alodio. Ima e hooa
 mai oia i ke Aupuni hapaha; alaila ua kupoia i a i ka Palapala Lita Alodio.

- | | |
|-----------------|---|
| W. L. Lee | No ka wahi a me ke pili ana i ka olelo ma ka Nupupa |
| G. M. Robertson | No ke kope ana i ka olelo kii |
| J. H. Smith | No ka hana ana i ka la 1 o Iune 1849 |
| J. Kaulahao | No ke kope ana i ma olelo a ma hoi ke / Aho |
| | No ke ana ana i ka la |
| | No ke kope ana |
| | No ka hooa hooa ana i ka olelo i ka la 15 o Iulai 1853. |

	8	00
--	---	----

Oia na palena. Aina e J. P. Alexander

Aia kona mau Apana aina kuleana ke wahi la ma na Ahupuaa o Kalakoa a me Hauaula i Lapauna ma
 Maui.

Apana 1. Ma Kalakoa i ka Tahale. E hoomaka ana ma ke kahi Heema Komohana, a e holo ana
 Akau 10 1/2 Komohana 0.71 Haul. e pili ana me Mamaka
 Akau 72 Hikina 1.56 " " " " Aia
 Heema 51 1/4 Hikina 1.46 " " " " Mamaka & Aupuni
 Heema 63 1/4 Komohana 4.82 " " " " Kupihua
 Akau 42 Komohana 0.73 " " " " Alamii hou o ke Aupuni
 Akau 61 1/4 Hikina 2.17 " " " " Mamaka i kahi i hoomaka ai
 Ka Ali 1 Ruda & 30 Roda.

Apana 2. Aia ma Hauaula keia, Ua kapaia keia kuleana "Manoa". E hoomaka ana ma ke kahi Akau Hikina
 a e holo ana

Hema 45°	Komohana	1.40	Kaul.	E pili ana me Kalama
Akau 42 1/4	Komohana	1.71	"	" " " "
Akau 53 1/2	Komohana	0.44	"	" " " "
Hema 66 1/4	Komohana	0.29	"	" " " "
Akau 39 3/4	Komohana	0.47	"	" " " "
Akau 52 1/2	Hikina	1.91	"	" " " kaipali
Hema 36 1/4	Hikina	1.33	"	" " " Kalama
Akau 81°	Hikina	0.24	"	" " " "
Hema 36 3/4	Hikina	0.67	"	" " " "
Hema 29°	Komohana	0.21	"	" " " "
Hema 46°	Hikina	0.38	"	" " " i kahi i hoomaka ai.

Ka Ii

1 Ruda & 26 Roda

Apana 3

Ma Nauaula no, ma ka Ii. "Kaukiokalani." E hoomaka ana ma ke kahi Hema Hikina a e holo ana

Akau 36 1/2	Komohana	3.10	Kaul.	E pili ana me Kahawai
Hema 72 3/4	Komohana	3.47	"	" " " "
Hema 71 1/2	Hikina	5.18	"	" " " kaipali i kahi i hoomaka ai.

Hookahi hapalua Eka.

Ka Ii

Apana 4.

Ma Nauaula ma ka Ii. "Kamaia." E hoomaka ana ma ke kahi Hema Hikina, a e holo ana

Akau 18 1/2	Hikina	0.48	Kaul.	E pili ana me Kaaruaana
Akau 16°	Komohana	0.50	"	" " " "
Akau 65°	Komohana	0.62	"	" " " "
Hema 39 1/4	Komohana	0.26	"	" " " Kukahiko
Hema 59 1/4	Komohana	1.35	"	" " " "
Hema 60 1/2	Hikina	1.30	"	" " " Kahawai
Akau 70 1/2	Hikina	0.73	"	" " " i kahi i hoomaka ai.

27 Mau Roda

Ka Ii

Apana 5.

Ma Nauaula no. E hoomaka ana ma ke kahi Hema Hikina, a e holo ana

Hema 89 1/2	Komohana	7.69	Kaul.	E pili ana me Kahawai
Akau 23°	Hikina	1.77	"	" " " Kawai - Ma huina i ka pili 30° Degere
Akau 6 3/4	Hikina	4.79	"	" " " " " " 20° "
Hema 82 3/4	Hikina	5.53	"	" " " kaipali " " " 20° "
Hema 20°	Komohana	1.77	"	" " " Kaialau " " " 20° "
Hema 47°	Hikina	2.59	"	" " " " " " 20° "
Hema 5 1/2	Hikina	0.87	"	" " " " " " "
Hema 79 1/4	Komohana	0.50	"	" " " " " " "
Hema 5°	Hikina	0.94	"	" " " Kaiaholohai i kahi i hoomaka ai.

3 Eka 2 Ruda & 30 Roda

Ka Ii

Olelohoakaka. Eia keia mau hoakaka. Hookahi Apana kuleana. Hono koa i ke, he kihapai wala kahiki, aia ma uka loa o Nauaula, a pono ole ke kii aku e ana, aka, ea, nona is no ia kihapai.

R. 30
1-26
2
27
30
4532-3

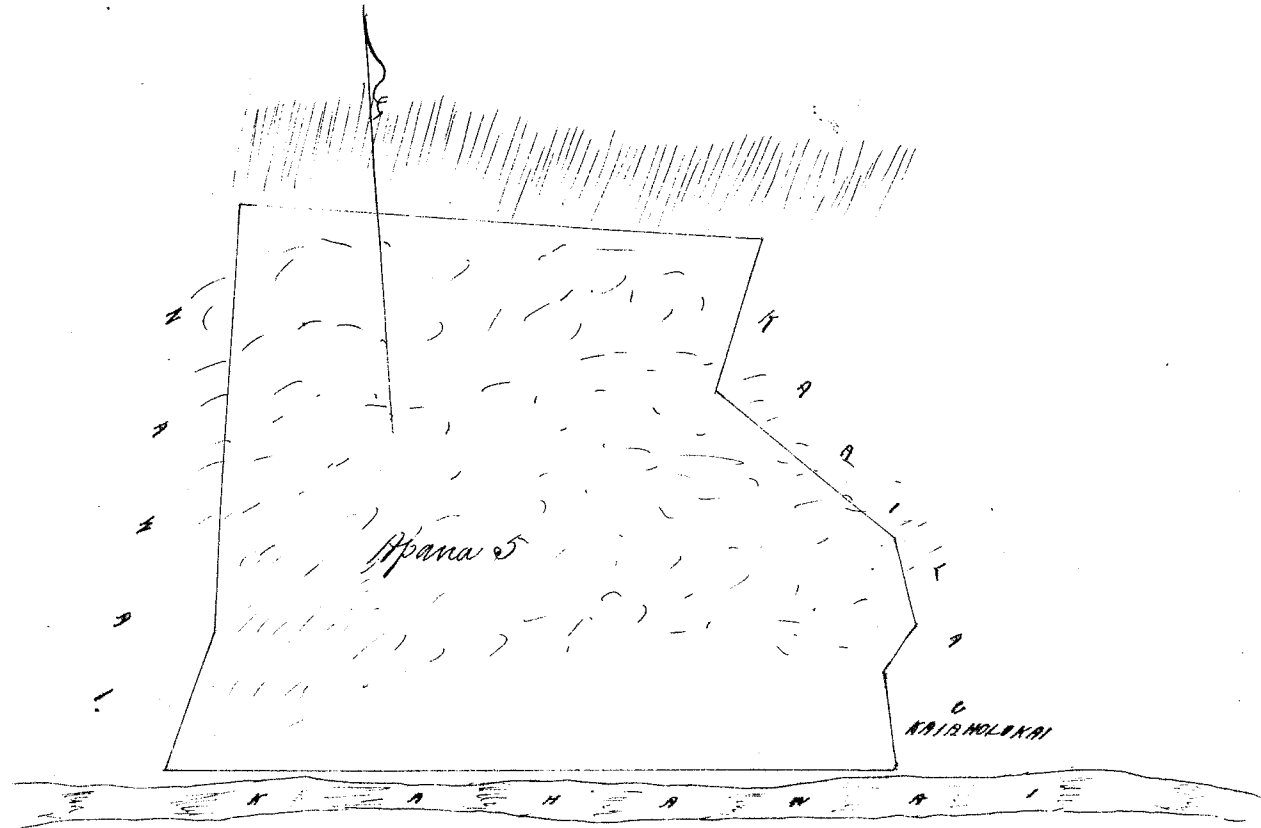

2 Kaulaao = 1MHA.

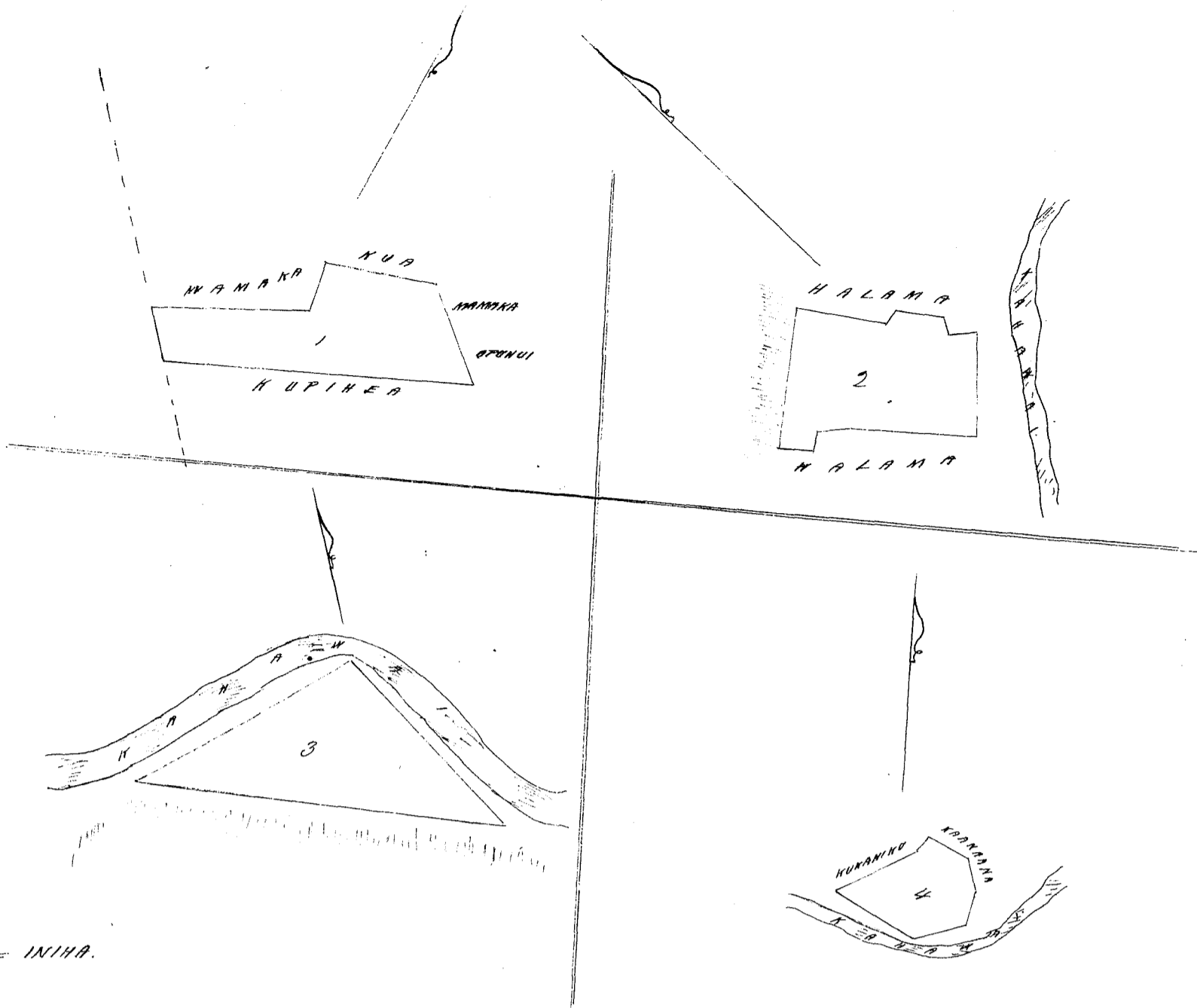

2 Kaula hae = 1/4 HA.

Helu 6867 Toepoe

Ue koi mai oia no kona wahi Apama aina ma ka Ali o Hanapa a me Alamiki ma ke Ahupuaa o Kaula ma Labaina ma ka Mokupuni o Maui, ma ka mea, ua lona iaria keia mau wahi no Keawe mai i ka manawa o Hoapili, a ua noho keakea oleia a hiki i keia manawa.

Oia ke makuu e hoole nei no Toepoe; ke kuleana koi kona matato iho o ke Aho Alodio. Ina e ukua mai oia i ke ke Aupuni hapaha; aiaia, ua kupo iaria ke Palapala Lita Alodio.

Pono mau ia ia ke ukua ma ka hooholo holo a me ka hooholo ana i ke olelo. Poni;

W. L. Lee
G. M. Robertson
J. H. Smith
J. Kekaulaha

No ka umu a me ke pua ma i ke olelo ma ka Napoona.
No ke kope ana i ke olelo koina
No ka hana ana i ke olelo 11 o Iune 1849.
No ke kope ana i ke olelo a ma hoike hana
No ke ana ana i ke olelo
No ke kope ana
No ka hooholo ana i ke olelo i ke olelo 15 o Iulai 1853.

\$	Ten.
5	00

Eia ma pakuu.

Anaia o W. P. Alexander

He wahi kuleana kona e wahi ana ma ka lona o ke Ahupuaa o Kaula, ma Labaina, Maui.

Apama 1. Ma ka Ali o "Hanapa." E hoomaka ana ma ke kahi Akau (Kikina), a e holo ana

Hema 23° Komohana	1.14	Kaul. e pili ana me Kaula
Hema 51 1/2° Komohana	1.21	" " " "
Hema 56° Komohana	1.21	" " " "
Akau	0.70	" " " "
Akau 53 3/4° Kikina	2.94	" " " ka Pali i kahi i hoomaka ai.
Ma Ali 24 Mau Roda.		

Apama 2. Ma ka Ali o Alamiki keia. E hoomaka ana ma ke kahi Komohana, a e holo ana

Hema 35° Kikina	0.85	Kaul. e pili ana me Kaula
Akau 72° Kikina	2.52	" " " " Kaula
Hema 69° Kikina	1.58	" " " "
Akau 35 3/4° Kikina	0.56	" " " " Kaula

Akau 21 1/2 Komohana 1.67 Kaul. e pili ana me Poulina o Kalua
 Akau 67. Hikina 2.27 " " " " " "
 Akau 18 3/4 Komohana 2.48 " " " " " "
 Kema 61 1/2 Komohana 5.21 " " " " " "
 Kema 17 1/2 Komohana 2.42 " " " " " "
 Ka Iki Kookahi Eka 3 3 Roda.

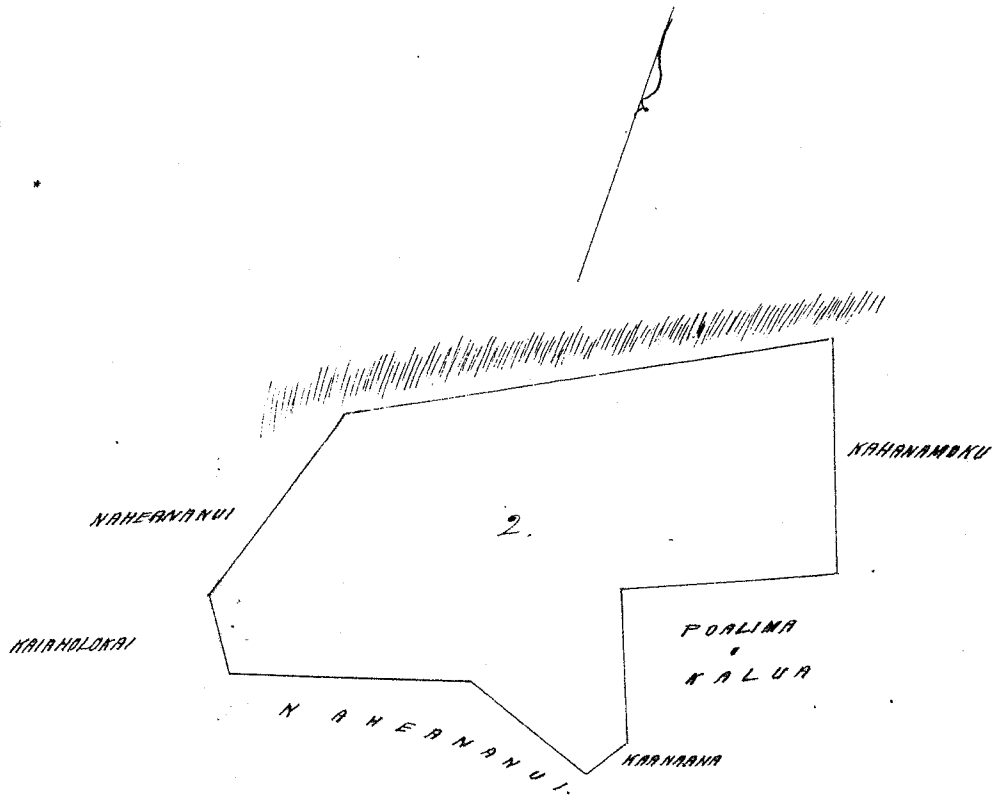
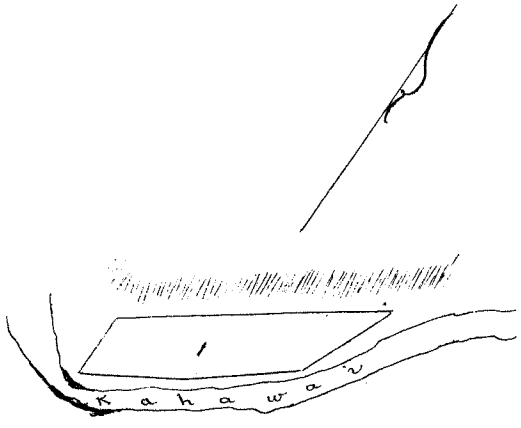

2 Kaulahas = Ikiha.

Helu 6869 Kawaiiohu Ikiha 1859

Ua hiki mai oia no kona Apama aino ma ke Ahupuaa o Makaha ma Lahaina, ma ka Mokupuni o Maui no ka mea, ua loaa iu iu keia wahi no Koa-pili mai, a ua mahe keakea oleia a hiki i keia manawa.

Oia ka mukou e hooke me no Kawaiiohu, he kuleana hoi konu matalo iho o ke Auo Aloha. Ina e uku mai oia iho ke Ahupuaa hapaha; alaila, ua hooke ia iu ka Palapala Sila Aloha.

Pono nana ia iu ke uku no ka hooke olelo a me ka hooke ana i ka olelo. Puni,

- | | |
|-----------------|--|
| W. L. Lee | No ka rumi a me ke pua'ana i ka olelo ma ka Ahupuaa. |
| G. M. Robertson | No ke kope ana i ka olelo kama |
| O. H. Smith | No ka hana ana i ka ka 4 o ^{June} October 1859 |
| J. Kikunahau | No ke kope ana i ka olelo a ma hiki 1/2 Aua. |
| | No ke ana ana i ka ka |
| | No ka kope ana |
| | No ka hooke ana i ka olelo i ka ka 15 o Iulai 1853. |

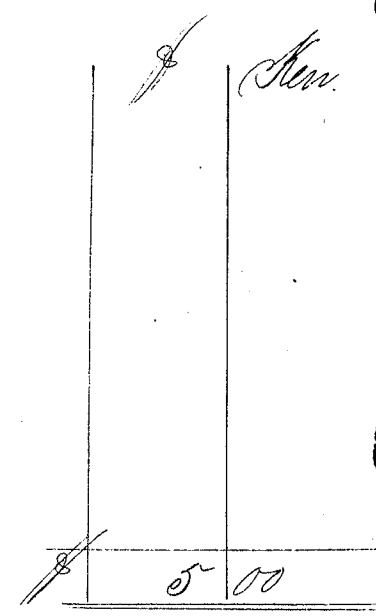

Eia ma palana.

Anaia e H. P. Alexander

Apama 3. He Apama aino kuleana ana i ka, he kuleana, oia ma ma ke Ahupuaa o Makaha i Lahaina Maui. He pili pua'ana me kekahi Apama aino kato i anaia nana mianua, a ua hooke ia mai no hoi.

E hoomaka ana ma ke hiki Kema Komohana, a e holo ana.

Akau 6 Komohana 0.64 Kaul. e pili ana me Poulina
 Akau 71 1/2 Hikina 0.30 " " " "
 Akau 11 1/2 Komohana 0.53 " " " "
 Akau 86 3/4 Komohana 0.27 " " " "
 Akau 4 1/4 Komohana 4.89 " " " "
 Akau 50 1/4 Hikina 4.90 " " " " ka pali
 Kema 7 Hikina 6.34 " " " " " "
 Kema 57 Komohana 2.81 " " " " " "
 Kema 18 3/4 Hikina 0.68 " " " " " "
 Kema 79 Komohana 1.92 " " " " " "
 Ka Iki 2 Eka 3 Roda 5 7 Roda.

He mea hookeka. Eia iloko o keia kekahi Poulina o Hanaina (he 20 Roda ka ili) a ua hooke ia mai Hanaina ia Kawaiiohu i hooke iloko o kona kuleana. H. P. A.

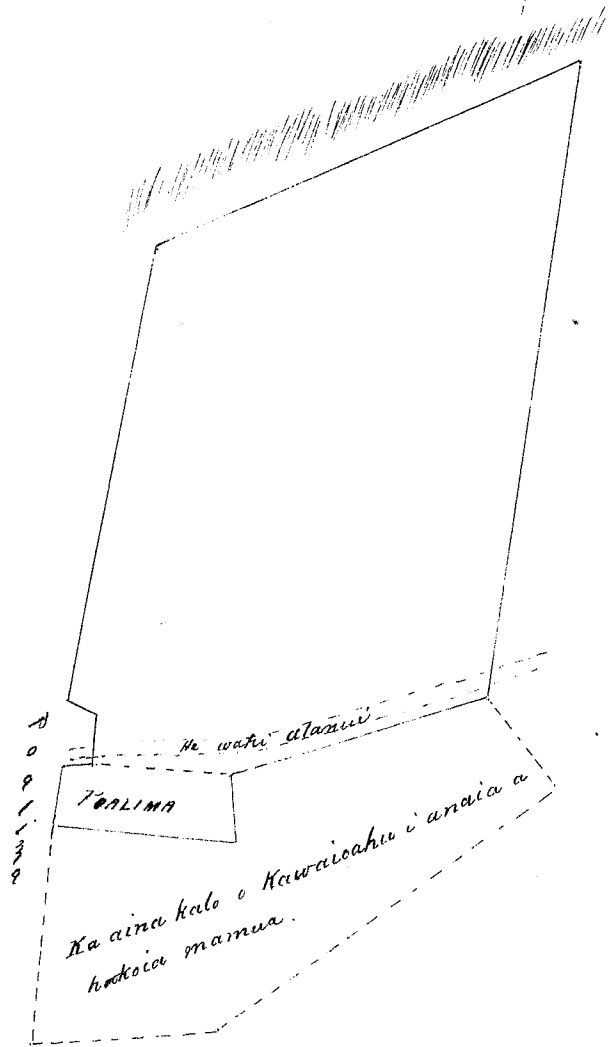

2 Kaulahao = 101117

Helu 9823 Kawa

Ua koi mai oia me kona mau Apua aina maika Ali o "Kamaia", ma ke Ahupuaa o Kawaia, ma Lahaina, ma ke Moku o Maui, no ka mea, ua loaia i ia keia mau wahi no Kewalo mai i ka Makahiki 1846, a ua noho keakea oia a hiki i keia mau mau.

Oia ka makou e hoko mai no Kawa, ke kuleana hoi kona malalo iho o ke Aho Aloha. Ima e uku mai oia i ke ke Ahupuaa hapaha, alaila, ua kupaia ia i ka Palapala Sila Aloha.

Pono naia ia ke uku no ka hoholo a me ka hoholo ana i ka olelo. Puni.

W. L. Lee
G. M. Robertson
J. H. Smith
J. Kaulahao

No ka rumi a me ke pua ana i ka olelo ma ke Aho Aloha
No ke kope ana i ka olelo hoiina
No ka palapala hoi
No ka hana ana i ka la 6 o Iune 1849.
No ke kope ana i na olelo a ma hoi ke 13 Aho
No ke ana ana i ka la
No ka kope ana
No ka hoholo ana i ka olelo i ka la 15 o Iulai 1853.

	Ken.
	6 00

Eia na palama.

Aiaia i St. P. Alexander

Ke aina kuleana kona ma ke Ahupuaa o Kawaia, ma Lahaina, Maui.
Apua. Aia ma ka Ali o "Kamaia". E hoomaka ana ma ke hiki Akau Hikina, a e holo ana

Akau	85 1/2	Komohana	1.46	Kaul. e pili ana me Kaula Umi
Kema	9	Hikina	1.68	Kaula
Akau	87 1/2	Komohana	0.23	"
Akau	5 1/2	Komohana	0.59	"
Akau	83	Komohana	0.33	"
Akau	46 3/4	Komohana	1.55	"
Kema	88 1/4	Komohana	5.69	ka pali
Kema	56 1/2	Hikina	0.38	Kaula
Kema	87	Hikina	0.86	Kaamaana
Akau	85 1/4	Hikina	2.10	Umi
Kema	6 1/4	Komohana	1.16	"
Kema	47 3/4	Hikina	0.53	Kahawai
Akau	22 1/4	Hikina	0.50	Koku

Keema	78 3/4	Hikina	1.33	Kaul. v pili ana me Moku
Keema	18 1/4	Hikina	1.17	" " " "
Keema	85	Hikina	2.10	" " " Pali
Mau	77	Hikina	1.75	" " " "
Mau	19 1/2	Hikina	1.45	" " " Hukuhiko
Mau	10	Komohana	1.18	" " " Palina i kahi i'hoonaka ai.

Keema 2.

Keema 80° Hikina 3.40 Kaul. v pili ana me ka Pali

Keema 86 3/4 Hikina 2.62 " " " " a i'kela ana o kahi awa

Keema 27° Komohana 3.24 " " " " Hukuhiko

Keema 80 3/4 Komohana 0.94 " " " " Palina

Keema 10 1/2 Hikina 0.61 " " " "

Mau 85 3/4 Komohana 0.60 " " " Kaulau

Mau 10 1/4 Komohana 0.54 " " " "

Keema 75 1/4 Komohana 1.80 " " " "

Mau 47° Komohana 2.43 " " " Hukuhiko

Mau 20° Hikina 1.66 " " " i'kahi i'hoonaka ai

Keema 2.

Keema 80° Hikina 3.40 Kaul. v pili ana me ka Pali

Keema 86 3/4 Hikina 2.62 " " " " a i'kela ana o kahi awa

Keema 27° Komohana 3.24 " " " " Hukuhiko

Keema 80 3/4 Komohana 0.94 " " " " Palina

Keema 10 1/2 Hikina 0.61 " " " "

Mau 85 3/4 Komohana 0.60 " " " Kaulau

Mau 10 1/4 Komohana 0.54 " " " "

Keema 75 1/4 Komohana 1.80 " " " "

Mau 47° Komohana 2.43 " " " Hukuhiko

Mau 20° Hikina 1.66 " " " i'kahi i'hoonaka ai

1.023
1.2.30
2.3.18

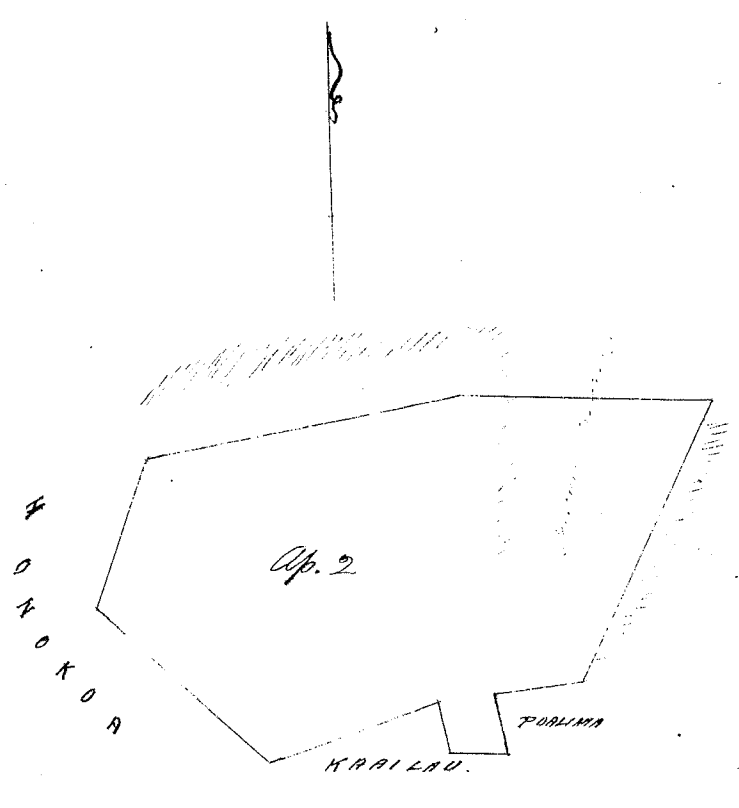
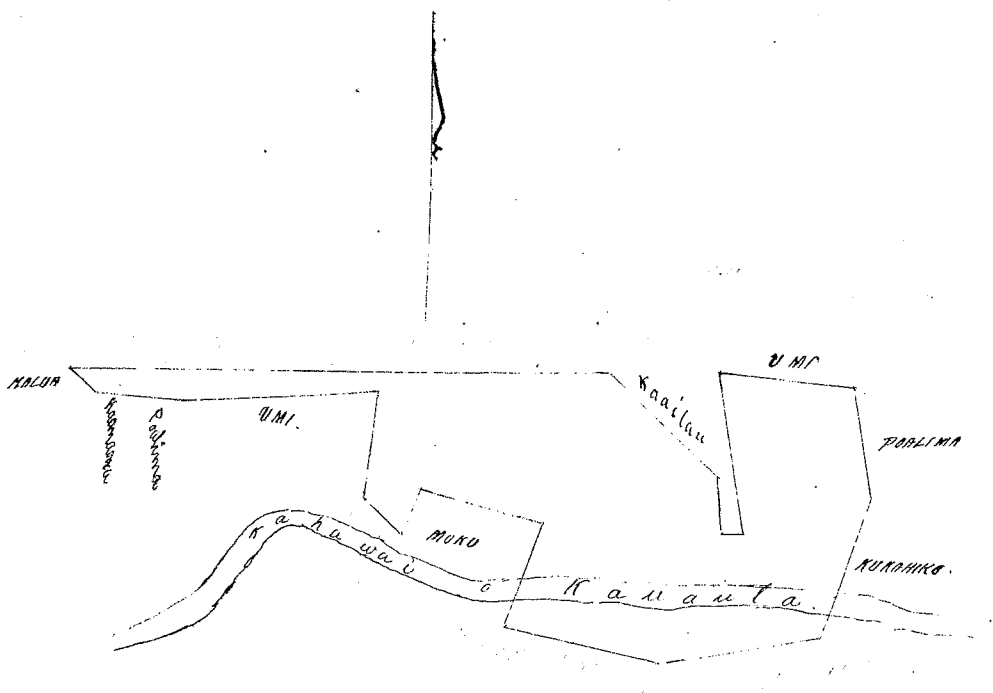

2 Kaulau = 1/11/18

Hulu 6873 Hukuhiko

Ua koi mai oia no kona mau Ahua Aina ma ka Ai o "Hanaia" ma ke Ahupuaa o Kaulau ma Lahaia, ma ke Moku o Mau; no ka mea, ua hana ia i ka mea i hiki mai wahi no Kaulau a me Keawe paha i ka mukuahiki 1844, a ua noho koe i ka olelo a hiki i ka manawa.

Oia ka makou i hoko mai no Hukuhiko, ke hulaana hoi kona mabala iho o ke Awa Alodii. Ima i uku mai ka oia i ke ke Ahupuaa hapaha; aia ia wa ke pua ia i ka Palapala Lahaia Alodii.

Pono mai ia i ke uku no ka hoholoana a me ka hoholo ana i ka olelo. Penei

- W. L. Lee
- G. M. Robertson
- C. H. Smith
- J. Kekaulau

No ka nui i me ke hua ana i ka olelo ma ka Nupepa.
 No ke kope ana i ka olelo hoiwa
 No ka palapala hoi
 No ka hana ana i ka la 4 o Iune 1853.
 No ke kope ana i ka olelo a ma hoi ke 1/2 Awa.
 No ke ana ana i ka la
 No ke kope ana
 No ka hoholo ana i ka olelo i ka la 15 o Iulai 1853.

Oia na palena: Anani e N. P. Alexander

	500

Aia no kona aina kuleana ma ke Ahupuaa o Hauaula ma Lahaina, Maui.

Apanui. Ma ka Ili o "Kanaia" E hoomaka ana ma ke kahi (Kema Komohana, a holo

Kema	65 ³ / ₄	Hikina	1.49	Kaul. e pili ana me Kahawai
Akau	42°	Hikina	3.50	" " " "
Akau	51 ³ / ₄	Komohana	0.24	" " " Umi
Kema	51°	Komohana	0.93	" " " "
Kema	43 ³ / ₄	Komohana	0.48	" " " "
Kema	72°	Komohana	0.63	" " " "
Akau	2 ³ / ₄	Komohana	0.88	" " " "
Kema	77 ¹ / ₂	Komohana	1.16	" " " "
Kema	6°	Hikina	1.00	" " " Poahina
Kema	71°	Hikina	0.40	" " " "
Kema	38 ³ / ₄	Komohana	0.63	" " " Kaaas i kahi i hoomaka ai

Ma ka Ili / Ruda o 24 Roda.

Apanui 2. E hoomaka ana ma ke kahi Kema Komohana, a e holo ana

Akau	10 ¹ / ₂	Hikina	0.73	Kaul. e pili ana me Kawailau
Akau	89°	Hikina	2.15	" " " Kalua
Akau	7 ³ / ₄	Hikina	0.35	" " " "
Akau	74°	Hikina	0.79	" " " "
Kema			0.66	" " " Kaanaana
Kema	79°	Komohana	0.22	" " " "
Kema	10 ¹ / ₂	Komohana	0.16	" " " "
Kema	39 ¹ / ₂	Komohana	0.26	" " " Honokoa
Kema	59 ¹ / ₂	Komohana	1.35	" " " "
Akau	79°	Komohana	1.67	" " " Kahawai i kahi i hoomaka ai.

Ma ka Ili 28 Roda

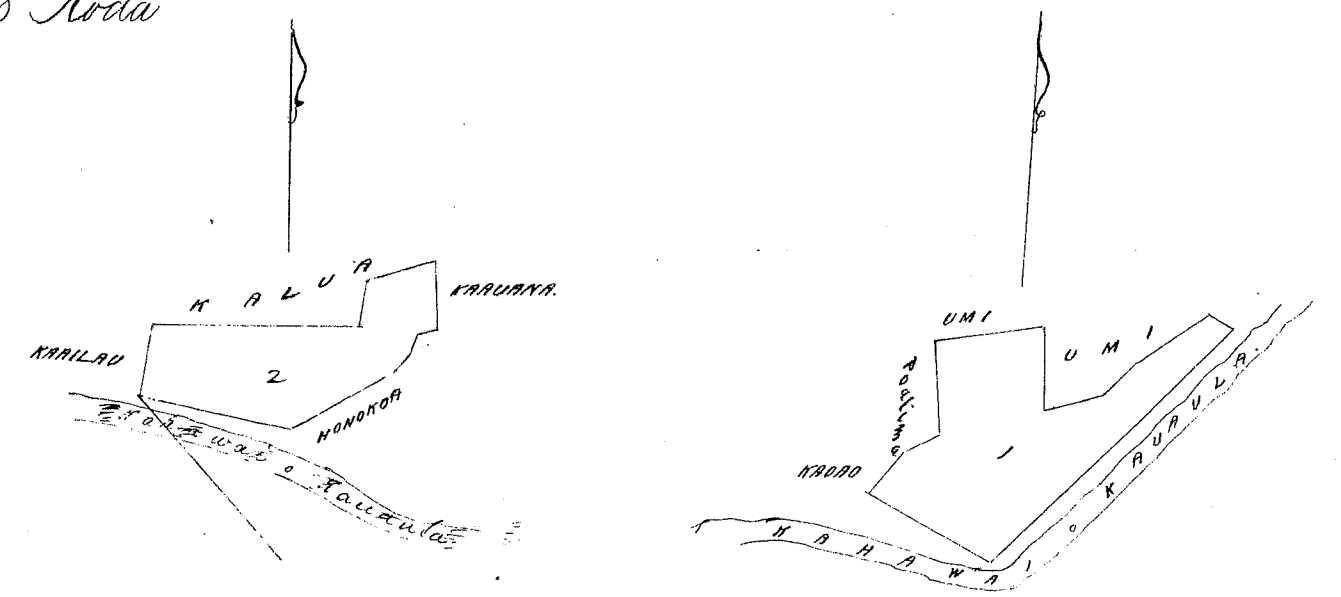

2 Kaulahao = 10000

Helu 6463 Kapu

Ua hoi mai oia no kona wahi Apanui aia ma ke Ahupuaa o Koinenui ma Lahaina ma ke Motu-puni o Maui; no ka mea, ua hoo ia ia keia wahi no Kaihelo mai i ka makahiki 1847, a no Suakini mai hoi ke Kaihelo i ka makahiki 1838, a ua noho keatea oleia a hiki i keia manawa.

Oia ka makou e hooke aku nei no Kapu; ke kuleana hoi kona malalo iho o ke Aho Aloha. Eia e uhu mai oia i ke ke Aupuni kapaaka; aiaia, ua kupo ia ia ka Palapala Sila Aloha.

- No ka iumi a me ke pui ana i ka olelo ma ka Nupepa
- No ke kope ana i ka olelo koina
- No ka palapala kii
- No ka hana ana i ka la 12 o June 1849.
- No ke kope ana i ma olelo a ma hiki 1/4 Awa.
- No ke ana ana i ka la
- No ke kope ana
- No ka hookele ana i ka olelo i ka la 15 o Julai 1853.

Eia ma palena. Anaia o N. P. Alexander

400

Aia koma aina kuleana ma ke Ahupuaa o Nainuenui ma Lahaina Maui.

E hoomaka ana ma ke kiki Akau Hikina, a e holo ana

Akau	72 1/2	Komohana	4.60	Kaul. e pili ana me Helelualani
Hema	12 1/4	Komohana	1.46	" " " Kaula
Hema	74 1/2	Hikina	3.75	" " " "
Akau	14	Hikina	0.27	" " " Palama
Hema	67	Hikina	1.00	" " " "
Akau	6	Komohana	0.33	" " " Upai
Akau	10 1/2	Hikina	0.90	" " " " i kahi i hoomaka ai.

Ka Iki

2 Ruda & 2 Roda.

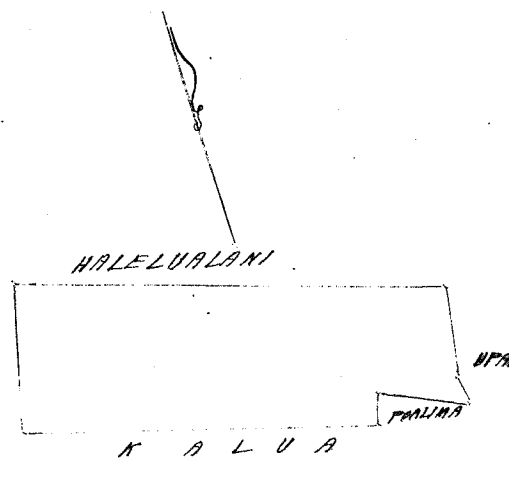

2 Kaulahas = Inika

Helu 6925 Pakala 126912

Ua hoi mai oia iro koma wahi Apau aina ma ke Ahupuaa o Aho ma Lahaina, ma ka 'Mokupuni' o Maui; no ka mea, ua loa ia ia keia wahi no Lani mai i ka manawa mamua aku o ka M. C. 1839, a ua noho keakea oia a hiki i keia manawa.

Oia ka makou e hooke nei no Pakala; he kuleana hoi koma, malalo iho o ke Aho Aloha. Ima e ukou mai oia i ke ke Ahupuaa kapaaka; a e hooke i ke ke Palapala Aho Aloha.

- Pono mai i ke ke ukou no ka hooke oia i ke ke hooke ana i ke olelo. Penei
- No ka oumi a me ke pui ana i ke olelo ma ke Mupupa.
 - No ka kape ana i ke olelo koma
 - No ka palapala kii
 - No ka hana ana i ke olelo 4 o June 1849
 - No ke kope ana i ke olelo ma ke hooke 1/3 Aho
 - No ke ana ana i ke kaha
 - No ke kope ana
 - No ka hooke ana i ke olelo i ke kaha 15 o Iulai 1853.

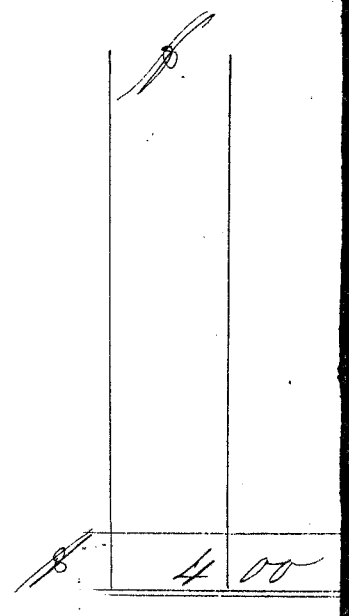

Oia ma palama. Aia o St. P. Alexander.

Aia koma aina kuleana ma ke Ahupuaa o Aho i Lahaina, Maui. E hoomaka ana ma ke kiki Hema Hikina a e holo ana

Akau	5 1/4	Hikina	0.54	Kaul. e pili ana me Kapule.
Akau	38	Komohana	1.37	" " " Palama
Hema	57 1/2	Komohana	0.83	" " " Palama
Hema	31 1/2	Hikina	0.49	" " " Palama
Hema	35 1/2	Komohana	0.61	" " " "
Akau	52 1/2	Komohana	0.66	" " " "
Hema	34	Komohana	3.04	" " " Palama
Hema	3	Komohana	1.23	" " " "
Hema	88 1/4	Hikina	1.26	" " " Kahawai
Akau	34 1/4	Hikina	1.87	" " " Kapule
Akau	45 1/4	Hikina	2.26	" " " i kahi i hoomaka ai.

Ka Iki

3 Ruda & 19 Roda.

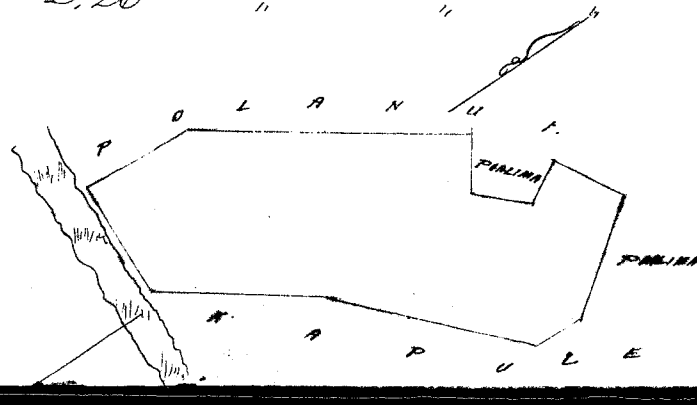

2 Kaulahas = INIKA

Helu 6875 Kaulahoa I + 1271 12

Apana 2.

Ua koi mai oia no kona mau Apana aino ma ke Ahupuaa o Mio a me Pukunohu ma Lahaina ma ke Mokupuni o Maui; no ka mea, ua loaa ia ia keia mau wahine no Lani mai i ka wa o Hoapili manua aku o ka M. A. 1839, a ua noho keakea oleia a hiki i keia manawa.

Oia ka makou e hooke me no Kaulahoa; ke kula ana hoi kona malalo iho o ke Ano Aloidio. Inu e uku mai oia i ke ke Ahupuaa hupahua; alaila ua hupono ia ia ke Palapala Sita Aloidio.

Pono mau ia ia ke uku no ka hooke hooke a me ka hooke ana i ka olelo. *Pono*

- W. L. Lee No ka rami a me ke paai ana i ka olelo ma ke Muepapa
- G. M. Robertson No ke kope ana i ka olelo koina
- C. H. Smith No ka palapala keia
- A. Kaulahoa No ka hana ana i ka la 4 o Iune 1849
- No ke kope ana i ma olelo ana ma hoi ke 1/2 Awan
- No ke ana ana i ka la
- No ke kope ana
- No ka hooke ana i ka olelo i ka la 15 o Iulai 1853

600	

Eia ma palena. Apana 2. Apana 1. Apana 3.

Oia mai ke koina o kona kula ana e waiho ana ma ke Ahupuaa o Mio a me Pukunohu ma Lahaina Maui. Apana 1. Aia ma ke koina ma Mio. E hoomaka ana ma ke kiki i ka hooke ana, a e holo ana

Hema 6 1/2	Hikina	0.48	Kaul. e pili ana me Lipi
Kau 68	Hikina	0.53	" " " "
Hema 84	Hikina	0.57	" " " "
Kau 3	Hikina	0.45	" " " Kaulahoa
Hema 83 1/2	Komohana	1.12	" " " Lani i kahi i hoomaka ai.

Ka Ki 7 Roda

Apana 2. Aia no ma ke koina ma Mio. E hoomaka ana ma ke kiki i ka hooke ana a e holo ana

Kau 77	Komohana	0.93	Kaul. e pili ana me Lipi
Kau 61	Komohana	1.98	" " " Paauo
Kau 82	Komohana	0.62	" " " "
Hema 8 1/4	Komohana	1.32	" " " Lani
Kau 71 1/4	Komohana	0.65	" " " "
Hema 7	Komohana	0.56	" " " Auwai
Hema 66 1/4	Hikina	0.64	" " " Lani
Hema 70 1/4	Hikina	0.43	" " " "
Hema 16	Komohana	0.76	" " " "
Hema 70 1/4	Hikina	0.45	" " " Kaulahoa
Kau 11	Hikina	0.32	" " " Lani
Hema 77 1/2	Hikina	0.30	" " " "
Hema 1/2	Komohana	0.33	" " " "
Hema 71 1/2	Hikina	0.17	" " " Kaulahoa
Kau 51 1/2	Hikina	3.07	" " " Kaulahoa a hiki i kahi i hoomaka ai.

Ka Ki 2 Roda & 17 Roda

Apana 3. E hoomaka ana i ke kiki i ka hooke ana a e holo ana

Kau 78	Komohana	0.39	Kaul. e pili ana me Kaulahoa
Hema 21 1/2	Komohana	0.66	" " " Paauo
Kau 46 1/4	Komohana	1.05	" " " "
Kau 41 1/4	Hikina	0.47	" " " "
Kau 42 1/4	Komohana	0.27	" " " "
Hema 45 1/2	Komohana	1.27	" " " ka Auwai
Hema 50 1/4	Hikina	0.53	" " " Paauo
Kau 62	Hikina	0.21	" " " Lani
Hema 48 1/2	Hikina	0.52	" " " "

Hema	39 3/4	Komohana	0.28	Kaul. e fili ana me Lani
Mau	51	Komohana	0.53	" " " "
Hema	42	Komohana	0.30	" " " " Palani
Hema	42	Hikina	0.70	" " " " Palani
Hema	46	Komohana	0.67	" " " "
Hema	40	Hikina	0.33	" " " "
Mau	47 1/4	Hikina	0.68	" " " "
Hema	40 3/4	Hikina	0.12	" " " "
Hema	32	Komohana	0.69	" " " "
Hema	1 3/4	Komohana	0.63	" " " " Mahema
Hema	88 1/4	Hikina	0.24	" " " " Pule
Mau	38 1/2	Hikina	1.59	" " " " Kahawai
Mau	13 3/4	Hikina	1.70	" " " " Kaaituku i kahi i hoomaka ai.

Ka Iki

1 Ruda & 21 Ruda.

Apana 4.

Aia i ka Puhuehuki o Laakili. E hoomaka ana i ke kahi Hema Hikina a e holo ana

Mau	7 1/4	Hikina	0.56	Kaul. e fili ana me Palani
Hema	85 1/2	Komohana	2.30	" " " " Puhuehukui
Hema	26 1/4	Hikina	0.79	" " " " Makila
Mau	69	Hikina	0.36	" " " " Palani
Hema	27 1/2	Hikina	0.32	" " " "
Mau	55	Hikina	0.60	" " " "
Mau	79 1/2	Hikina	1.00	" " " " i kahi i hoomaka ai.

Ka Iki

23 Mau Ruda.

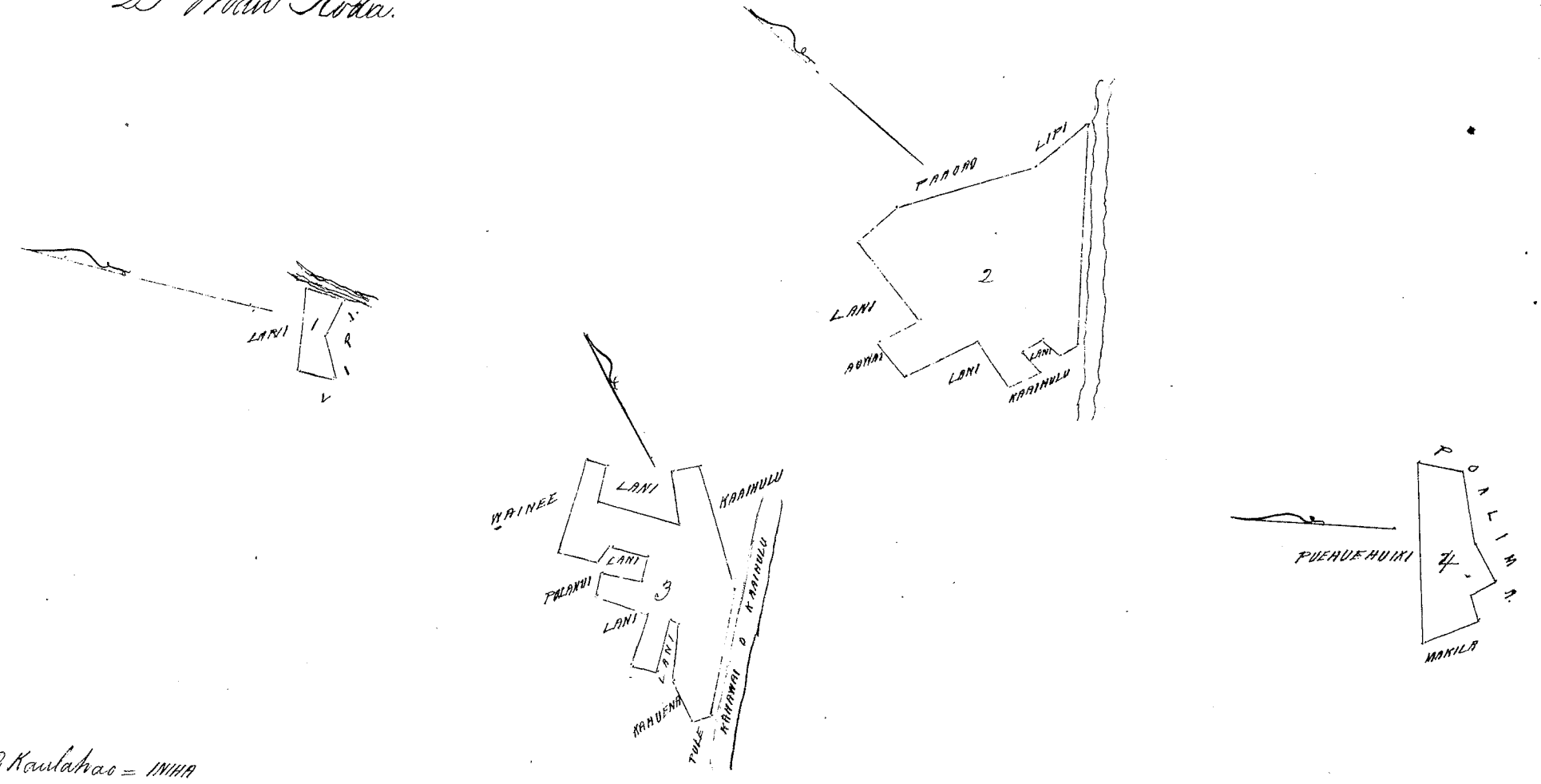

2 Kaulahas = 11111

Helu 1119 Kahu

Ua hoi mai oia no kona Apana aino ma ka Iki o Kewalo Paua i Honolulu aino ma Kona, ma ka Moku o Oahu; no ka mea; ua loa ia ia i keia wahi no Ihu mai ke komohuki i ka wa no e ola ana o Kinau, mamua aku o ka Makahiki 1839, a ua noho ka ka oleia a hiki i keia manawa.

Ua ka makou e hooke me i ka Kahu; he kuleana hoi kona amatate iho o ke Aho Alodio. Ima e uku mai oia i ho ke Aupuni hapaha; aiaia, ua kupono ia ia ka Palapala Sita Alodio.

Toru nae ia ia ke uku no ka hookelelele a me ka hookelelele ana i ka olelo. Penei

- W. L. Lee
- G. M. Robertson
- C. H. Smith
- J. K. Kaulahas

No ka rumi a me ke pua ana i ka olelo ma ka Muepa
 No ke kope ana i ka olelo koira
 No ka palapala hii
 No ka hana ana i ka ka
 No ke kope ana i ka olelo a ma hoi ke
 No ke ana ana i ka la 4 o June 1853.
 No ke kope ana
 No ka hookelelele ana i ka olelo i ka la 20 o July 1853.

Anaia e S. P. Kalama.

Aina ma Keuato Paua, Honolulu, Oahu.

Loi me Kula. Ma ka pohaku i hoailonaia x. ma ka papohaku o J. Booth... 188 Pauku me Honolulu... 100 Pauku, a Heema 38° 30'... 114 Pauku, a Heema 52°... 164 Pauku, a Heema 55°... 131 Pauku, a Heema 64° 45'... 97 Pauku... 328 Pauku... 77° 30'... 556 Pauku...

Eia ka Ili 1 22/100 Eka.

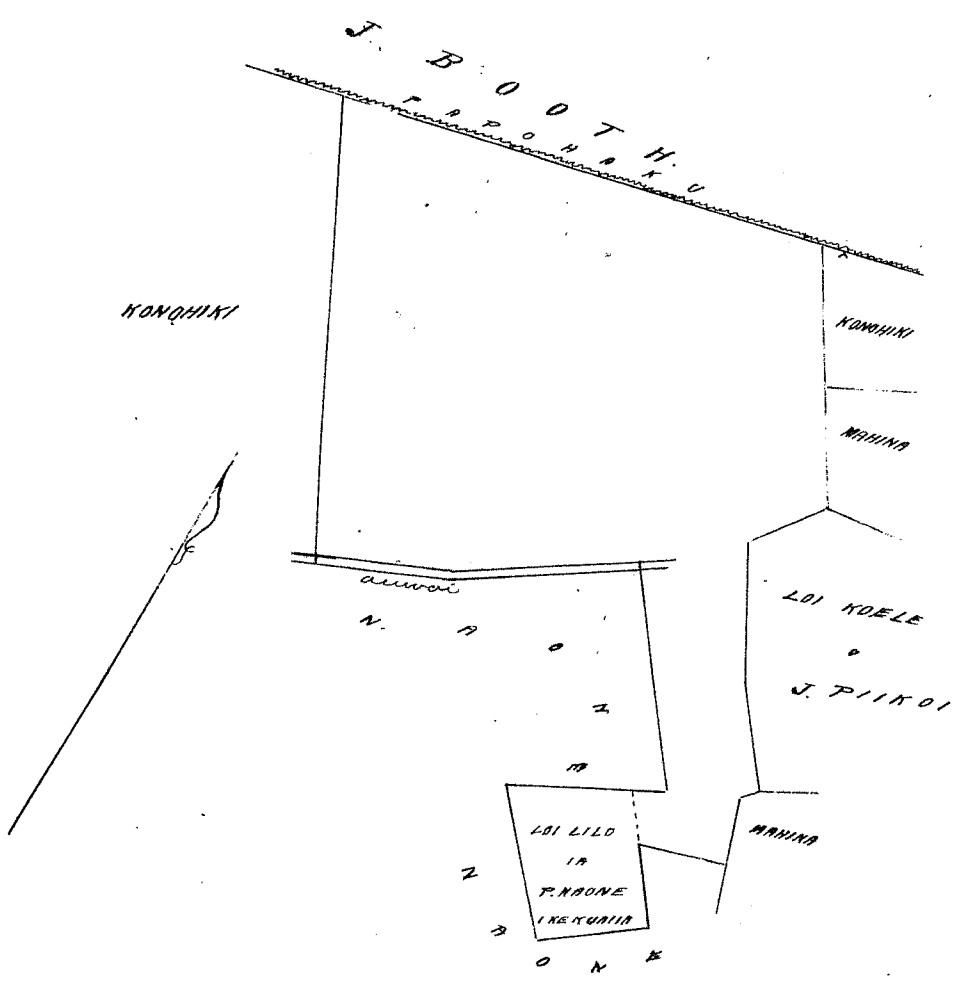

Hele 3943 Nihonui

Ua koi mai oia no kona wahie Apiana aina ma ka Ili o Niupaiapai i Honolulu, ma Kona, ma...

Oia ka makou i hooko me no Nihonui; he kuleana hoi kona malalo iho o ke Aho Alodia...

- No ka oomi a me ke papai ana i ke olelo ma ka Niupaiapai, -
No ka kope ana i ke olelo koina
No ka palapala kii
No ka hana ana i ke la 23 o Iulai 1851
No ke kope ana i wa o lele a ma hoike 1/4 araa
No ke ana ana i ke la 18 o Iulai 1853 Ukuia ke ana #6.
No ke kope ana
No ka hooholo ana i ke olelo i ke la 20 o Iulai 1853

Eia ma palewa. Anaia e S. P. Kalama.

Loi ma Niupaiapai, Honolulu, Kona, Oahu. E hoouka ma ke kahi Konoehana e pili ana me ka palewa o Kiniakua, a e holo Heema 45°... 162 Pauku me Kuniakua a me Honolulu a hiki i ke pohaku o ka auwai, - Alaila Heema 36°... 111 Pauku me Honolulu, - Alaila Heema 41° 30'... 9 Pauku, a me Heema 42°... 129 Pauku me Kuniakua a hiki i ke Kuniakua; - Alaila Heema 45° 30'... 53 Pauku, a me Heema 45° 30'...

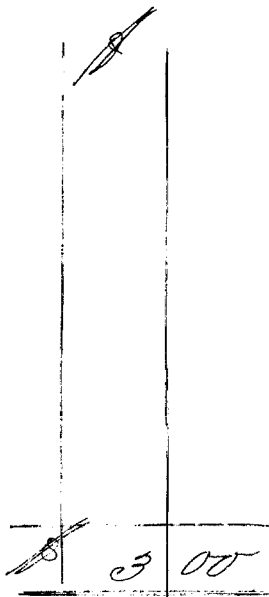

Kom. 71 Panku, a me Akau 71 Panku Kom. 23 Panku, a me Akau 1° Kom. 148 Panku meko Kiriakua, a hiki i ka hoomaka ana. Eia ka Ili Hapalawa o ka Eka.

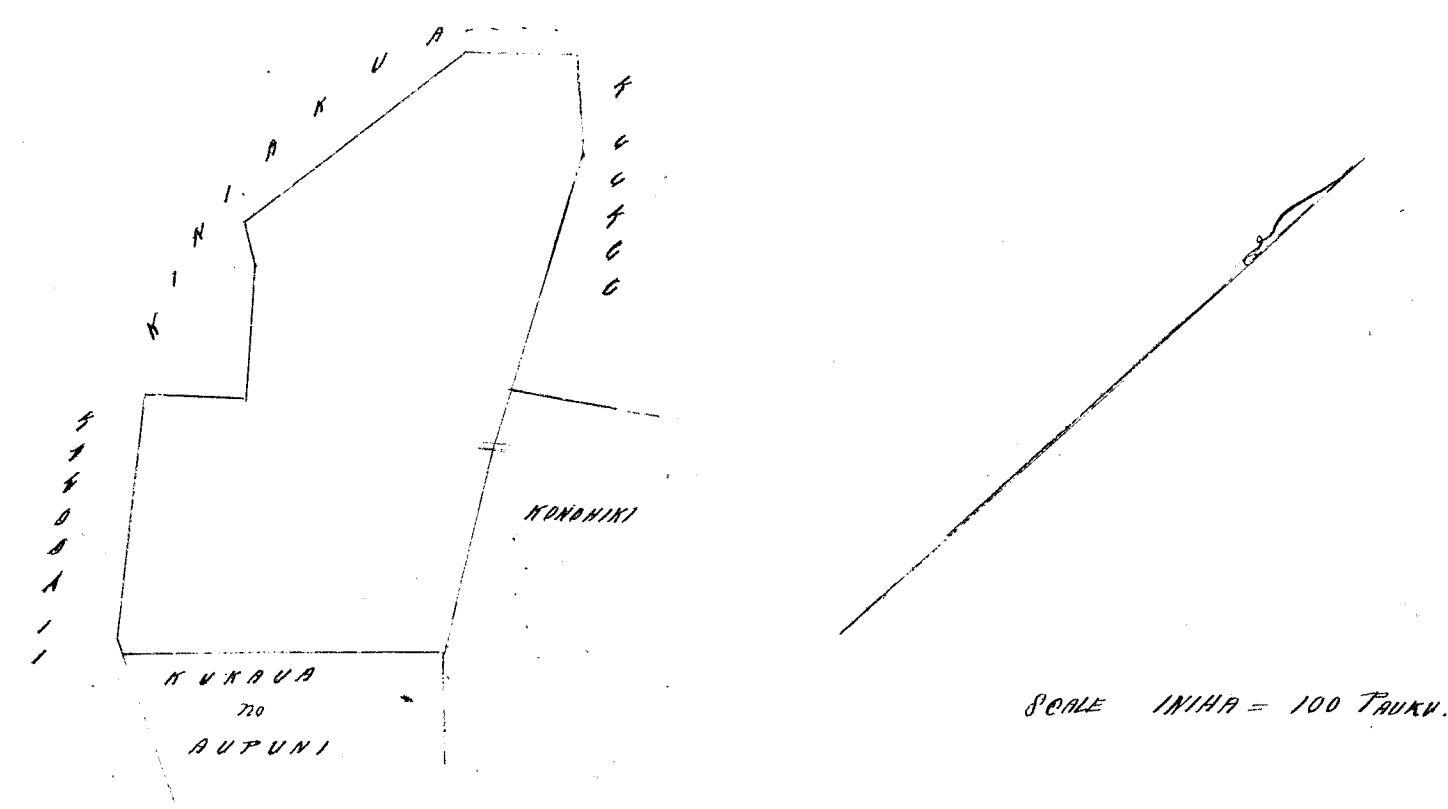

Kelu 758 Kahoopii

Ua koi mai oia no kona Apawa aina me ka Ili o Niupaiapai i Honolulu, ma kona, ma ka Mookupuni o Oahu; no ka mea, ua loa iaia keia wahi no Kaiwi mai i ka M. A. 1846, a ua loa hoi ia Kaiwi no M. Kekuanana mai i w mahahiki no, a ua noho keakea oia a hiki i keia manawa.

Oia ka makou hooke me no Kahoopii; he kuleana hoi kona malalo iho o ke Ano Alodio. Ina e ukui mai oia i ke ke Aupuni hapaha; aiaia, ma kuponua ia i ke Palapala Lela Alodio.

Pono na ia ia ke ukui no ka hooholo a me ka hooholo ana i ka olelo. Penei

- W. L. Lee
- G. M. Robertson
- J. H. Smith
- J. Kikiantaka

- No ka rumi a me ke pahi ana i ka olelo ma ka Muepua.
- No ke ~~hoo~~ ana i ka olelo kona
- No ka palapala kii
- No ka hana ana i ka la 24 o Iulai 1851
- No ke kupa ana i, na olelo a ma huike 1/2 Ano
- No ke ana ana i ka la 3 o Augate 1852. Ukuia ke ana 1/6.
- No ke kope ana.
- No ka hooholo ana i ka olelo i ka la 20 o Iulai 1853.

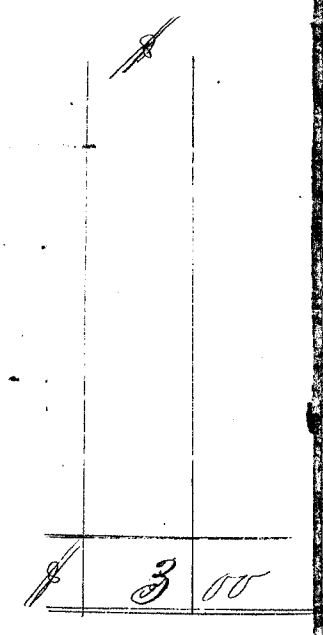

Eia na palena. Anai e S. P. Kalamu.

5 Loi ma Niupaiapai, Honolulu, Oahu.

E hoomaka ma ke kiki Kama o na Loi, Kukaua no ke Aupuni, kiki Kikina o keia aina, - a e holo Kama 5° Kom. 17 Panku, - a me Kama 34° Kom. 1 Kaulahu ma ka mokuna me "Pualalo", - aiaia Akau 65° 30' Kom. 2, 18 Panku ma ka mokuna me "Kiri"; - aiaia Akau 10° Kom. 108 Panku, a me Akau 25° 30' (Kikina) 74 Panku ma ka palena me Kiriakua, - aiaia Kama 42° (Kikina) 129 Panku, - a me Kama 61° 30' (Kikina) 73 Panku ma ka palena o Kihonu me Aupuni, - aiaia neene kuponua hana hana 19 Panku, kiki keake, a me Kama 58° 45' (Kikina) 94 Panku ma ka palena me Aupuni a hiki i ka hoomaka ia. Eia ka Ili, 345 Auna.

Augate 3. 1852.

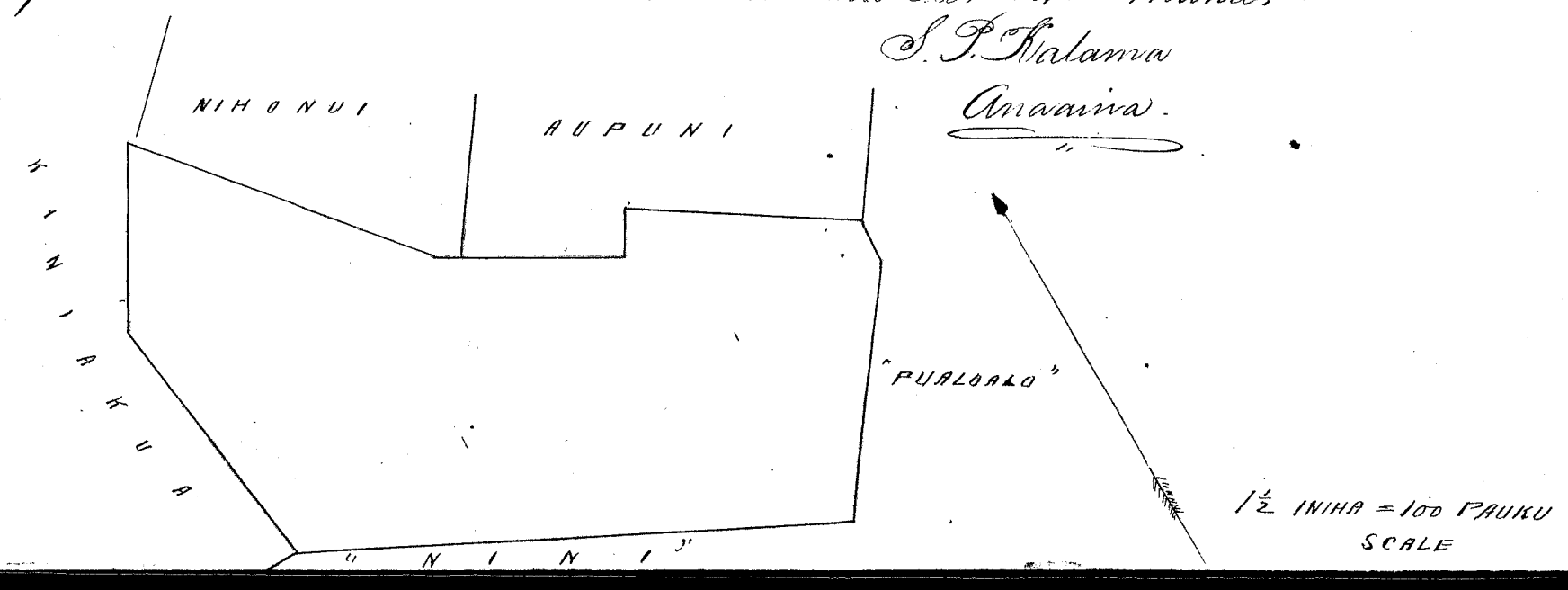

Helu 2286 Kekapai

Nawanaoia

Ua hoi mai oia no kona. Apana aina ma ka Ii o Kaolu Nuuanu i Honolulu ma kona ma ka Mokupuni o Oahu, no ka mea, ua loa ia i keia wahi no Kailimelemele mai i ka M. H. 1852, a ua noho koke oia a hiki i keia manawa.

Oia ka makou e hoohe me no Kekapai; he kule ana hoi kona malalo iho o ke Ano Alodio. Ima e ukui mai oia iho ke Aupuni hapaha; alaila, ua kupo ia ia ka Palapala Sila Alodio.

Pono mai ia i ke ukui no ka hoohehoohe a me ka hoohehoohe ana i ka olelo. Penei

- W. L. Lee
- G. M. Robertson
- J. H. Smith
- J. Kahantaha

- No ka rumi a me ke pui ana i ka olelo ma ka Nupepa
- No ke kope ana i ka olelo hona
- No ka palapala kii
- No ka hana ana i ka la 13 o Oct 1851
- No ke kope ana i ka olelo a ma hoike 14 Oas
- No ke ana ana i ka la 16 o Maraki 1853. (Ukui ke ana \$4.00.)
- No ke kope ana
- No ka hoohehoohe ana i ka olelo i ka la 20 o Iulai 1853.

	5	00
--	---	----

Eia na palena.

Maia o S. P. Kalama.

Ma Kaolu Nuuanu, Honolulu, Oahu

Nawanaoia

7 Poi a me Kahuahale. E hoomaka ma ke kihi Hema o keia aina ma ke pua ma ka o ka papohaku ma ka lihi ma ka o ke Alanui Nui a pili ana me ka lihi Akau o ke Alanui Nuuanu, a i holo Akau 48° 30m. 478 Pautu ma ka kihi ma ka o ke Alanui Hale a hiki i ka lihi auwai; - Alaila Akau 64° Hikina 125 Pautu, a me Akau 78° 15' Hikina 87 Pautu ma ka auwai i waena o keia me ka uka a me ka papohaku o G. P. Judd a hiki i ka papohaku; Alaila Hema 48° Hikina 352 Pautu mawaho o ka papohaku o G. P. Judd a hiki i ke Alanui Nuuanu; Alaila Hema 33° 15' Kom. 185 Pautu mawaho i ka papohaku o keia me ka lihi Alanui Nuuanu a hiki i ka hoomaka ana.

Maia Aina 957 Amana 33 Kapua.

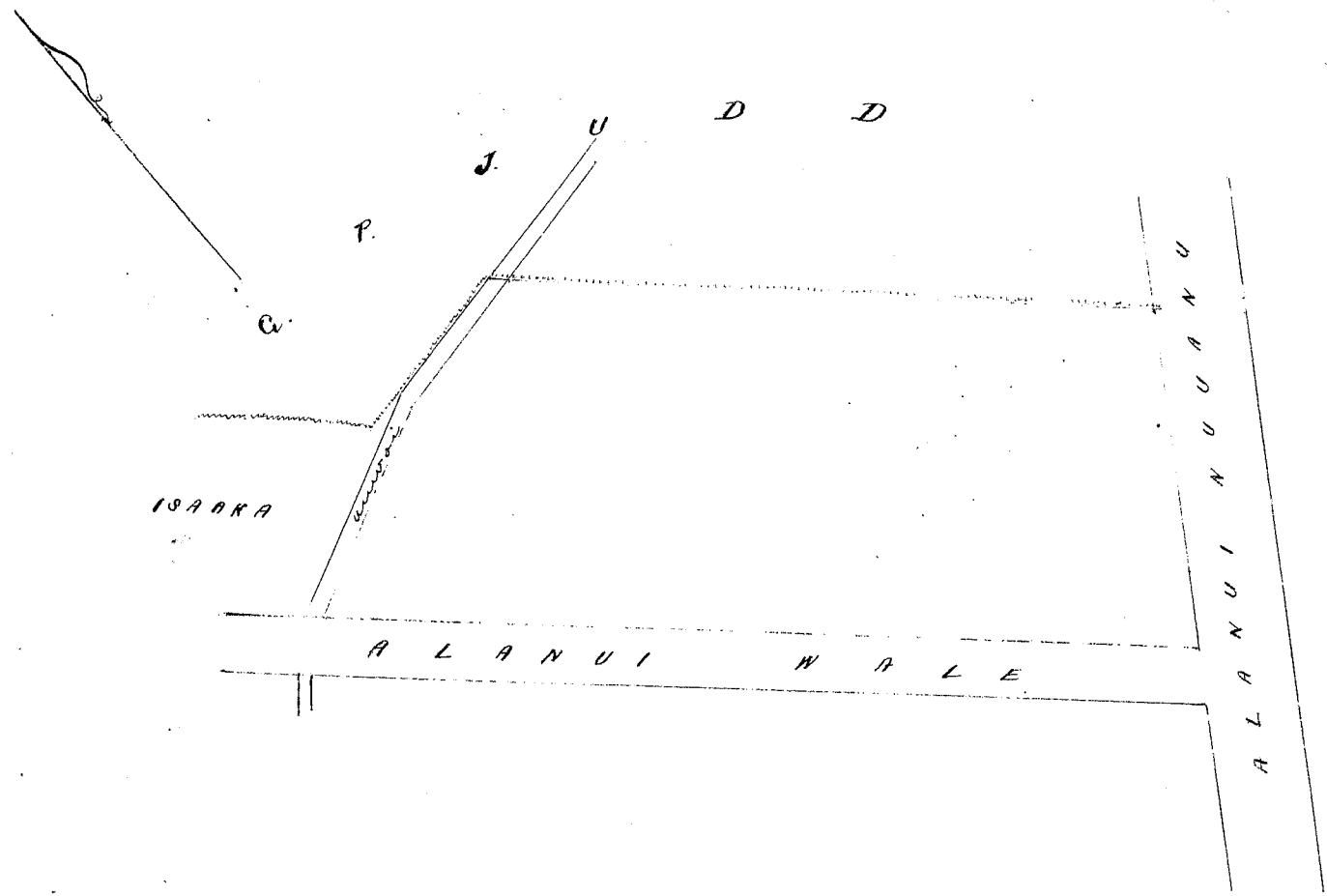

Helu 3376 B Kanealii

Ua hoi mai oia no kona. Apana aina ma ka Ii o Kewalo Paua i Honolulu ma kona ma ka Mokupuni o Oahu, no ka mea, ua loa ia i keia Apana aina no Ima mai i ka M. H. 1838 mamua aku o ka make ana o Kinau i ka M. H. 1839, a ua noho oia malaila a hiki i kona make ana i ka M. H. 1849, ma ka oia i keia wahi no I. Kaaukai kana aikane; a ke noho me no I. Kaaukai malaila a hiki i keia manawa.

Oia ka makou e hoohe me no Kanealii a ia I. Kaaukai kana aikane; he kule ana hoi kona ma lalo iho o ke Ano Alodio. Ima e ukui mai oia iho ke Aupuni hapaha; alaila, ua kupo ia ia ka Palapala Sila Alodio.

Pono mai ia i ke ukui no ka hoohehoohe a me ka hoohehoohe ana i ka olelo. Penei

W. L. Lee
G. M. Robertson
J. H. Smith
J. Kekaulahao

No ka oumi a me ke faai ana i ka olelo ana ka Niuepa.
No ke kope ana i ka olelo koima
No ka fakapala kii
No ka huna ana i ka la 5 o Dekemaba 1853,
No ke kope ana i ma olelo a ma hooke 1/2 avao
No ke ana ana i ka la 12 o Iulai 1853.
No ke kope ana
No ka hoohele ana i ka olelo i ka la 20 o Iulai 1853.

6 00

Oia na palena. O Anai e S. P. Kalama.

Ana ma Kewalo Paua, Honolulu, Oahu.

Loi me Kahuakalo. E hoomaka ma ke hiki Komohana Akau o keia ana e fili ana me ke ana o
J. Booth, a e holo Akau 51° 15' Hikiina 132 Pautu e fili ana me J. Booth, - Alaila Hema 20° Hikiina 3 Kaulahao, - a me
Hema 30° 30' Hikiina 88 Pautu, - a me Hema 14° 45' Hikiina 95 Pautu, - a me Hema 47° Kom. 32 Pautu, a me Hema 17°
Hikiina 464 Pautu e fili ana me J. Booth, - Alaila Hema 70° Kom. 91 Pautu me Iao, - Alaila Akau 19° Kom. 667 Pautu
me J. Booth a hiki i ka papohaku, - a Akau 33° 15' Hikiina 20 Pautu ma ka papohaku, - a me Akau 20° 15' Kom. 238
Pautu e fili ana me J. Booth a hiki i ka hoomaka ana.

Oia ka Ii 1 7/100 Eka

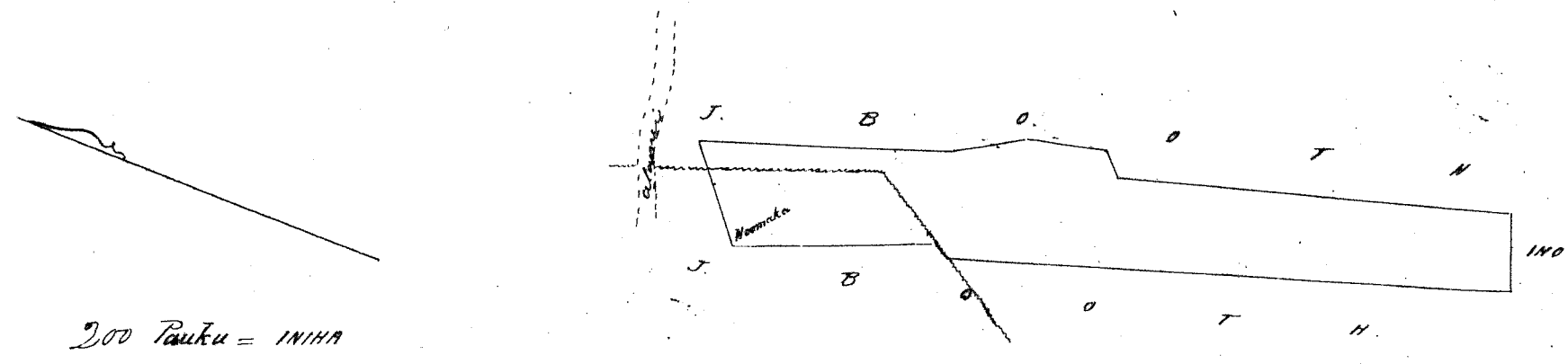

Hele 6233 Kahuakalo Kahuakalo

Ua hoi mai oia no kona mau Aprana ana ma ka Ii o Kahuakalo Nuuano i Honolulu, ma kona, ma
ka Mokupuni o Oahu, no ka mea, ua lona ia ia keia mau wahi no Kekaulike mai i ka manawa o ke kaia ana i Kawai i ka
M. S. 1824, a ua noho mau a hiki i keia manawa. Ika, i keia manawa iho nei, wa keakea mai o Mr. Kekuanana i keia huleana
a wa kaili ae i ka ana mai a Kahuakalo mai, a wa kipa kipa, a na Mr. Kekuanana e wahi ana a hiki i keia manawa.
A ua lono mai na avao elua i ma hooke e faai i ka hoo paapa, a ua hamaia imua o ma Luma Kona ma ka la 26 o
Okatoba 1852, a ua hele kekahi mau Luma Kona e mana pono i keia wahi e hoo paapaia ana, a ua hoohele iho ma ka
i ka olelo no keia huleana e like me ke hooke ana o keia mau kii malalo nei.

Oia ka mukua e hooke nei no Kahuakalo, he huleana hoi kona malalo iho o ke avao Alodis. Ana e ukua
mai oia i ke ke Aupuni kapaha; alaila, wa kupaia ia ia ka Palapala Ika Alodis.

Pono na ia ia ke ukua no ka hoohele ana a me ke hoohele ana i ka olelo. Poni.

W. L. Lee
G. M. Robertson
J. H. Smith
J. Kekaulahao

No ka oumi a me ke faai ana i ka olelo ma ka Niuepa
No ke kope ana i ka olelo koima
No ka fakapala kii
No ka huna ana i ka la
No ke kope ana i ma olelo a ma hooke 5 avao
No ke ana ana i ka la 30 o Maraki 1853.
No ke kope ana
No ka hoohele ana i ka olelo i ka la 20 o Iulai 1853.

6 00

Oia na palena. O Anai e S. P. Kalama.

Ana ma Kahuakalo, Nuuano, Honolulu, Oahu.

Aprana. Loi. E hoomaka ma ke hiki Komohana o keia Loi e fili ana me Aupuni a me I mo Akau
mau, a e holo Hema 47° Hikiina 84 Pautu hiki ana, a me Akau 39° 30' Hikiina 128 Pautu e fili ana me

ka aina o ke Aupuni; - Alaila Akau 43° Kom. 56 Pautu, a me Honua 52° Kom. 13. Pautu e pili ana me I me
Hainawa a hiki i ka hounaha ana. Eia ka Ili 22/1000 Eka

Apana 2. Kula mahiai. E hounaha ma ka papohaku hounaha ana x ma ke kahi Hikinua Akau o ka aina
o Pahili, a e holo Honua 44° Hikinua 145 Pautu e pili ana me ka aina o A. Pahi; Alaila Akau 41° 45' Hikinua 126
Pautu e pili ana me ka aina o ke Aupuni; Alaila Akau 47° Kom. 173 Pautu e pili ana me ke Mahoe; Alaila
Honua 43° Kom. 105 Pautu e pili ana me Kuaana; - Alaila Honua 38° Hikinua 30 Pautu me Pahili a hiki i ka hounaha
ma ka ana, Eia ka Ili 20/100 Eka

Apana 3. Loi me Kula me Kahuahale. E hounaha ana ma ka Ili Akau o ke Aupuni, ma ke kahi Akau
o ka aina o Levi Kaaleha e pili ana me ke A. Pahi; a e holo Honua 10 Pautu, ke ke papohaku, a me Akau 57°
Hikinua 34 Pautu ma ka papohaku me ke Aupuni a A. Pahi; - Alaila Akau 38° Kom. 100 Pautu, a me Honua 50° Hikinua
5 Pautu, kahi, a me Akau 49° Kom. 145 Pautu, kahi Akau, a me Honua 36° Kom. 55 Pautu, a me Honua 50° Hikinua
82 Pautu, a me Honua 44° Kom. 226 Pautu e pili ana me ka aina o ke Aupuni a hiki i ka papohaku ma ka palena
aina o A. Pahi, Alaila Honua 38° Hikinua 76 Pautu me A. Pahi a hiki i ka palena o Levi Kaaleha; Alaila Akau
61° Hikinua 233 Pautu e pili ana me Levi Kaaleha a hiki i ka hounaha ana. Eia ka Ili 37/100 Eka
Pautu 62/1000 Eka.

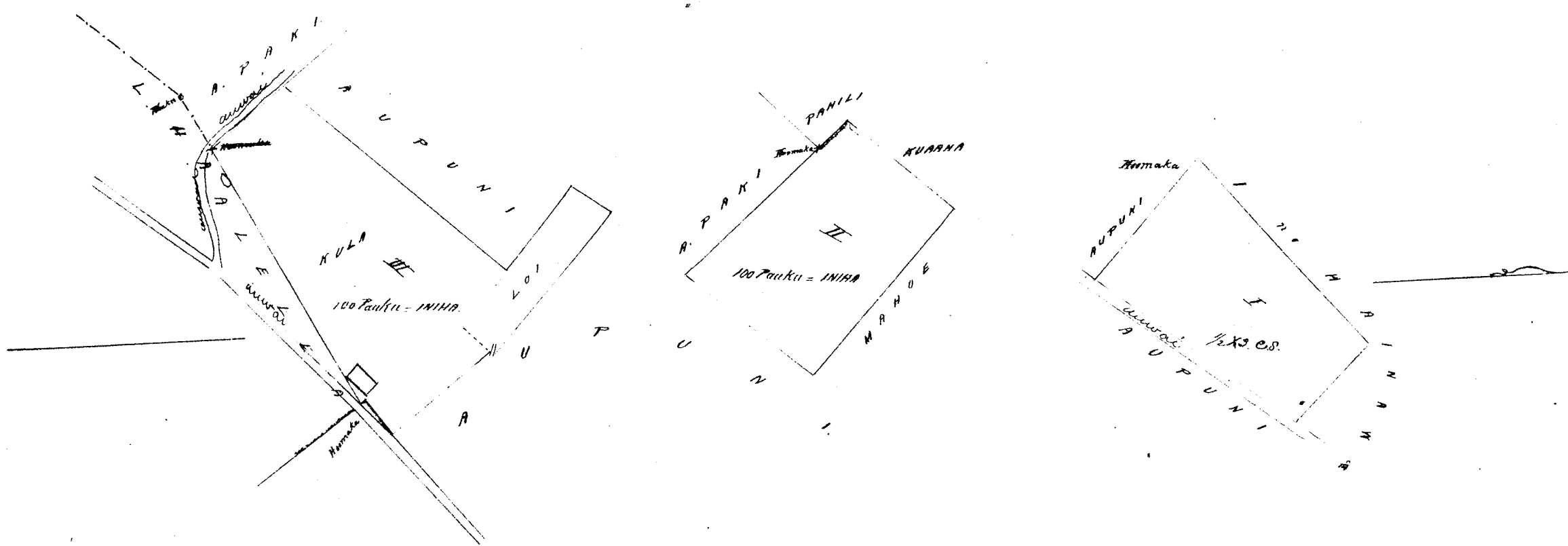

Hele 599 Heauiakole

Ua koi mai oia mo kona Apana Aina ma ka Ili o Kauhakohu, Nuuanu Honolulu ma (Kona),
ma ka Motupuni o Oahu; no ka mea, waiwai ia ia keia wahine. Iuakini mai i ka wai o Pahi ma i holo ai i
Sahiti i ka M. H. 1829, a uawoho keu keu oleia a hiki i keia manawa.

Oia ka mukou e hooke me mo Heauiakole; ke kuleana hooke ma alalo iho o ke Awa Alodii. Ina e uku
mai oia i ke ke Aupuni hapaha; alaila, wa hounaha ia ia ke Palapala Hele Alodii.

Tono na ia ia ke uku mo ka hounaha a me ka hounaha ana i ka olelo. Penei,

- W. L. Lee
- G. M. Robertson
- J. H. Smith
- J. K. Kaula

- No ke kumu a me ke pili ana i ka olelo ma ka Nupepa
- No ke kope ana i ke olelo koina
- No ka palapala hii
- No ka hounaha ana i ka la 16 o Novemaba 1847.
- No ke kope ana i na olelo a ma hooke 1/3 Awa
- No ke awa ana i ka la 13 o Aperila 1852.
- No ke kope ana
- No ka hounaha ana i ka olelo i ka la 20 o Iulai 1853.

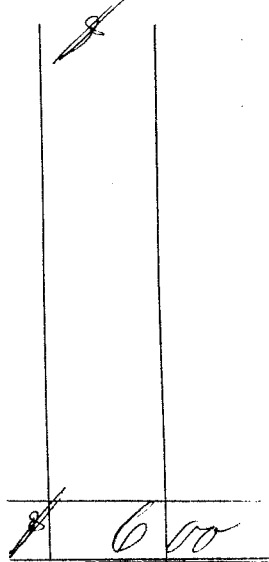

Eia ma palena. Aina o S. P. Kalamia.

Aina ma Kauhakohu Nuuanu Honolulu, Oahu.
Aina Kula me Kula Mahiai. E hounaha ma ke kahi Akau o keia aina ma ka Ili Honua o ke Kahuahale,
a e holo Honua 40° 15' Hikinua 276 Pautu, a hooke, a me Honua 42° 30' Hikinua 154 Pautu i ke kahi Hikinua o keia, a
me Honua 40° Kom. 265 Pautu e pili ana me ka aina o Namaanu a hiki i ka papohaku o Kuaana; - Alaila Akau

42° 30' Kom. 573 Panku, keke ma auwai, - a me Kema 47° Kom. 302 Panku ma auwai, kiki; - a me Kema 42° 30' Kom. 202 Panku e pili ana me ka aino o Kuana a me ko Opunui a hiki i Kahawai, - Alaila holo ika ma ka lili Kema o Kahawai a hiki i ka hoomaka ana.

Oia ka Ili

188/100 Eka

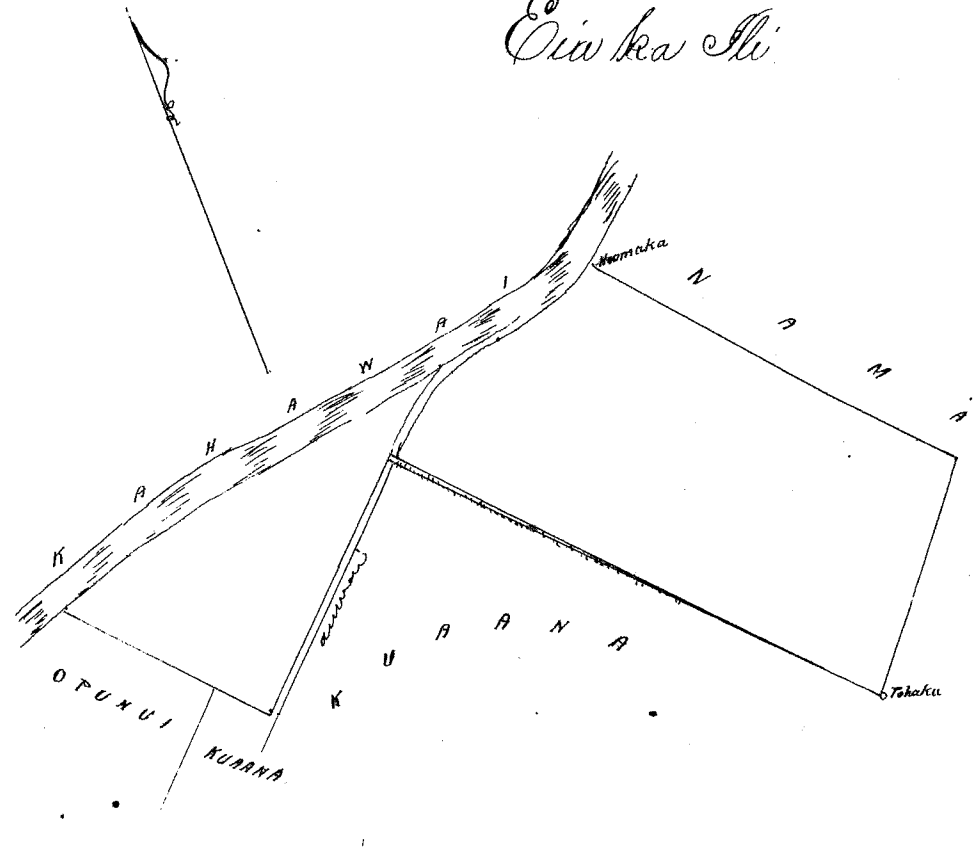

Helu 6256 Kaanaana

Ua koi mai oia ma kona Apana aino ma ka Ili o Kaolu Nuuanu i Honolulu, ma Kona, ma ka Mokuaunui o Oahu, no ka mea, ua hooia ia ia keia wahi no Kailimelimele mai maanawa aku o ka M. H. 1839, a ua noho keia oleia a hiki i keia manawa.

Oia ka makou i hooia nei no Kaanaana, ke kuleana hiki kona malalo iho o ke Awa Aloha. Ima e uku mai oia i ke ka Aupuni hapaha, alaila, ua koi mai ia ia ka Palapala Sila Aloha.

- No ka rumi a me ke pua ma i ka olelo ma ka Muepua
- No ka kope ana i ka olelo koira
- No ka palapala kii
- No ka hana ana i ka la 26 o Iekemaha 1850.
- No ke kope ana i ma olelo a ma hooia 1/2 Awa
- No ke ana ana i ka la 22 o Iulai 1853.
- No ke kope ana
- No ka hooia ana i ka olelo i ka la 23 o Iulai 1853.

- W. L. Lee
- G. M. Robertson
- S. H. Smith
- J. K. Kamao

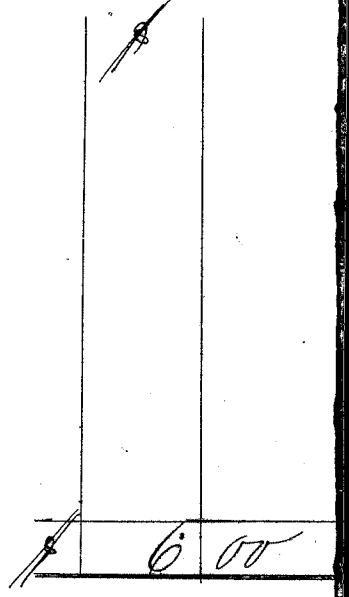

Oia ma palena. Anai o S. P. Kalama

Ana ma Kaolu Nuuanu Honolulu Oahu.

3 Loi me Sila. E hoomaka ma ka kiki Kema o keia aino e pili ana me ke kiki Komaana o ke Pikai no Smith a me ka papohaku o R. C. Nyllic, - a e holo Kema 26° 30' Hikina 92 Panku e pili ana me ke Pikai no Smith, - Alaila Kema 4° Kom. 33 Panku me ka Loi aupuni, - Alaila Kema 62° Kom. 163 Panku e pili ana me ka auwai a me kuana o Laanui no R. C. Nyllic, - Alaila Kema 38° 30' Kom. 166 Panku, - a me Kema 15° Hikina 21 Panku, - a me Kema 38° 30' Kom. 80 Panku e pili ana me Laanui no Nyllic a hiki i ka papohaku lili Kema o ke Alanui Nuuanu, - Alaila Kema 9° Kom. 242 Panku ma ka lili Kema o ke Alanui Nuuanu a hiki i ke kiki papohaku o Kale, Alaila Kema 60° Hikina 330 Panku ma ka papohaku o Kale a hiki i ka hoomaka ana.

Oia ka Ili

49/100 Eka

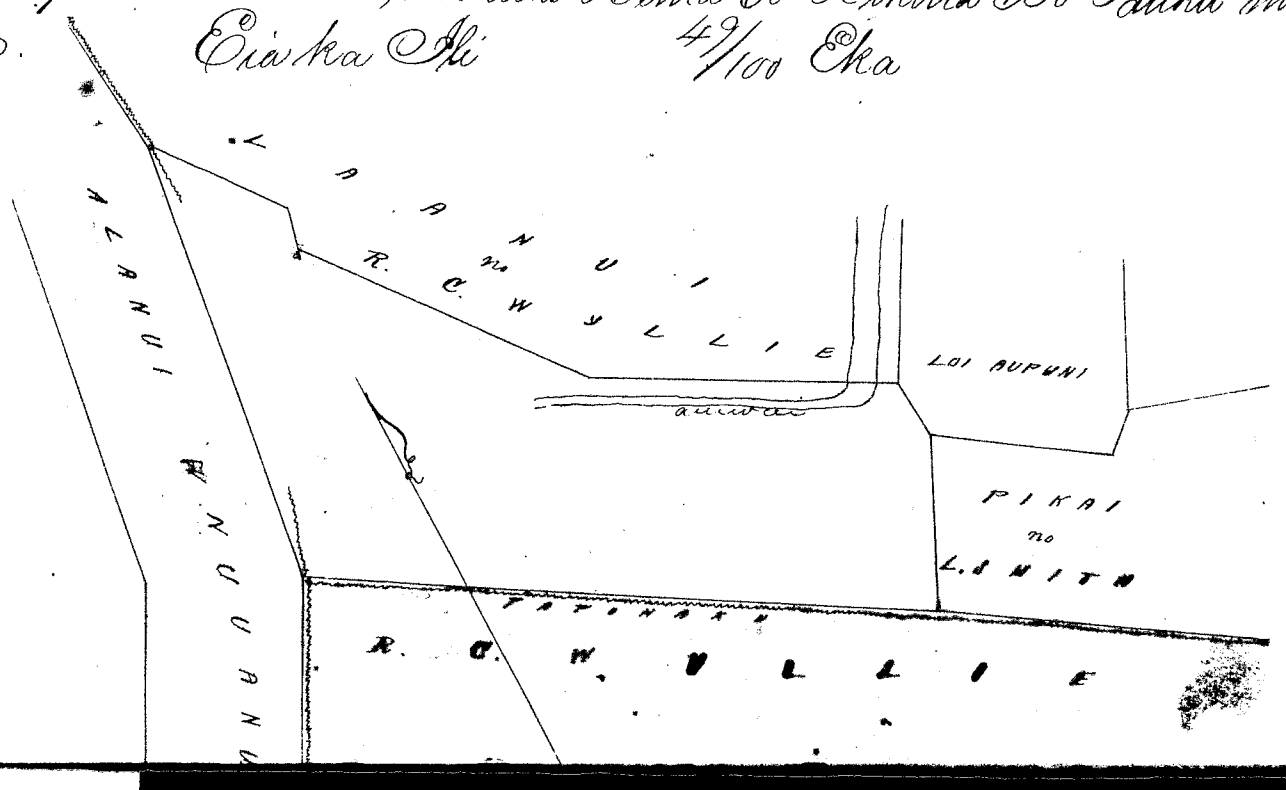

100 Panku = INCH SCALE

Helu 4890 Kuaiwa (no Kelikahilo)

Ua koi mai oia no kona Apiana aina ma ka Lela o Aipiaako ma Auuanu i Honolulu, ma Awa, ma ka Mokupuni o Oahu, no ka mea, ua hooia i keia wahi no Mahina mai kana kane mamua aku o ka make ana o Auahumanu i ka M. A. 1832, a ua hooia hoi ia Mahina no A. Auakini mai, a ua noho mau no o Kuaiwa ma keia wahi a hiki i kona make ana i ka makahiki 1848, hooili oia i keia wahi ia Kelikahilo kana kane hooi, a ke noho nei no o Kelikahilo malaila a hiki i keia manawa me ke keakea oleia.

Oia ka matou e hoko nei no Kuaiwa a ia Kelikahilo; he kuleana hoi kono malalo iho o ke Awa Alodi. Ina e uku mai oia iho ke Auuanu hapaha, alaila, ua kupo ia i keia ka Palapala Lila Alodi.

- Pono mau ia i ke uku no ka hooiolo a me ka hooiolo ana i ke olelo. Penei
- W. L. Lee No ka oomi a me ke pua ana i ke olelo ma ka Kupipua
 - G. M. Robertson No ke kope ana i ke olelo koina
 - J. H. Smith No ka palapala kii
 - J. H. Smith No ka hana ana i ke la 6 o Iune 1853.
 - J. H. Smith No ke kope ana i ke olelo a ma hiki 1/2 Awa
 - J. H. Smith No ke ana ana i ke la 22 o Iulai 1853. Uku ke ana \$6.
 - J. H. Smith No ke kope ana
 - J. H. Smith No ka hooiolo ana i ke olelo i ke la 23 o Iulai 1853.

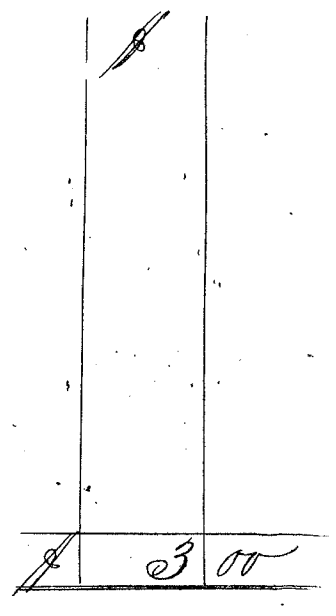

Oia na palena. Ina e J. P. Kalamo.

Aina ma Aipiaako Lela ma Auuanu Honolulu, Oahu.

7 Poi me Hale a me Kula Mahiai. E hoomaka ma kekahi Aka o keia aina, a e holo ana

Hema	45°	Kom.	264	Pauku e pili ana me Honohiki
"	38°	Hik.	106	"
"	30°	"	116	"
"	28 1/2°	"	97	"
Akau	59°	"	161	"
Hema	35°	"	64	"
"	61 1/2°	Kom.	162	"
"	51 1/2°	"	142	"
"	44°	Hik.	117	"
Akau	51 1/2°	"	461	Kalawalu & Lonaia & Hanakanui
"	37°	"	82	Hanakanui.
"	51°	Kom.	60	Isaka
Hema	47°	"	119	Honohiki
Akau.	47°	"	177	"
"	46°	Hik.	119	" a hiki i ke papohaku, Alaila holo ma ka papohaku a hiki i ke hoomaka ana.

Oia ka Ili 1/10 Eka.

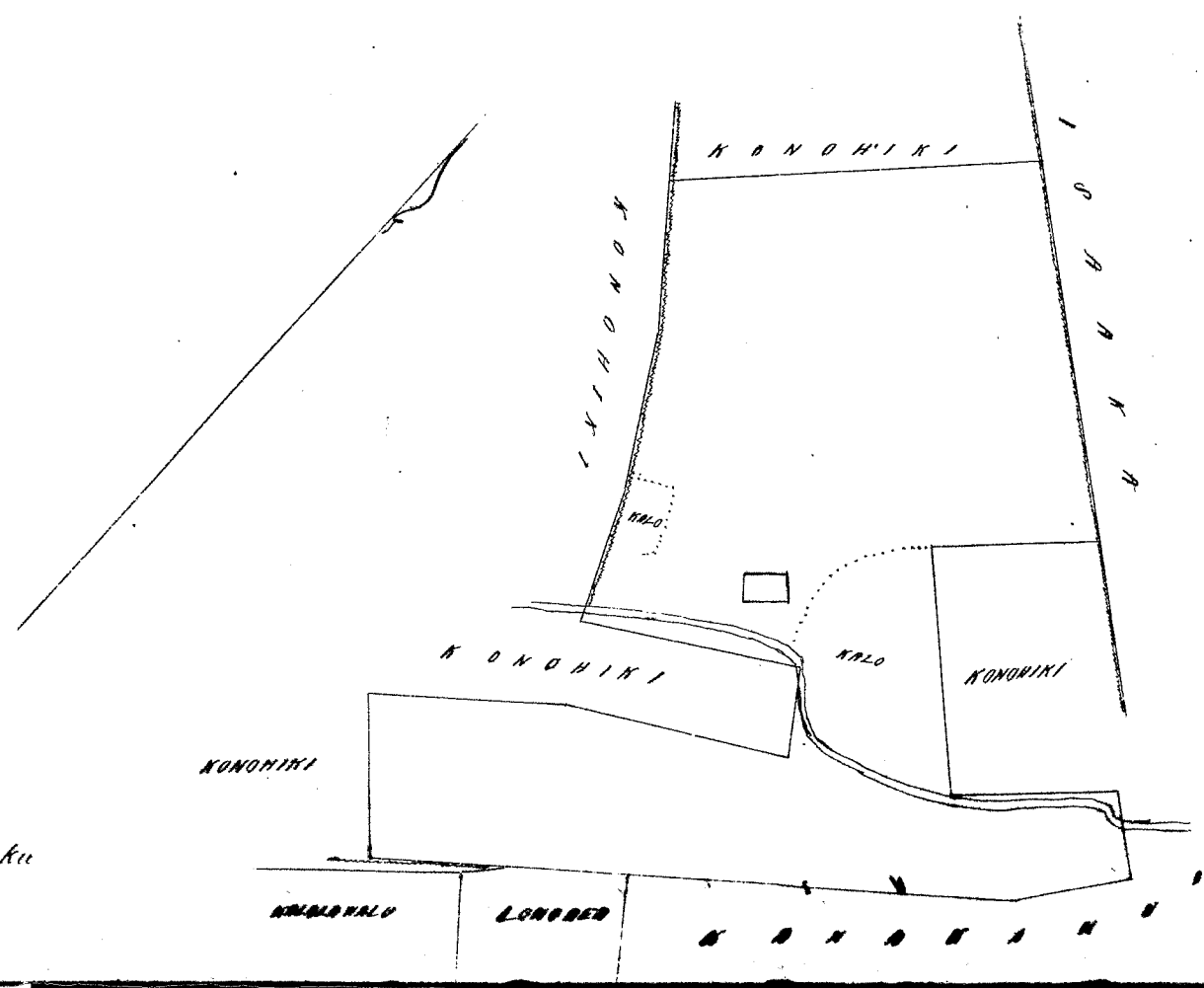

3/4 INCH = 100 FEET SCALE

Kelu 32 FL Kuneua

Ua hoi, mui oia no kona Apana aua, ma ka Ili o Kalia i Waikiki, ma Kona, ma ka Mokupuni o Oahu, e like me na Kanawai o ka makahiki 1851 no oia Aua Papua; ma ka mea, ua hooia ia i keia wahi no Kahuahine me mui i ka manawa e noho Kahuahine ana o J. H. Keating no Oahu me i ka makahiki 1831, a ua noho keakea ia a hiki i keia manawa.

Oia ka waihou a hooia me no Kuneua; hi huiamahiwi kona ma ke Aua Aloha. Pono na ia ia ke ika no ka hooihoholo a me ka hooihoholo ana i ka olelo. I mea:

- W. L. Lee No ka o-umi a me ke faai ana i ka olelo ma ka Kupuha
- G. M. Robertson No ke kopuana i ka olelo kimo.
- J. H. Smith No ka palapala hii
- J. H. Smith No ka hana ana i ka la 6 o Ianuari 1852.
- J. H. Smith No ke kope ana i ma olelo a ma hooike 1/4 aua
- J. H. Smith No ke ana ana i ka la 16 o Iulai 1853. Uka i ka ana \$6.00
- J. H. Smith No ke kope ana
- J. H. Smith No ka hooihoholo ana i ka olelo i ka la 28 o Iulai 1853.

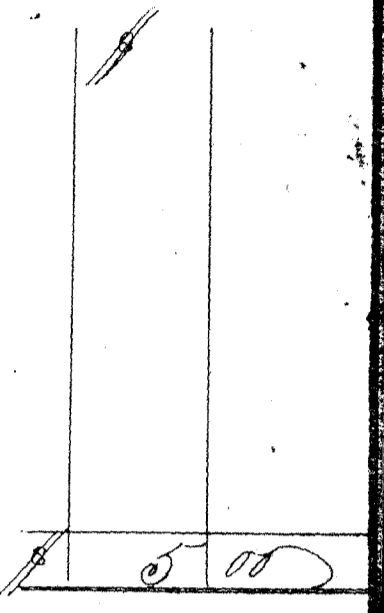

Oia na palena: Aua o J. P. Kalamo

Aua ma Kalia, Waikiki, Kona, Oahu.
 2 Loi, me 2 Paka, me 2 Kupuha. E hoomaka ma kekahi Maau o keia aua ma ka lili maikai o ke Alanui Honolulu e pili ana me kahi Kikinau Kama o ka Palena o Waikimalo, a e holo Kama 21 Kikinau 361 Paka ma ka lili aua maikai e ia alanui a hiki i ka aua o ke Aupuni, - Alaia Kama 46 Kom. 8 i Kaulahao, - a me Kama 46 Kikinau 202 Paka, kahi, - a me Kama 37 Kom. 4 i Kaulahao, kahi Kama o keia, - a me Maau 54 Kom. 304 Paka, kahi ma lili aua maikai, a me Maau 31 Kikinau 235 Paka, kekua ma lili aua maikai, a me Maau 57 Kom. 44 Paka, kahi lili Kama aua maikai, a me Maau 12 Kom. 184 Paka e pili ana me ka palena aua o ke Aupuni a hiki i ka lili aua maikai a hiki i ka aua maikai o ka Palena o Pahu no Iona, - Alaia holo i ka maikai lili o ia aua maikai, Maau 53 Kikinau 82 Paka, - a me Maau 67 Kikinau 248 Paka, a me Maau 53 Kom. 573 Paka a hiki i ka haku kokoke i ka maikai aua maikai, he 16 Paka i ka haku hema, - Alaia Maau 44 Kom. 573 Paka a hiki i ka haku kokoke o ka Palena o Waikimalo, - Alaia Maau 86 Kom. 230 Paka, - a me Kama 44 Kikinau 93 Paka, a me Maau 66 Kom. Kikinau ma 56 Paka me Waikimalo a hiki i ka hoomaka ana

Eia ka Ili 4 1/100 Eka.

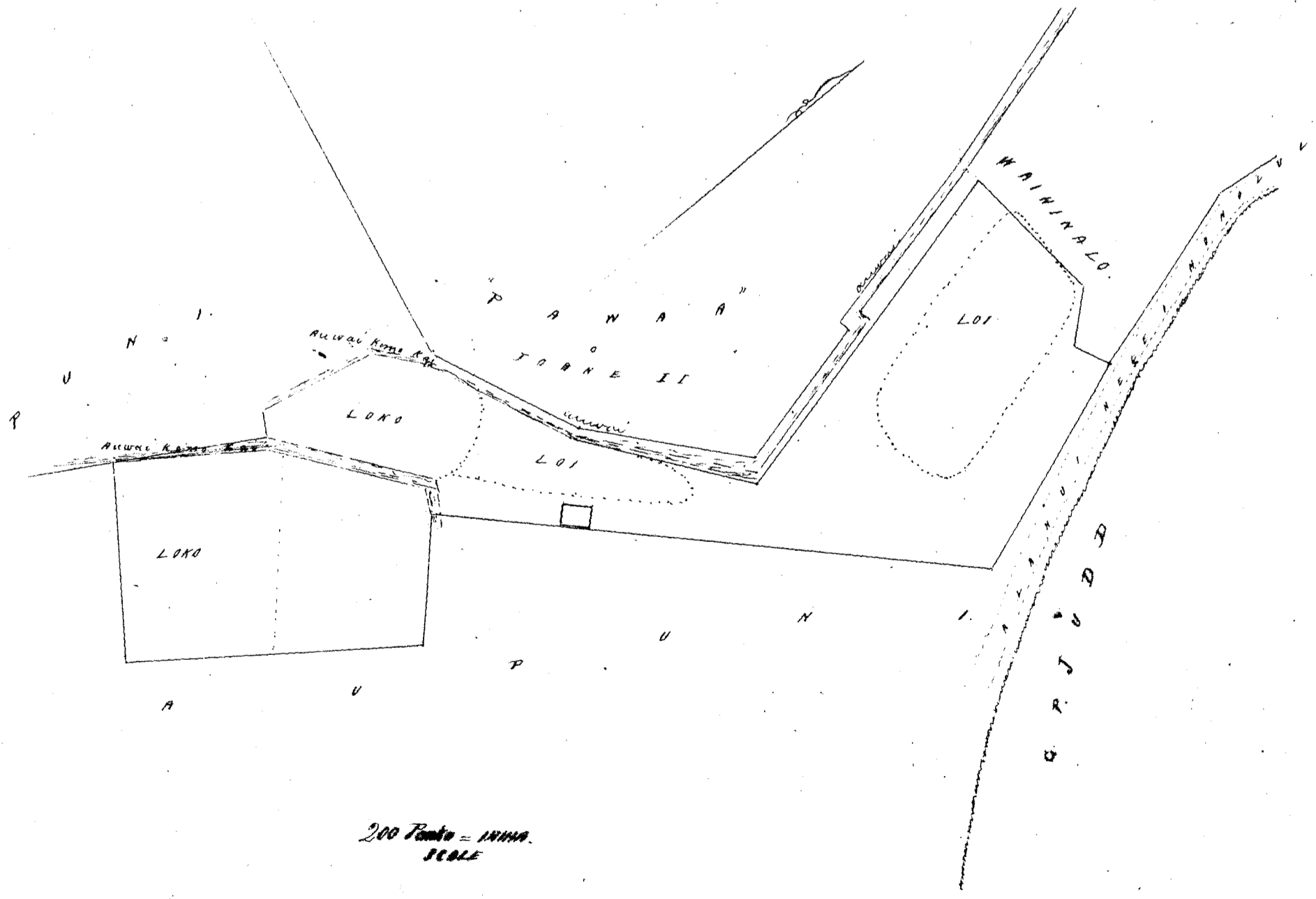

Helu 80 FL Kapau

Ua kōi mai oia no kona Pahale ma ka Iki o Kuwili i Honolulu, Oahu ma Kona, ma ka Mokupuni o Oahu, e like me na Kanawai o ka Makahiki 1851, no wa Aina Papu, no ka mea, ua loaa iaia keia wahi no Kanoho mai kona makuukane ika manawa e noho ana o S. A. Kukini ma ka Papu o Honolulu meia ka M.H. 1831, a ua noho keuea oia a hiki i keia manawa.

Oia ka makuu hōko nei no Kapau, he kuleana hoi kona matato iho o ke Awa Alodio. Ima e uku mai oia iko ke Aupuni hapahu; alaila, ua kupona iaia ka Palapala Sila Alodio.

- Pono mai ia ia ke uku no ka hōkolo kolo a me ka hōhōlo ana i ka olelo. Penei, -
- No ka rumi a me ke pahi ana i ka olelo ma ka Nupepa
 - No ke kope ana i ka olelo kōina
 - No ka palapala kii
 - No ka hana ana i ka la 31 o Maraki 1852.
 - No ke kope ana i ma olelo a ma hōke 1/2 Awa
 - No ke ana ana i ka la 20 o Aperila 1852. Ukuia ke ana \$4.00
 - No ke kope ana
 - No ka hōhōlo ana i ka olelo i ka la 28 o Iulai 1853.

\$	2 00

Oia ma palena. Aina o S. P. Kalama.

Pahale ma Kuwili, Honolulu, Oahu.

Ua hōmaka ma ke kiki (Kikina) o keia Pahale, ke kiki Maui o ka Pahale o Kahakawai, e pili ana me ke Kahawaiolaa, a e hōlo Maui 37° Nomi. 2 43/100 Kaula ma ka Kahawaiolaa a hiki iko ke Aupuni, - Alaila Kona 63° Nomi. 1 7/100 Kaula ma ka palena kula aupuni a hiki i ke kiki Kōmohana ma ka lili ma ka o Kūna ma ka Kahiko, - Alaila Kona 25° Niki. 2 66/100 Kaula ma ka Aupuni a hiki i ke kiki Kōmohana o ka Pahale o Kahakawai, - Alaila Maui 56° Niki. 2 45/100 Kaula ma ka Kahakawai a hiki i ka hiki i hōmaka'i.

Ma ia Pahale 56/100 Eka.

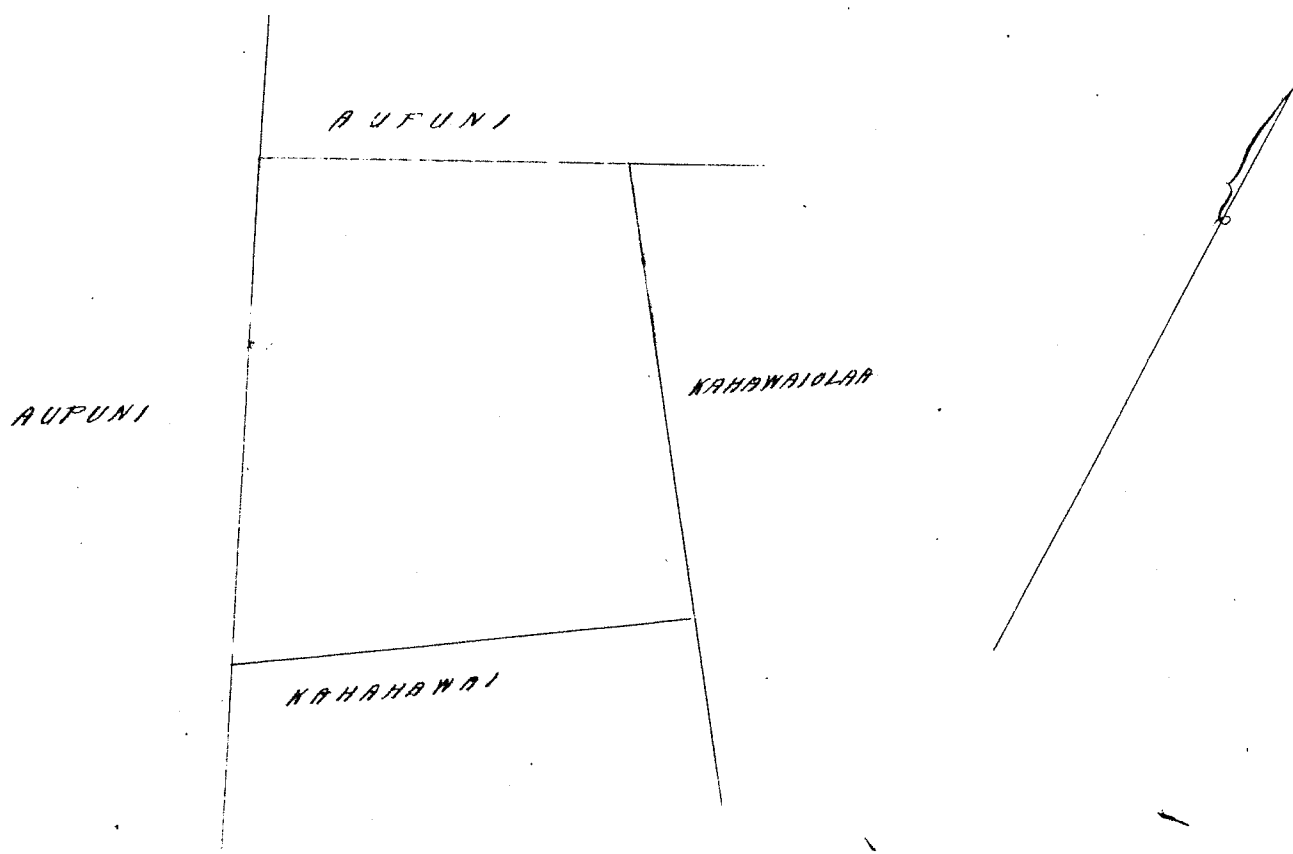

Helu 81 FL Kahawaiolaa

Ua kōi mai oia no kona Pahale ma ka Iki o Kuwili i Honolulu ma Kona, ma ka Mokupuni o Oahu, e like me na Kanawai o ka Makahiki 1851, no wa Aina Papu, no ka mea, ua loaa iaia keia wahi no Kōmohana mai ika wa o Kamehameha I, a ua noho keuea oia a hiki i keia manawa.

Oia ka makuu e hōko nei no Kahawaiolaa; he kuleana hoi kona matato iho o ke Awa Alodio. Ima e uku mai oia iko ke Aupuni hapahu; alaila, ua kupona iaia ka Palapala Sila Alodio.

- Pono mai ia ia ke uku no ka hōkolo kolo a me ka hōhōlo ana i ka olelo. Penei
- No ka rumi a me ke pahi ana i ka olelo ma ka Nupepa
 - No ke kope ana i ka olelo kōina
 - No ka palapala kii
 - No ka hana ana i ka la 31 o Maraki 1852.

\$	2 00

W. L. Lee
 G. M. Robertson No ke kope ana i ma olelo ana hoiko 1/3 Awar
 J. H. Smith No ke ana ana i ka la 20 o Aperila 1852. Ukuia ke ana \$6.00
 J. Kekaulahao No ke kope ana
 No ke hooholo ana i ka olelo i ka la 28 o Iulai 1853.

\$	3 00
----	------

Oia ma palena. Amia e S. P. Kalama.

Pahale ma Kuwili, Honolulu, Oahu.

E hoomaka ma ka pohaku x kokoke i ka pali Loko "Kawa", ke kiki Kema no ke Kuleana o Kalalilo, a e holo i ka Kawa 34 45' Kom. 3 46/100 Kaulahao e fili ana me ke Kalalilo a hiki i ke Aupuni, - Alaila Kema 63° Kom. 2 Kaulahao ma ka palena hula me Aupuni a hiki i ke kiki Kawa o ke Kapau Pahale, - Alaila Kema 57° Hik. 5 Kaulahao e fili ana me ke Kapau a me Kahawai a hiki i ka lwa Keia kokoke i ka Loko, - Alaila holo i ke a pumi i ka hiki i hoomaka i.

Maloko o keia Pahale 8/10 Eka.

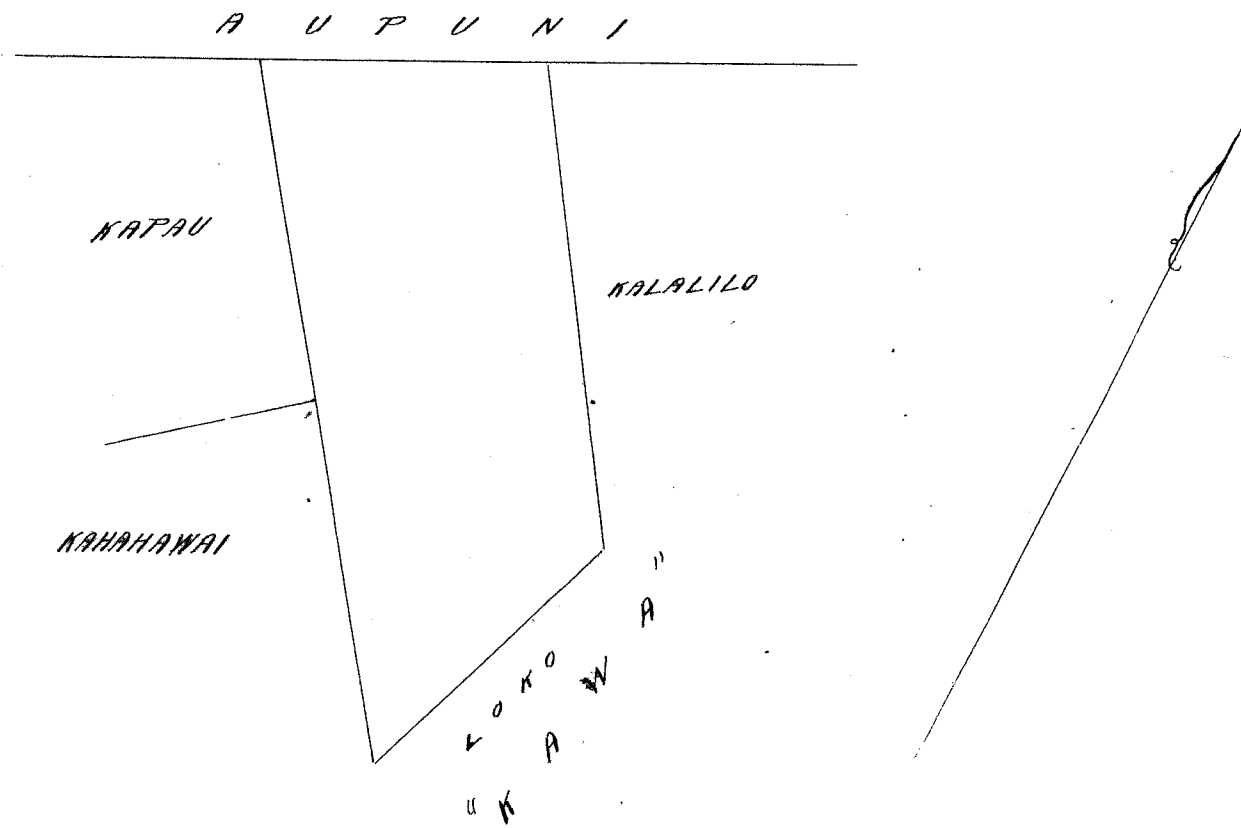

Helu 82 FL Keana I.

Ua hoi mai oia no kona Pahale ma ka Ali o Kuwili i Honolulu, ma Kona, ma ka Moku o Oahu a like me ma Kanawai o ka Makuhiki 1851, no wa Aina Pape, no ka mea ua loa iaia keia wahi no kona mau ma ka mai i ka wa o Hamahamaha I, a ua noho keakea oia a hiki i keia manawa.

Oia ka makou e hooke me no Keana, he kuleana hoi kona malalo iho o ke Awa Aloha. Ika e uka ma oia i ke ke Aupuni hapaha, alaila, ua kupaia ia ia ka Palapala Lila Aloha.

Tono ma iaia ke uku no ka hooholo ana i ma olelo ana i ka olelo Penei,
 W. L. Lee No ke rumi a me ke pui ana i ka olelo ma ka Mapepa
 G. M. Robertson No ke kope ana i ka olelo hoima
 No ke palapala hui
 J. H. Smith No ka hana ana i ka la 31 o Maraki 1852.
 J. Kekaulahao No ke kope ana i ma olelo a ma hoiko 1/3 Awar
 No ke ana ana i ka la 20 o Aperila 1852. Ukuia ke ana \$4.00
 No ke kope ana
 No ke hooholo ana i ka olelo i ka la 28 o Iulai 1853.

\$	2 00
----	------

Oia ma palena. Amia e S. P. Kalama.

Pahale ma Kuwili, Honolulu, Oahu.

E hoomaka ma ka pohaku faakea i Hoailonaia x ma ke kiki Bikina ma ka keia Pahale, ma ke kiki pali o ka Loko "Kawa" ka inoa, a e holo i ka Kawa 37° Kom. 2 1/100 Kaulahao ma ke Aupuni a hiki i ke kiki Kom. Ma keia, - Alaila Kema 63° Kom. 1 3/4 Kaulahao ma ke Aupuni a hiki i ke Kalalilo, - Alaila Kema 37° Hik. 2 3/100 Kaulahao ma ke Kalalilo a hiki i ka pohaku i Hoailonaia x ma ka faakea kokoke i ka Loko, - Malaila holo i ke a pumi i ka hiki i hoomaka i. Maloko o ia Pahale 33/100 Eka.

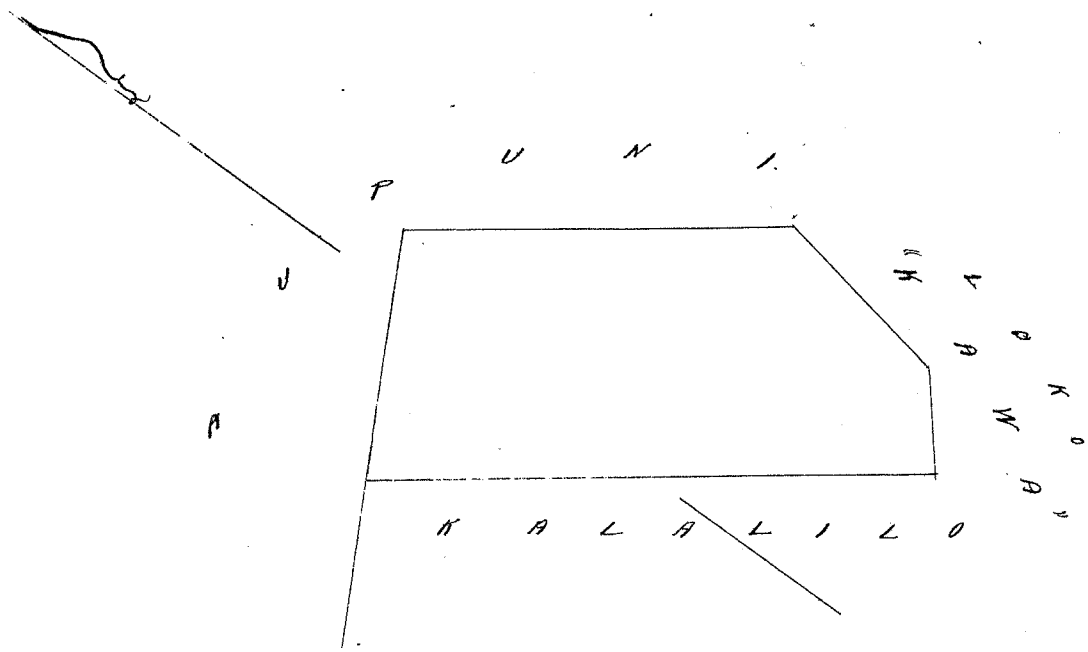

Hele 83 FL Kahakawai

Ua hoi mai oia no kona wahi Pahale ma ka Ii o Kuwiti i Honolulu, ma kona, ma ka Moku o Oahu, e like me na Kanawai o ka Makahiki 1851, no na Aina Papu; no ka mea, ua hooia ia i keia wahi no Mana mai ke Honolulu i ka wa o S. A. Kuatini e wahi ana ma ka Papu o Honolulu, a ua moho keakea oleia a hiki i keia manawa.

Oia ka moku e hooia mai no Kahakawai; he Kuleana hoi kona malalo iho o ke Ano Aloha. Ina e ukui mai oia i ke ke Aupuni Kapaha, alaila, ua kupaia ia ia i ka Palapala Lila Aloha.

Ua hooia ia ia ke ukui no ka hooia oleia a me ka hooia ana i ka olelo. Penei,

- W. L. Lee No ka rami u me ke hoi ana i ka olelo ma ka Muepua
- G. M. Robertson No ke hoi ana i ka olelo koina
- J. H. Smith No ka palapala hii
- J. Kaulahao No ka hana ana i ka Lu 31 o Maraki 1852.
- No ke hoi ana i ka olelo a na hoike 1/3 Aoa.
- No ke hana ana i ka Lu 20 o Aperila 1852.
- No ke hoi ana
- No ka hooia ana i ka olelo i ka Lu 28 o Iulai 1853.

\$	300

Oia na palena. Aina e S. P. Kaulahao.

Pahale, ma Kuwiti, Honolulu, Oahu.
 E hoomaka ma ka lina Keia kahiko kokoke i ka Loko "Kawa", a i holo Akau 37° Horn. 2 5/100 Kaulahao e pili ana me ke Kapau a hiki i ke Kapau, - Alaila Kema 56° Horn. 2 45/100 Kaulahao e pili ana me ke Kapau a hiki i ka lina ma ka Kahiko, - Alaila Kema 25° Hiki. 1 78/100 Kaulahao ma ka aina Aupuni a me Kema 63° Hiki. 1 42/100 Kaulahao, a me Akau 46° Hiki. 2 2/100 Kaulahao ma ke Aupuni a hiki i ka hiki i hoomaka i.
 Ma ia Pahale 1/10 Eka

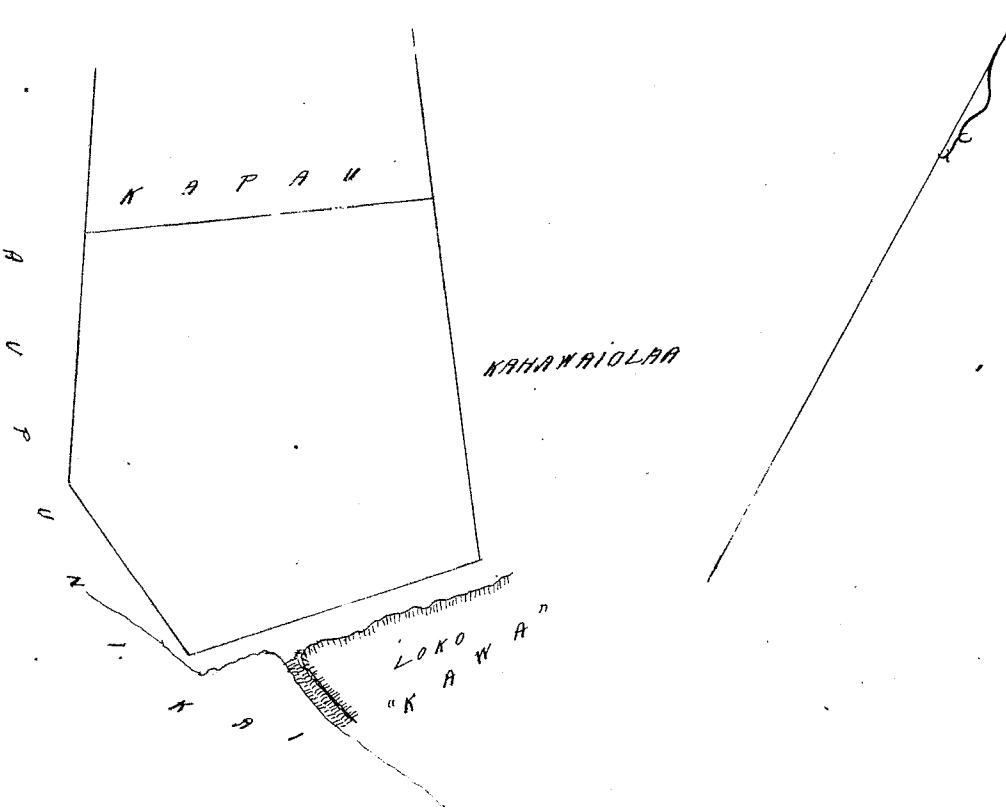

3/4 INHA = KAWAHAO

Helu 87 FL Kanehailua

Ua koi mai oia no kona Aina ma ka Ali o Kihimama i Honolulu, ma Kona, ma ka Mokupuni o Oahu, e like me na Kanawai o ka Makahiki 1851, no na Aina Pupu; no ka mea, ua lona ia ia keia wahi no Pine i ka wa e ola ana o Kekaulohi i ka M. A. 1840, a ua noho keakea oleia a hiki i keia manawa.

Oia ka makou e hoohe nei no Kanehailua; he kuleana hoi kona matato iho o ke Awo Alodio. Ina e uku mau oia i ke ke Aupuni kapahe; alaila, ua kuperono ia ia ka Palapala Lita Alodio.

Imo nani ia ia ke uku no ka hoohehoko a me ka hoohehe ana i ka olelo. Penei

- W. L. Lee No ka rumi a me ke pua ana i ka olelo ma ka Mupupa
- G. M. Robertson No ka kope ana i ka olelo koina
- J. H. Smith No ka palapala kii
- J. Kekaulaha No ka hana ana i ka la 27 o Iulai 1853.
- No ke kope ana i ma olelo a ma hiki 1/3 Awa
- No ke ananani i ka la 31 o Augate 1852. Ukuwa ke ana \$3.00
- No ka kope ana
- No ka hoohehe ana i ka olelo i ka la 28 o Iulai 1853.

2	00

Oia ma palena. Aniani i S. P. Kalamia.

Kuleana ma Kihimama Honolulu, Oahu,
 1 Loi. E hoomaka ma ka hiki Koomohana ma ka keia kuleana, e pili ana me ke Kihia a me ke Aupuni. A e holo i ka Heema 49. Hikiwa 2 ²⁹/₁₀₀ Kaulahas, pili ana me ke Aupuni, a i ka Heema 44 Hikiwa 1 ⁹⁰/₁₀₀ Kaulahas ma ka hiki Loi Aupuni a hiki i ke Koi. Alaila holo i ka Heema 47 ³/₄ Kom. 2 ²⁹/₁₀₀ Kaulahas ma ke Koi a hiki i ke Kihia. Alaila holo i ka Heema 44 Kom. 2 Kaulahas e walele ana i kaawale ke Kihia a hiki i keia manawa ma ka hiki i hoomaka i.

Kona Ali 423 Anana 28 Kapuwa.

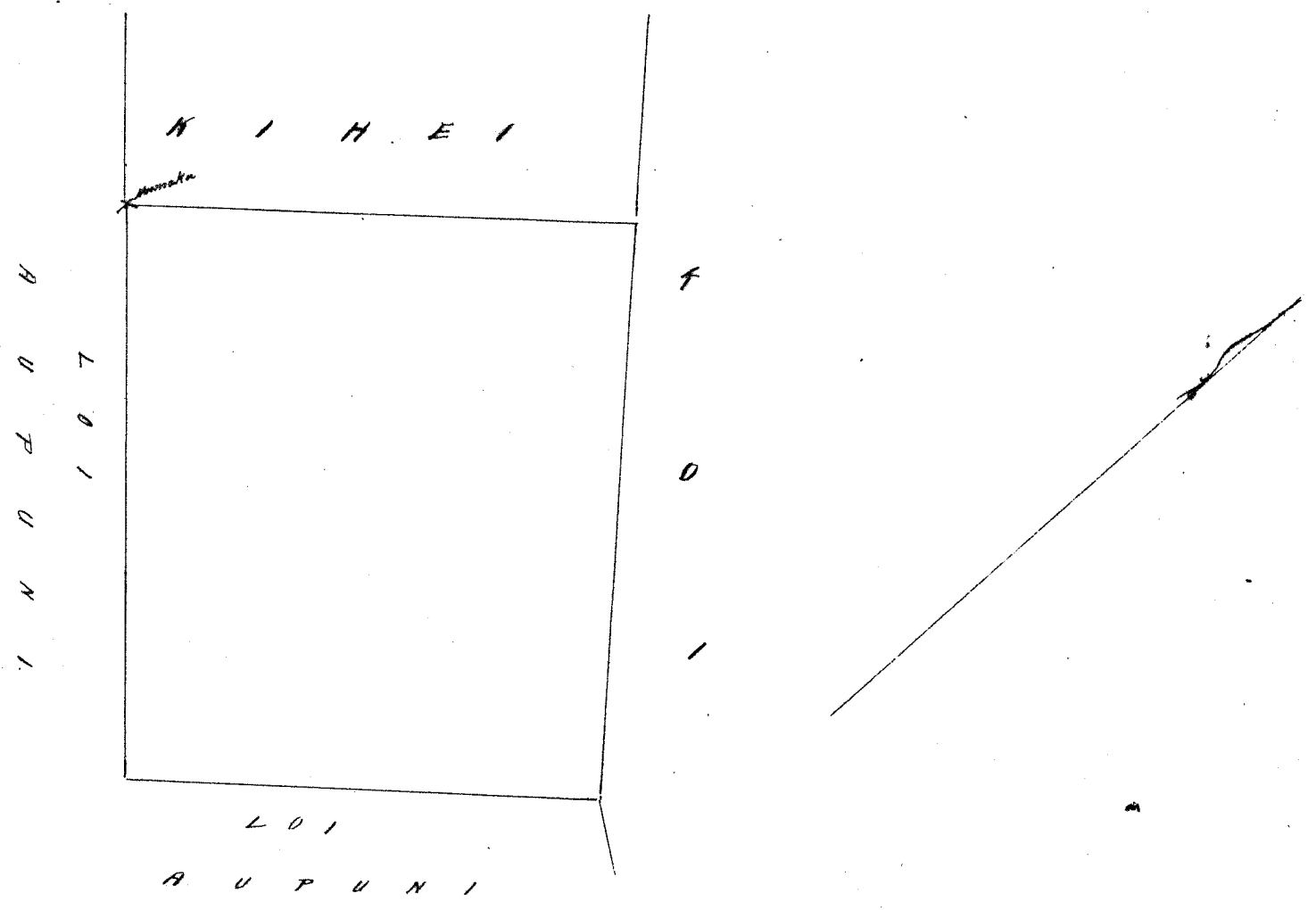

Helu 10218: 10221 L. Makaulia

Ua koi mai oia no kona Aina o Kaapuna, he Ahupuaa ia Kapalilua, ma Kona, ma ka Mokupuni o Hawaii; no ka mea, ua lona ia ia keia Aina no ke Alii Kamehameha III mai i ka wa o ka Mahela ana i na Aina i ka M. A. 1848, a ua noho keakea oleia a hiki i keia manawa.

Oia ka makou e hoohe nei no L. Makaulia; he kuleana hoi kona matato iho o ke Awo Alodio. Ina e uku mai oia i ke ke Aupuni kapahe; alaila, ua kuperono ia ia ka Palapala Lita Alodio.

Imo nani ia ia ke uku no ka hoohehoko a me ka hoohehe ana i ka olelo. Penei

- No ka rumi a me ke pua ana i ka olelo ma ka Mupupa
- No ka kope ana i ka olelo koina
- No ka palapala kii

--	--

W. L. Lee
G. M. Robertson
J. H. Smith
J. Kekaulaha

No ka hana ana i ka la
No ke kope ana i na olelo a ma hoiho
No ke anu ana i ka la
No ke kope ana
No ka hooholo ana i ka olelo i ka la 29 o Iulai 1853.

110

Ua hooke aku makou i keia kuleana aina mamuli o wa olelo o ke Kanawai hou i hooholoia ma ka la 19 o Iuni M.H. 1851, e pili ana i na honohiki. Koe wae na kuleana aina o wa Kanaka maloko o keia aina.

Helu 3454. Keuwa.

Kanawai

Ua kai mai oia i kona Apana aina ma Kaala, Kuwani, Honolulu, Oahu, no ka mea, wa hana ia ia keia Apana ma Kaitimetele mai i ka wa o Kaiakumahu i. mawana aku o ke kaa ana o wa Kanawai, a wa noho ka akua ole ia a hiki i keia manawa.

Oia ka makou i hooke nei no Keuwa ke kule ana hoi kama malalo iho o ke ano Ua dio. Ina ikeu mai oia i ke ke Aupuni hapaha, abaha, wa kupuni ia ia ke palapala Sila Ua dio.

Ua wae ia ia ke ikeu ana no ka hooholo a me ka hooholo ana i ka olelo. Peni;

W. L. Lee
G. M. Robertson
J. Kekaulaha
J. H. Smith

No ka auni a me ke pui ana i ka olelo ma ke Aupuni.
No ke kope ana i na olelo keiwa 1/2 ana
No ka palapala hii
No ka hana ana i ka la 22, o Nov. 1850.
No ke kope ana i na olelo hiki 1/3 ana
No ke ana ana i ka la 18, o Mar. 1852. Ua kaa \$3.00
No ke kope ana.
No ka hooholo ana i ka olelo i ka la 1, o Augate 1853.

Peni ma palawa.

Anaia S. P. Kalama.

\$ 3.00

I kei one kula. E hoomaka ma ke kiki Kona, o kea Loi ma ke hooana + iwaena o ke Ala olelo Apana Aina Aupuni. Ue holo. Akau 4 1/2 f. Hiki: 96 Panku, Ala olelo ma Katalawalu. Ke. 3 1/2 f. Hiki: 145 Panku. Katalawalu. Ak. 2 1/2 f. Hiki: 130 Panku, Alamui Kuwani, Ak. 26 f. Kona: 180 Panku, Aina o Kanawalu. Heema 53 f. Kona: 76 Panku, Aina o Lonoaea. Ak. 35 1/2 f. Kona: 110 Panku, Lonoaea. Ak. 88 f. Kona: 27 Panku, Lonoaea. Ke. 52 f. Kona: 75 Panku Katalawalu. Ke. 30 1/2 f. Hiki: 26 Panku, Katalawalu. Ke. 54 f. Kona: 79 Panku Katalawalu a hiki i kea paha ana i hooanaia + ma ke kiki Heema o kea hoi o Katalawalu, Abaha 280 Panku a hoo paha ana me kea Apana Aina o ke Aupuni a hiki i kea hoomaka ana.

Oia ka Ili 5 1/2 f. Eka.

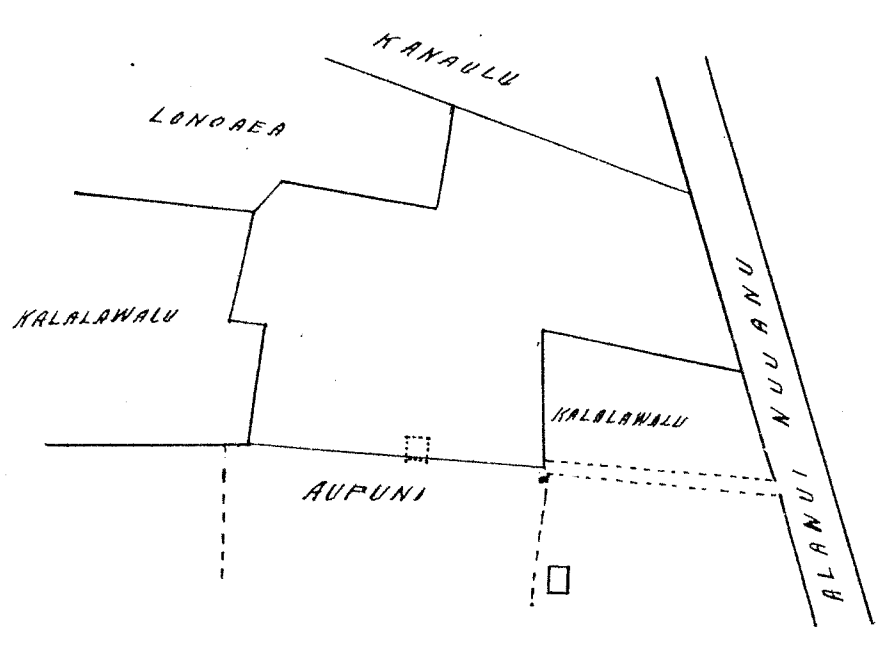

1/2 INCH = 100 PANKU
SCALE

Heleu 26 FL. Katalawalu

Kawana... (faint)

Ua koi mai oia i kona mau Apiana aina ma: Eadw, Kuwanu, Honolulu, Oahu. no ka mea wa lwa ia ia keia aina ma No. Hekuanara mai i ka Makahiki 1841 i ka wa o No. Hekaulohi ke Kubina, a ua mo- ho keakea oia a hiki i keia manawa.

Oia ka makou i hooke nei no Katalawalu, he kuleana hiki kona ma ka ke ano Alodiu. Ima eken mai oia i ke ke Aupuni hapaha, abaila, kufono ia ia ka Palapala Sila Alodiu.

Ima mai ia ia ke utu mai mo ka hohokole ana a me ka hohokole ana i ka olele Penei;

No ka oumi a me ke pua ana i ka olele ma ka Kupupa.

No ke kope ana i ma olele koma 1/2 araa.

No ka palapala kei.

No ka hana ana i ka la 29, o Iako. 1851

No ke kope ana i ma olele hoke 1 araa

No ke ana ana i ka la 18, o Maraki 1852.

No ke kope ana

No ka hohokole ana i ka olele i ka la 1, o Iuly. 1853.

W. L. Lee

G. M. Robertson

J. St. Smith

J. Hekaulaha

Penei oia palama.

Anaia o S. P. Kalamia.

5

Apiana 1. 1 Loi. E hoomaka ma ke hiki Koma i pili ana me ke Manui Kuwanu, a me ke ala olele Apiana aina Aupuni; Ala holo Ak. 28 30' Hiko: 77 Pautu me ke Manui Kuwanu, - abaila Ak. 22 30' Kom: 145 Pautu, - a me Ke. 43 30' Kom: 92 Pautu i pili ana me Kuawe, - abaila Ak. 41 30' Hiko: 166 Pautu, i pili ana me ke Ala olele a hiki i ka hoomaka ana. Eia ka Iki 12/100 Eka.

Apiana 2. 1 Loi me Kula.

E hoomaka ma ke hiki Kom: i pili ana me Kalino, a e holo Ke. 47 Hiko: 306 Pautu me Kalino me Aupuni a hiki i ka paha X ma ke hiki Koma i ka Loi. Abaila Ak. 54 Hiko: 79 Pautu, a me Ak. 30 30' Kom: 26 Pautu, a me Ak. 57 Hiko: 75 Pautu, i pili ana me Kuawe, - abaila Ak. 36 Kom: 3 kaulaha me Louoa, abaila Kom: 50 Kom: 219 Pautu me ka aina o Kuawia, Karama Ioane Ii. a hiki i ka hiki i hoomaka ia. Eia ka Iki 57/100 Eka.

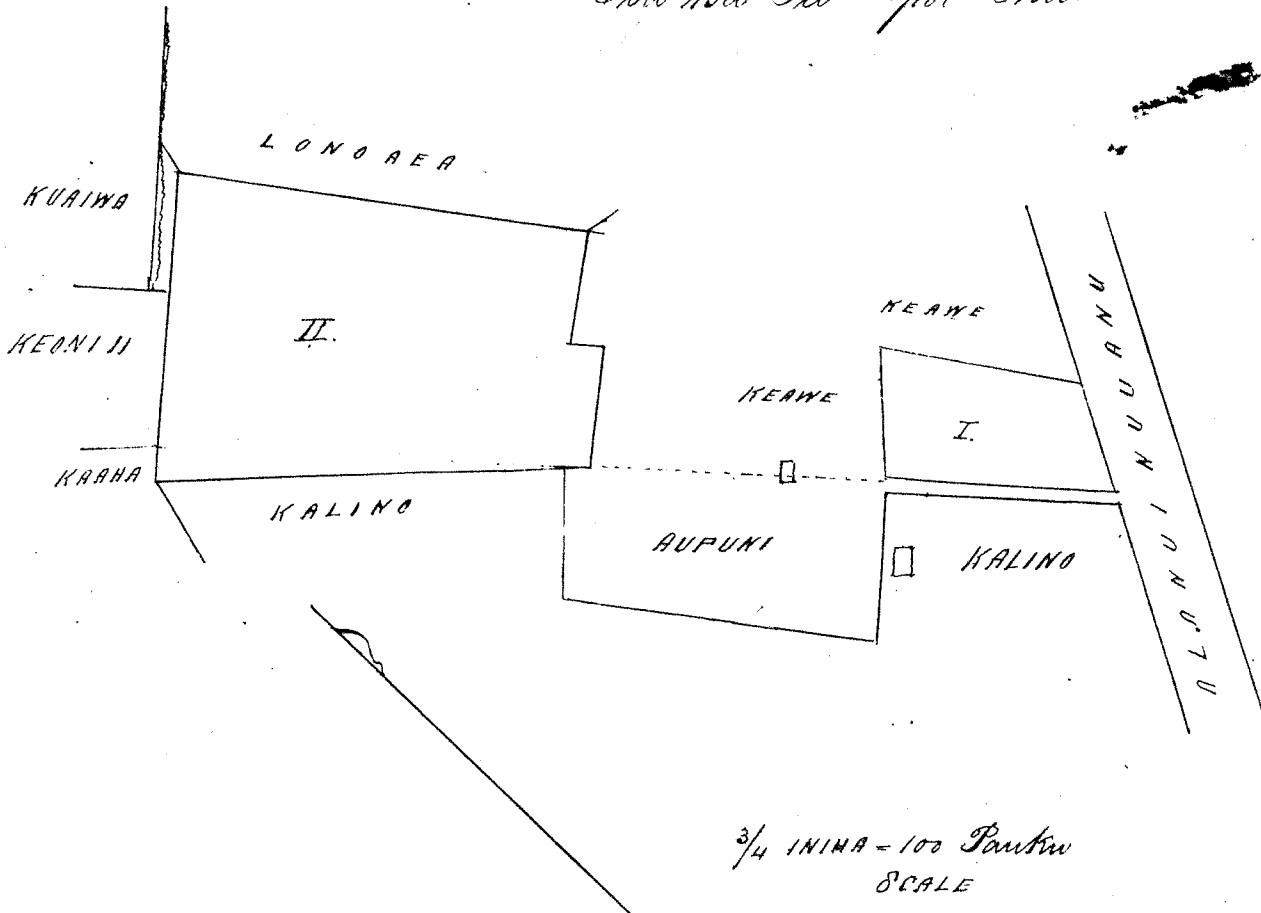

Heleu 26 FL. Katalawalu

Ua koi mai oia i kona mau Apiana aina ma: Katalawalu, Waikiki, Kona, Oahu, no ka mea, wa lwa ia ia keia aina ma No. Hekuanara mai i ka Makahiki 1841 i ka wa o No. Hekaulohi ke Kubina, a ua mo ho keakea oia a hiki i keia manawa.

Oia ka makou i hooke nei no Katalawalu he kuleana hiki kona ma ke ano Alodiu.

Ima mai ia ia ke utu mai mo ka hohokole ana a me ka hohokole ana i ka olele Penei;

No ka oumi a me ke pua ana i ka olele ma ka Kupupa.

No ke kope ana i ma olele koma 1/2 araa.

No ka palapala kei

No ka hana ana i ka la 29, o Iako. 1851.

W. L. Lee
G. M. Robertson
J. Kikaulaha
J. H. Smith

No ke kope ana i ma ole hiki 1 aoo
No ke ana ana i ka la 12, o Februari 1853. Ua kaa \$3.00
No ke kope ana
No ka hohole ana i ka ole i ka la 1, o Aug. 1853.

Puni ma palena.
Ania i S. J. Kalama.

\$ 4.00

Apana 3. 2 Loi. E hoomaka ma ke kiki Nema o keia Apana aina, ma ke kiki Nema o keia auwai ma keia kuauna o "Kapeaihu" Noke Aupuni. A e aku i ka Apana 24' Hiki: 122 Puntū, a me Apana 10'30' Kom: 149 Puntū ma ke kiki Nema o keia auwai me "Kapeaihu", Alaila Apana 84' Kom: 2 kaulaha me keia auwai e pui ana i keia, a e hiki ana ma ke kiki makai o keia auwai Komohana iwaena o keia me "Kamukuaula" o Aupuni ia Mahuka, - alaila Nema 6'30' Kom: 219 Puntū e pili ana me "Kamukuaula", - alaila Nema 73'30' Hiki: 211 Puntū e pili ana me keia auwai o Hawaii o hiki i keia hoomaka ana. Ika Iki 7/100 Eka.

Apana 4. 1 Loi. E hoomaka ma ke kiki Nema, a e ana Apana 26' Hiki: 331 Puntū, e pili ana me "Kekuaia" - wahi, Waa o me "Namaile", - alaila Apana 61' Kom: 241 Puntū e pili ana me "Kanaia", alaila Nema 24' Kom: 306 Puntū, me "Kamukuaula", alaila Nema 54' Hiki: ma kuauna o "Kamalua" Noke Aupuni a hiki i ka hoomaka ana. Ika Iki 7/100 Eka.

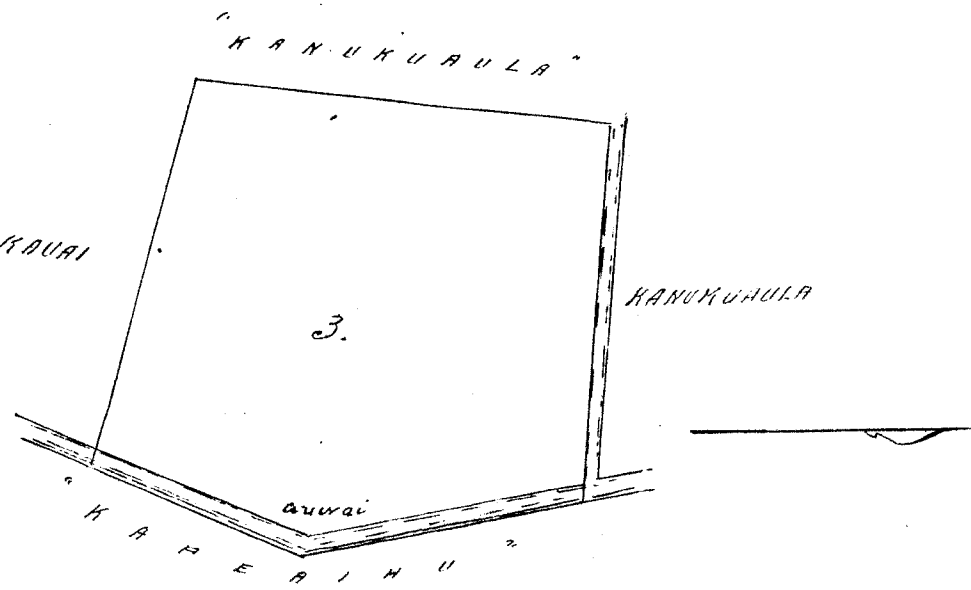
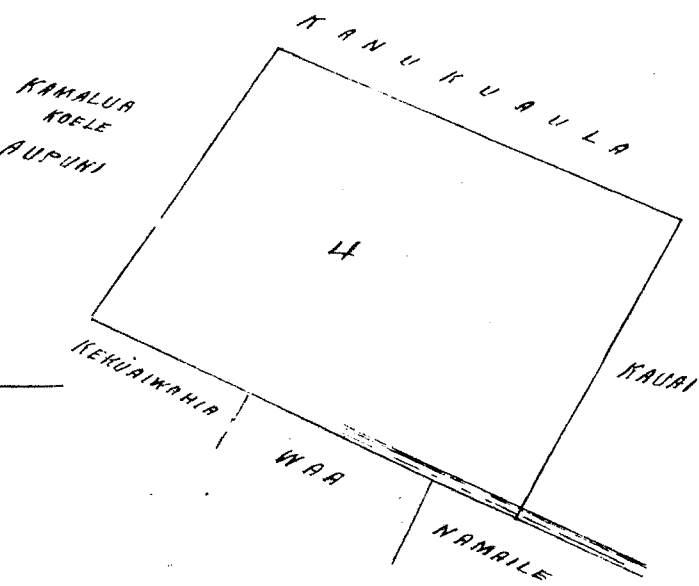

Hele 2553 A. Waiakea (me J. Kikaulaha)

Ua hui mai oia me kona mau Apana aina ma Olohu, Honolulu Aina, Oahu. I ka mea a hooia ia i keia Aina me Paahana kama kama i ka M. H. 1841, a me hooia Paahana kama kama me J. Kikaulaha ma i ka M. H. 1851, a me hooia o Paahana malaila a hiki i kona make ana i ka M. H. 1841, hooia me Apana Waiakea kama wahi, a me hooia ma malaila a hiki i kona make ana i ka M. H. 1849, hooia me Helele kama kama ma oia ia me keia olohu a hiki i kona wa i hoolilo aku ai i o J. Kikaulaha ma ka la 6, o Dekemaba 1851, a ia ia me a hiki i keia manawa, aole me keia.

Oia ka meke e hooia me A. Waiakea, a ia J. Kikaulaha, he kama hui kama malaila o keia olohu. Ika uki mai oia i ka ke Aupuni hooia, alaila, kope ia ia ka Palapala Ika Olohu.

W. L. Lee
G. M. Robertson
J. H. Smith
J. Kikaulaha

Puni ma palena
No ke kope ana i ma ole hiki 1 aoo
No ke kope ana i ma ole hiki 1 aoo
No ke kope ana i ma ole hiki 1 aoo
No ke ana ana i ka la 13, o Dekemaba 1851. Kaa \$5.00
No ke kope ana
No ka hohole ana i ka ole i ka la 1, o Aug. 1853.

Puni ma palena
Ania i S. J. Kalama

\$ 5.00

Apana 1. Kahuahala a me Kula Mahiai.
E hoomaka ma ke kiki Nema o keia Apana aina, e pili ana me keia aina o Hawaii, a e hiki Apana 41' Hiki: 4 kaulaha 13 Puntū e pili ana me Hawaii a me Kanaia a hiki i ka piliaku x ma ke kiki

maka'i o ke Alanui e holo ana i ka hiki o Kaunika Judd. - Alaila Akau 54° Kom: 2 kaulahao 70 Pautu ma ka hiki ma-
 -kai o ke Alanui a hiki i ka aia o Namai, alaila Nema 43½ Kom: 4 kaulahao 36 Pautu e pili ana me ke Namai
 a hiki i ke ke Aupuni maloko o ka pa puaa, alaila, Nema 52° Hiki: 2 kaulahao 92 Pautu e pili ana me ke Aupuni a
 hiki i ka hoomaka ana. *Kei kei 1 24/100 Eka.*

Apana 2. 9 Loo. E hoomaka ma ke hiki Hikiina o keia Apana aia e pili ana me ke hiki Nema o ke aia
 o kei ma ka hiki Akau o ke Alanui Liliha. A e holo Akau 52° 30' Kom: 2 kaulahao 82 Pautu e pili ana me
 Kei a hiki i ke pa puaa ana maka e holo ai ka wai, alaila Nema 38° Kom: 1 kaulahao 36 Pautu ma ka hiki
 Nema o ke Aupuni aia o keia me ke hiki o Lolo a hiki i ke Kanau; - Alaila meene kupuna Lima Nema 6 Pautu,
 keekee, a me Nema 38° Kom: 76 Pautu, - a me Nema 57° 30' Hikiina 121 Pautu, - a me Nema 36° 30' Kom: 3 kaulahao
 20 Pautu e pili ana me Kanau a hiki i ke aia o Kaunika Judd, alaila, Nema 58° Hikiina 1 ma 45 Pautu meene Lima
 Akau ke ke Pautu e pili ana me ke Aupuni Kaunika Judd a hiki i ke Alanui Liliha, - Alaila Akau 39° Hiki: 5 kaulahao ma
 ka hiki Kaulahao o ke Alanui Liliha a hiki i ka hoomaka ana. *Kei kei 1 3/100 Eka.*

Puu loa 2 27/100 Eka.

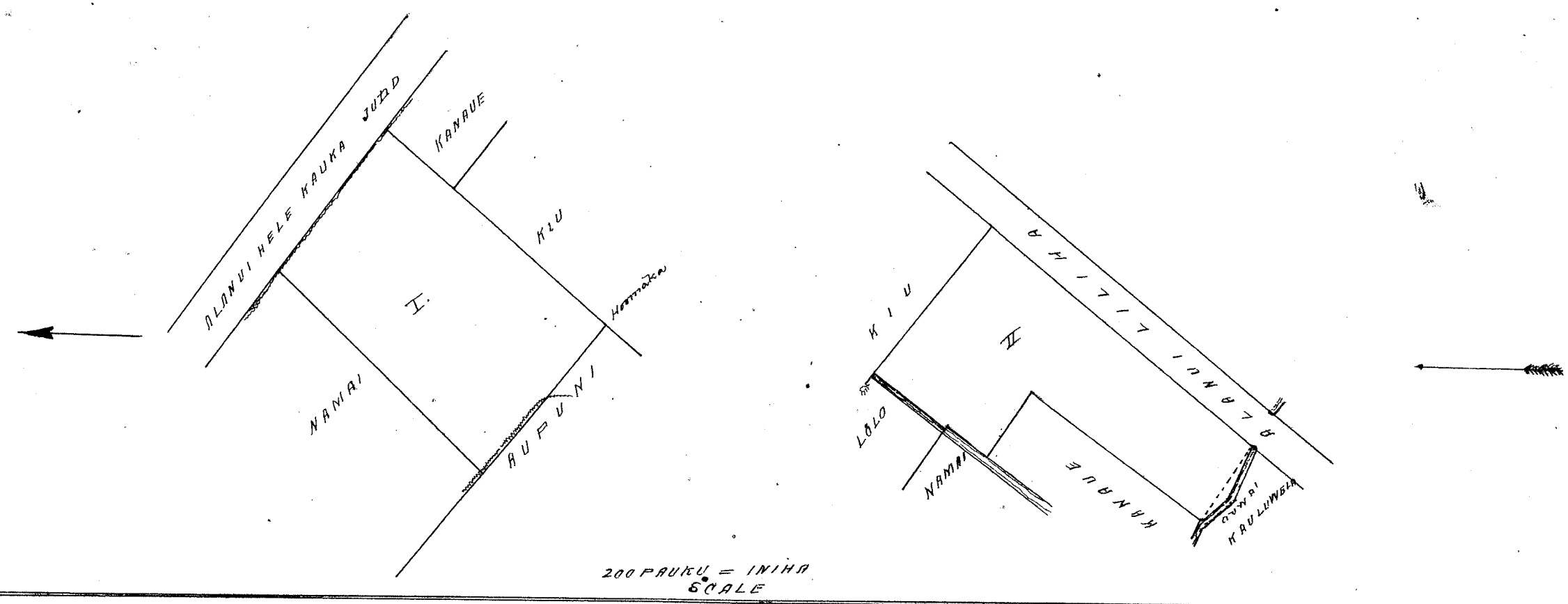

Hulu 51 FL. Suu

Royal Patent
 690

Ua hoi mai oia i kona mau Apana aia ma Oahu, Honolulu aia, Oahu. i lilo me nei Kanawai
 o ka M. A. 1851 ma ma Aia Papu, ma ka mea; ua hoi ia ia keia mau Apana aia ma Paahana mai i ka
 wa e ola ana o Hinan, a ua moho keakea oleia a hiki i kaia manawa i make ai hoili no kana mau keiki.

Oia ka maika e hooke nei no kei he keikiana hoi kona malalo iho o ke ano Alodio. Ina ike
 mai oia i ke ke Aupuni hapaaka, alaila, kupuna ia ia ka palapala Sila Nui Alodio.

Pono mai ia ia ke ike wai i ke hookeoleole a me ke hookeole ana i ke olele - Peni;

- M. L. Lee*
- G. M. Robertson*
- H. Smith*
- J. Kaulahao*

- No ke kumu a me ke puaa ana i ke olele mau ka Nupua.*
- No ke kope ana i ma olele keia.*
- No ke palapala kei.*
- No ke hana ana ma ka la 24. o Februari 1852.*
- No ke kope ana i ma olele hiki 1/2 Awa.*
- No ke ana ana i ka la 18, o Iulai 1853.*
- No ke kope ana.*
- No ke hookeole ana i ke olele i ka la 1. o Augato 1853.*

Peni ma palana

Anaia e S. P. Kalamo.

9.00

Apana 1. Kulu a me Kahakala.

E hoomaka ma ke hiki Akau o keia Apana aia e pili ana me ke palana o S. Kaulahao a me
 Kanau, - A e ana i ka Nema 53° Hikiina 136 Pautu me Kanau, alaila, Nema 40° 30' Kom: 416 Pautu e pili ana
 me ke aia o Kaunika Judd, alaila Akau 54° Kom: 142 Pautu, hiki a me Akau 41° Hikiina 423 Pautu me Au-
 -puni a me S. Kaulahao a hiki i ka hoomaka ana. *Kei kei 59/100 Eka.*

Apana 2. 8 Loo.

E hoomaka ma ke hiki Hikiina ma ka hiki Akau o ke Alanui Liliha, A e ana i ka Nema

39° Kom: 375 Pautu me ke Alanui. Liliha, alaila, Akau 52°30' Kom: 310 Pautu me J. Kekaulahao a me Lolo, alaila Akau 37° Nihina 320 Pautu me Namai a me ke Aupuni a hiki i kea pohaku, - alaila Nema 61°30' Nihina 330 Pautu me Aupuni a hiki i kea hoomaka ana. Eia kea Ii 1¹²/₁₀₀ Eka.

Tau loa 1⁷¹/₁₀₀ Eka.

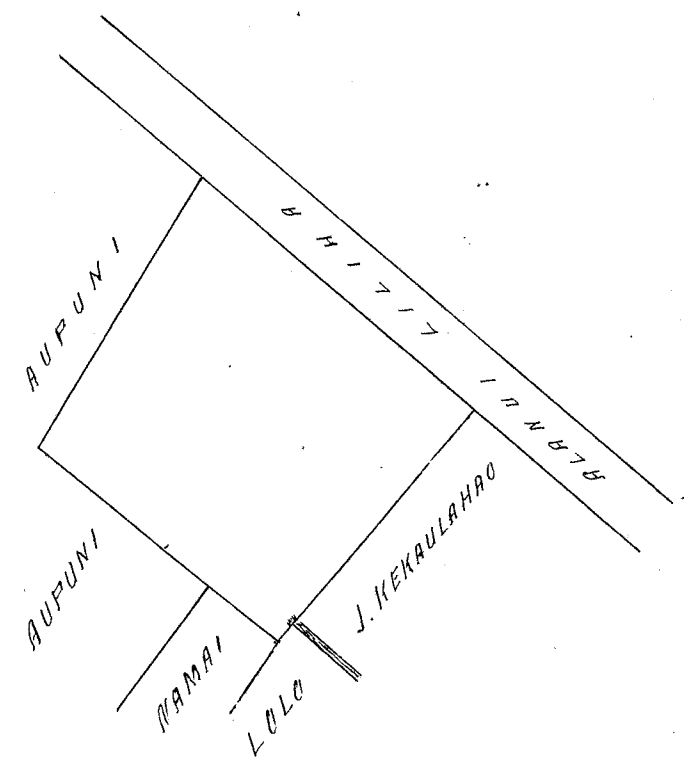
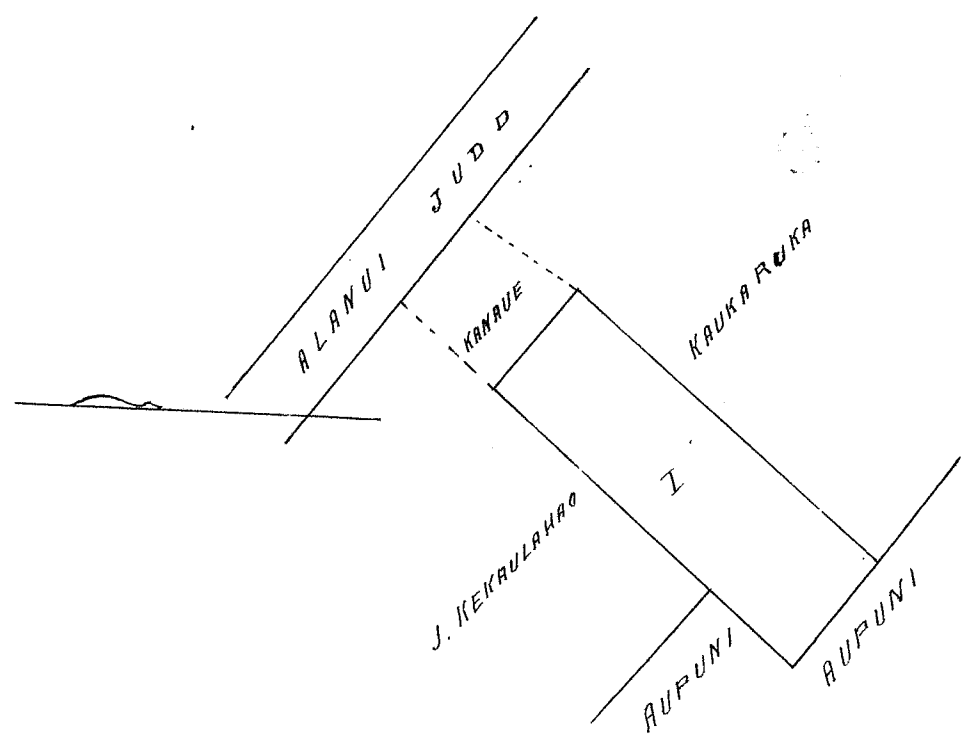

Hulu 55 FL. Kanau.

Ua hoi mai oia i kona mau Apana aina ma Oloku, Honolulu aina, i hiki me ma Komawai o kea (M. A. 1851) me ma Aina Tapa, no kea mea, ua loa ia ia no Pahana mai i kea wa e la ana o Hinai, a ua moho keakea ole ia a hiki i kea manawa.

Oia kea makua i hooke me no Kanau, he kuleana hoi kona malalo iho o kea Ano Alodio. Ima e ukua mai oia i kea ke Aupuni hapaha, alaila kupaia ia ia kea palapala Sila Nui Alodio.

Pono mai ia ia kea ukua mai no kea hookeole a me kea hookeole ana i kea olele - Penei,

N. L. Lee
G. M. Robertson
J. H. Smith
J. Kekaulahao

No kea auni a me kea pua ana i kea olele ma kea Nupia.
No kea kope ana i ma olele koina.
No kea palapala hii.
No kea hana ana i kea la 10, o Maraki 1852.
No kea kope ana i ma olele hoi kea 1/2 ana
No kea ana ana i kea la 18, o Subai 1853.
No kea kope ana
No kea hookeole ana i kea olele i kea la 1, o Augate 1853.

Penei ma palena.

Anaia e S. P. Kalama.

\$ 7.00

Apana 1. Kahmahale.

E hoomaka mai kea pohaku + hiki Nihina o kea aina o Kekaulahao me kea hiki makua o ke Alanui Judd. - A e holo Nema 41° Kom: 137 Pautu me J. Kekaulahao, - Alaila Nema 53° Nihina 136 Pautu e pili ana me Ii, - Alaila Akau 33°30' Nihina 139 Pautu e pili ana me kea aina o Kaula Puka, alaila Akau 53° Kom: 117 Pautu ma kea hiki makua o ke Alanui Judd a hiki i kea hoomaka ana. Eia kea Ii 212 Anana.

Apana 2. 6 Lii me Auwai.

E hoomaka mai kea hiki makua o kea aina o J. Kekaulahao, a e holo Nema 38° Kom: 76 Pautu, - a me Akau 57°30' Nihina 121 Pautu, a me Nema 36°30' Kom: 3 kaulahao 20 Pautu e pili ana me J. Kekaulahao, alaila Nema 1° Kom: 25 Pautu e moho ana i kea auwai a hiki i kea hiki Nihina o ke kuleana o Kalou, - alaila Akau 60° Kom: 198 Pautu, a me Akau 22° Kom: 52 Pautu ma kea hiki Nema o kea Auwai a hiki i kea pohaku o kea auwai e haku ana i kea o Apowale, - Alaila Nema 47° Nihina 60 Pautu, - a me Akau 43° Nihina me 2 kaulahao 21 Pautu, a me Akau 39°30' Nihina 179 Pautu e pili ana me kea aina o Namai a hiki i kea palena o Lolo, - alaila Nema ce kupaia i kea Lima Akau 17 Pautu me Lolo a me J. Kekaulahao a hiki i kea hoomaka ana. Eia kea Ii 702 Anana.

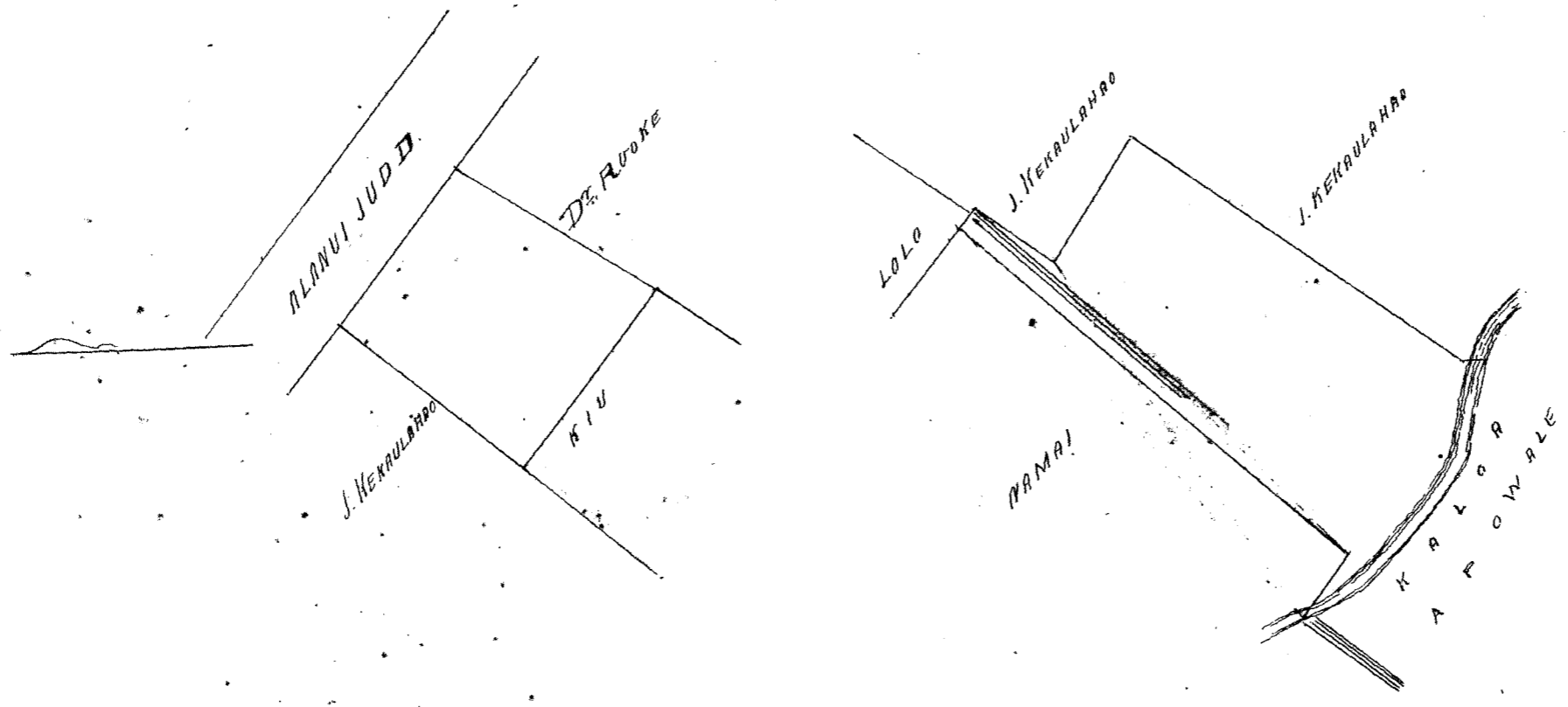

Sheet 56 FL. Lolo

Ua hoi mai oia i kona Apiana Aina ma Oloku, Honolulu aino, Hona, Oahu, e laka one ma Hanawai o ka Mo. A. 1851 ma wa Aina Tapu, ma ka one; ua hoi ia ia keia Apiana aino ma Puhana mai i ka wa e ola ana o Kiana, a ma naha keia ole ia a hiki i keia awamau.

Oia ka makou e hoohe oia ma Lolo ke kuleana hoi kama maabala iho o ke am Oloku. Ima naha mai oia i ka ke Nupuni kiapaha, alaila kupaia ia ia ka palapala Lila Kii Oloku.

Pini ma ia ia ke naha mai ma ka hooheole a ma ka hooheole ana i ka olelo Pini.

- W. L. Lee
- G. M. Robertson
- J. H. Smith
- J. Hekualahao

- No ka naha a one ke hoi aino i ka olelo ma ka Nupuni.
- No ka kope ana i wa olelo kama
- No ka palapala kii
- No ka hana ana i ka wa 10, o Mawahi 1852.
- No ka kope ana i wa olelo kii
- No ka ana ana i ka wa 4, o Augate 1852 Ua hoi \$4.00
- No ka kope ana.
- No ka hooheole ana i ka olelo i ka wa 1, o Augate 1853

\$ 3.00
Pas 24 Sep 1853

Pini ma palena.
Maia e S. P. Kalama.

I Lolo. E hoomaka ma ke kii Hikiina o keia aino, ke kii Aka o keia aino o J. Hekualahao ma kahi e kahi ai iwahe hoi wa i ka Lolo o Kii, a e ana aku i ka Aka 64° Kom: 122 Pautu ma Kii a ma Kama, a ma Aka 56° 30' Kom: 155 Pautu ma Kama, alaila Hema 39° 30' Kom: 122 Pautu ma Nupuni, alaila Hema 54° Hikiina 281 Pautu, ma Kama a ma Kama, alaila Aka 38° Hikiina 136 Pautu ma J. Hekualahao a hiki i ka hoomaka ana.
Oia ka Kii 126 Awa.

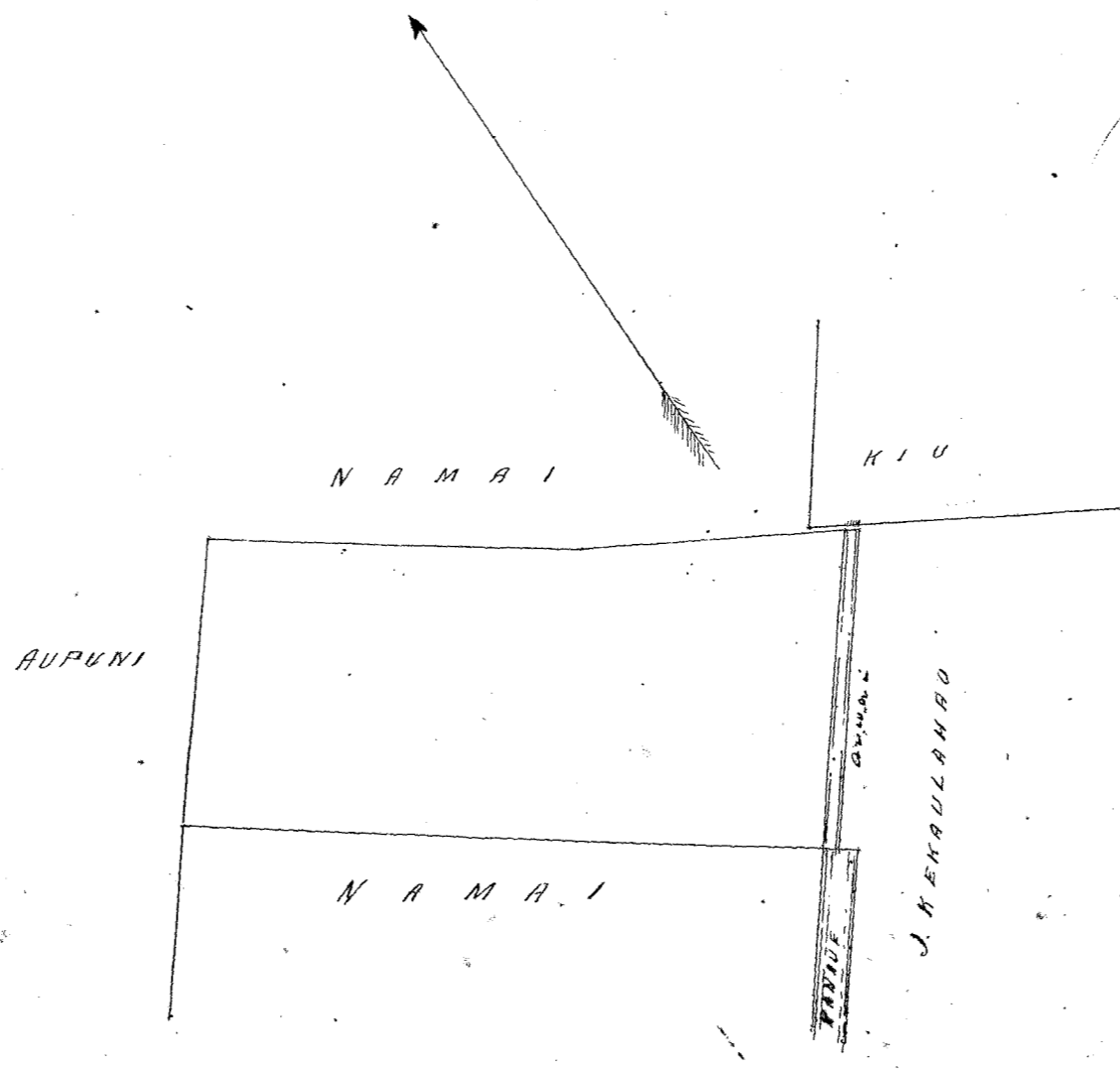

1/2 INCH IN PAPER SCALE

Hele 60 FL. Kama.

Ua koi mai via i kona Apuana aina ma Keuwa, Honolulu aina, Kona, Oahu, e like me ma Hamanai i ka Makakiki 1851, me ma Aina Pahu, me ka mea, ua hana ia keia wahi me Lolo mai i ka M. H. 1852, i ka wa o No. Kekaulaohi e mahe Kihina ana, a ua noho keakea o ia a hiki i keia manawa.

Oia ka makou e hooke nei me Kama ke kuleana hoi kona malalo iho o ke ano Alodio, Ina ukou mai via i ke ke Anupuni hapaha, alaila kupono ia ia ka Palapala Sila Nui Alodio.

Pono mai ia ia ke ukou mai me ka hoohelekele a me ka hoohele ana i ke olelo, Penei;

- W. L. Lee
- G. M. Robertson
- J. H. Smith
- J. Kekaulaha

- No ka umu a me ke pua ana i ke olelo ma ka Nupupu.
- No ke kope ana i ma olelo koina.
- No ka palapala kei.
- No ka hana ana i ke ka 22, o Maraki 1852.
- No ke kope ana i ma olelo hoi ke Pava.
- No ke ana ana i ke ka 6, o Novemaba 1852. Ua hana \$6.00
- No ke kope ana.
- No ke hoohele ana i ke olelo i ke ka 1, o Augata 1853.

Poni ma palena

Anaia e S. P. Kama.

\$ 3.00

Mookalo a me kula o ka hahale.

E hoomaka ma ke kiki Kihina, - A i ana aku i kea Nawa 44 45' Horn: 165 Paku e pili ana me Hamanai, - Alaila Kawa 35 30' Horn: 328 Paku, - a me Kawa 28° Horn: 171 Paku, - a me Kawa 55° Horn: 103 Paku ma ka palena kula a me ka palena kula o Kapali a hiki i kea papohaku, - Alaila Kawa 35° Kihina 89 Paku ma ka papohaku me Kapali a hiki i kea kiki ma ka o ke Alanui Judd, - Alaila hui-pulani ma ka kiki ma ka o Alanui e mahe ana ke kiki ma ka o keia aina a hiki i kea hoomaka ana.

Eia ka Ki 3/100 Eka

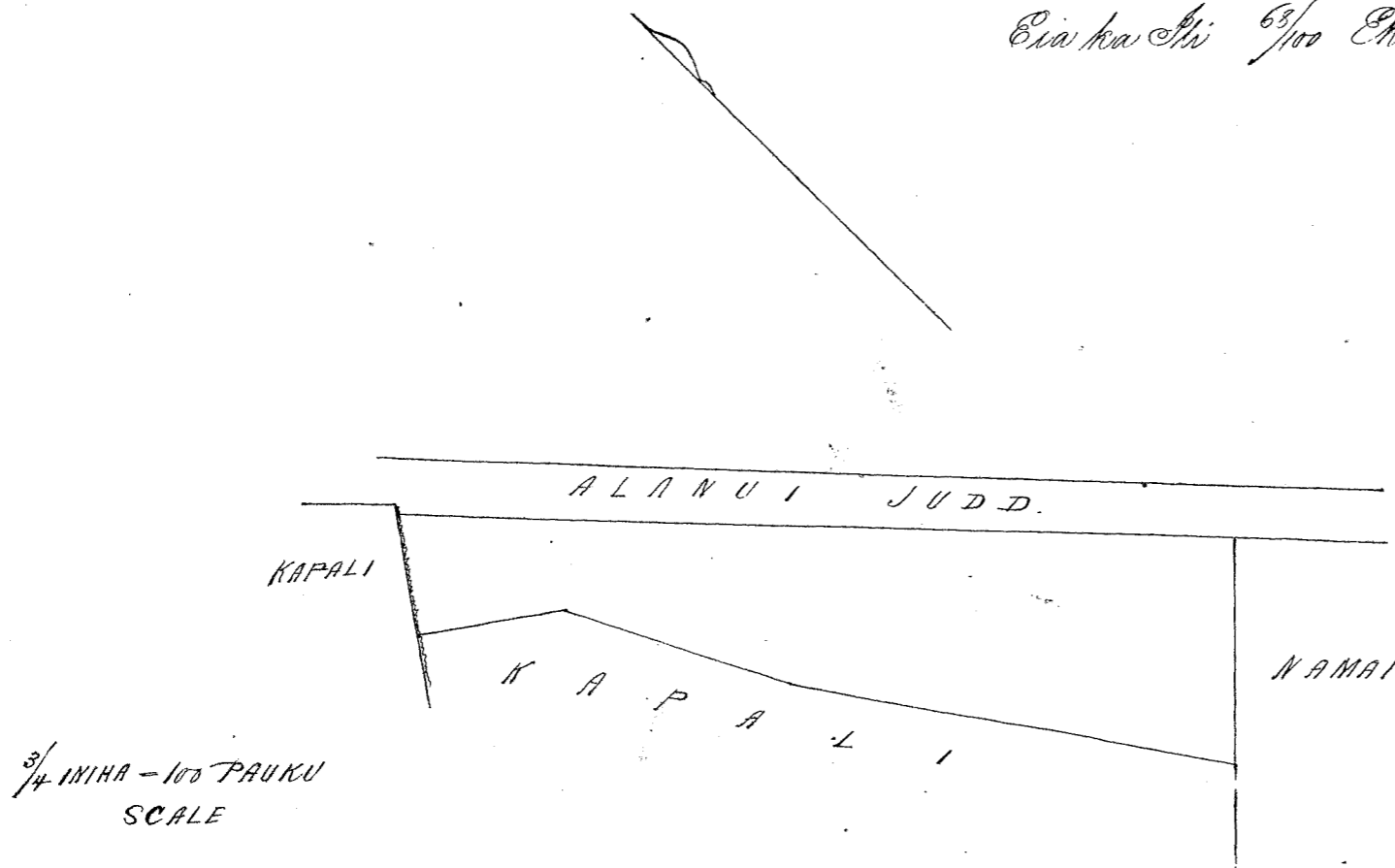

Hele 10802 Paukunui.

Ua koi mai via i kona Apuana aina ma Palikua, Honolulu aina, Kona, Oahu, me ka mea, ua hana ia ia keia aina me Kihina mai i kea wa e ole ana o Kalaimoku manawa ka aku o ka M. H. 1829, a ua noho oluwelu a hiki i keia manawa, aole keakea.

Oia ka makou e hooke nei me Paukunui, ke kuleana hoi kona malalo iho o ke ano Alodio. Ina ukou mai via i ke ke Anupuni hapaha, alaila kupono ia ia ka Palapala Sila Nui Alodio.

Pono mai ia ia ke ukou mai me ka hoohelekele a me ka hoohele ana i ke olelo, Penei;

- W. L. Lee
- G. M. Robertson
- J. H. Smith
- J. Kekaulaha

- No ka umu a me ke pua ana i ke olelo ma ka Nupupu.
- No ke kope ana i ma olelo koina.
- No ka palapala kei.
- No ka hana ana i ke ka 13, o Mei 1851.
- No ke kope ana i ma olelo hoi ke Pava.
- No ke ana ana i ke ka 16, o Maraki 1853. Ua hana \$6.00
- No ke kope ana.
- No ke hoohele ana i ke olelo i ke ka 1, o Aug. 1853

\$ 4.00

Pini ma palena. Anava v S.P. Kalamā.

L. L. me Kuba. E hoomaka ma ke kiki Nema; A. e holo Akau 40° Hikitina 194 Pautu me ke papohaku o Anaru, alaila Akau 33° Kom: 121 Pautu me ke aina o Paaha, alaila Akau 47° Kom: 247 Pautu, a me Akau 45° Hikitina 72 Pautu, a me Akau 44° Kom: 150 Pautu e pili ana me Paakahi a me Kaunihau, alaila Nema 37° Kom: 296 Pautu me ke kiki Alamui i manaoia, alaila Nema 28° Hikitina 211 Pautu me Waiaha, alaila Nema 52° 45' Hikitina 280 Pautu e pili ana me R. C. Janion a kiki i ke hoomaka ana. Eia keu Ii 1 1/4 Eka.

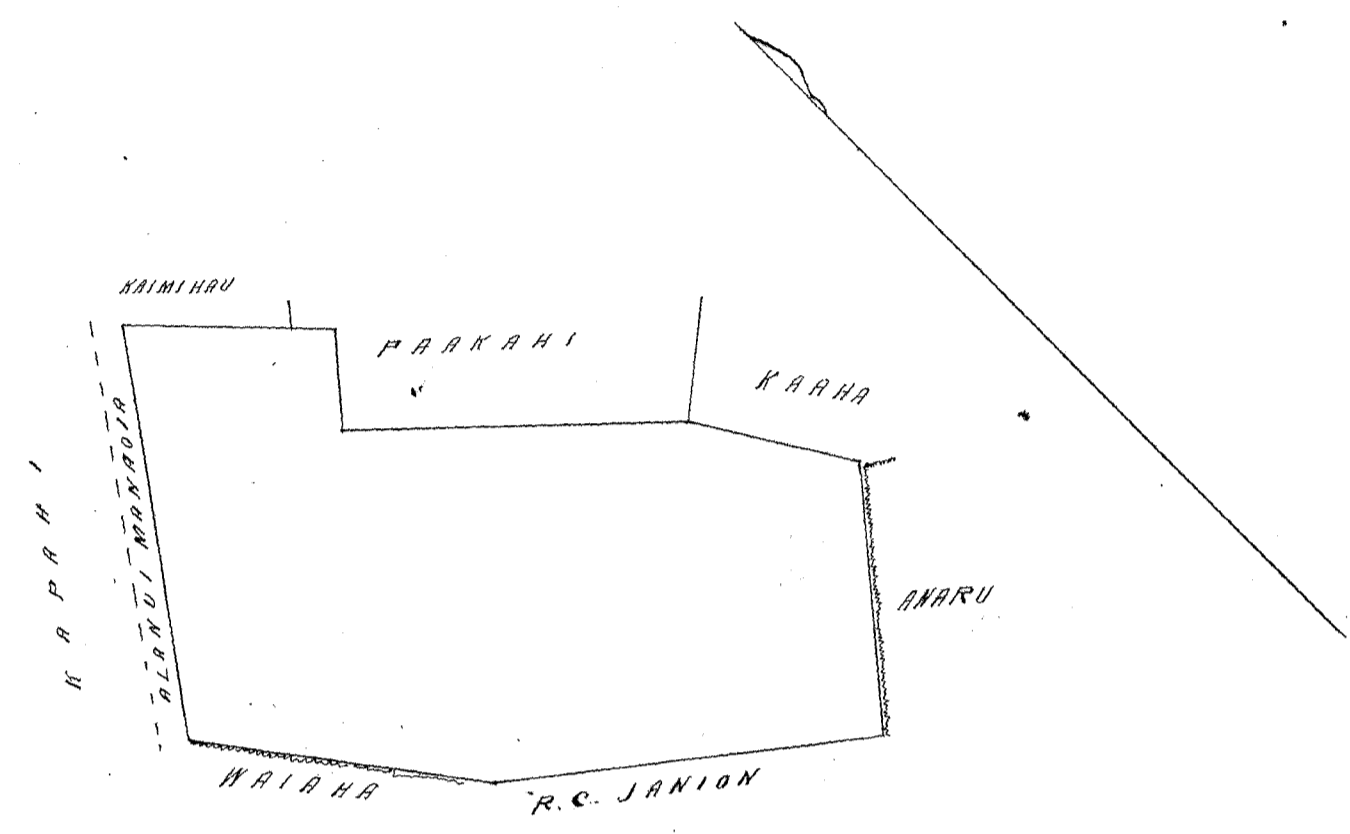

3/4 INIHA = 100 PAUKU SCALE

Hulu 2154 (Kahue mo Poupou)

Ua kei mai oia me ke ma mau Apama aina ma Apowale. Kōwhiri aina, Kōwa, Oahu, me ke ma, ua loa ia ia keia aina me Hamamurui mai i ke ma o Lord George Paulet i kei Mo. H. 1843, a ua mohe keia. He ia a kiki i keia manawa.

Oia kei makou e hoko nei in Kahue o ia Poupou keia wahi, ke hooloia kei keia matato iho o ke Auw Alodia. Ina ikeu mai ia i ke kei Oupuni keia, alaila kōpuna ia ia keia Palapala Sila Ii Alodia. Pini ma ia ia ke kei mai me ke kei hoolohole a me ke kei hoolohole ana i keia olelo, Pini;

- Mr. L. Lee
- G. W. Robertson
- J. H. Smith
- J. M. Kaula

Ke kei nui a me ke kei paia ana i keia olelo ma keia Nupupu.
 Ke kei kōpuna ana i keia olelo keia.
 Ke keia palapala keia
 Ke keia keia ana i keia la 23, o Augate 1850
 Ke keia ana ana i keia la 7, o Novemaba 1851, Ua keia \$5.00
 Ke kei kōpuna ana
 Ke keia hoolohole ana i keia olelo i keia la 1, o Augate 1853.

Pini ma palena. Anava v S.P. Kalamā.

\$ 5.00

Apana 1. L. L. me Kahuahale. E hoomaka ma ke kiki Akau o keia Apana aina, e pili ana me ke kiki Kōwhiri ma keia o keia aina o ke Nupuni. A. e holo Kōwa 55° 30' Hikitina 151 Pautu, a me Nema 68° 30' Hiki: 59 Pautu e pili ana me ke aina o ke Nupuni a kiki i Kauluwela. Alaila Nema 7° Hiki: 27 Pautu, a me Nema 33 Kom: 194 Pautu, a me Kōwa 45° Kom: 94 Pautu e pili ana me Kauluwela a kiki i keia aina o Kōwa me Kahuahale, alaila Akau 43° 30' Kom: 213 Pautu e pili ana me ke aina o Kōwa a kiki i keia aina o Kōwa me Kōwa, alaila Akau 26° Hikitina 142 Pautu e pili ana me ke Kōwa, - (alaila keia ma keia lina Nema o keia aina, ma keia aina o keia L. L. o keia e pili ana me keia Apana aina i keia aina i S. P. Kalamā a kiki i keia hoomaka ana. Eia keu Ii 5/8 Eka.

Apana 2. L. L. me Auwai ma Apowale Ii me Kōwhiri Oahu. E hoomaka ma ke kiki Akau o keia Apana aina i keia Poupou e pili ana me ke kiki Kōwhiri ma keia o keia aina o ke Oupuni; A. e holo Akau 23° Hikitina 81 Pautu, kiki, a me Akau 56° 30' Kom: 123 Pautu

e pili ana, mihi aino o ke Aupuni a me ka aino i koina e Kawepuana a hiki i ka auwai e pili ana me "Apaako," Alaila Kema 32' Kom. 108 Pautu, a me Kema 28' Kom. 67 Pautu ma ka auwai me "Apaako" a hiki i ke kahi Maui o ke Kuleana o Nalaunui no Maawe i ka Matachaaakoa, Alaila Kema 46' 1/2' Hikiina 113 Pautu me Matachaaakoa a hiki i ka auwai kahi Kema me Poupou, Matala aku i ka ma ka kahi kema o ka auwai ma kuauna o Poupou a hiki i ka hoomaka ana, Eia ka Ii 2/100 Eka.

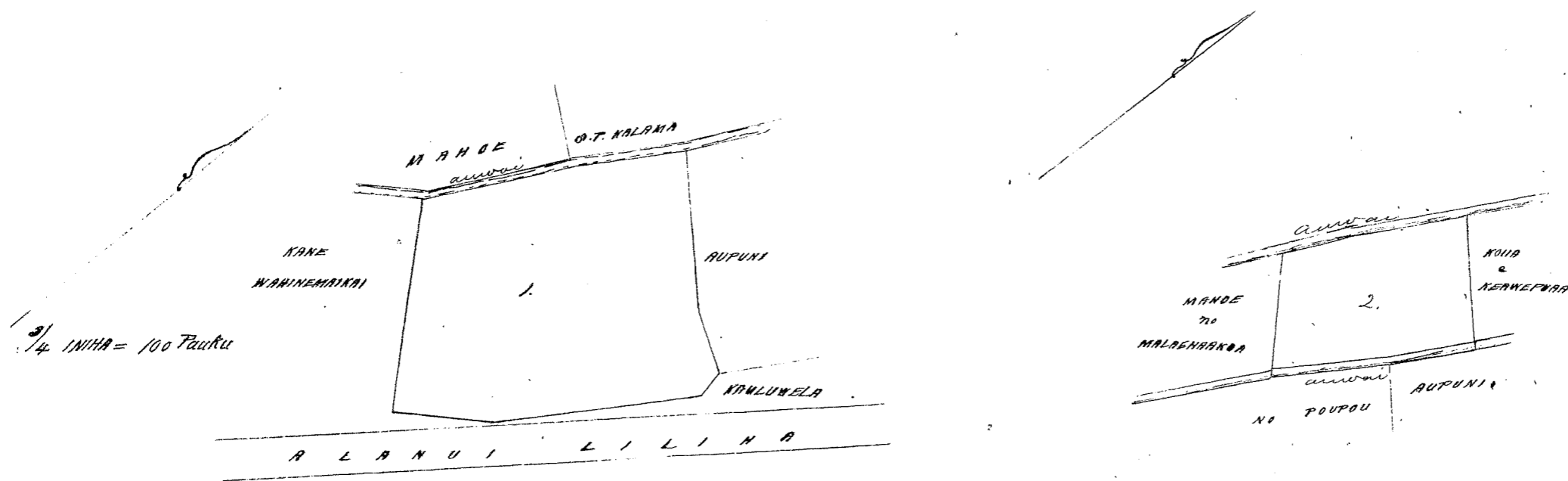

- Helu 1131 Piliani

Ua hoi mai oia no kona mau Apama aino ma Kawananakoa Nuuanu i Honolulu ma Koma ma ka Mookupuni o Oahu; no ka mea, ua loaia iaia keia mau wahi no Kaaha mai i ka Makahiki 1844, a ua noho keakea oleia a hiki i keia manawa.

Oia ka makou e hooke nei no Piliani; he kuleana hoi kama inatalo iho o ke Ano Alodio. Ina e ukou mai oia i ke ke Aupuni hapuaha; alaila, ua kumpo iaia ka Palapala Sika Alodio.

Pono nua iaia ke ukou no ka hooholoholo a me ka hooholo ana i ka olelo. Penei

- | | |
|-----------------|--|
| W. L. Lee | No ka kumi a me ke pai ana i ka olelo ma ka Muepepa |
| G. M. Robertson | No ke kope ana i ka olelo koina |
| C. H. Smith | No ka palapala kii |
| J. Kekantaha | No ka kama ana i ka la 30 o June 1848. |
| | No ke kope ana i ka olelo a ma hoi ke 1 Awaa |
| | No ke ana ana i ka la 16, o Maraki 1853. Kua ke ana \$5.00 |
| | No ke kope ana |
| | No ka hooholo ana i ka olelo i ka la 11 o Awgate 1853. |

\$ 5 00

Eia nu palena. Anuia e S. P. Kalama.

Apama 1. 3 Loi me Kula o Kahuahala ma Kawananakoa, Nuuanu Ii Honolulu, Oahu. E hoomaka ma ke kahi Hikiina, - a e holo Kema 49' 30' Kom. 53 Pautu, a me Maui 49' Kom. 70 Pautu, a me Kema 44' 30' Kom. 122 Pautu e pili ana me Kalahouka, - Alaila Maui 47' 30' Kom. 30 Pautu ma ka Konoiki a me Paakahi, - Alaila Maui 58' Hikiina 207 Pautu, - a me Maui 70' Hiki 46 Pautu, - a me Maui 56' Hikiina 85 Pautu me Kaunihau a me Konoiki, - Alaila Kema 12' 30' Hikiina 53 Pautu, a me Kema 35' Kom. 119 Pautu, a me Kema 1' Kom. 38 Pautu, - a me Kema 47' Hikiina 157 Pautu e pili ana me ka aino o Kapelaumoku no ke Konoiki i ka hoomaka ana, Eia ka Ii 6/100 Eka.

Apama 2. 2 Loi. E hoomaka ma ke kahi Hikiina, - a e holo Kema 44' Kom. 156 Pautu a me Maui 53' Kom. 154 Pautu e pili ana me ka pa o Anau, - Alaila Maui 31' 15' Hikiina 165 Pautu me Konoiki a me Kalahouka, - Alaila Kema 48' Hikiina 193 Pautu me Kalahouka a hiki i ka hoomaka ana, Eia ka Ii 28/100 Eka
Pau loa 95/100 Eka

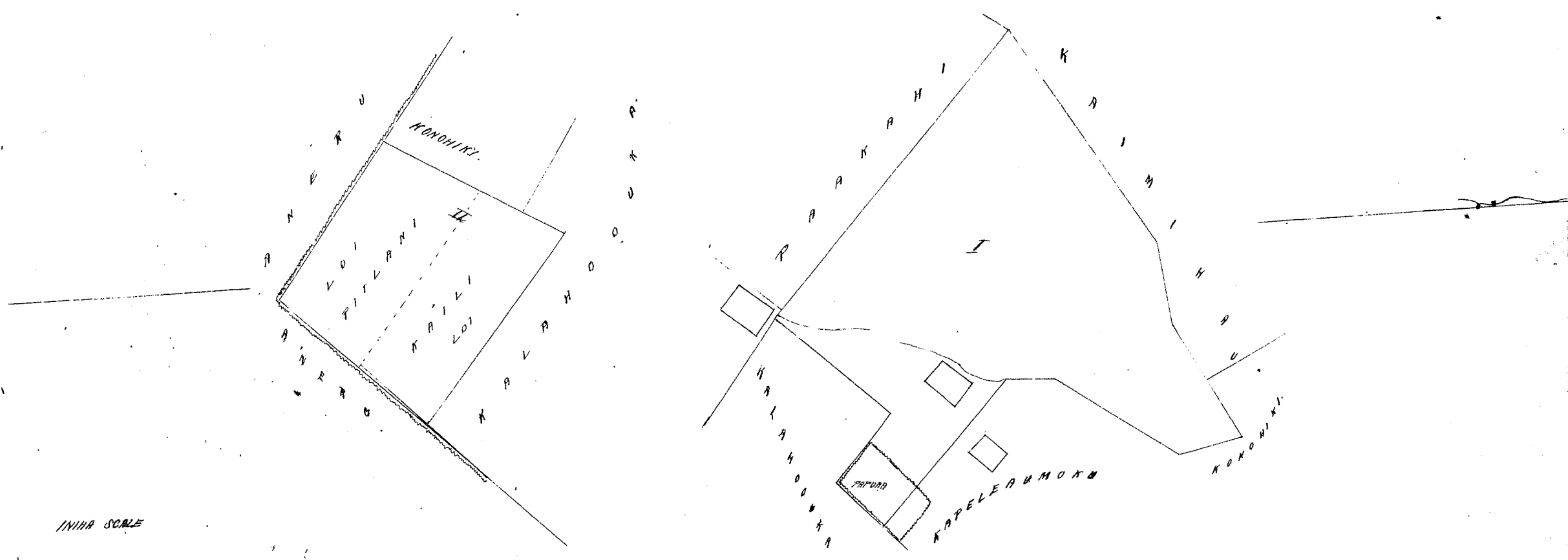

1/4 INCH SCALE

Kelu 5049 B (Keoki no Kealule)

Ua hoi mai oia no kona Apona aino ma ka Ili o Olomana i Honolulu ma kona ma ka Moku o Oahu; no ka mea, ua hooia ia ia keia wahi no Hamakahiki ma i ka wa e ole ana o Hinawa mamua aku o ka M. K. 1839, a ua noho oia malaila ahiki i ka makahiki 1853, hooilo aku oia i keia wahi ia Kealule, a ke noho mai no Kealule malaila ahiki i keia manawa.

Oia ka makou e hooilo mai no Keoki a ia Kealule, ke hulema hoi kona malalo iho o ke Aho Alodia. Ina e uku mai oia i ke Aupuni hoapaha, alaila, ua kupaia ia ia ka Palapala Sila Alodia.

- W. L. Lee
- G. M. Robertson
- C. H. Smith
- E. Kekaulaao

- No ka nuniia, me ke pua unai ka olelo ma ka Mapepa.
- No ke kope ana i ka olelo koina
- No ka palapala kii
- No ka hana ana i ka la 8 o Feberuari 1853.
- No ke kope ana i ma olelo a ma hoike 1/2 Awa
- No ke ana ana i ka la 22 o Iulii 1853.
- No ke kope ana
- No ka hooilo unai ka olelo i ka la 11 o Auguta 1853.

Eia ma palena.

Anaia e S. J. Kalama

6.00

Ma Olomana Ili no Honolulu, kona, Oahu.

4 Loi. O hooimaka ma ke kahi Akau o keia aino, a e ana aku (Kona 33° Hikiina 206 Panku me Kahalo Kona 49° Kona 198 Panku me Aupuni; Akau 29° Kona 277 Panku me Aupuni no ke kula; Akau 35 1/2° Hikiina 31 Panku me Kahalo; Akau 61° Hikiina 66 Panku me Kahalo; Kona 59° Hikiina 45 Panku me Kahalo; Akau 70° Hikiina 64 Panku me Kahalo a hiki i ka hooimaka ana.

Eia ka Ili 47/100 Eka.

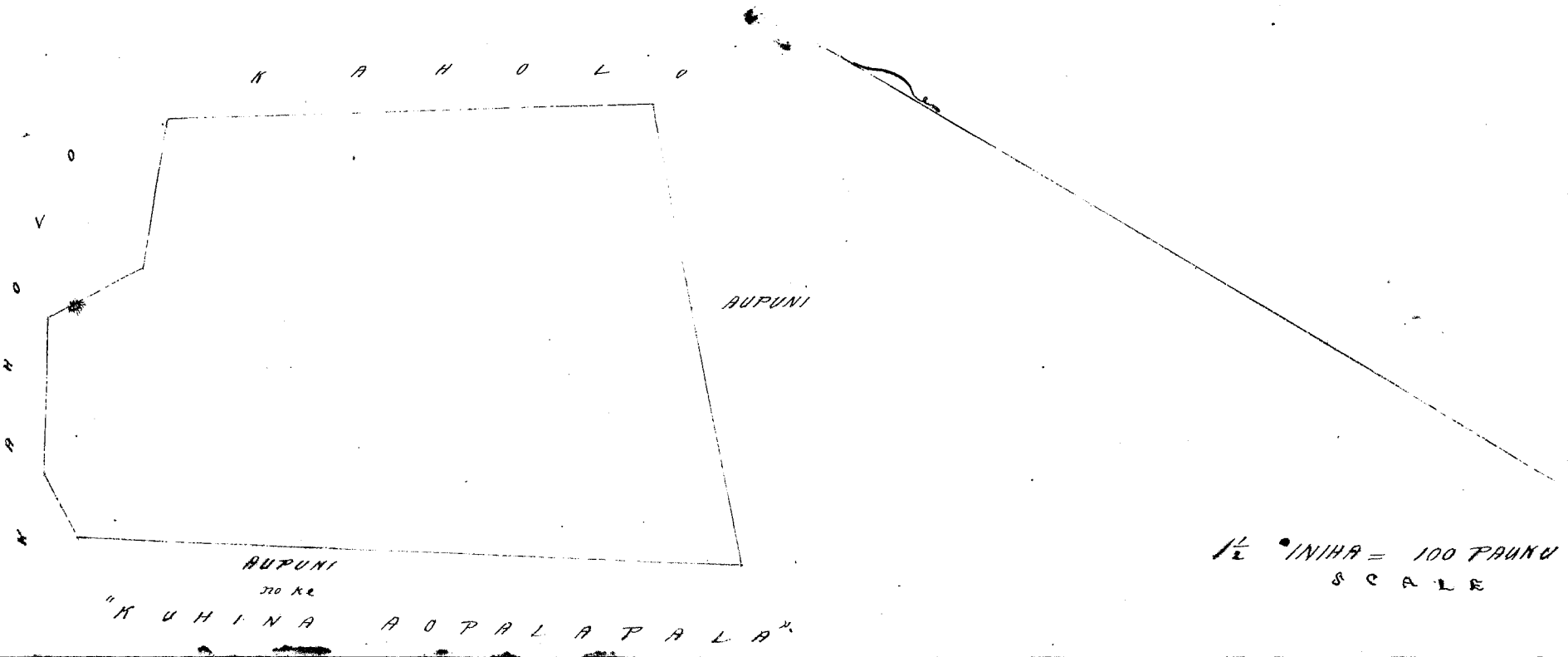

1/2 INCH = 100 PANKU SCALE

Kelu 3453 Kalina

Ua hoi mai oia me kona Apiana aima ma ka Iki o Kaolu i Nuuanu Honolulu me kona ma ka Moku o Oahu; no ka mea, ua loaia iia i keia wahi no Paahahi mai i ka M. A. 1845, a wa noho oia i keia i keia manawa.

Oia ka makou e hooke meino Kalina; he kuleana hoi kona malalo iho o ke Aua Alodio. Ima e uku mai oia i ke ke Aupuni hapaha; alaila, ua kupona iia i ka Palapala Ika Alodio.

Pono mai iia i ke ika no ke hooke oia a me ke hooke ana i ke olelo. Penei,

W. L. Lee
G. W. Robertson
J. H. Smith
I. Kekaulaha

No ke kope a me ke pua aima i ke olelo ma ka Moku
No ke kope ana i ke olelo: koina
No ka palapala kii
No ka hana ana i ka la 27 o Novemaba 1850
No ke kope ana i wa olelo a wa hoike 1/3 Aua
No ke ana ana i ka la 22 o Iulai 1853. Kua ke ana 1/4
No ke kope ana
No ka hooke ana i ke olelo i ka la 11 o Augata 1853.

Oia me palena. *Anaia S. P. Kalama*

4

Ma Kaolu Nuuanu Honolulu Oahu

I Loi me Kula. E hoomaka ma ke kiki Kema. Auehola Akau 44° Kom. 246 Pauh me Ala Olohi; Akau 42° Hiki. 17 Pauh me Kalahouka; Akau 36° Kom. 83 Pauh me Kalahouka; Akau 45° Kom. 274 Pauh me Kalahouka; Akau 33° Kom. 89 Pauh me Kapelaumoku; Akau 42° Hiki. 79 Pauh me Kapelaumoku; Akau 19° Hiki. 62 Pauh me Kapelaumoku; Kema 47° Hiki. 286 Pauh me Kalawatu; Kema 44 1/2° Kom. 93 Pauh me Aupuni; Kema 37° Hiki. 219 Pauh me Aupuni; Akau 50° Hiki. 109 Pauh me Aupuni; Kema 41 1/2° Hiki. 166 Pauh me Aupuni a pili ana me ke Ala Olohi ma ka Apiana aima Aupuni a hiki i ke Alanui Nuuanu; Alaila Kema 29° Kom. 179 Pauh ma ka Iki Kamahele a ke Alanui Nuuanu a hiki i ke hoomaka ana.

Oia ka Iki ⁶⁶ 100 Eka.

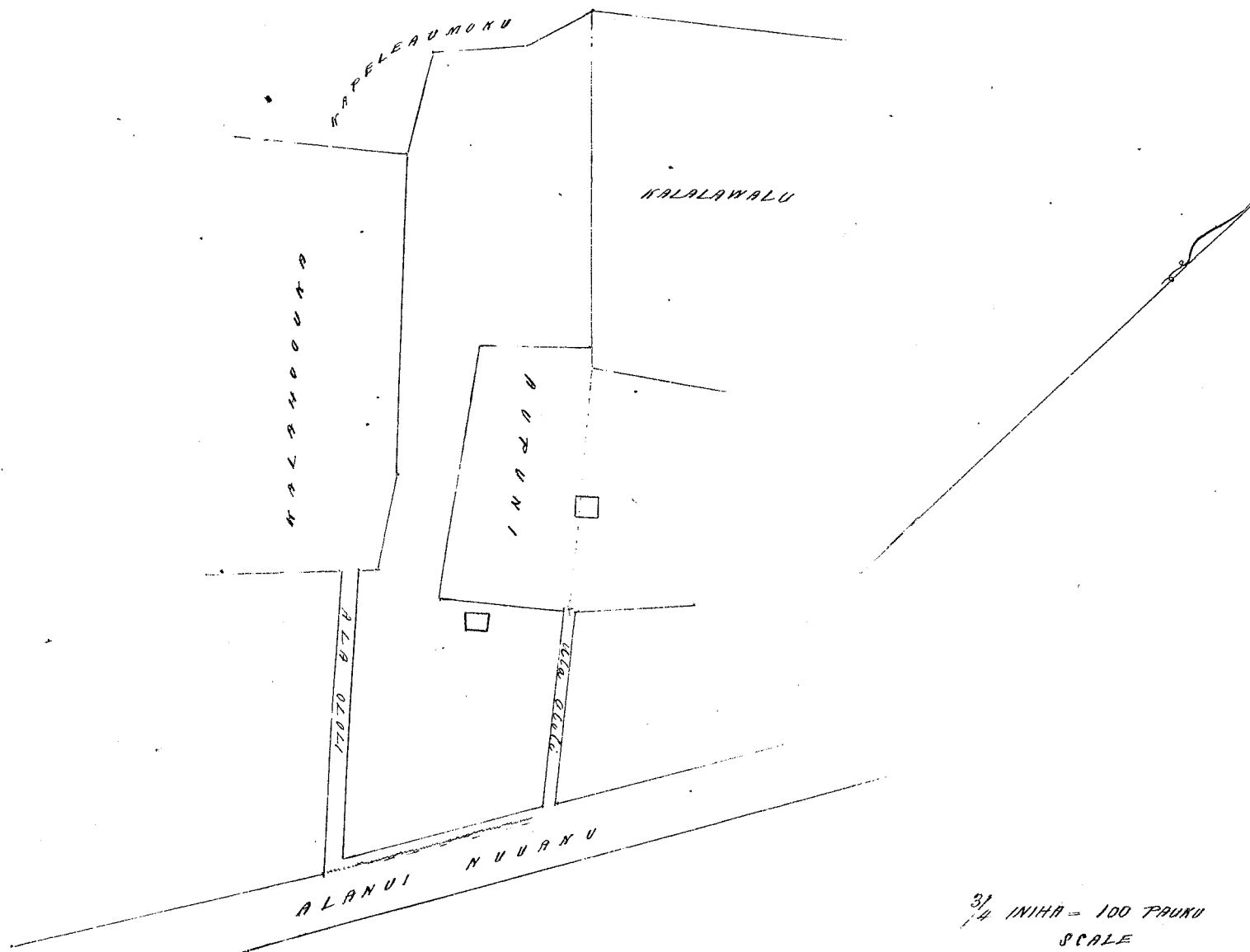

3/4 INCH = 100 PAHA SCALE

Heleu 2253 Kohopa

Ua koi mai oia no kona mau Apana aina ma ka Ili o Aiea i Honolulu ma kona mau ka Mokupuni o Oahu; no ka mea, ua loa ia ia keia mau Apana no Keheua mai i ka manawa o Pahi, a ua noho mau no oia ma lalo a hiki i keia manawa.

Oia ka makou a hoohe'oe no Kohopa; he kuleana hoi kona malalo iho o ke Ano Alodio. Ina e ukui mai oia i ke ke Aupuni hapaha; alaila, ua kuperua ia ia ka Palapala Lilo Alodio.

- Pono mai ia ia ke ukui no ka hoohe'oe a me ka hoohe'oe ana i ka olelo; Penei
- W. L. Lee No ka rumi a me ke pua ana i ka olelo ma ka Muepepa
- G. M. Robertson No ke kopu ana i ka olelo keima
- C. H. Smith No ka palapala kii
- E. Kekuulaho No ka hana ana i ka la 15 o Okatoba 1851.
- No ke kopu ana i wa olelo a wa hiki 1/2
- No ke ana ana i ka la 27 o Aperita 1853.
- No ke kopu ana
- No ka hoohe'oe ana i ka olelo i ka la 11 o Augata 1853.

Oia ma palena Aiea o S. P. Kalama

4

Mo Apana Ili Honolulu, Oahu:

Apana 1. 2 Loi. E hoomaka ma ke kahi Kahu o keia Apana aina, a e ana Kama 25^o Kom. 7 Pahu me Kamikama; Kama 58^o Hik. 21 Pahu me Koluua; Kama 34^o Kom. 81 Pahu me Koluua; Kama 62^o Hik. 129 Pahu me Luiki o Kama; Kama 19^o Hik. 81 Pahu me Luiki o Kama; Kama 59^o Kom. 129 Pahu me Kolu "Kahu" Aupuni a hiki i ka hoomaka ana.

Ka Ili 126 Apana

Apana 2. 2 Loi. E hoomaka ma ke kahi Kahu o keia Apana aina, a e ana Kama 36^o Kom. 6 Pahu me Luiki o Kamakela; Kama 19^o Kom. 52 Pahu me Luiki o Kamakela; Kama 46^o Kom. 78 Pahu me Luiki o Kamakela; Kama 41^o Hik. 72 Pahu me Kamaka; Kama 78^o Hik. 24 Pahu me Kama; Kama 39^o Hik. 81 Pahu me Kama; Kama 67^o Hik. 39 Pahu me Kama; Kama 33^o Hik. 97 Pahu me Kama; Kama 7^o Kom. 80 Pahu me Kama; Kama 55^o Kom. 22 Pahu me Kama a hiki i ka hoomaka ana.

Ka Ili 242 Apana

Apana 3. 1 Loi. E hoomaka ma ke kahi Kahu o keia Apana aina, a e ana Kama 55^o Kom. 60 Pahu lihi Kama Auwai; Kama 1^o Degere Hik. 90 Pahu lihi Kama Auwai; Kama 47^o Hik. 118 Pahu me Kamaka; Kama 47^o Hik. 92 Pahu me Moahu; Kama 36^o Kom. 176 Pahu me Luiaia a hiki i ka hoomaka ana.

Pau loa ka Ili 722 Apana

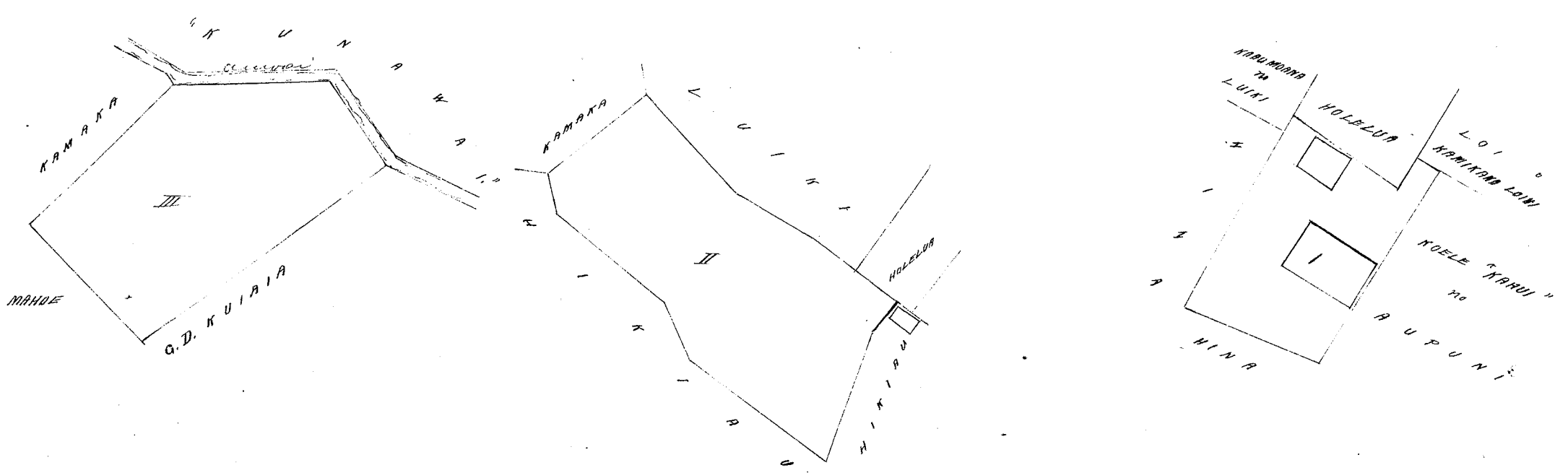

1/4 INCH = 100 PAHU SCALE

Hele 6 FL Waa

Waa

Ua koi mai oia no kowa wahi Apamu aina ma ka Ili o Kaole i Waikiki ma Kona, ma ka Mokuapuni o Oahu, e like me na Kanawai o ka Makahiki 1851, no na Aina Pahu; no ka mea, ua loa ia ia keia wahi no Kaluakimani mai i ka wahi o na Kanawai o Waikiki ma Oahu i ka M. A. 1831, a ua moko keakea oleia a hiki i keia manawa.

Oia ka mahua e hooke me no Waa; he kuleana hoi koma ma ka Aho Alodio. Aia e uka mai oia i ka Aho Alodio, alaila, ua hupono ia ia ka palapala sila Alodio.

Pono nae ia ia ke uka no ka hoocholo a me ka hoocholo ana i ka olelo, Puni.
No ka runi a me ke pui ana i ka olelo ma ka Muepapa
No ka kope ana i ka olelo hoina
No ka palapala hui
No ka hana ana i ka la 16 o Detemaba 1851.
No ke kope ana i ka olelo a ma hoi ke 1/3 Awa
No ke ana ana i ka la 12 o Febuari 1853. Kaa ke ana \$2.
No ke kope ana
No ka hoocholo ana i ka olelo i ka la 11 o Augate 1853.

W. L. Lee
G. M. Robertson
J. H. Smith
J. Kekaulahao

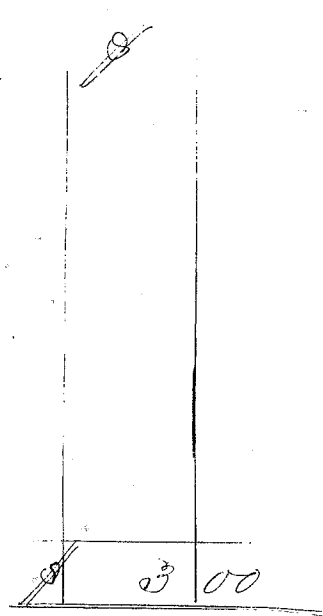

Eia na palena. Aia i S. P. Kalamu

1 Poi ma Kahe Ili no Waikiki, Oahu.

E hoomaka mau ke kiki Kaa o keia aina, - Ue holo Kona 26' Kona 148 Pahu e pili ana me ka uina o Kalalawalu; Alaila Kona 62' Kikina 178 Pahu e pili ana me Kanaiwahia; - Alaila Kaa 23' Kikina 156 Pahu e pili ana me ka uina o ke Aupuni; - Alaila Kaa 65' Kona 161 Pahu e pili ana me Kanaiwahia a hiki i ka hoomaka ana.

Eia ka Ili 25/100 Oka

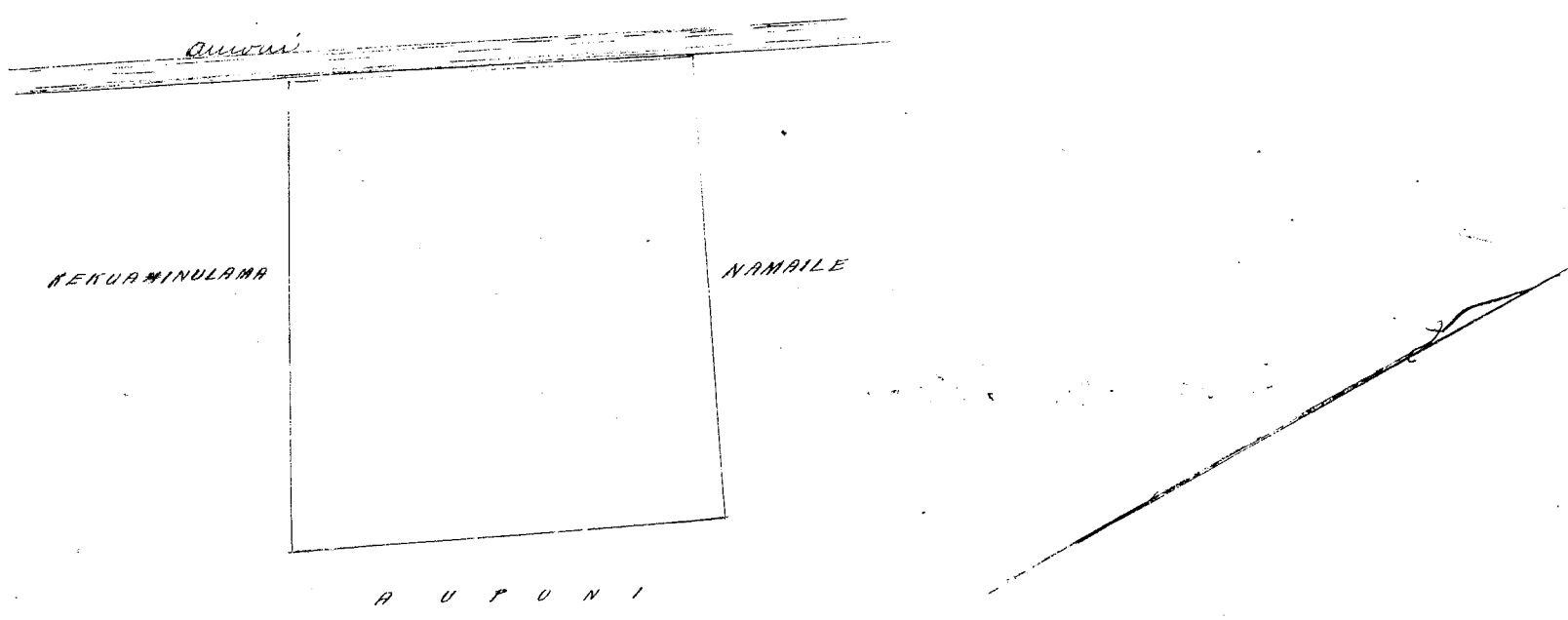

SCALE 1/2 INCH = 100 PAHU

Hele 7 FL Namaile

Namaile

Ua koi mai oia no kowa Apamu aina ma ka Ili o Kaole i Waikiki, ma Kona, ma ka Mokuapuni o Oahu, e like me na Kanawai o ka Makahiki 1851, no na Aina Pahu; no ka mea, ua loa ia ia keia wahi no Kona, mai i ka wahi o ka Aina o Kanaiwahia ma ka M. A. 1839, a ua moko keakea oleia a hiki i keia manawa.

Oia ka mahua e hooke me no Namaile; he kuleana hoi koma ma ka Aho Alodio.
Pono nae ia ia ke uka me ka hoocholo a me ka hoocholo ana i ka olelo. Puni,

No ka runi a me ke pui ana i ka olelo ma ka Muepapa
No ke kope ana i ka olelo hoina
No ka palapala hui
No ka hana ana i ka la 16 o Detemaba 1851.
No ke kope ana i ka olelo a ma hoi ke 1/3 Awa
No ke ana ana i ka la 12 o Febuari 1853.
No ke kope ana
No ka hoocholo ana i ka olelo i ka la 11 o Augate 1853.

W. L. Lee
G. M. Robertson
J. H. Smith
J. Kekaulahao

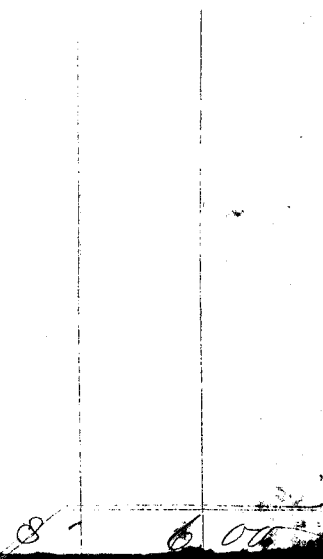

Amawa i S.P. Kalama.

2 Loi ma Waialeale, Niihau, Oahu.

E hoomaka ma ke kahi Akau, a e ana aku i kai Kona 23° 30' Norn. 4 Kaulaheo 37 Panku e pili ana ma ka lani Kona, a e ana aku i kai Kona 23° 30' Norn. 4 Kaulaheo 37 Panku e pili ana ma ka lani Kona, a e ana aku i kai Kona 23° 30' Norn. 4 Kaulaheo 37 Panku e pili ana ma ka lani Kona...

Eia ka Iki 99/100 Eka.

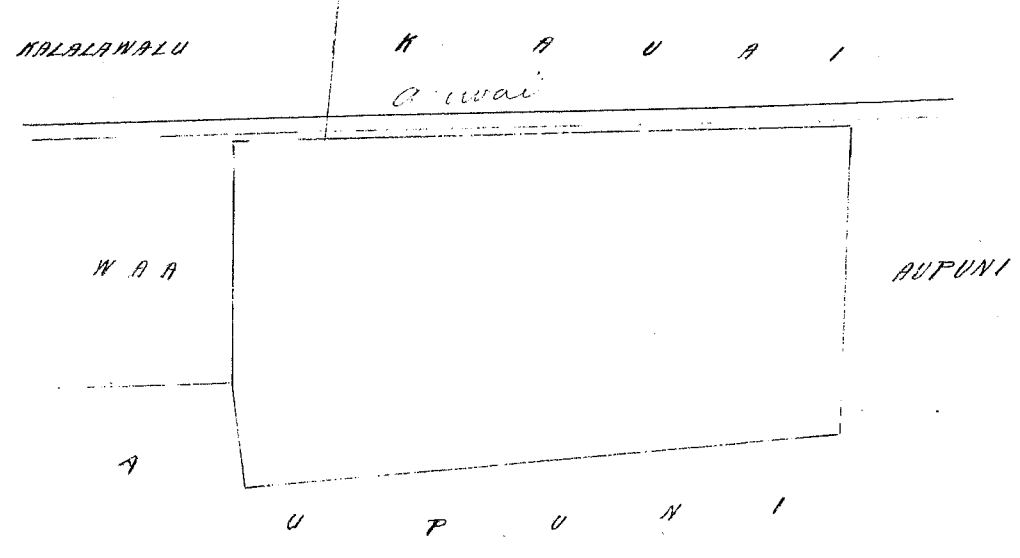

SCALE 3/4 INCH = 100 PANKU

Helu 100 FL Kekauba

Ua hoi mai oia i ka mea Ahewa aia ma ka Iki, Kalua i Niihau, ma Kona, ma ka Wokupuni, Oahu, e like me oia i ka mea Ahewa aia ma ka Iki, Kalua i Niihau, ma Kona, ma ka Wokupuni, Oahu, e like me oia i ka mea Ahewa aia ma ka Iki, Kalua i Niihau, ma Kona, ma ka Wokupuni, Oahu...

- W. L. Lee
- G. M. Robertson
- J. H. Smith
- J. Kekaulaha
- No ka kumu a me ke pahi ana i ka olelo ma ka Nupupu
- No ke kope ana i ka olelo koina
- No ka palapala kii
- No ka hana ana i ka la 25 o Iulai 1853.
- No ke kope ana i na olelo ma hoike 14 aia
- No ke hana ana i ka la 20 o Iulai 1853.
- No ka kope ana
- No ka hoholo ana i ka olelo i ka la 11 o Augata 1853.

\$ 12 00

Eia ma palawa Amawa i S.P. Kalama

Aina ma Kalua, Niihau, Oahu.

1 Loi, 2 Loko, a me 5 Kiohwa, 5 Kula. E hoomaka ma ke kahi Kona o keia aina e pili ana ma ka lani Kona, a e ana aku i kai Kona 23° 30' Norn. 4 Kaulaheo 37 Panku e pili ana ma ka lani Kona, a e ana aku i kai Kona 23° 30' Norn. 4 Kaulaheo 37 Panku e pili ana ma ka lani Kona...

Eia ka Iki 8 1/2 Eka.

Kuleana o Okaula
Olele 100 IL

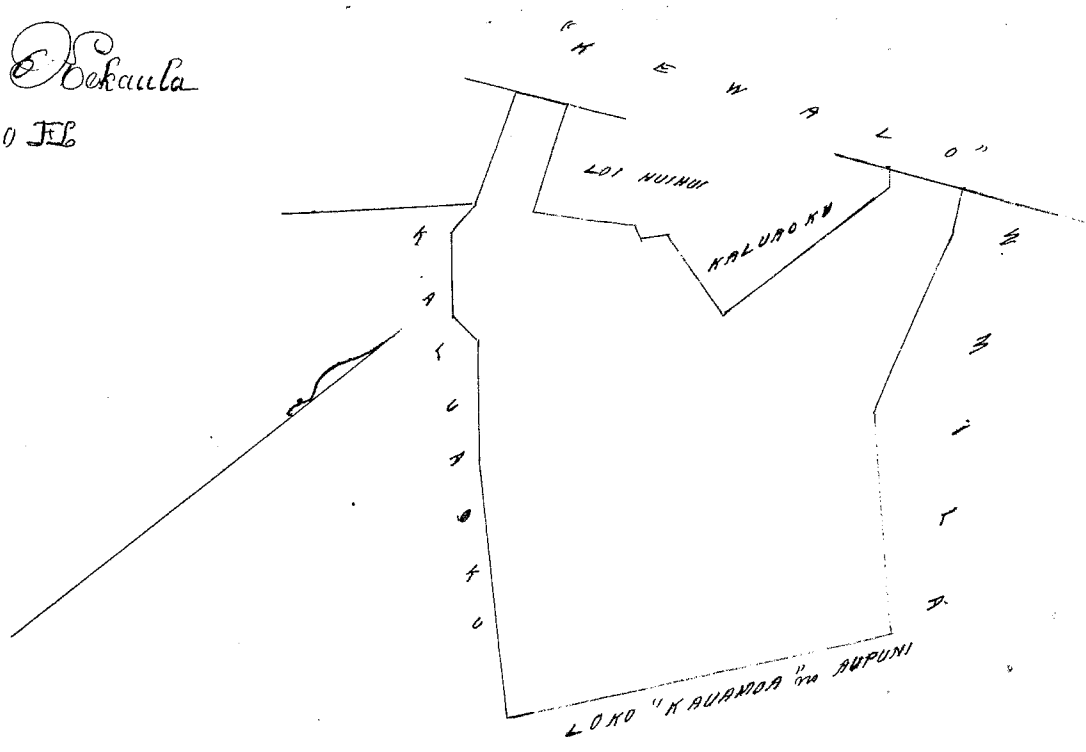

SCALE 400 PAUKU = INIHA

Helu 63 Namau (Kuleana)

Ua hoi mai oia mo kona Pahale ma Honolulu, ma Kona, ma ka Mokupuni o Oahu; ma ka mea, ua hooia iia iia keia wahie no Kaupeua mai kona kaikunahine i ka wa o ka holo ana o Peki ma i Tahiti, a ua noho keakea oia a hiki i keia manawa.

Oia ka makou e hooke me i N. Namau; he kuleana hoi kona ma alalo iho o ke Aua Alo-dio. Ima e ukou mai oia i ke ke Aupeua hapaha; alaila, ua kaupeua ia ia ka Palapala Sila Alo-dio.

Pono mai ia ia ke ukou mo ka hooholokolo a me ka hooholo ana i ka olelo Puni.

- W. L. Lee
- G. M. Robertson
- J. H. Smith
- J. Kekaulaha

- No ka kumu a me ke pua ana i ka olelo ma ka Muepea
- No ke kope ana i ka olelo koina
- No ka palapala hii
- No ka hana ana i ka hua 3 o Iulai 1848.
- No ke kope ana i ka olelo ma hooke 1 1/2 Aua
- No ke ana ana i ka hua 3 o Feberuari 1853.
- No ke kope ana
- No ka hooholo ana i ka olelo i ka hua 11 o Augato 1853.

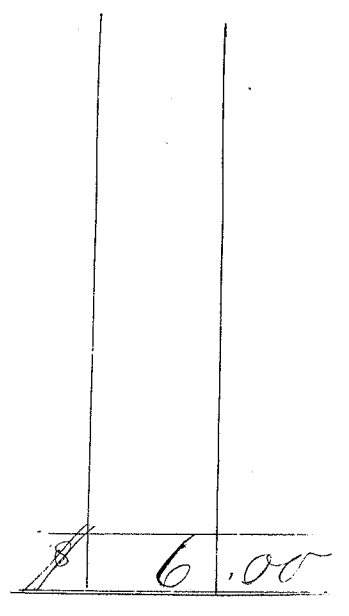

Oia ma palena Anaia e S. P. Kalama

Pahale ma Honolulu, Oahu.

E hooi ma ka mea ke hiki ika ma ka kua Pahale; ma ka hiki makai o ke Alanui Alii Mahine, a e holo Kona 57 Kom. 198 Pauku, - ame ika 40 Kom. 68 Pauku pili me ka pua o M. Kekuanawa; - Alaila Kona 54 30 Kom. 189 Pauku e pili ana me ka pua o Ioane Si; - Alaila Kona 44 Hikiina 88 Pauku, - a me Kona 60 Kom. 205 Pauku e pili ana me ka pua o M. Kekuanawa a hiki i ka hua kua; - Alaila Kona 4 Kom. 49 Pauku ma ka hua kua; - Alaila Kona 57 Hikiina 237 Pauku, - a me Kona 50 Hikiina 113 Pauku e pili ana me ka pua o Paewahine; - Alaila Kona 47 30 Hikiina 155 Pauku, - a me Kona 35 30 Hikiina 12 Pauku e pili ana me ka pua o Namama; Alaila Kona 44 Hikiina 67 Pauku me A. Peki ame Manuiki; - Alaila Kona 30 Kom. 75 Pauku, - ame Kona 56 15 Hikiina 132 Pauku e pili ana me ka pua o Manuiki; - Alaila Kona 48 Kom. 67 Pauku ma ka hiki makai o ke Alanui Alii Mahine a hiki i ka hooi ma ka mea. Oia ka Ali 73/100 Eka

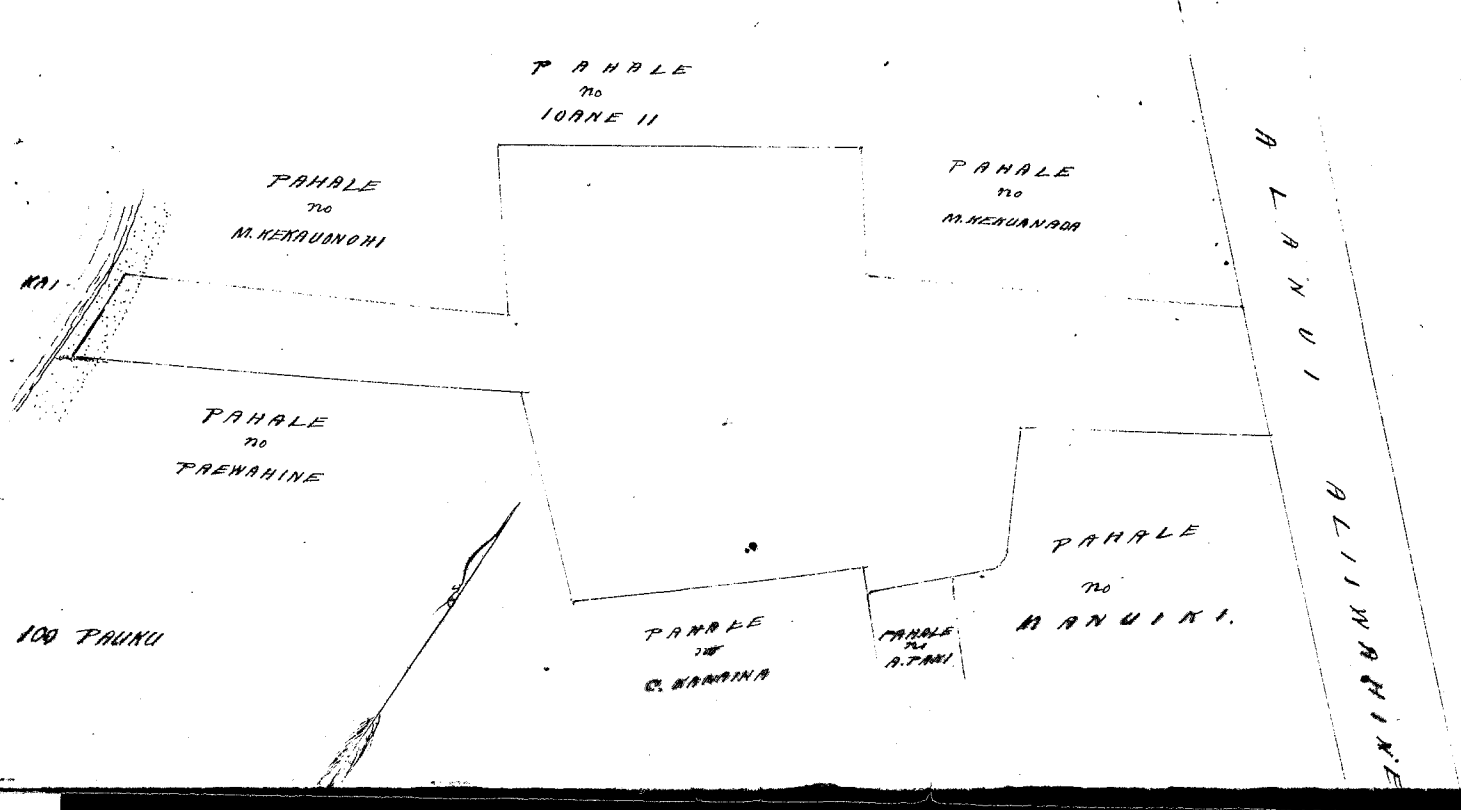

SCALE INIHA = 100 PAUKU

Helu 11033 George Shaw & Maunahina

Ua hoi mai laua no ko laua Kapuaia i loko o Kihoholea Miana ma Lahaina, ma ka Mo-
kupuni o Maui; no ka mea, ua loa ia laua keia aina no ka Mii Samohama III mai i ka Mahala aina ma
i ka Makahiki 1848, a ua noho hekeia o lona i hiki i keia manawa

Oia ka makou e hooke nei no George Shaw & Maunahina; he kuleana hoi ko laua ma lalo iho o ke
ano Alodio. Ah Ina e uku mai laua i ke ke Kupuni hapa; Ua ike, kupono ia laua ka palapa Sila Alodio. Aka,
hoe ma kuleana o ma Kanaka ma loko. Ua hooke aku makou i keia kuleana maunahi o wa olelo o ke Kanawai hoi i
hohohola ma ka la 19 o June M.H. 1852, e pili ana i wa Konoheki.

Pou ma ia laua ke uku no ka hohohola a me ka hohohola ma i ka olelo, Penei

- W. L. Lee No ka irumi a me ke piai ana i ka olelo ma ka Kupepa
- No ke hope ana i ka olelo keina
- G. M. Robertson No ka palapala keia
- J. H. Smith No ka hana ana i ka la
- A. M. Kaula No ke hope ana i wa olelo a ma hoike
- No ke ana ana i ka la 5 o October 1852.
- No ke hope ana
- No ka hohohola ma i ka olelo i ka la 27 o Augate 1853.

Oia ma palena. Ania e A. F. Sumner

1/2 Kihoholea Miana, Lahaina, Maui.

E hoonahea ana ma ke kiki Kema, a e holo ana

Mk. 48	No. 282	Pauku e pili ana i ke Alenui	
Mk. 56	No. 282	"	Kihoholea Miana
No. 41	No. 34	"	"
Mk. 52	No. 368	"	"
Mk. 23	No. 22	"	"
Mk. 51	No. 200	"	"
No. 38	No. 116	"	" a hiki i ke kumu ulu
No. 44	No. 400	"	Kuhua
No. 35	No. 216	"	"
No. 41	No. 100	"	"
No. 55	No. 104	"	" a hiki i ke kiki mui. 1. 107 Eka

5 October 1852.

A. F. Sumner
Luna ana ana

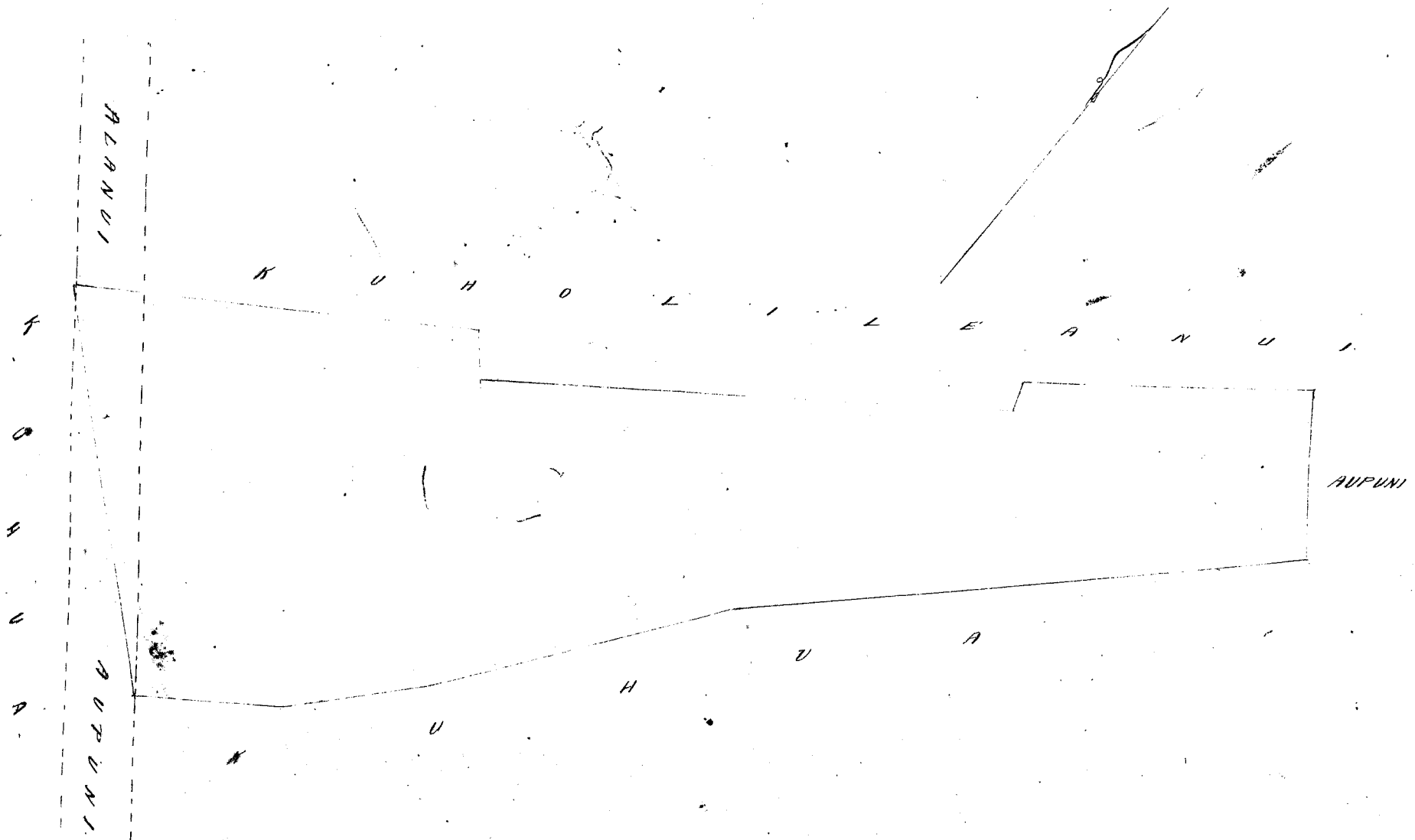

Scale 1 Chain an Inch.

Heleu 5843 Kahowaha (no Kookonua)

Ua hoi mai oia no kona Apama aina ma Kapuwai i Paua, Honolulu, ma Kona, ma ka Moku o Oahu; no ka mea, ua loa ia ia keia wahi no Kaulaui mai ka mahuakane o Keikemui i ka M.H. 1831, a ua noho keakea oleia a hiki i keia manawa.

Oia ka makou e hooke me no Kahowaha; he kuleana hoi kona malalo iho o ke Ano Alodio. Ina i uku mai oia i ke ke Aupuni hapaha; alaila, ua kupo ia ia ka Palapala Sila Alodio.

Pono mai ia ia ke uku no ka hookelele a me ka hookelele ana i ka olelo. Penei, -

W. L. Lee
S. M. Robertson
J. H. Smith
J. K. Kaulaui

No ka tumi a me ke pui ana i ka olelo ma ka Muepepa
No ke kope ana i ka olelo koia
No ka palapala keia
No ka hana ana i ka la 14 o Augate 1851
No ke kope ana i wa olelo a ma huike 1/3 Anao
No ke ana ana i ka la 22 o Augate 1853. Kaa ke ana 96.
No ke kope ana
No ka hookelele ana i ka olelo i ka la 27 o Augate 1853.

Eia ma palena.

Anaia e S. P. Kalama

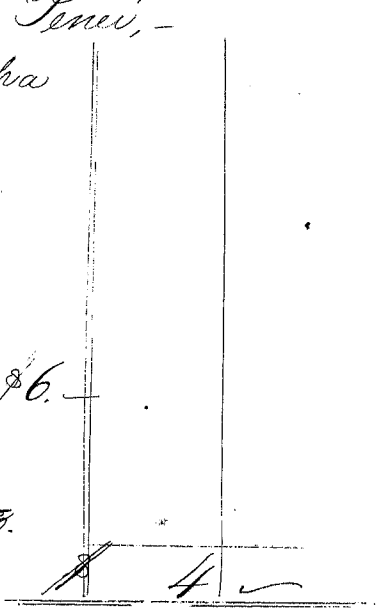

Ma Kapuwai, Paua, Honolulu, Oahu.

16 Poi me Nula u me Kulanahale. E hoomaka ma ke kiki Komohana Kona ma Kapuwai e pili ana me ka aina i oleloia no Kahaleiwi; - A e holo i ka Kona 88° 15' Kikina 257 Pahu e pili ana me Kahaleiwi; Alaila i ka Kona 32° Kikina 413 Pahu e pili ana me ka aina o ke Aupuni i keia mai e Paliukua a hiki i ka pohaku i haitonai x ma ke kiki Kikina o keia; - Alaila i ka Kona 45° 30' Kona 176 Pahu iho ilalo me ka aina o Kaauhau a hiki i ka pohaku me ma Kahawai; - Alaila holo i ka ma Kahawai arakua a hiki i ka hoomaka ana.

Eia ka Ni 1²⁵/₁₀₀ Eka.

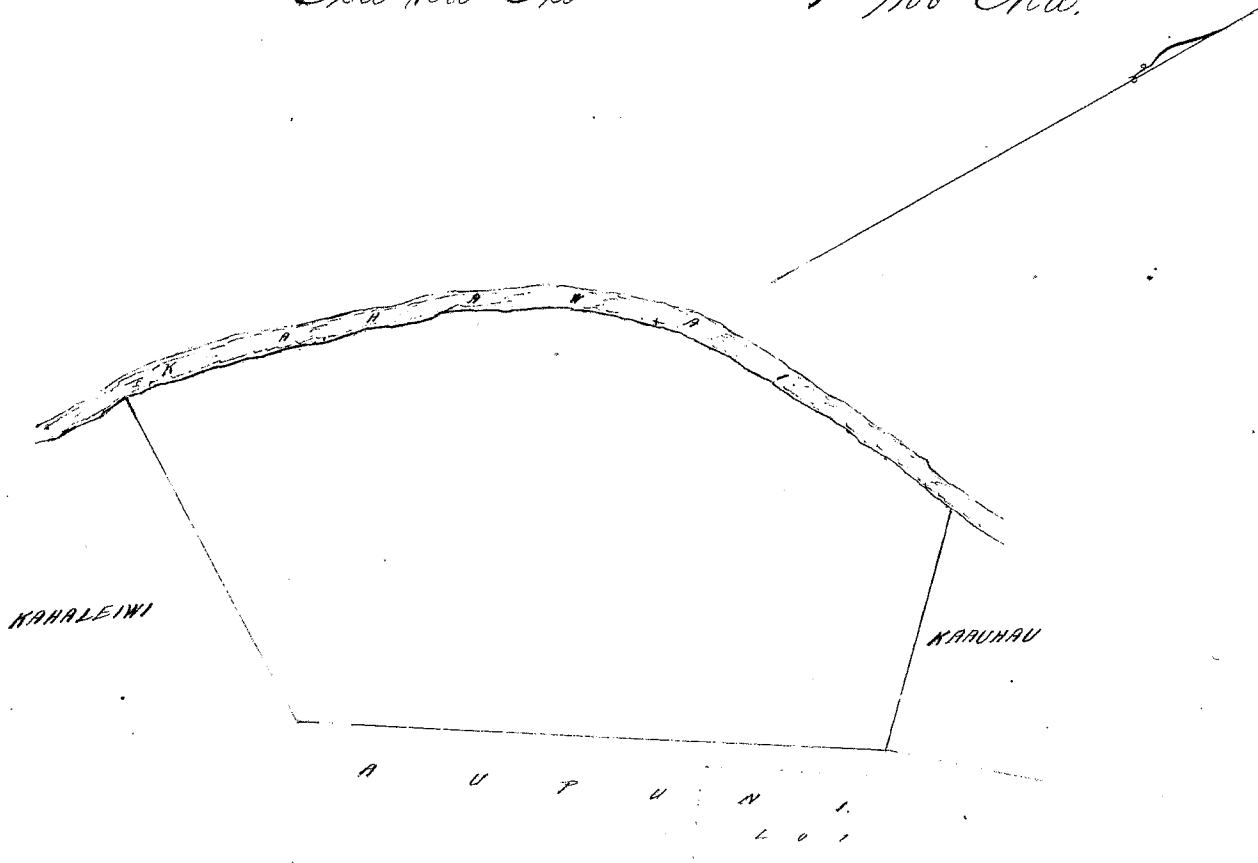

3/4 INCH = 100 PAHU
SCALE

Heleu 6024 Kaauhau (no Kookonua)

Ua hoi mai oia no kona mau Apama aina ma Kapuwai, Paua, i Honolulu, ma Kona, ma ka Moku o Oahu; no ka mea, ua loa ia ia keia mau wahi no Keikemui mai i ka wa e ola ana. Ina a ua noho keakea oleia a hiki i keia manawa.

Oia ka makou e hooke me no Kaauhau; he kuleana hoi kona malalo iho o ke Ano Alodio. Ina i uku mai oia i ke ke Aupuni hapaha; alaila, ua kupo ia ia ka Palapala Sila Alodio.

Pono mai ia ia ke uku no ka hookelele a me ka hookelele ana i ka olelo. Penei, -

No ka tumi a me ke pui ana i ka olelo ma ka Muepepa
No ke kope ana i ka olelo koia
No ka palapala keia

W. L. Lee
G. M. Robertson
J. H. Smith
J. Kekaulaha

No ka hana ana i ka la 30 o Augate 1853.
No ke kope ana i na olelo a na huike
No ke ana ana i ka la 22 o Augate 1853, Aa ke ana ana i ka la 16.
No ke kope ana
No ka hoholo ana i ka olelo i ka la 27 o Augate 1853.

Oia ma palena. Ania o S. P. Kalama

4

Ma Kapiwahi, Paua, Honolulu, Oahu

Maunani. Pahala. E hoomaka ma ka pohaku i hoaihana x ma ke hiki Kikina o keia aina, - u e holo
Maun 71° 30' Kom. 258 Pahu, hiki pohaku x lihi ma ka Alanaui, - me Kema 8° Kom. 140 Pahu ma lihi Alanaui, - me Kema
53° Kikina 172 Pahu, hiki pohaku oia ma Kahawai anao, - a me Maun 39° Kikina 207 Pahu, me Honolulu no Aupuni
a hiki i ka hoomaka ana,

Ka Ali 23/100 Eka.

Maunani 2. 17 Loi me Kula. E hoomaka ma ka pohaku ma Kahawai, hiki Honolulu o keia aina, e
pili ana me ka aina o Kahawaha, - a e holo Kema 45° 30' Kikina 176 Pahu pili me Kahawaha, - Alaila Maun
41° Kikina 75 Pahu ma ka palena, Kula me Aupuni a hiki pohaku x, - me Maun 8° 30' Kom. 36 Pahu, a me
Maun 88° 45' Kom. 67 Pahu, - me Kema 1 Maun 75° 15' Kom. 57 Pahu me Aupuni, - Alaila Maun 88° 45' Kom. 67
Pahu, me Kema 12° 15' Kom. 106 Pahu, - a me Maun 49° Kom. 157 Pahu e pili ana me ka aina o Kikina
a puka i Kahawai, - Alaila ikai ma Kahawai holohi a hiki i ka hoomaka ana, Ka Ali 145/100 Eka.

Ka Ali a pau 168/100 Eka

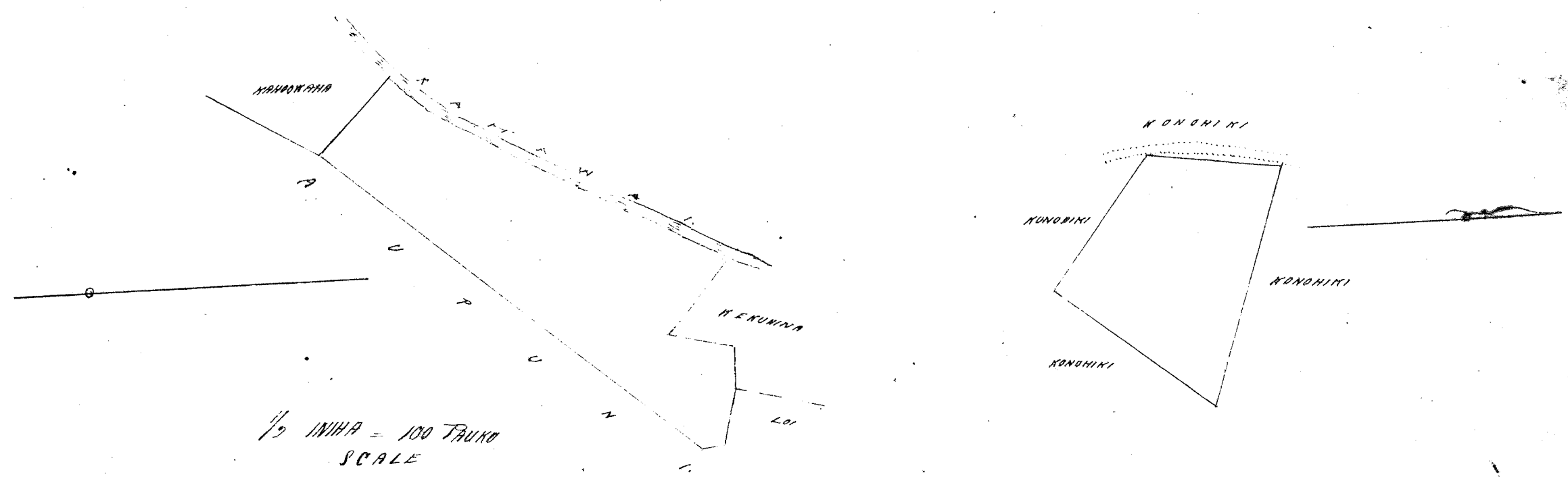

Kele 1124 Kalahouka

Ma hoi mai oia no keia Ahau aina ma Kawananakoa, Maunani, Honolulu, ma Kona,
ma ka Moku o Oahu, me ka mea, ua loaa i oia keia wahi me Kaaha mai ma keia maunani
mei i ka M. H. 1524, a ua noho keia olelo a hiki i keia manawa.

Oia ka anohu i hooke me ka Kalahouka, he kuleana i keia manawa iho o ke Amo Alodio. Ima
e uku mai oia i keia Aupuni hapaha, Alaila, ua hooke ia ia ka Palapala Ili Alodio.

W. L. Lee
G. M. Robertson
J. H. Smith
J. Kekaulaha

No ka hana ana i ka la 28 o June 1848
No ke kope ana i na olelo a na huike 1/2 Awa
No ke ana ana i ka la 16 o Maraki 1853
No ke kope ana
No ka hoholo ana i ka olelo i ka la 27 o Augate 1853.

Oia ma palena. Ania o S. P. Kalama

3

Apana ma Apana. Honolulu, Oahu.

Apana 1. Loi. E hoomaka ma ke kiki Kamaeha, a e holo Akau 45. Hikinua 47 Paku me Kamakela, Kema 70. Hikinua 15 Paku, Kema 41. Hikinua 72 Paku me Kohopa; Kema 24. 15. Kom. 31 Paku me S.D. Kuaiaia; Kema 35. 30 Kom 25 Paku me S.D. Kuaiaia; Akau 46. Kom. 81 Paku me S.D. Kuaiaia a hiki i kea hoomaka ana, Ka Ii 46 1000 Eka

Apana 2. Loi. E hoomaka ma ke kiki Hikinua o keia Loi ma ka auwai, a e holo Akau 79. 30 Kom. 50 Paku me Hikinua; Akau 40 Kom. 169 Paku me Hikinua; Kema 78 Kom. 15 Paku me S.D. Kuaiaia; Kema 56 Kom. 84 Paku me S.D. Kuaiaia; Kema 12 Kom. 34 Paku me S.D. Kuaiaia; Kema 45 Hikinua 209 Paku me S.D. Kuaiaia; Akau 47 Hikinua 136 Paku me Kuauna auwai a hiki i kea hoomaka ana, Ka Ii 28 100 Eka.

Apana 3. Loi. E hoomaka ma ke kiki Hikinua mauka o keia Loi ma ka kiki auwai, a e holo Akau 42 Kom. 267 Paku me S.D. Kuaiaia; Kema 15 Kom. 123 Paku me auwai; Alaila holo pulei ma ka palena i ae kikeia o Kamaka a me S.D. Kuaiaia 204 Paku, a hiki i ka palena kiki Pihala o laua, Alaila holo i uka ma Kuauna a hiki i kea hoomaka ana, Ka Ii 25 1000 Eka

Apana 4. Loi. E hoomaka ma ke kiki Akau o keia Loi e pili ana me Kohopa, a e holo Kema 47 Hikinua 118 Paku me Kohopa; Kema 16 Kom. 69 Paku me Kohopa; Kema 22. 30 Kom. 72 Paku me Nalaunio; Kema 68. 30 Kom. 35 Paku me Papaa; Akau 42 Kom. 130 Paku me Papaa. Alaila holo i uka ma ka auwai a hiki i kahi e kaha ai ke wai iloko o Kuaiaia; Alaila ae ma ka pili Lina Akau 20 Paku a hiki i kea hoomaka ana Ka Ii 23 100 Eka Lau Lau 808 1000 Eka

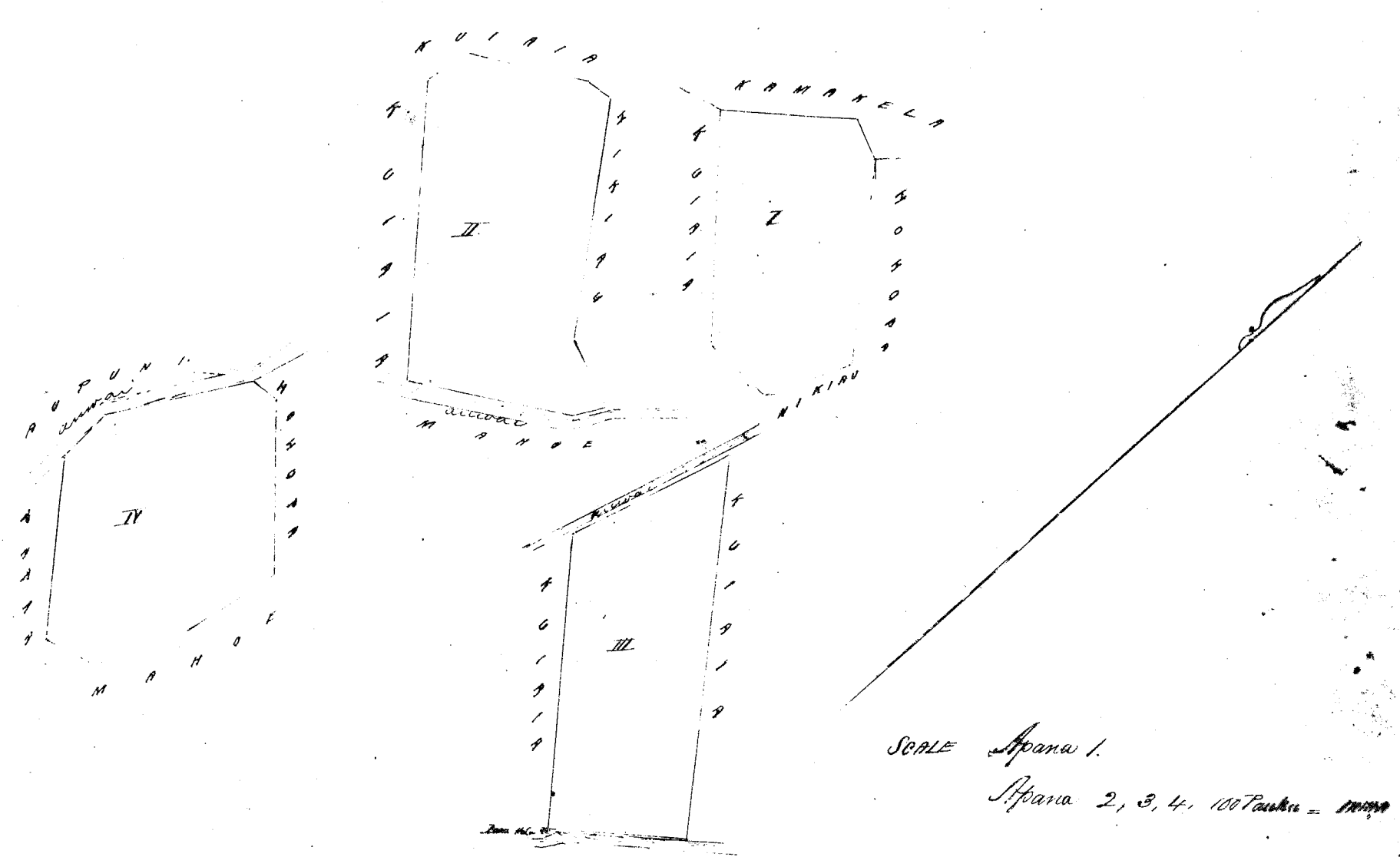

Heleu 3375 B Kuaumoana (no Kauhwa)

Ua hoi mai oia ma kona Apana aia ma Kamakela i Honolulu, ma Kona, ma ka Motupuni, Oahu, ma ka mea, ua loa ia keia Apana aia (no Kauhwa ua hiki i kono ma i Kuaumoana, a ua kuai aku o Kauhwa i keia loi ia Luiti) a ua noho keakea oleia a hiki i keia manawa.

Oia ka makou e hooke nei no Kuaumoana a ia Kauhwa a lilo aku ia Luiti; he kuleana ko laua ma kulo iho o Ke Aho Alodis. Aia e ukui mai laua i ke ke Uupuni hahaha; alaila, ua kufiono ia ia ke Palapala Sela Alodis. Iono ma ia laua i ke ukui me ka hoohelehele a me ka hoohele ana i ke olelo. Penei; -
No ka rami a me ke pai ana i ke olelo ma ka Mufepa
No ka kope ana i ke olelo kono
No ka palapala hii

W. L. Lee
G. M. Robertson
J. H. Smith
J. M. Kaulahao

No ka hana ana i ka la 25 o Maraki 1850.
No ke kope ana i ma olelo a ma hiki
No ke ana ana i ka la 23 o Iulai 1853. Haa ke ma \$3.00
No ka kope ana
No ka hana ana i ka la olelo i ka la 27 o Augato 1853.

2

Eia ma palena. Ania e S. P. Kalama

Apama 2. I Poi ma Kawakela Ili Honolulu, Oahu
E hoomaka ma ke hiki Heina o keia Poi. A e holo Akau 54 Kom. 251 Pautu e pili ana me
Kolelua; Alaila Akau 55 Hikiina 46 Pautu; a me Akau 50 Hikiina 36 Pautu e pili ana ma ke hiki Heina o ka
Auwau "Kunawai" a hiki i ka pihaku i hoailonaia 7. Alaila Heina 53 Hikiina 108 Pautu, a me Heina 62
Hikiina 113 Pautu e pili ana me Kolelua a me Hohopa. Alaila Heina 41' 30" Kom. 82 Pautu e pili ana
me Heina a hiki i ka hoomaka ana.

Eia ka Ili 214 Anana

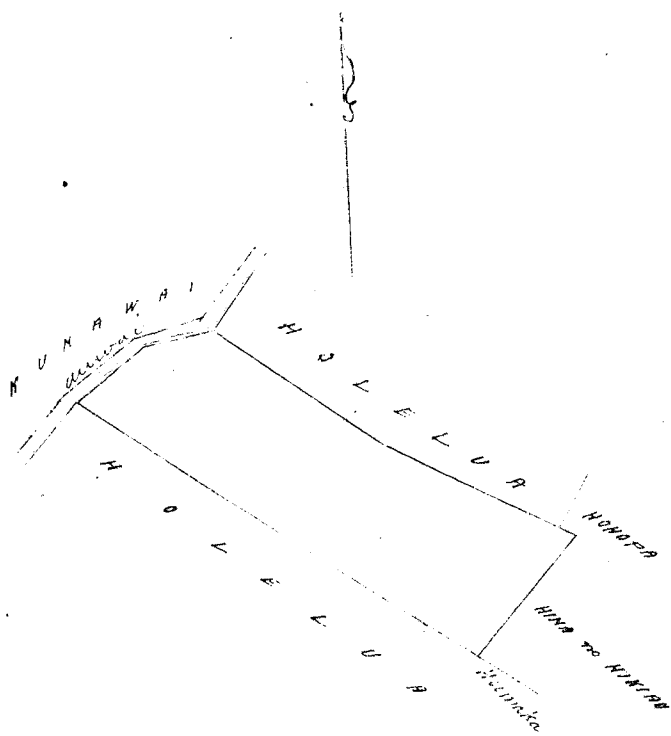

Kelu 3322 S. Sute

Apama 1

Ua koo mai oia no kona Pahale ma Honolulu ma kona ma ka Mokupuni o Oahu; ma ka
ma, ua loa ia ia keia wahi no Kalaimoku mai i ka makahiki 1826 manua aku o ka holo ana o Peki ma
i Sabiti, a ua moho keakea oia a hiki i keia manawa.

Oia ka makou e hooke nei no S. Sute, ke kulana hoi kona ma lalo iho o ke Awa Alodiu.
Ia e iho mai oia i keia Aupuni kapahe, alaila, ua kupo ia ia keia Palapala Ili Alodiu.

Poo mai ia ia keia iho no keia hooke holo a me ka hooke ana i ka olelo, Pemi
W. L. Lee
No ka hana ana a me kepai ana i ka olelo ma ka Muepa.

G. M. Robertson
J. H. Smith
J. M. Kaulahao

No ke kope ana i ka olelo hoi ma
No ka palapala hoi
No ka hana ana i ka la 7 o Iuni 1853.
No ke kope ana i ma olelo a ma hiki 1/3 Awa
No ke ana ana i ka la 13 o Augato 1853.

No ke kope ana
No ka hooke ana i ka olelo hoi i ka la 31 o Augato 1853.

4

Eia ma palena. Ania e W. H. Pease

Notes of Survey of a House Lot situated in the Ili called Kalaimoku, Honolulu, Oahu, belonging
to S. Sute

Commencing at the South easterly corner of this lot at an adobe fence, which forms
the boundary between this Lot and Pahale belonging to ^{W. H. Pease} ~~W. H. Pease~~, running from thence N. 46° 50' E. 110
Chains along an adobe wall to the corner of said wall, bounded by land belonging to W. H. Pease
from thence S. 45° 30' E. 2 1/2 Chains along an old adobe wall to a coral wall bounding the street called
the Palace Walk on its northerly side, thence N. 46° 50' E. 11 feet along said Palace Walk, thence N. 45° 30'

E. 2 1/100 Chains, passing over the line of an old adobe fence, bounded by Pahale belonging to Toki; thence N. 46° W. 1 1/100 Chains along an adobe wall bounded by said Pahale, belonging to Toki; thence N. 12° E. 2 1/100 Chains bounded by land belonging to the Govt.; thence S. 34° 45' E. 2 1/100 Chains along an adobe wall bounded by land belonging to Andrew Kuld from thence to point of commencement following an adobe wall and being bounded by land belonging to S. Kalama - Comprising an Area of One Rod & Twenty seven perches.

Honolulu August 13, 1853.

Erroneous calculation
 J. H. Pease
 Surveyor

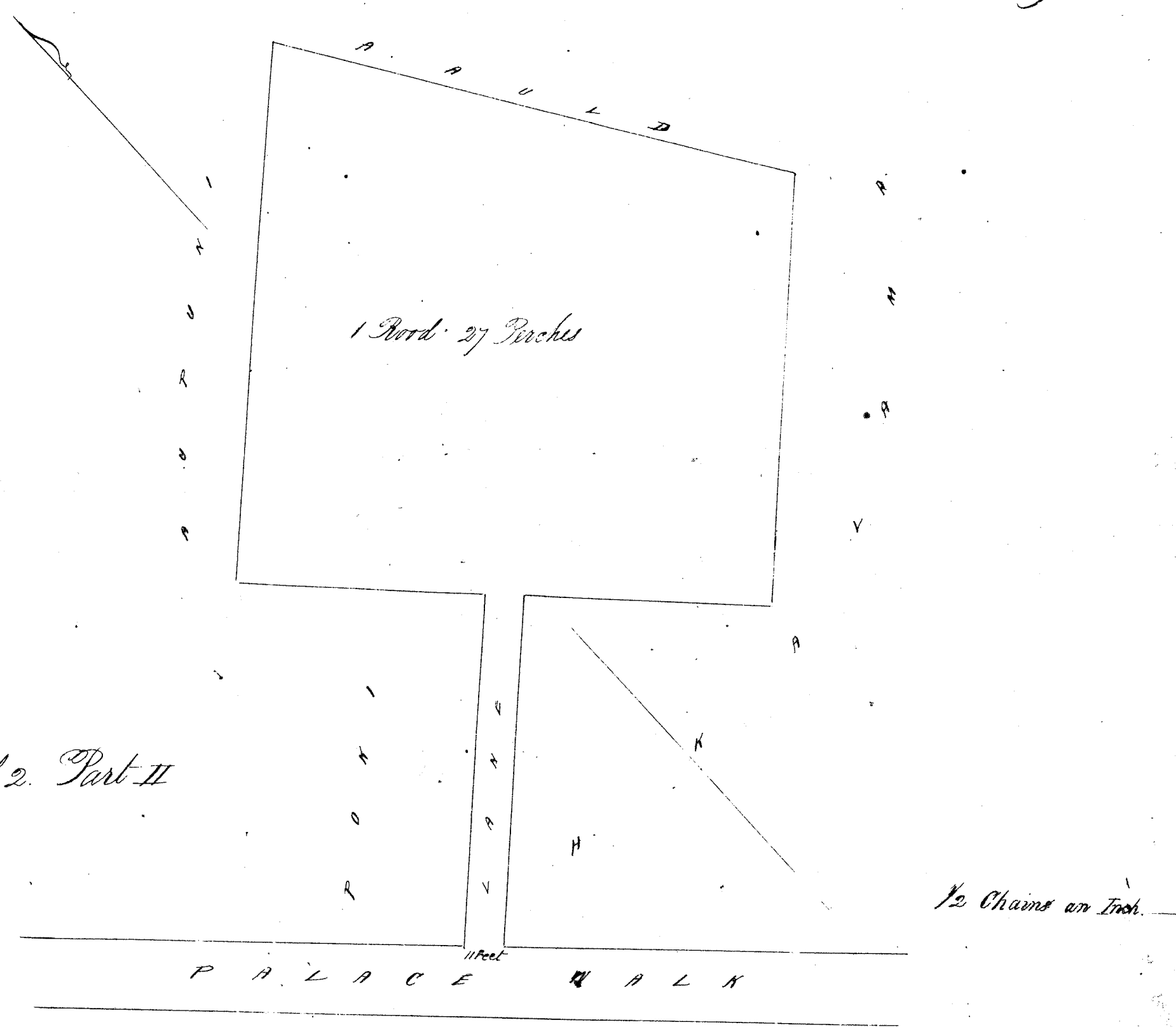

See Page 993 Vol. 2. Part II

Kele 1404 Nahuina

mai Aoo 815 Vol. 2. mai

Oia kei mai oia no kona Ahana aina ma Aala i Honolulu ma kona ma kea Mookupuni o Oahu, no ka mea, ua loaa ia ia keia wahi Ahana aina no Kamaiakuhuluhui mai i ka wa o Kamehameha a ua maha keakea oleia a hiki i keia manawa.

Oia kea makou e hoohe me o Nahuina; ke huleana hoi kona mualalo iho o ke Aoo Alodii. Ema e ukou mai oia i ke ke Aupuni kapaha; alaila, ua kupo ia ia kea Palapala Sila Alodii.

Pono nae ia ia ke ukou no ka hoohelelele a me ke hoohelelele ana i ka olelo; Penei,

- W. L. Lee
- G. M. Robertson
- J. H. Smith
- J. Kekaulaoo

- No ka ruuni a me ke pui ana i ka olelo ma kea Muepea,
- No ke kope ana i ka olelo keia
- No ke palapala kei
- No ke hana ana i ka la 9. October 1848.
- No ke kope ana i na olelo a na hoike 1/2 Aoo
- No ke ana ana i ka la 17. August. 1853.
- No ke kope ana
- No ke hoohelelele ana i ka olelo i keia la 4. October 1853.

	\$	Stn.
	3	00

Oia no palena.

Anaia e S. P. Kalama.

3 Loi ma Aala, Honolulu, Oahu.

E hoomaka ma ke kahi Komohana, a e holo Akau 32° Hikina 103 Paku, a Akau 48° 30' Kom 91 Paku, a Akau 27° Kom. 55 Paku, a Akau 5° Kom. 104 Paku ma ka lihi mauka o ka auwai me Fatimea ame Aupuni, Alaila Kema 85° Hikina 130 Paku, a Kema 78° 30' Hikina 58 Paku pili me ka Loi o Kalanikahua, Alaila Kema 14° Kom. 111 Paku, ame Kema 80° Hikina 193 Paku ma ka Loi o Kamaiha-hulipu, Alaila Kema 35° 30' Kom. 100 Paku, a Kema 25° Kom. 112 Paku pili me ka Loi o Keaka ma ka aina o Kema-kela ka inoa, Alaila Akau 76° Kom. 205 Paku ma ka lihi mauka o ka auwai me ka aina o Kalaimoku a hiki i ka hoomaka ana, Eia ka Ili 68/100 Eka.

S. P. Kalama
ana aing

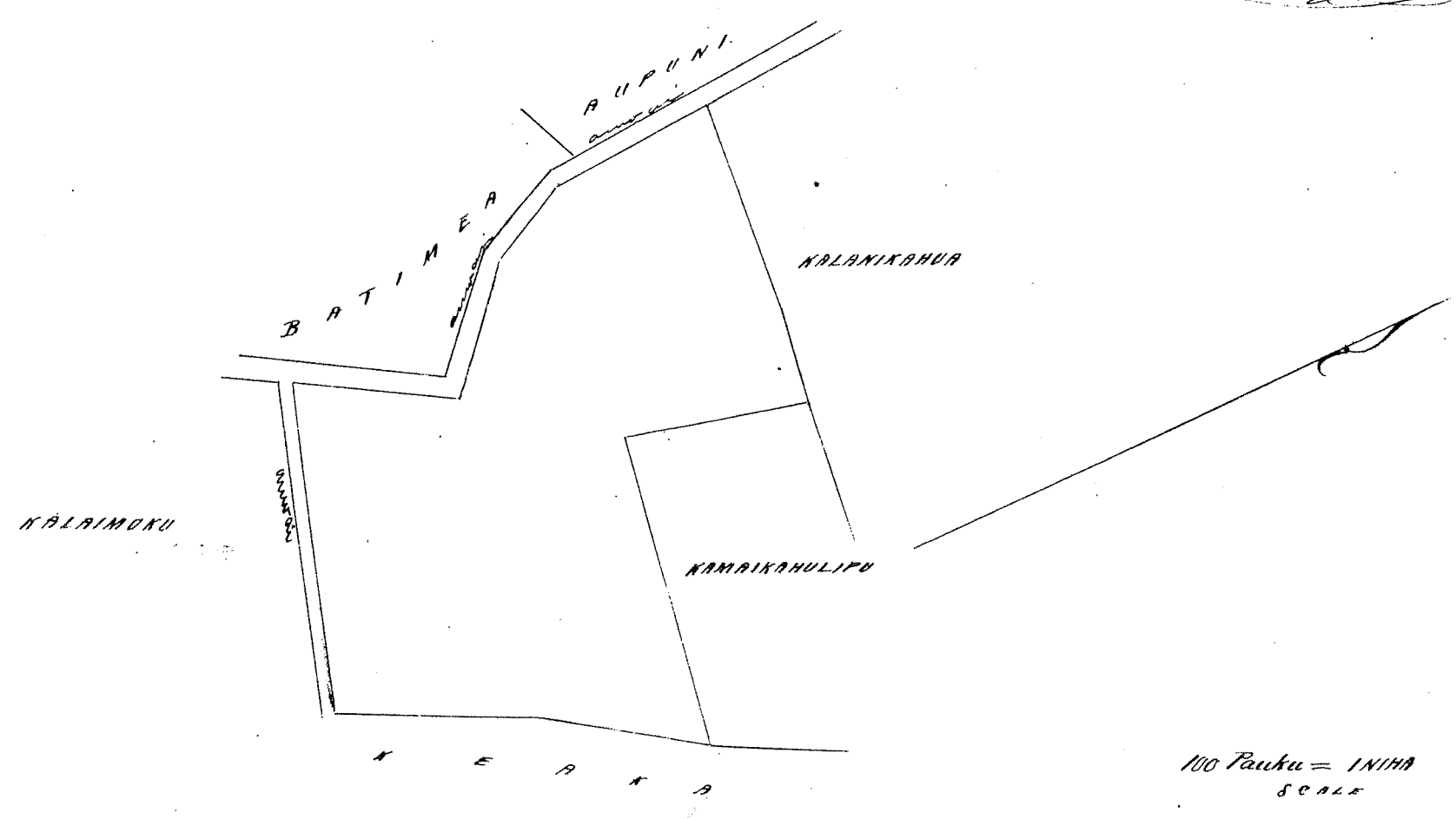

Kele 91 FL Kiniakua (no Keawekuaia)

Ma koi mai oia no kona Apana aina ma Puiwa i Honolulu ma Kona, ma ka Moku o Oahu, no ka mea, e like me na Kanawai o ka M.H. 1851 no na Aina Pahu; no ka mea, ua loa ia ia keia wahi no Kahuana mai mamua aku o ka mahe ana o Kaahumanui i ka M.H. 1832, a ua mau ka mohe ana a hiki i keia manawa, aku nei, ma ke iho nei i ka mau pumahu, a iho keia wahi ia Keawekuaia ke kahi a kona kaikuaana.

Pololei, ke hooke nei makou no Kiniakua a ia Keawekuaia; he kuleana hoi kona ma lalo iho oke Ano Alodio. Ina e uku mai oia i ke ke Aupuni papaha; alaila, kumpo ia ia ka Palapala Lila Alodio.

- Pono mai ia i ke uku no ka hoholoholo a me ka hoholo ana i ka olelo; Penei.
- W. L. Lee No ka rumi a me ke pui ana i ka olelo ma ka Muepa
- G. M. Robertson No ke kope ana i ka olelo koira
- H. Smith No ka palapala kii
- J. Kukanohoa No ka hana ana i ka law 10 o October 1853.
- No ke kope ana i ka olelo a na huike
- No ke ana ana i ka law 24 o June 1852.
- No ke kope ana
- No ka hoholo ana i ka olelo i ka law 10 o October 1853.

Eia ma palawia Aniaia S. P. Kalama

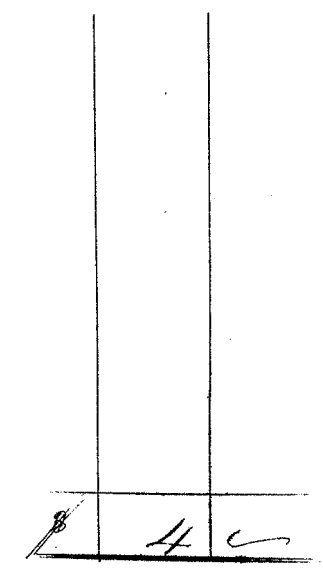

Puiwa, Nuuanu, Honolulu, Oahu.

5 Loi me Kula mahi ame Kale. E hoomaka ma ka pihaku x paa loa ma lalo o ka papohaku e pili ana me Nuuanu. A e holo Akau 47° Kom. 298 Paku ma ka papohaku e pale ana i wana o Puiwa a. Nuuanu e pili ana me ke kuleana o Kewa no Kaianu x, Alaila Akau 48° 30' Hikina 186 Paku poh x ame Akau 53° Hikina 217 Paku ma ka papohaku e pale ana i wana o "Laimi" no Kale, Alaila Kema 40° Hikina 378 Paku e pili ana me ka aina o ke Aupuni; Alaila Kema 46° 45' Kom. 242 Paku ma ka paku o Pakaona, Alaila Akau 44° Kom. 1 Kaulakau, ame Kema 48° Kom. 126 Paku ma ka paku o Luau i hiki i ka hoomaka ana Eia ka Ili 136/100 Eka.

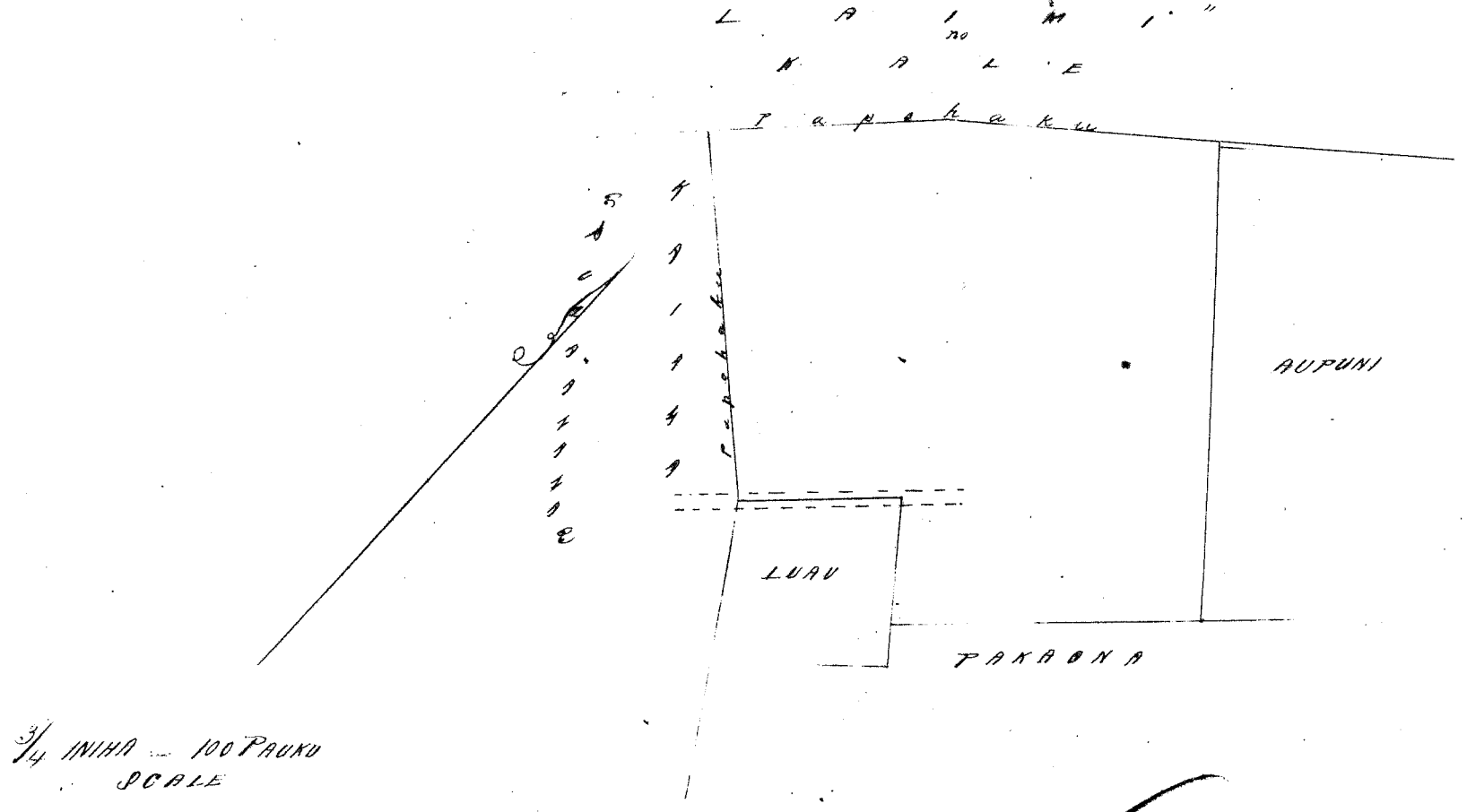

Hele 94 FL Takaona (no Kaupaa W.)

Ua koi mai oia no kona Apana aina ma Piiwa i Nuuanu Honolulu ma kona ma ka Mokupuni o Oahu, e like me na Kanawai o ka Makahiki 1851 no na aina Pahu, no ka mea, ua hoaa ia ia keia wahi no Kaupaa mui kona kaikohe amannu aku o ka muke ana o Kaakumanu i ka M. A. 1852, a ua noho oia malaila a hiki i kona make ana iho nei i keia mai puupuu liili, ili keia wahi i kanau wahine ia Kaupaa, a ke noho nei no oia malaila a hiki i keia manawa.

Oia ka makou e hooko me no Takaona a ia Kaupaa kana wahine, ke kuleana hoi kona malalo iho o ke Aow Alodis Ina e uku mui oia i kei ke Aupuni hapuwa, alaila, ua kuleana ia ia ka Palapala Lila Alodis.

Nono nae iwaia ke uku no ka hooholo ana i keia olelo, Penei.

- W. L. Lee No ka oumi a muke pua ana i keia olelo ma ka Maupapa.
- G. M. Robertson No ke kope ana i keia olelo koina
- C. H. Smith No ka palapala kii
- J. Kekaulahas No ka hana ana i ka la 10 o October 1853
- No ke kope ana i na olelo a wahi ke
- No ke ana ana i ka la 24 o June 1852.
- No ke kope ana
- No ka hooholo ana i keia olelo i ka la 10 o October 1853.

Oia na palena. Aina e S. P. Halama.

Piiwa, Nuuanu, Honolulu, Oahu.
 7 Loi me Kula o Hale. E hoomaka ma ke kiki Akau o keia aina ma ka pohaku puu loa iho hoailonaa x, - Alaila Hema 46° 45' Kom. 5 1/100 Kaulaha ma ka palena o ka aina Aupuni a me ka Kuniakua, Alaila Hema 44° Kikina 32' Pautu poh. x, - ame Hema 49° Kom. 40 Pautu, poh. x ame Hema 37° 30' Kikina 133 Pautu e fili ana me Luau ame Puahiki, Alaila Akau 42° 15' Kik. 40 Pautu me Puahiki, - ame Kila. Kaitituki Penana i ka 185 Pautu, ame Hema 41° Kikina 28 Pautu, ame Akau 58° 30' Kikina 75 Pautu, ame Hema 36° 30' Kikina 114 Pautu ma ka palena o Luau, - Alaila Akau 45° Kikina 96 Pautu ma ka Naimu, Alaila Akau 44° Kom. 27 Pautu, ame Akau 45° 15' Kikina 177 Pautu me Lililehua a hiki i ke kiki (Kikina) o keia aina, Alaila Akau 47° 15' Kom. 154 Pautu fili ana me Lililehua ame ka aina a ke Aupuni a hiki i ke hoomaka ana.
 Oia ka Ili 710 Eka

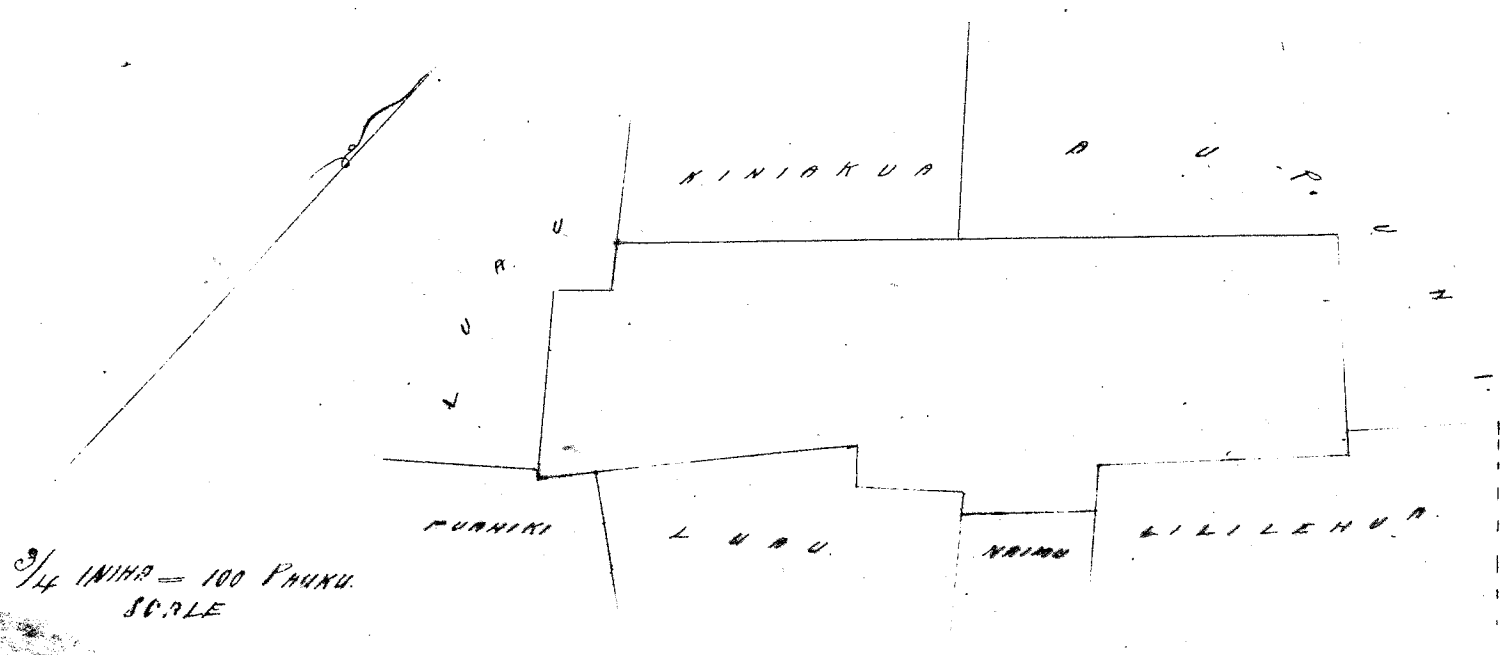

Helewa 2262 Luau

Ua koi mai oia no kona mau Apuna aia ma Piiwa Nuuanu i Honolulu, ma Kona, ma ka Mokupuni o Oahu; no ka mea, ua hoaa i ia keia mau wahi no Hawaii i ka M. H. 1839, a ua noho keakea oleia a hiki i keia manawa

Oia ka makou e hooke me i no Luau; he kuleana ho'i kona malalo iho o ke Aro-Abodi. Ima e hooke mai oia i ke ke Apuna kapaia, alaila, ua kupaia i ia keia Palapala oia Abodi.

Pono ma i ia keia ke ikeu no ka hooke kolo a me ka hooke ana i ka olelo. Penei:

- W. L. Lee No ka nani a me ke faai ana i ka olelo ma ka Mafepa
- G. M. Robertson No ke kupa ana i ka olelo koina
- J. H. Smith No ka palapala i keia
- J. Kekaulaha No ka hana ana i ka la 21 o Auguli 1850.
- No ke kupa ana i ma olelo a ma hiki
- No ke ana ana i ka la 14 o June 1853.
- No ke kupa ana
- No ka hooke ana i ka olelo i ka la 10 o October 1853.

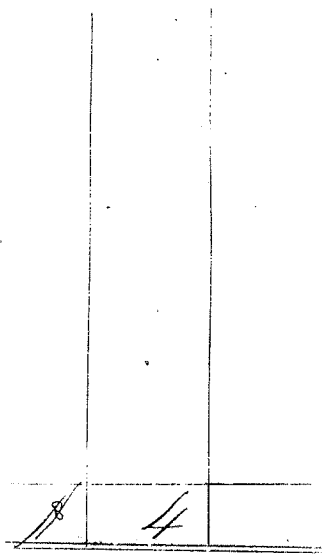

Eia ma palena. Anai i S. P. Kalanooa.

Piiwa, Nuuanu, Honolulu, Oahu.

Ap. 1. Loi me Kula. E hoo waka ma ke kahi Kona o keia apuna aia ma ka papohaku o Manuella, a e holo ka 34° 30' Kom. 113 Paku, me Kona 51° Kom. 36 Paku, me ka 36° Kom. 147 Paku, me ka 64° 15' Hikiina 39 Paku, me ka 32° Kom. 194 Paku, me Kona 38° Kom. 32 Paku, a me ka 49° Kom. 38 Paku ma ka palena o Puahiki, Alaila ka 42° 15' Hikiina 165 Paku, me Kona 41° Hikiina 28 Paku, me ka 50° 30' Hikiina 75 Paku ma ka palena o Pakaona, Alaila Kona 36° 30' Hikiina 200 Paku me Pakaona a me Naimu, Alaila Kona 61° Kom. 46 Paku, a me Kona 36° 30' Hikiina 169 Paku pili me Lililehua, Alaila Kona 45° 15' Kom. 101 Paku a me Kona 35° 30' Hikiina 70 Paku pili ma me ka Kona a hiki i ka papohaku, Alaila Kona 62° Kom. 87 Paku me Manuella a hiki i ka hoo waka ana, Eia ka Ili 110 Eka.

Ap. 2. Loi me Kula. E hoo waka ana ma ka papohaku i hoaitonia x ke kahi Kona o ka aia o Kuniakua e pili ana me "Punananana", a e holo ka 48° Hikiina 126 Paku, me Kona 44° Hikiina 132 Paku e pili ana me Kuniakua a me Pakaona a hiki i ka papohaku paa i hoaitonia x, Alaila Kona 49° Kom. 40 Paku hiki i ke kahi papohaku paa x ma ka ae, a me Kona 37° 30' Hikiina 124 Paku ma ka palena o Pakaona, Alaila Kona 51° Kom. 111 Paku ma ka palena o Puahiki a hiki i "Punananana", Alaila ae a holo ma ka papohaku me Kona no Hawaii ma "Punananana" a hiki i ka hoo waka ana
 Eia ka Ili 380 Anana

Pau loa ka Ili 1 Eka 259 Anana.

3/4 INCH = 100 PAKU
SCALE

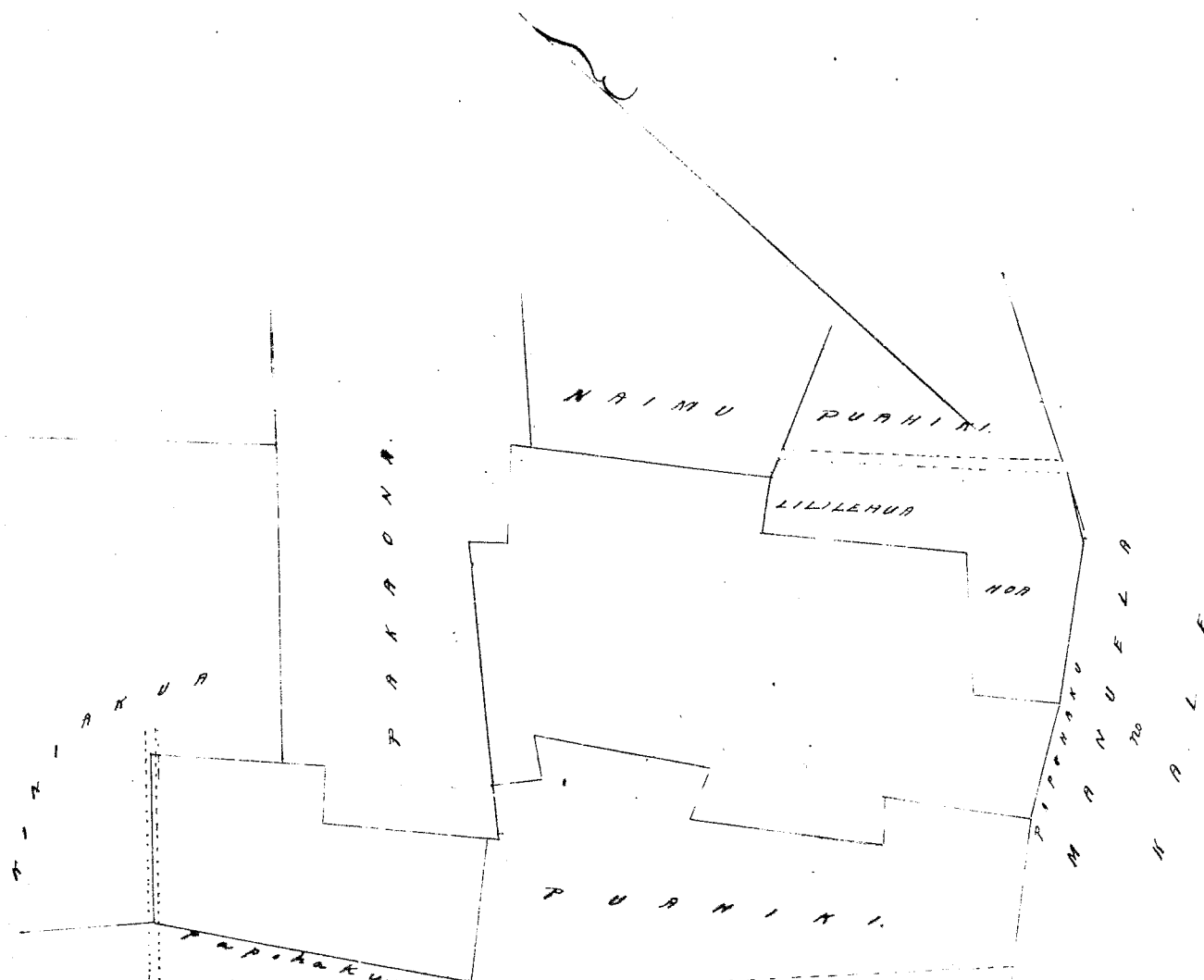

Helu 1325 Nakea

Ua koi mai oia no kona Apana aina ma "Punaanana" Nuuanu i Honolulu, ma Kona, ma ka Mokupuni o Oahu; no ka mea, ua loa ia ia keia wahi no Kaliaheana mai ika M. A. 1831, a ua noho keakea oleia a hiki i keia manawa.

Oia ka makou e hoko nei no Nakea; he kuleana hoi kona malalo iho o ke Aunui Alodia. Ina e uku mai oia i ke ke Aupeuni hapaha; alaila, ua kupo ia ia ka Palapala Sila Alodia.

- | | |
|-----------------|--|
| W. L. Lee | No ka rumi a me ke pua ana i ka olelo ma ka Nupupa |
| G. M. Robertson | No ke kope ana i ka olelo koina |
| J. H. Smith | No ka palapala kii |
| J. Kekaulaha | No ka hana ana i ka la 15 o Sepatemaba 1848 |
| | No ke kope ana i ka olelo a ma hooke 1/2 Awa |
| | No ke ana ana i ka la 6 o Dekemaba 1852. |
| | No ke kope ana |
| | No ka hoko ana i ka olelo i ka la 11 o October 1853. |

Oia ma palena. Anaia e S. P. Kalama.

Ma Punaanana, Nuuanu, Honolulu, Oahu.

He Kahuahala, me Kula, amu Awa Kalo. E hoomaka ma ka pohaku kuauna o keia a me ke Kanakahou, a e neenee aku i 40 Paku me Kanakahou a i ka hiki Kahawai wai-kake malia. Alaila Akau 65° 30' (Hikina) 1 Kaulaha ma Kahawai a hiki i ke Mahinealii. Alaila Akau 24° Kom. 218 Paku e pui ana ma ka pali a i ka pohaku ma ke Alalilii, a Akau 40° Kom. 938 Paku e pui ana ia mau awa me ke Mahinealii a hiki i ka papohaku o Kale. Alaila Kema 35 Kom. 239 Paku ma ka pua o Kale a i ke Moo. Alaila Kema 42° 15' (Hikina) 414 Paku, me Kema 37° 45' (Hikina) 356 Paku e pui ana me ke Moo a hiki i ka pohaku x. Alaila ike ma ka pali e makele papakahu ana i ma Loi o keia a me Kanakahou i ae likeia e lawa a hiki i ka hoomaka ana.

Eia ka Ii 2 46/100 Eka.

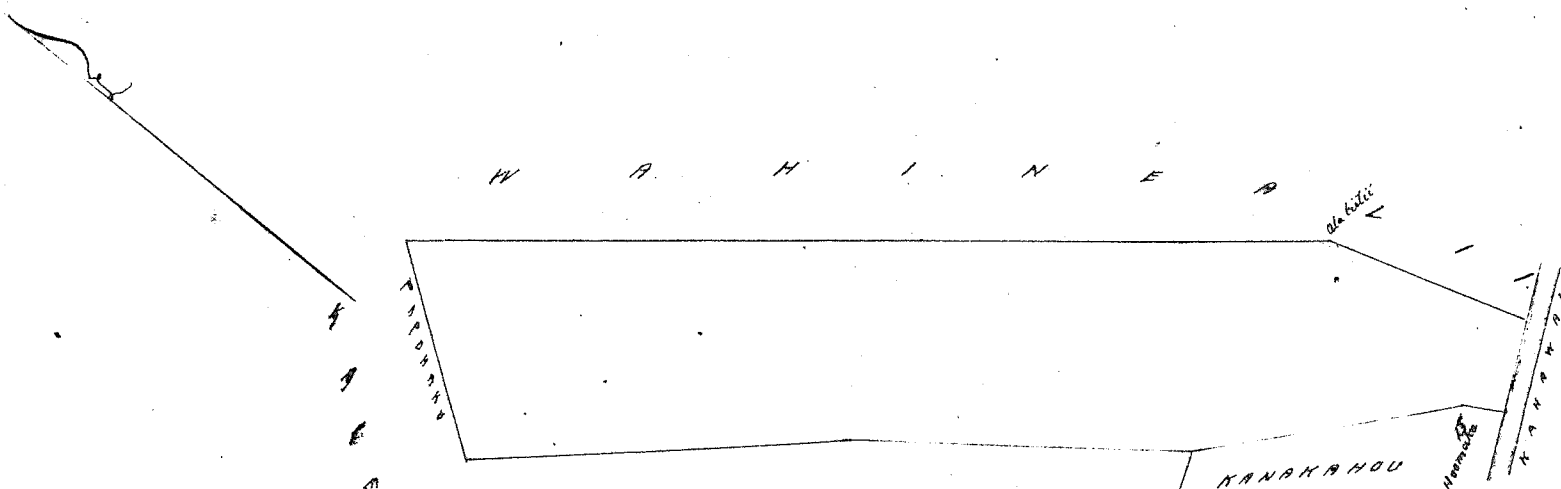

200 Paku = INHA.

Helu 1341 Kanakahou.

Ua koi mai oia no kona Apana aina ma Punaanana, Nuuanu, Honolulu, ma Kona, ma ka Mokupuni o Oahu; no ka mea, ua loa ia ia keia Apana aina no Kaliaheana mai i ka wa o J. A. Kuakini a noho ana ma ka Pahu i ka M. A. 1831, a ua noho keakea oleia a hiki i keia manawa.

Oia ka makou e hoko nei no Kanakahou; he kuleana hoi kona malalo iho o ke Aunui Alodia. Ina e uku mai oia i ke ke Aupeuni hapaha; alaila, ua kupo ia ia ka Palapala Sila Alodia.

Pono ma ia ia ke uku no ka hoko ana a me ka hoko ana i ka olelo. Penei,

- | | |
|-----------------|---|
| W. L. Lee | No ka rumi a me ke pua ana i ka olelo ma ka Nupupa |
| G. M. Robertson | No ke kope ana i ka olelo koina |
| J. H. Smith | No ka palapala kii |
| J. Kekaulaha | No ka hana ana i ka la 18 o Sepatemaba 1848 |
| | No ke kope ana i na olelo a ma hooke 1/2 Awa |
| | No ke ana ana i ka la 6 o Dekemaba 1852. |
| | No ke kope ana |
| | No ka hoko ana i ka olelo ma ka la 11 o October 1853. |

Anaia e S. P. Kalama

Ma Punaana, Muanu, Honolulu, Oahu.

Kula, Kulanahele, ame ana Kalo. E hoowaka ma ka pohaku kuauna o keia a me ka Nakea... Alaila Kema 65° 30' Kom. 193 Pautu ma ka lihi wai kehe male o Kahawai pili ana me ka Nakea... Alaila Kema 51° 45' Kom. 178 Pautu e pili ana i w mau aao me ka ana o Moa a hiki i ka papohaku o Pilipi... Alaila Kema 40° Kom. 159 Pautu e pili ana ma ka pali a i ka pohaku... Alaila Kema 51° 45' Kom. 166 Pautu ma ka lihi kae pali a i ka pohaku oioi... Alaila Kema 39° 15' Kom. 247 Pautu a i ka papohaku... Alaila Kema 51° 45' Kom. 178 Pautu e pili ana i w mau aao me ka ana o Moa a hiki i ka papohaku o Pilipi... Alaila Kema 31° Kom. 25 Pautu, ame Kema 41° Kom. 152 Pautu e pili ana me ka papohaku o S. Phillips a hiki i ke kiki Kema o ka Pahala o Kaa ma ke Ala liliu... Alaila Kema 39° 15' Kom. 222 Pautu, a Kema 42° Kom. 283 Pautu e pili ana me ka Kaa a hiki i ka pa o Keoni Ana... Alaila Kema 26° Kom. 108 Pautu, a Kema 30° Kom. 129 Pautu e pili ana me ka papohaku o Keoni Ana a hiki i ka Upawa ana o Moo... Alaila Kema 40° 15' Kom. 718 Pautu, me Kema 69° Kom. 64 Pautu e pili ana me Moo a hiki i ka pohaku... me Nakea, Alaila iho ma ka pali e mahete kapakahi ana i ma Loi o keia me Nakea i ae likeia e laua a hiki i ka hoowaka ana... Eia ka Ili 2 Iho Eka.

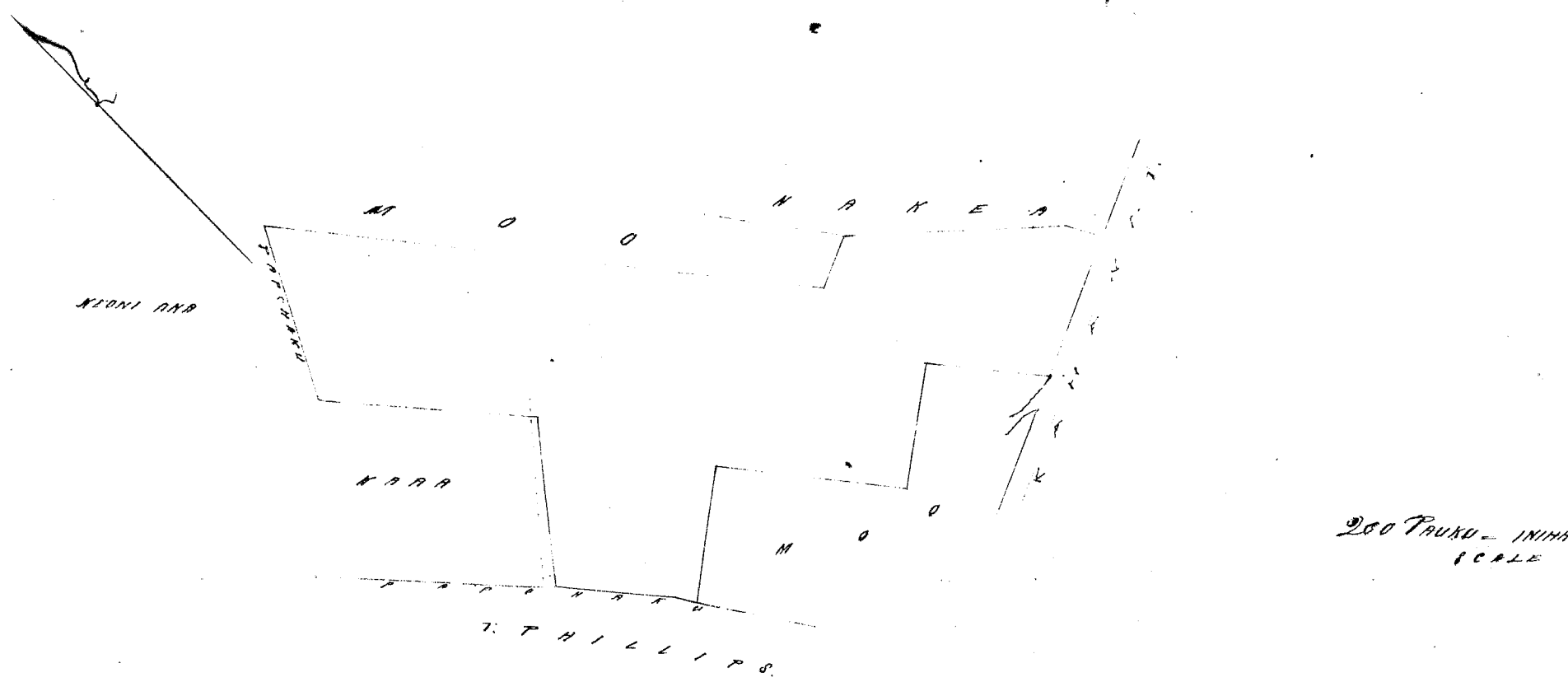

Selw 1471 Kakinialii

Ua hoi mai oia no kona Upawa ana ma Punaana, Muanu, Honolulu, Oahu no ka mea, ua loaa iaia keia wahi no Kakinialii mai i ka wa o J. A. Kuakini e noho ana i ka Papei i ka M. K. 1831, a ua noho keakea oleia a hiki i keia manawa.

Oia ka makuu e hooke nei no Kakinialii; ke kuleana hoi kona malalo iho o ke Ano Alodio. Ima e uku mai oia i ke ke Aupuni hapaha; alaila, ua kumpo ia ia ka Palapala Sila Alodio -

- Pono mai ia ia ke uku no ka hooholokolo a me ka hooholo ana i ka olelo Penei,
- W. L. Lee No ka rumi a me ke puu ana i ka olelo ma ka Kupepa
- G. M. Robertson No ke kope ana i ka olelo koina
- J. H. Spritt No ka palapala kii
- J. Kakaikaha No ka hana ana i ka la 13 o Dekemaba 1858
- No ke kope ana i ka olelo a ma hoike
- No ka ana ana i ka la 6 o Dekemaba 1852.
- No ke kope ana
- No ka hooholo ana i ka olelo koina ma ka la 12 o October 1853.

Eia ma palena. Anaia e S. P. Kalama.

4

Ma Punaana, Muanu, Honolulu, Oahu.

Kula mahiai ame ana Kalo. E hoowaka ma ke kiki Kema o keia ana ma Kahawai e pili ana ko Nakea... Alaila Kema 24° Kom. 218 Pautu e pili ana ma ka pali hanahana a i ka pa... Alaila Kema 40° Kom. 938 Pautu e pili ana mau aao me ka Nakea a hiki i ka papohaku o Kala... Alaila Kema 44° Kom. 212 Pautu e pili me ka pa o Kala; Alaila Kema 43° Kom. 774 Pautu, - ame Kema

22° 15' Hikina 307 Pautu, - a me Kemā 24° Hikina 151 Pautu e fili ana ia mau aoao me ke Kekoa no
Kaiāma a hiki i Kahawai, - Alaila Kemā 65° 30' Kom. 137 Pautu mau Kahawai a hiki i ka hoomaka ana,
Eia ka Ii 2 1/2 Eka.

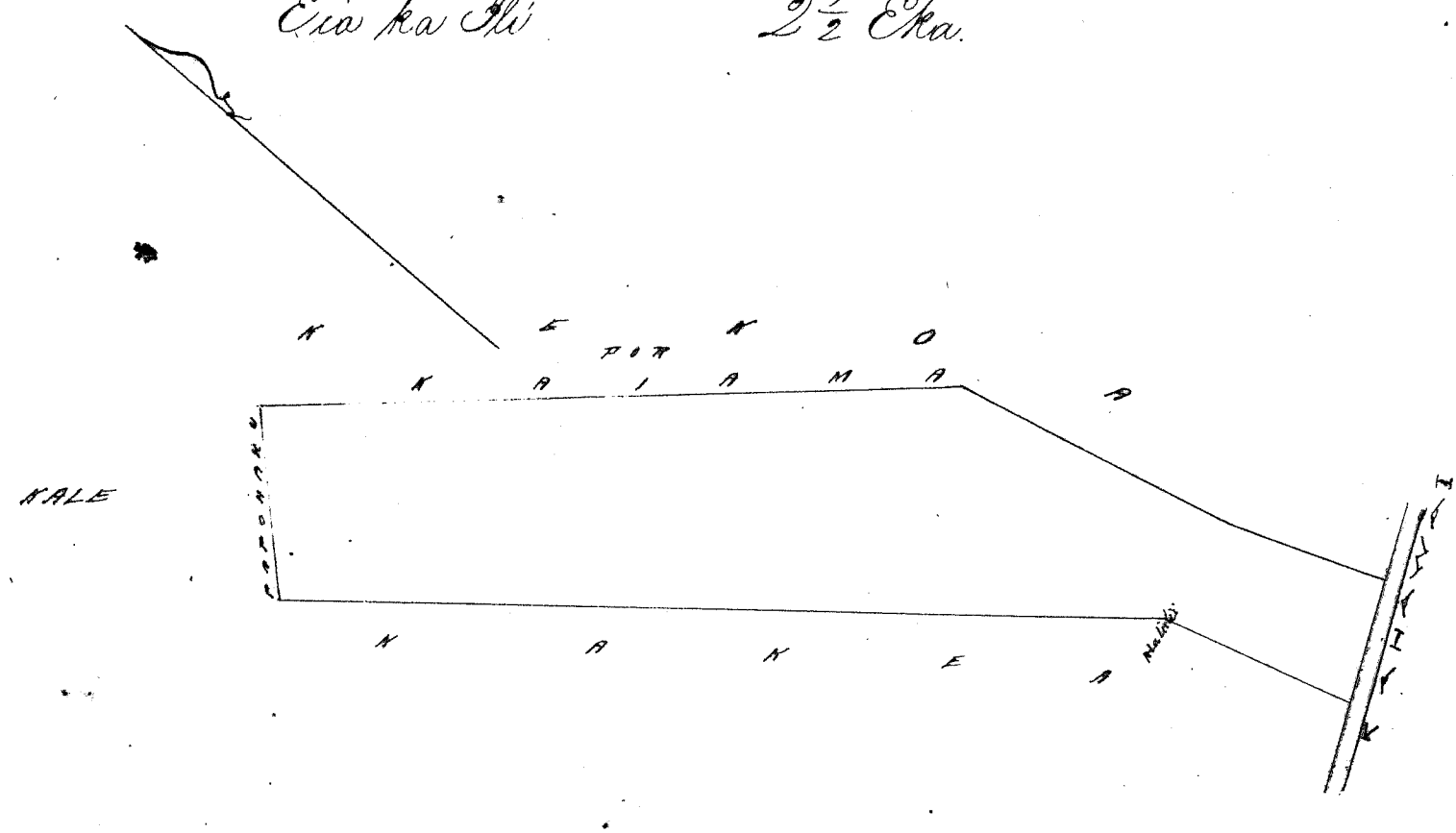

Ukūpaūloa

Ua hōkai hōwa i keia mau laina, a ia ka pono
ma ka mau, e like me ka māse ana.
J. P. K.

Honolulu October 12, 1853.

Heleu 1799 Kekoa

Ua kōi mai oia no kona āpana āina ma Punaānana, Nuuanu, Honolulu, ma Kona, ma
ka Mokupuni. Oaku, no ka mea, ia hōa ia ia keia wahi no Kalieheana mai mānuā aku o ka M. K. 1855,
a ua nōho keakea oia a hiki i keia mānawa.

Oia ka mākau e hōko nei no Kekoa, he hūleāna hōi kona mālalō iho o ke Ano Alodis. Ina e
ukū mai oia i ke ke Aupuni hapaha, alaila, ua hūpono ia ia ka Palapala Sila Alodis.

Pono nā ia ia ka ukū me ka hōhōlo kōlo a me ka hōhōlo ana i ka olelo, Pene

- W. L. Lee
- G. M. Robertson
- J. H. Smith
- J. Kēkēhāhae

- No ka ouini a me ke pāi ana i ka olelo ma ka Nūpepa
- No ke kōpe ana i ka olelo kōina
- No ka palapala kii
- No ka hana ana i ka la 16. Substansi 1853.
- No ka kōpe ana i mā olelo a mā hōke 13 āoao.
- No ka ana ana i ka la 6. Dekemaba 1853.
- No ke kōpe ana
- No ka hōhōlo ana i ka olelo i ka la 12. October 1853.

Eia na palena. Anaia e J. P. Kalama.

Punaānana, Nuuanu, Honolulu, Oahu.

Kula māhi a me āina Kalo. E hōmaka ma ka pohaku x ma ka uaskee o ke Kahawai e
fili ana me ke Puahiki ma Pūiwa, - Alaila Akau 22° Kom. 168 Pautu a hiki i ka pohaku x mākau o
ka pohaku nui, hiki Kemā o ka āina o Mānūela, - Akau 45° Kom. 492 Pautu a hiki i ka anahua o ka
Lōi me ke Kula no Puahiki, - Akau 43° Kom. 441 Pautu, fili ia mau aoao me Puahiki a me Mānūela a
hiki i ka Luau, - Alaila Akau 44° Kom. 248 Pautu fili me Luau a hiki i ka poh. x ma ke Alani, - Alaila Akau
47° Kom. 295 Pautu fili me Kūniakua a hiki i ka papohaku me Kale, - Alaila Kemā 49° Kom. 70 Pautu, -
Kemā 63° 45' Kom. 52 Pautu, - Kemā 48° Kom. 70 Pautu ma ka papohaku me Kale, - Alaila Kemā
43° Hikina 774 Pautu, - Kemā 22° 15' Hikina 307 Pautu, Kemā 24° Hikina 151 Pautu fili me Kūniakua a
hiki i Kahawai, - Alaila ma Kahawai a hiki i ka hōmaka ana.
Eia ka Ii 4 1/2 Eka.

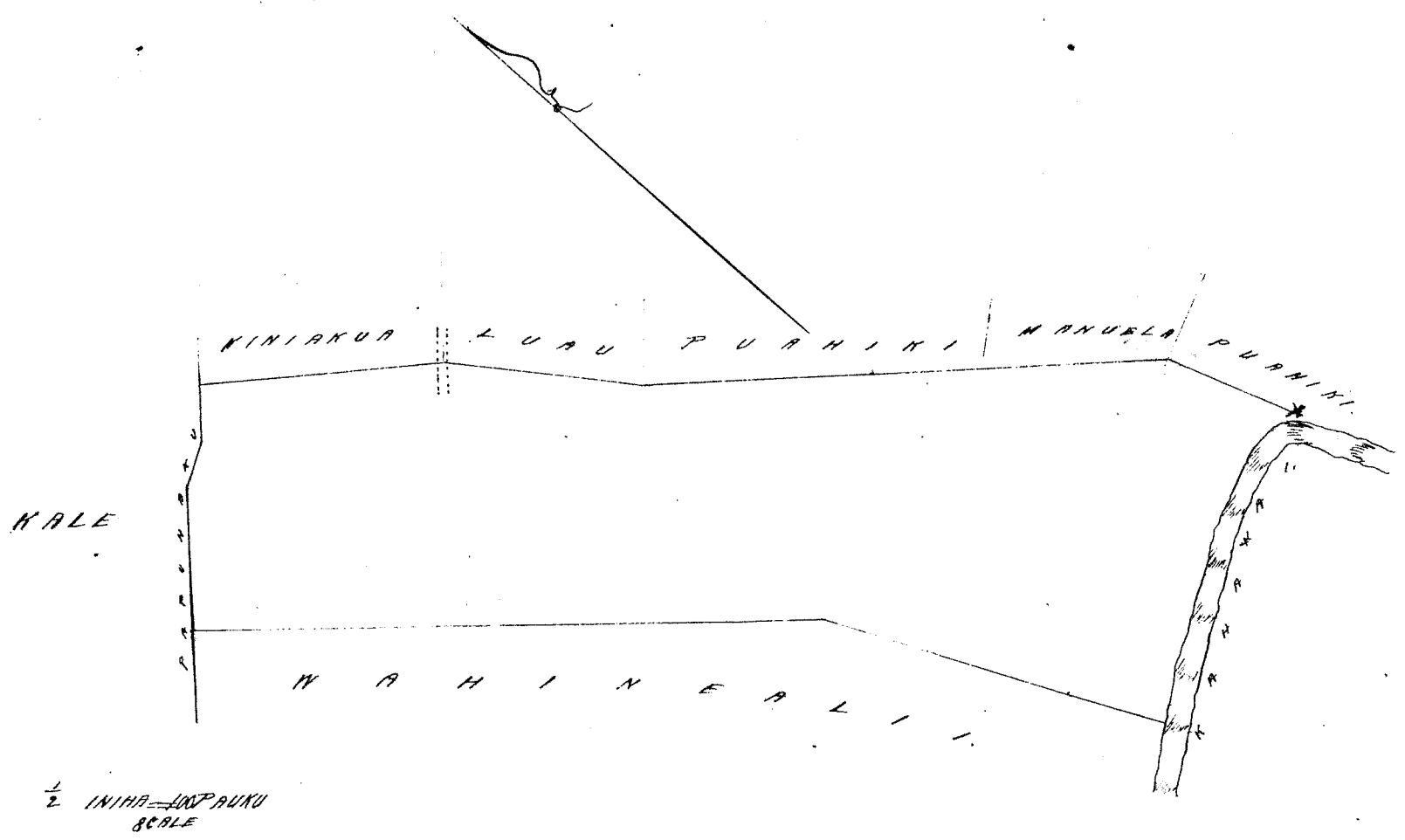

Hele 63 FL Kamai

Ua hoi mai oia no kona mau Apama aiaa ma Auwili i Honolulu, ma Kona, ma ka Mokupuni o Oahu; a like me na Kanawai o ka makahiki 1851 no na aiaa Pape; no ka mea, ua loaa ia ia keia wahi no na makua mai o kana kane mahope iho o ka make ana o kana kane i ka M. H. 1848, a no na anakua mai hoike kana kane mamua aku o ke kama ma Auwai i ka malama o Sepatemaba 1854, a ua noho keakea oia a hiki i keia manawa.

Oia ka makou e hooke me no Kamai; he kuleana hoi kona malalo iho o ke Ano Alodis. Ina e uku mai oia i ke ke Aupuni hupaha; alaila, ua hupana ia ia ka Palapala Sela Alodis.

Pono mai ia ia ke uku ma ka hookolokolo a me ka hookolo ana i ka olelo. Penei:-

- W. L. Lee
- G. M. Robertson
- O. H. Smith
- J. M. Kaulakas

- No ka rumi a me kepai ana i ka olelo ma ka Muepau
- No ke kope ana i ka olelo koma
- No ka palapala hii
- No ka hana ana i ka la 22 o Novemba 1852.
- No ke kope ana i na olelo a na hoike
- No ke ana ana i ka la 7 o October 1853.
- No ke kope ana
- No ka hookolokolo i ka la 12 o October 1853.

Eia na palena. Anaa e S. P. Kalamo.

4

Aiaa ma Auwili, Honolulu, Kona, Oahu.

Ap. 1. Kahuahale me 1 Loi. E hoomaka ma ka pihaku hoike ke kea ma ke pua maika o ke Kahuahale maika kahiko, e pili ana me ka pua aiaa, oia ke kiki Akau no ka aiaa kula o Keelaha ma, - A e holo Kona 1st 45th Hikiina 78 Pautu e pili ana me ke Keelaha, - Alaila Akau 59th Hikiina 70 Pautu e pili ana me ke Aupuni, - Alaila Akau 31st Kom. 2 Kaulakas 91 Pautu e pili ana me ke Kahuahale a me ka Loi o Hinaiuka, - Alaila Akau 63rd Kom. 83 Pautu. a Akau 79th 30th Kom. 1 Kaulakas 13 Pautu e pili ana me ka lili maika o ka auwai o ka Loi o Hinaiuka a hiki i ka auwai e holo ana i na Loi o Kawela, - Alaila Kona 25th Kom. 52 Pautu, me Kona 52nd Kom. 70 Pautu ma ka lili Kona o ka auwai o Kawela ma a hiki i ke kahi Loi o Iawa, - Alaila Kona 43rd Hikiina 3 Kaulakas 42 Pautu e pili ana me ka Loi o Kawela a me ke Kahuahale a hiki i ka pihaku maika pihaku kahiko, ka palena o "Kahuahale" kula no Keelaha ma, - Alaila Akau 57th 45th Hiki. 1 Kaulakas 54 Pautu ma ka pua aiaa o pili ana me ka aiaa o Keelaha ma a hiki i ka hoomaka ana. Eia ka Ili 1100 Eka.

Apama 2 1 Loi. E hoomaka ma ke kiki Kona e pili ana me ka Kona ma, A e holo Kona 1st 45th Hikiina 82 Pautu e pili 1 Kaulakas 83 Pautu, me Akau 52nd 15th Hikiina 52 Pautu e pili ana me ka auwai. Alaila Kona 33rd Hikiina 1 Kaulakas 72 Pautu e pili ana me ka Loi o Keelaha ma, Alaila Kona 57th 30th Kom. 1 Kaulakas 47 Pautu e pili ana me ka Loi o Kawela o hiki i ka hoomaka ana. Eia ka Ili 1100 Eka.

Scale Sp. 1. 1 INCH = 100 FATH

, 2. 1 1/2 . "

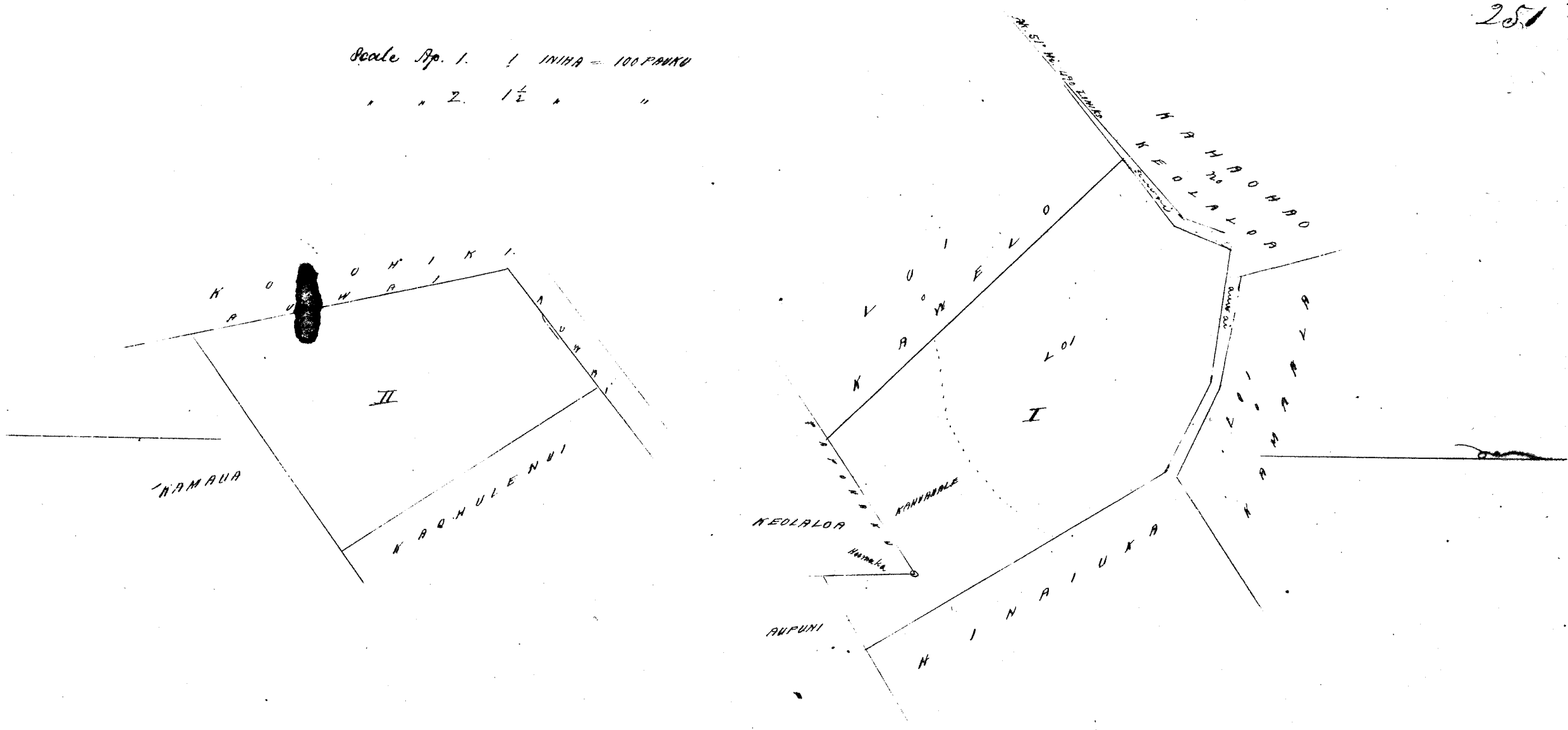

Helu 10997 Wakinikapu

Ua koi mai oia mo kona mau Apuna Aina, ma Kauluwela i Honolulu ma Kona ma ka Mo-
 kupuni o Oahu; no ka mea, ua loa ia ia keia mau wahi, no Holakua mai i ka M. 4, 1845, a ua noho keakea
 oleia a hiki i ka la 11 o Februari 1852, keakea kekahi lo'i, e ka Luma Konoheki hui e Pomanu, aka, ua hoike
 mai o Kale, aole ia lo'i no ke Konoheki mai ka wa mai o Kamehameha I, o Kaiwi hoi ka mea ia ia, kela Ili,
 aole no hoi i ka wa ia Kihelani a ia Kawailipoleps a ia Kanakaiki a ia Kalikua, no ke kamae, no kela lo'i mai
 Konoheki mai. A i ka la 13 o October 1853, hui mai o Pomanu i kona hoopau ana i ke keakea ma ua lo'i la, a i
 maila, "Aole he keakea i keia kuleana, ua ae no o W. Kekunana i kela Lo'i a i manana ai e keakea, a ua huawi aku
 nohila aole keakea i keia"

No laila, ke hoohe me, makou no Wakinikapu, he kuleana hoi kona malalo iho o ke Aro Alodio.
 Ina e uku mai oia i ke keia Apuni, kapaha, alaila ua kupa no ia ia ka Palapala Sita Alodio.

- No me ia i ke uku no ka hoohe okele a me ka hoohe okele ana i ka olelo. Puni;
- W. L. Lee No ka rumi o me he pai ana i ka olelo ma ka Mapepa.
- G. M. Robertson No ke kope ana i ka olelo koina
- J. H. Smith No ke palapala kii
- J. Kekaulahao No ka hana ana i ka la 11 o Februari 1852.
- No ke kope ana i ka olelo a na hoike 13 Awa
- No ke ana ana i ka la 28 o October, 1852.
- No ke kope ana
- No ka hoohe okele ana i ka olelo koina i ka la 13 o October 1853.

Oia ma palena. Ania e S. P. Kalama.

- Apana 1. Kauluwela, Honolulu, Oahu.
 Apuna 1. 1 Loi. E hoomaka ma ke kiki Konoheki ma ka o keia, a e holo Akau 39' 30" Kik.
 61 Panku pili ana me ke Kauhema, a e holo Kema 62' Kik. 1 23/100 Kaul. ana Kema 30' Kom. 81 Panku,
 ana Akau 53' Kom. 1 44/100 Kaul. e pili ana me ke Kauhema a hiki i ka hoi i hoomaka i 95/100 Eka
- Apuna 2. 1 Loi. E hoomaka ma ke kiki e pili ana me ke Kauhema ma ka o keia, a e holo
 Akau 30' 30" Kik. 1 1/100 Kaul. a me Akau 50' 30" Kom. 2 Kaul. ma ke Kauhema a me Konoheki a hiki
 i ke Kauhema. Alaila Kema 40' 30" Kom. 1 1/100 Kaul. a me Kema 50' Kik. 2 1/100 Kaul. ana ke Kauhema
 a me Konoheki a hiki i ka hoi i hoomaka i 215/100 Eka.
- Apuna 3. 1 Loi. E hoomaka ma ke kiki Kihuna Akau o keia Loi, e pili ana ma ka
 aina o Kalama a me ke Kauhema, a e holo Kema 29' 15" Kom. 91 Panku, ana Akau 63' 30" Kom. 1 1/100 Kaul.
 e pili ana me ke Kauhema a hiki i ka Auwai. Alaila Akau 28' Kik. 88 Panku ma ka palena auwai me

Kūkānaka a hiki ike Kalama, alaila Kōma 64° Hik. 1⁵⁵/100 Kaul. ma ko Kalama a hiki i kahi i hōmaka'i. ¹⁴/100 Eka.

Apana 4. 1 Lōi. E hōmaka ma kēkahi mauka e pili ana me ko Kalai a me Kuana o Kūkānaka, alaila Kōma 70° 30' Hik. 1²⁵/100 Kaul. ma ia Kuana a hiki i ka uina i kōia e Nika, - alaila Kōma 36° Kōm. 93 Pūku, a me Akau 58° Kōm. 1²/100 Kaul. me ko Nika, - alaila Akau 44° 30' Hik. 67 Pūku ma ko Kalai a hiki i kahi i hōmaka'i. ⁹⁶/100 Eka.

Apana 5. 1 Lōi. E hōmaka ma kapaku i anaia e James Dilona no Kaluwemamu ma ka lina Kōma o ka Hale o Laau, alaila Kōma 35 1/2° Kōm. 1⁴⁴/100 Kaul. ma kahi wahi wale no ke Kōmohiki a hiki i ke Kōmohiki, alaila Kōma 57° Hik. 1⁸⁹/100 Kaul. me Kōmohiki, a me Akau 42° Hik. 1²/100 Kaul. me ko Kaluwemamu o hiki i ke Kuana, alaila Akau 58° Kōm. 1⁸³/100 Kaul. ma ko Kuana a hiki i kahi i hōmaka'i. ²⁴/100 Eka.

Okatō 28, 1852.

J. P. Kalama
Ka mea Anā

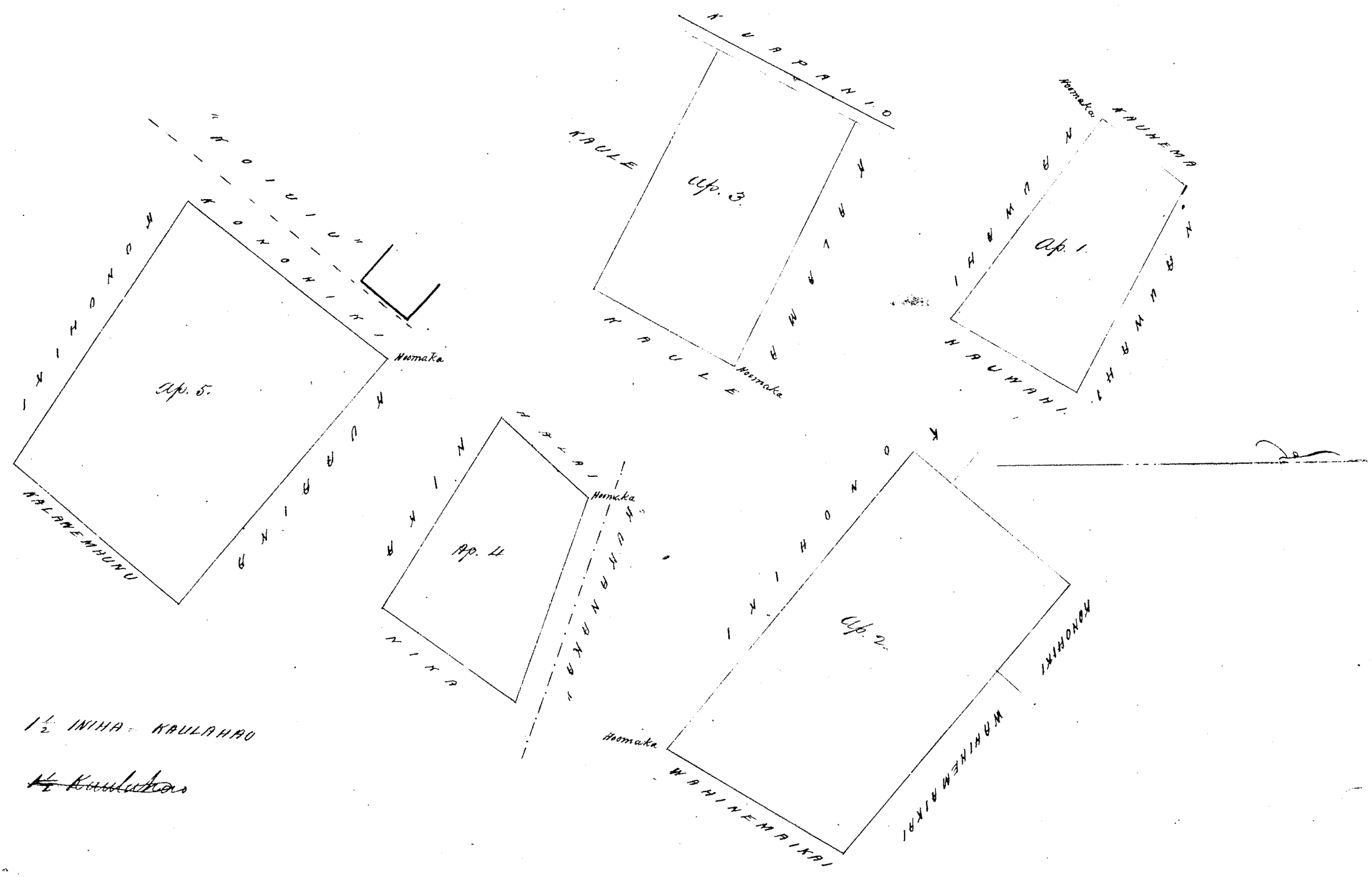

Helu 79 Napehe

Ua kōi mai oia no kōna Pakala ma ke Kūlunakauhale o Kōni-lulu, ma Kōma, ma ka Mōkōpuni Oahu, no ka mea, ua loa ia i keia wahi no Punahale mai ka mākau i keia mānau a e ka māke aia o Punahale kūmau, kaueha i keia wahi i kōna wahine a me na aia a pau, ua kōi mai ia Punahale i ke Kōma ana o Kōma i ka M. H. 1824, a me nōho no Punahale i keia wahi a hiki i kōna ua i māke ai, a ihi mai kahi i kōna wahine, a kōho no kōna wahine malaila a hiki i ka mānau mānau a e ka M. H. 1848, kōpūkaia o Napehe, a lawe ka Mōi Kōma i ka pū a hōmaka i ka Potosamu. Noia nei, ua keakea maika Mōi Kamehameha III, a ua hanaia imi o mākou, Aka, i ke mākou mānau āna, ua māi pōpō ke kuleana māi pōpō keia, ua loa ia i Punahale i ka mākau a e keia mānau i kōna mānau mānau mānau, a e ka Mōi Kamehameha III, māi keia wahi i Punahale, a o keia lawe āna o ka Mōi Kamehameha III, ua kuleana o, a ua lawe maika āna kō i ka mānau o ke Kōma Kanawai o keia Oahu, o ka M. H. 1839.

Noia nei, ke hōko nei mākou no Napehe ua pakala la e hiki me ka oia o keia mānau i keia mānau mānau, a ke kuleana mānau mānau mānau iho o ke Anō Alodis. Ema e ukū māi oia i ke ke Oahu.

hapaha; alaila, ua kupo i ia i ka Palapala Sila Alodio.
 Iono nae ia ia ke iku no ka hookolokolo a me ka hookolo ana i ka olelo. Penei,
 W. L. Lee
 G. M. Robertson
 J. H. Smith
 No ka rumi a me ke pa'i ana i ka olelo ma ka Muepea.
 No ke kope ana i ka olelo ko'ina
 No ka palapala kii
 No ka hana ana i ka la 19. August 1846. & 11. October 1848.
 No ke kope ana i ma olelo a ma ho'ike
 No ke ana ana i ka la 13. October 1853.
 No ke kope ana
 No ka hookolo ana i ka olelo i ka la 17. October 1853.

Eia ma palena. Anaia e S. P. Kalama

Pahale ma Honolulu (Mulanaka'uhale) Oahu.

E, hoomaka ma ke kiki Komo'ama o keia Pahale e pili ana i ma ka pa o John Meek a me ke kiki Akau i ka pa o Ka'aila'uhala, a e holo Koma 40' Kikina 96 Panku e pili ana me ka pa o Ka'aila'uhala no Kalawaia i keia wa a hiki i ke Ala O'oli; Alaila Akau 50' Kikina 126 Panku e pili ana me ke Ala O'oli i ho'okaawale ia e na Luma Koma a hiki i ke Alanui Hotele; Alaila Akau 41' Kom. 88 Panku e pili ana me ka lihi ma'akai o ke Alanui Hotele a hiki i ka pa o John Meek; Alaila Koma 52' Kom. 73 Panku ma'ake, me Koma 57' Kom. 29 Panku anahua a me Koma 52' 30' Kom. 23 Panku e pili ana (Koma 52' 30' Kom. 23) i ma ka pa o John Meek a hiki i ka hoomaka ana. Eia ka Ii 145 Anana

S. P. Kalama
 Ana ana

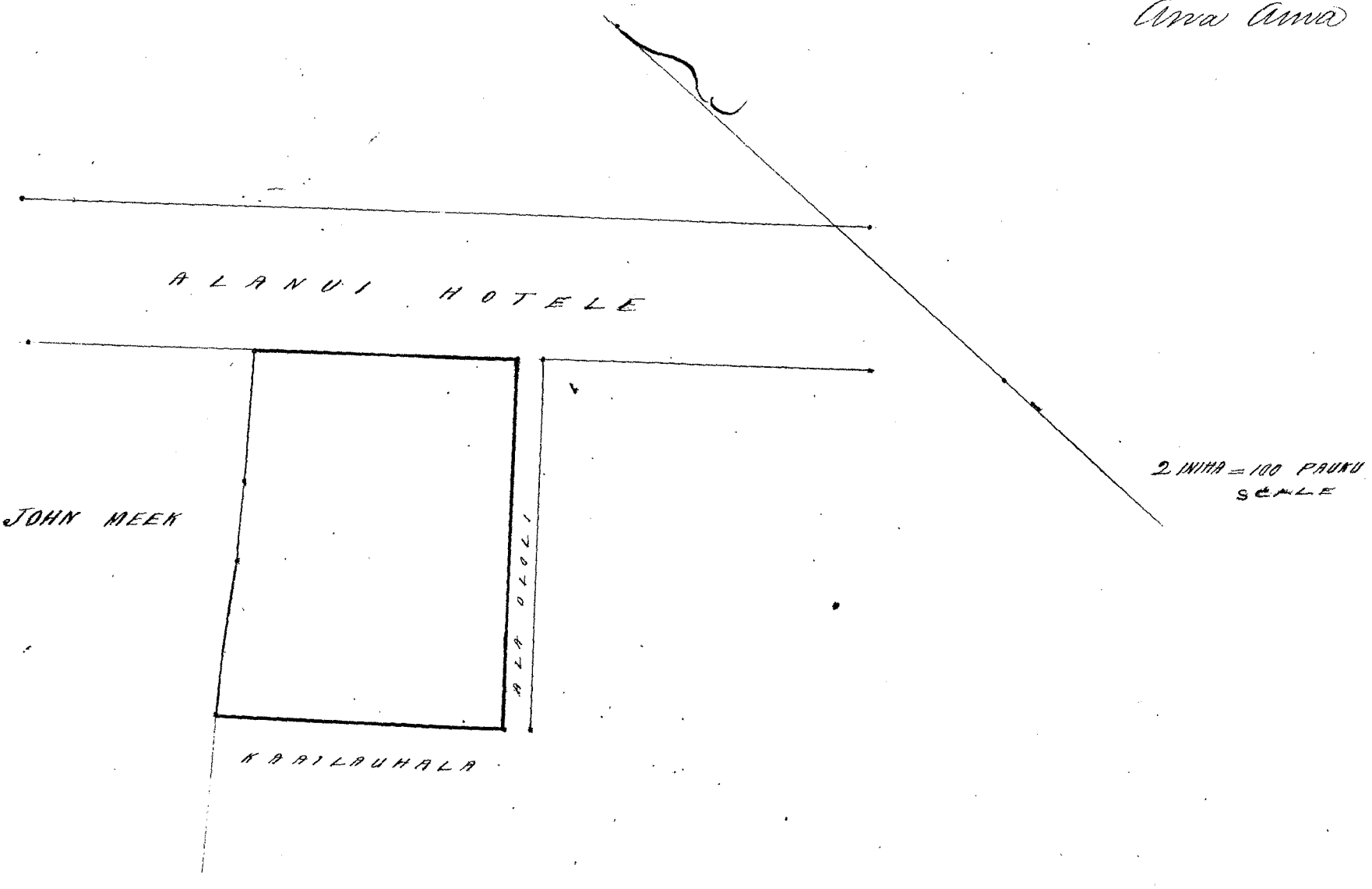

Helu 1314 Puahiki

Ua koi mai oia no kona mau Apana ana ma Puuwa i Nuuanu, Honolulu ma Koma, ma ka Motu'upuni o Oahu; no ka mea, ua loa i ia keia wahi no Koi'ama'i mai i ka wa o Kamohamoha II, a ua noho, keakea, o'ia a hiki i keia manawa.

Oia ka maku e hooko nei no Puahiki; ke kulu ana ko'ina ma'alo iho o ke Awa Alodio. Ina e uka mai oia i ke ke Aupuni hapaha; alaila, ua kupo i ia i ka Palapala Sila Alodio.

Iono nae ia ia ke iku no ka hookolokolo a me ka hookolo ana i ka olelo, Penei,
 W. L. Lee
 G. M. Robertson
 J. H. Smith
 J. Mikanalaka
 No ka rumi a me ke pa'i ana i ka olelo ma ka Muepea.
 No ke kope ana i ka olelo ko'ina
 No ka palapala kii
 No ka hana ana i ka la 15. September 1848
 No ke kope ana i ma olelo a ma ho'ike
 No ke ana ana i ka la
 No ke kope ana
 No ka hookolo ana i ka olelo i ka la 17. October 1853.

Anaia e S.P. Kalama.

Aina ma Piiwa, Muiamu, Honolulu, Oahu.

Ap. 1. Kula me Kahuakale. E hoomaka ma ke kiki (Kema o keia) Apuna aina, ma ke pohaku ihoaitonaiia x ma ke papohaku, ma ke kiki mauka o ke Ala Ololi, - A e holo Akau 41° Kom. 218 Panku ma ke kiki mauka o ke Ala Ololi a hiki i ke pohaku x o Naimu, - Alaila Akau 69° 15' Hikina 91 Panku, - Akau 48° Hikina 220 Panku e pili ana me Naimu, Koa ame Aupuni, - Alaila Kema 48° Hikina 82 Panku pili me Aupuni a hiki i ke papohaku o Kale, - Alaila Kema 80° 30' Kom. 331 Panku ma ke papohaku o Kale a hiki i ke hoomaka ana, Ka Ii 43/100 Eka.

Ap. 2. 3 Poi me Kula. E hoomaka ma ke kiki (Kema o ke aina o Luau ma ke papohaku o Manuela, no Kale, kiki Hikina o keia aina, - A e holo Akau 34° 30' Kom. 113 Panku, - Kema 51° Kom. 36 Panku, - Akau 36° Kom. 147 Panku, - Akau 64° 15' Hikina 39 Panku, - Akau 32° Kom. 134 Panku, - Kema 38° Kom. 32 Panku ame Akau 49° Kom. 38 Panku ma ke palena o Luau, - Alaila Kema 42° 15' Kom. 40 Panku ame Akau 37° 30' Kom. 9 Panku palena me Pakaona, - Alaila Kema 51° Kom. 111 Panku palena me Luau a hiki i ke palena o "Piiwa" me "Punaanana" Alaila Kema 43° Hikina 141 Panku, - Kema 45° Hikina 269 Panku ma ke palena o Piiwa me Punaanana no Kekoa. Kaiama a hiki i ke papohaku o Manuela, - Alaila Akau 53° 30' Hikina 117 Panku palena papohaku me Manuela no Kale a hiki i ke hoomaka ana, Ka Ii 57/100 Eka

Ap. 3. Kula Mahiai uuala a me Kale. E hoomaka ma ke papohaku x ma Kahawai kiki (Kema o keia aina, - A e holo Akau 45° 45' Kom. 684 Panku palena me Naimu a hiki i ke pohaku x ma ke Ala kiki pali hanahanai, - Alaila Akau 74° 45' Kom. 154 Panku me Lililehua, Alaila Akau 35° 30' Hikina 413 Panku pili me Manuela no Kale, Alaila Kema 71° 30' Hikina 140 Panku pili me Aupuni a hiki i ke pohaku x ma ke pali lele, - Alaila Kema 62° 15' Hikina 152 Panku iho ma ke pali e moku ana i ke Kahawai a hiki i ke pohaku x, - Alaila holo pololei ikai ma Kahawai a hiki i ke hoomaka ana, Ka Ii 2 20/100 Eka.

Ap. 4. 3 Poi me Kula. E hoomaka ma ke pohaku x ma ke kiki (Kema o ke aina o Manuela e pili ana me ke Kekoa ma "Punaanana", - A e holo Kema 22° Hikina 393 Panku pili me Kaiama a me Kahawai a hiki i kona uake e holo ana i ke, - Alaila Kema 77° 30' Hikina 192 Panku ma Kahawai, Alaila Akau 10° 15' Kom. 303 Panku ma ke aina o ke Aupuni, - Alaila Akau 11° 15' Hikina 170 Panku pili ma ke pali, - me Akau 50° Hikina 94 Panku pili me Koa, - Alaila Akau 39° 30' Kom. 88 Panku me Lililehua a hiki i ke pohaku x o Manuela mauka iho o ke puhala, - Alaila Kema 48° Kom. 212 Panku, - me Kema 71° Kom. 170 Panku me Manuela a hiki i ke hoomaka ana, Ka Ii 4 34/100 Eka.

Ma ka Ii a pau

Ka Ii 1 14/100 Eka

43
57
2.20
1.14
4-334

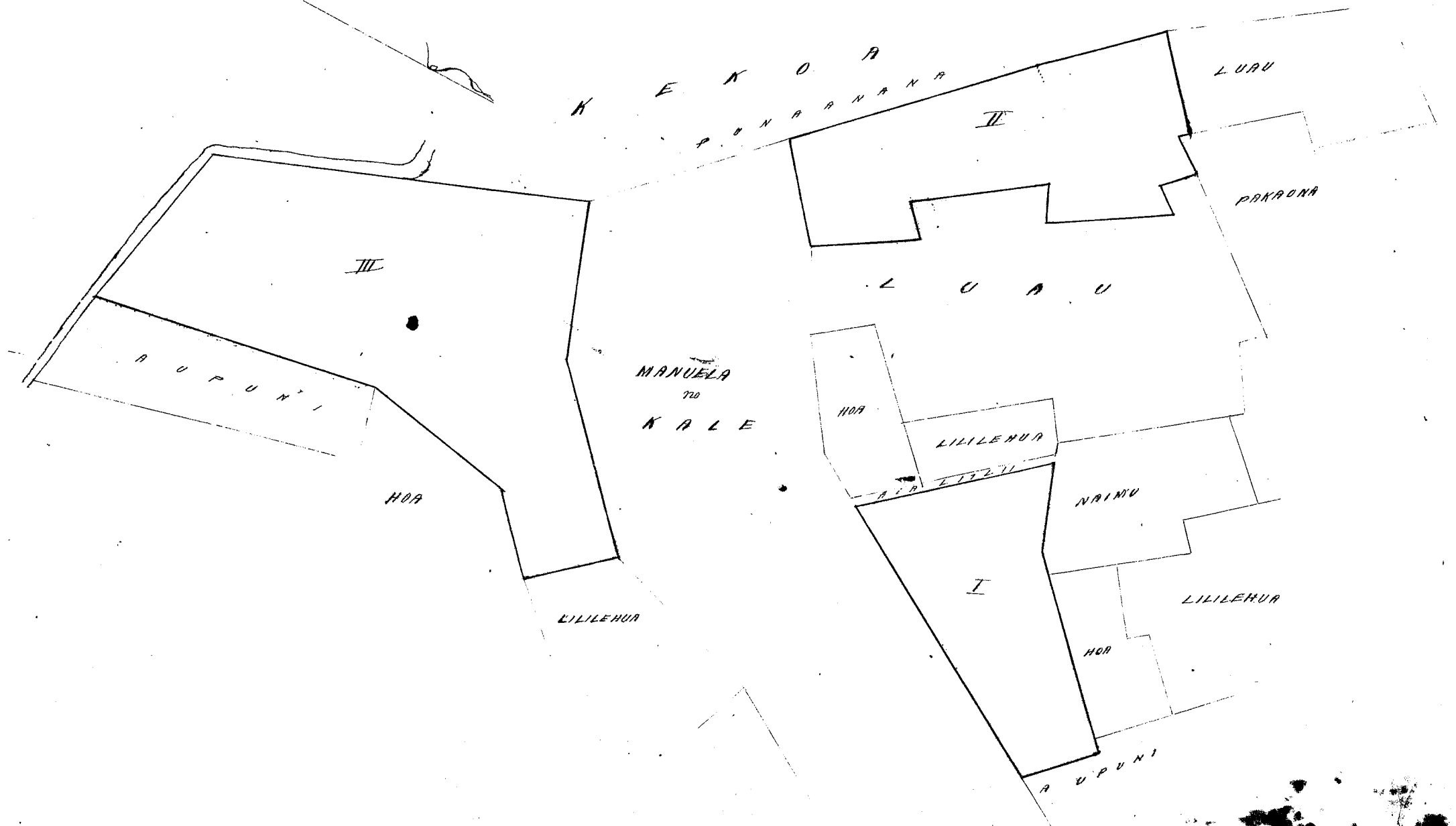

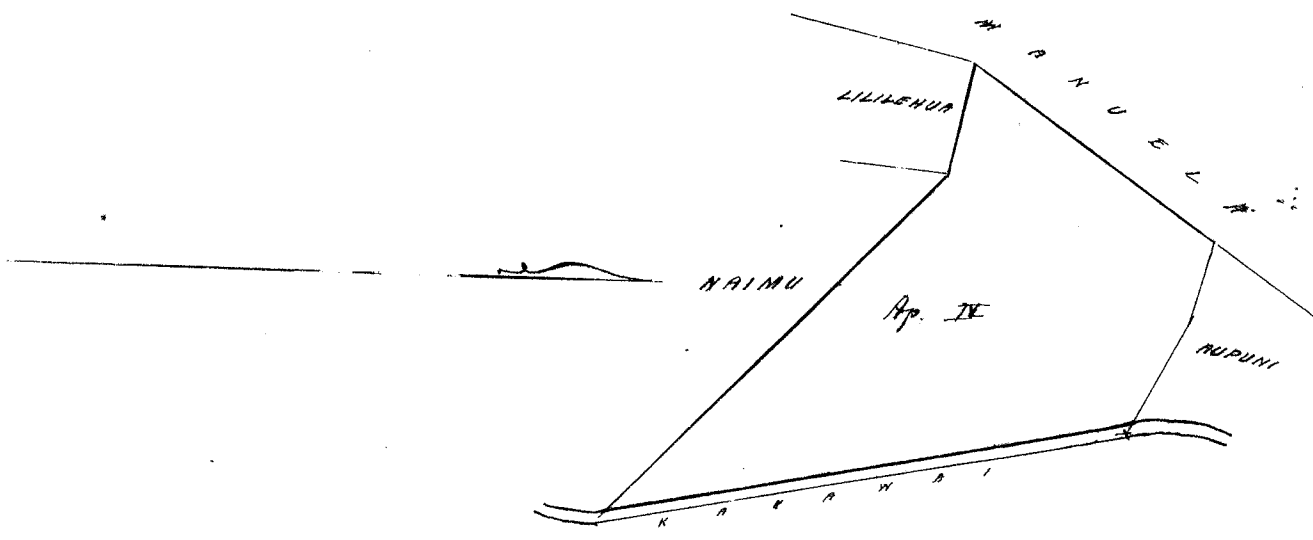

Helu 1663 Malio

Ua hoi mai oia no kona wahi Apuna aino ma Kapiwai Pauoa i Honolulu, ma Kona, ma ka Mokupuni o Oahu; no ka mea, ua loa ia ia keia wahi no Keikenui i ka manawa no e ola ana o Mo. Kekaulaohi; a ua noho keia oleia a hiki i keia manawa

Oia ka makou e hooke nei, no Malio, ke kuleana hoi keia malalo iho o ke Ano Alodi. Ina e uku mai oia i ke ke Aupuni hapaha; alaila uakupono ia ia ka Palapala Sila Alodi.

Pono mai ia ia ke uku no ka hooke loholo a meka hooke ana i ka olelo. I nei

- | | |
|-----------------|--|
| W. L. Lee | No ka rumia a me ke pua ana i ka olelo ma ka Nupapa. |
| G. W. Robertson | No ke kope ana i ka olelo keia |
| J. H. Smith | No ka hana ana i ka lawa 12 o October 1849. |
| J. Kekaulaohi | No ke kope ana i ma olelo a ma hooke 13 oia |
| | No ke ana ana i ka lawa 24 o August 1853. |
| | No ke kope ana |
| | No ka hooke ana i ka olelo keia i ka lawa 27 o October 1853. |

Eia ma palena. Anaiw e S. P. Kalamo

6

Ma Kapiwai, Pauoa, Honolulu, Oahu.

9 Loi. E hoomaka ma ke kahi Kama o keia aino e pili ana me ka Loi Koele ma Kahawai, a e holo Akaw 57° 30' Kom. 118 Puku, - a me Kama 45° Kom. 46 Puku e pili ana me na wahi Loi Aupuni a hiki i ke Ohule, - Alaila Akaw 38° 30' Kom. 94 Puku, - a me Akaw 7° Kom. 150 Puku e pili ana me Ohule a me ke koele Aupuni a hiki i ka papohaku o J. Booth, - Alaila Akaw 88° Kikina 115 Puku, hiki i papohaku paa mawaho o ka paa ke 10 Puku ke ake, - a me Akaw 46° Kikina 138 Puku e pili ana me J. Booth, - Alaila Kikina 60 Puku ma ka aao mauka o keia a hiki i Kahawai, - Alaila iho ikai ma Kahawai a hiki i ka hoomaka ana

Eia ka Ili 65/100 Eka.

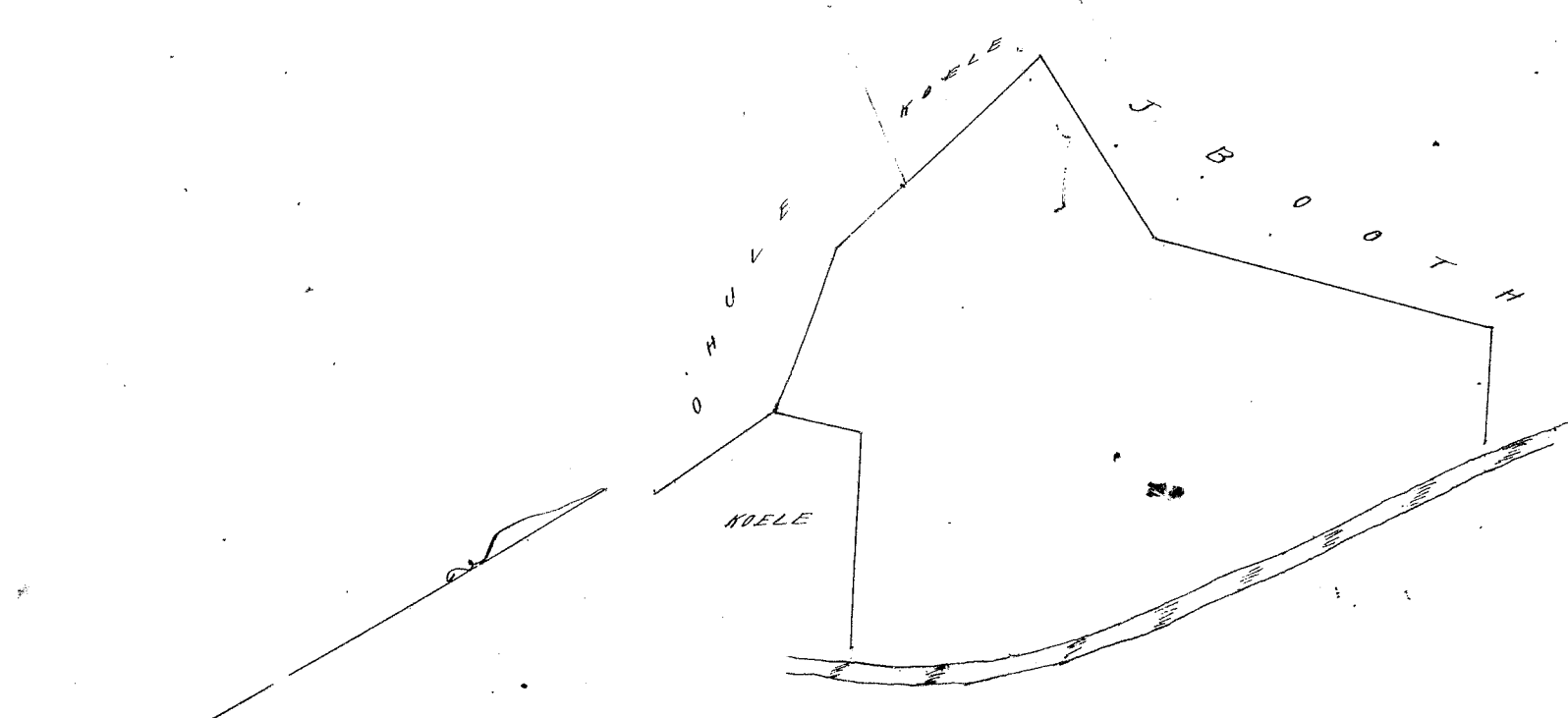

INIA 100 PUKU SCALE

Helu 1557 Kooea (no Palakiko w)

Ua hoi mai oia no kona wahi Apapa aina ma Kapiwai Paua i Honolulu, ma Kona, ma ka Mokupuni o Oahu; no ka mea, ua loa ia ia keia wahi no Kameakalau i ka wa e ola ana o Kinaw i ka M.H. 1835, a ua noho keakea oleia a hiki i keia manawa.

Oia ka makou e hoohe nei no Kooea; he kuleana hoi kona malalo iho o ke Ano Alodio. Ina e uku mai oia i ke kee Aupuni hapaha; alaila, ua kupo ia ia ka palapala Sita Alodio.

~~Ina e uku mai oia i~~
W. L. Lee
G. M. Robertson
J. H. Smith
S. Kekaulaha

Pono nae ia ia ke uku no ka hoohele a me ka hoohele ana i ka olelo, Penei:
No ka rumi a me ke pui ana i ka olelo ma ka Nupepa.
No ka kope ana i ka olelo koina
No ka palapala kii
No ka hana ana i ka la 29 o Januari 1853.
No ka kope ana i na olelo a ma hoike 1/3 Awa.
No ka ana ana i ka la 24 o Augate 1853.
No ke kope ana
No ke hoohele ana i ka olelo i ka la 27 o October 1853.

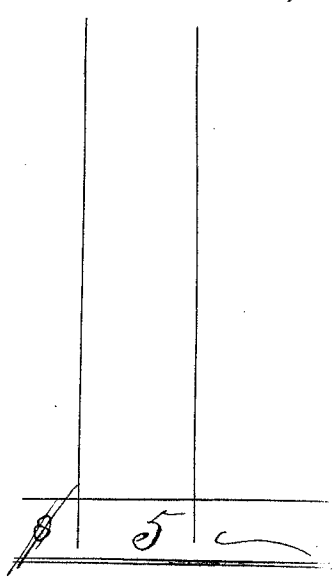

Eia ma palena. Anai e S. P. Kalama.

Ma Kapiwai, Paua, Honolulu, Oahu.

4 Poi: E hoomaka ma ke kahi Komohana Kema o keia aina ma Kahawai, Aieholo Kema 26° Hikinoo 103 Pooku e pili ana me ke Kaele i koina e Keohokalole, - Alaila Akaw 51° 30' Hikinoo 166 Pooku malalo o ke Kula pali i koina e Keohokalole a hiki i ke kahi Komohana o ke Kaele olelo e pili ana ma ka pali, - Alaila Akaw 38° Hikinoo 107 Pooku ma kuumaka me ke Kaele olelo, - a me Akaw 55° Kom. 153 Pooku e pili ana me ke Kaele ma ka i koina e Keohokalole a hiki i ke kahi Komohana Kema ma Kahawai; Alaila Kema 84° Kom. 32 Pooku ma ka wela o Kahawai a hiki i ka wai e kake ana, - Alaila Kema 7° Hikinoo 117 Pooku, - a me Kema 36° 30' Kom. 68 Pooku, - a me Kema 82° 30' Kom. 56 Pooku ma Kahawai a hiki i ka hoomaka ana.

Eia ka Ili 28/100 Eka.

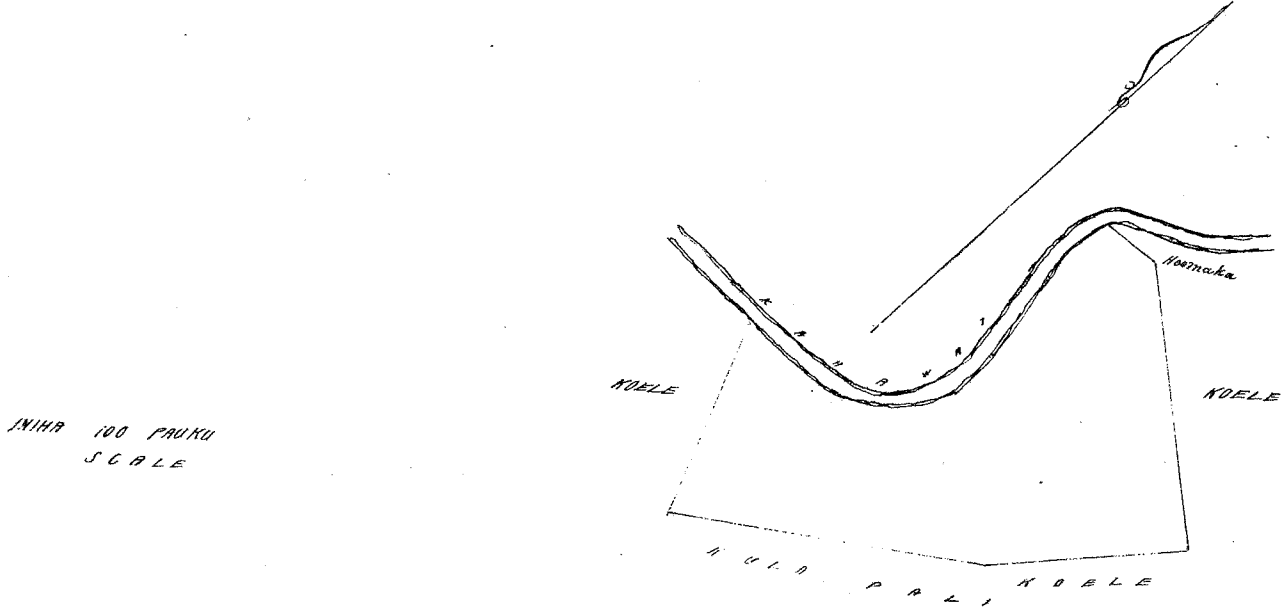

Helu 1564 Keawe

Ua hoi mai oia no kona wahi Apapa aina ma Kapiwai Paua i Honolulu, ma Kona, ma ka Mokupuni o Oahu; no ka mea, ua loa ia ia keia wahi no Kameakalau mai i ka wa e ola ana o Kinaw, a ua noho keakea oleia a hiki i keia manawa.

Oia ka makou e hoohe nei no Keawe; he kuleana hoi kona malalo iho o ke Ano Alodio. Ina e uku mai oia i ke kee Aupuni hapaha; alaila, ua kupo ia ia ka Palapala Sita Alodio.

Pono nae ia ia ke uku no ka hoohele a me ka hoohele ana i ka olelo, Penei:
W. L. Lee
G. M. Robertson
J. H. Smith
S. Kekaulaha

No ka rumi a me ke pui ana i ka olelo ma ka Nupepa.
No ke kope ana i ka olelo koina
No ka palapala kii
No ka hana ana i ka la 26 o Januari 1853.
No ke kope ana i na olelo a ma hoike 1/3 Awa
No ke ana ana i ka la 15 o Augate 1853.

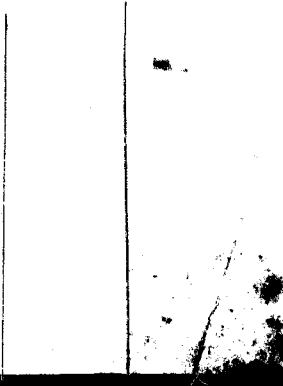

No ke kope ana
 No ka hoohele ana i ka olelo koina i ka la 27 o October 1853.

25
 10

Eia na palena. Anaiia e S. P. Kalama.

Aina ma Kapiwai, Honolulu, Oahu.

Aina kato me kula ana kahuahele. E hoomaka ma ka laau i, i anaiia e A. G. Thurston ma ke kumupali e pili ana me ka palena no Waiwaiole. - A e holo Kema 3° 15' Kikina 286 Pauku iho a hiki i ka pohaku x, - a me Kema 35° Kikina 293 Pauku iho e moku ana ke kahawai, pili ana me Waiwaiole a hiki i ka palena o Kalawahine ma ka pohaku ihoailonaia x ma ke Alanui, - Alaila Kema 56° Kom. 174 Pauku, - a me Kema 32° 30' Kom. 187 Pauku, - a me Kema 37° Kom. 124 Pauku, - a me Kema 32° Kom. 117 Pauku ma ka palena o Kalawahine a hiki i ka pohaku x, ke kiki Kema makai o keia aina, - Alaila Akau 41° 45' Kom. 2 1/2 Kaulahad iho ilalo e moku ana i ke kahawai, e pili ana me ka aina o Kahinu a me ke Mookaaw a hiki i ka pohaku x, - Alaila Akau 18° 30' Kom. 5 Kaulahas e pili ana me ke Mookaaw a hiki i ka pali lai malalo, - Alaila Akau 59° Kikina 612 Pauku e pili ana me ka pali o ke Aupuni a hiki i ka hoomaka ana.

Eia ka Ili 3 56/100 Eka.

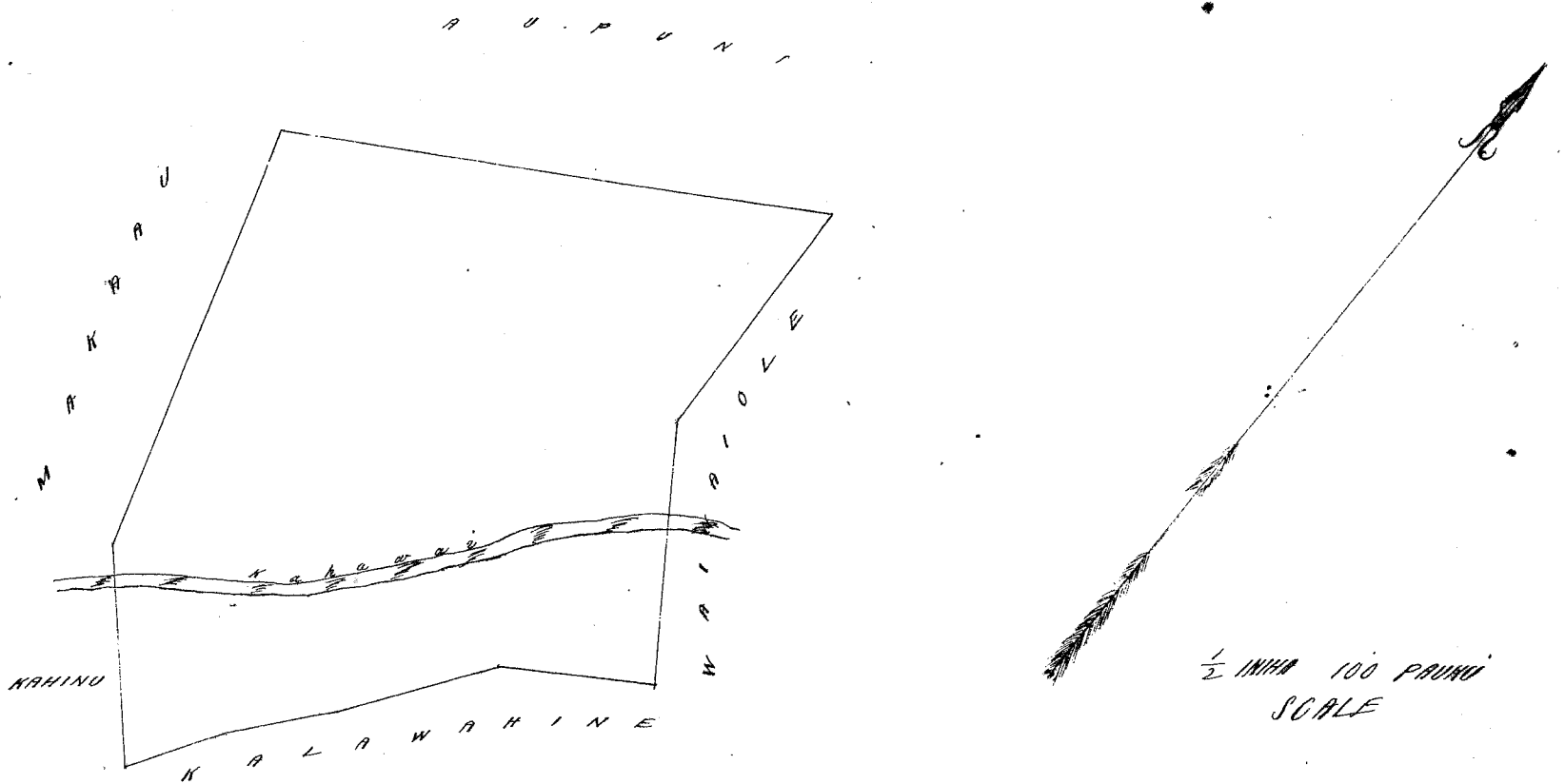

Heleu 1875 Kekuahele

Ma kei mai oia no kona wahie ma Kapiwai, Paua i Honolulu, ma Kona, ma ke Mookupuni o Oahu; no ka mea, ua loaa ia ia keia wahie no Kekuahele mai i ka M. B. 1839, a ua noho keakea oleia a hiki i keia manawa. Eia ka mahoe e hoohele nei no Kekuahele; he kula ana hoi koina malalo iho o ke Ano Alodis. Eia e uku mai oia i ke ke Aupuni hapaha; alaila, wai kupono ia ia ka Palapala Sita Alodis.

Pono nae ia ia ke uku no ka hoohele ana i ka olelo, Penei, -

- W. L. Lee
- G. M. Robertson
- J. H. Smith
- J. Kekuahele

- No ka oumi a me ke pili ana i ka olelo ma ke Mookupuni
- No ke kope ana i ka olelo koina
- No ka palapala kei
- No ka hana ana i ka la 29 o Januari 1849.
- No ke kope ana i ka olelo a na hoi ke 1/3 Ana.
- No ke ana ana i ka la 24 o Aigate 1853.
- No ke kope ana
- No ka hoohele ana i ka olelo i ka la 27 o October 1853.

6

Eia na palena. Anaiia e S. P. Kalama.

Ma Kapiwai, Pauoa, Honolulu, Oahu.

2^o Loi. E hoomaka ma ka papohaku nui ma Kahawai ma ka lilihi Komohana o ke Kahawai, Aeholo Akau 58°30' Kom. 130 Pounu pili me Kihilani, - Alaila iho ika'i 534 Pounu ma ka papohaku o J. Booth, - Alaila Komu 47° Hikina 50 Pounu aaoa makai o keia aina a i Kahawai, - Alaila ma Kahawai me Kahowaha, Kaauhau a hiki i ka hoomaka ana

Eia ka Ili

48/100 Eka

S. P. Kalamo
Ananina

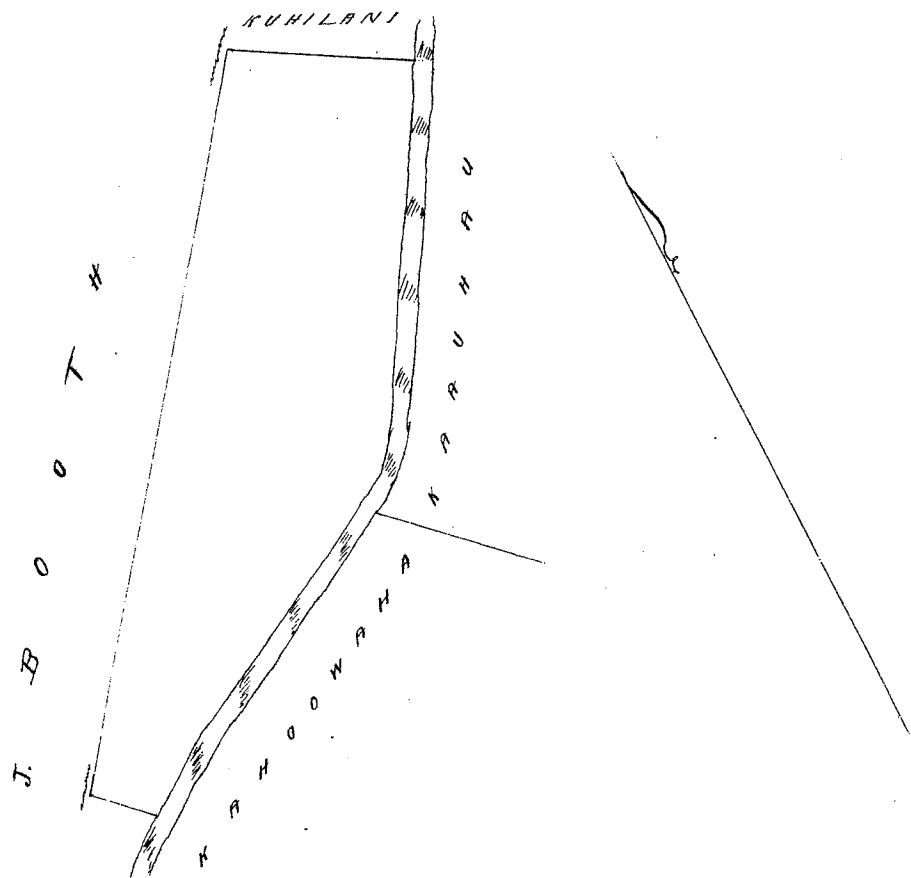

3/4 INIHA 100 POUNU

Helu 1673 Malulu

Ua koi mai oia no kona wahi opana aina ma Kaakopua Honolulu, ma Kona, ma ka Mokupuni o Oahu; no ka mea, ua loa ia ia keia wahi no Publica mai ke Konohiki ika'ua e olu'olua o Kalaimoku, a ua noho keakea oleia a hiki i keia mamawa.

Oia ka makou e hoohe'uei no Malulu; he kuleana hoikona malalo iho o ke Ano Aloha. Ina e ukua mai oia i ke ke aupuni hapaha; alaila, waikepono iua ka Palapala Sela Aloha.

Pono mai ia ia ke ukua ma ka ~~hoohe'uei~~ hoohe'uei a me ka hoohe'uei ana i ka olelo, Penei,

- W. L. Lee
- G. M. Robertson
- C. H. Smith
- S. Kekaulahao

- No ka oumi a me kepa'i ana i ka olelo ma ka Nupupu
- No ke kope ana i ka olelo ko'ina
- No ka palapala kii
- No ka hana ana i ka la 15 o October 1849.
- No ke kope ana i na olelo a ma hoike 1/2 aaoa
- No ke ana ana i ka la 24 o October 1853.
- No ke kope ana
- No ka hoohe'uei ana i ka olelo i ka la 29 o October 1853.

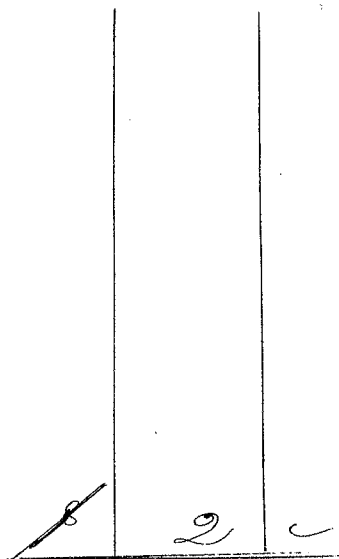

Eia kona pulina. Anai a S. P. Kalamo.

Aina ma Kaakopua, Honolulu, Kona, Oahu.

3^o Loi me Kula ame Hale. E hoomaka ma ka kiki Komu o keia aina, e pili ana me ka pa-aina a me ke Komo, - Aeholo ana Akau 71°45' Hikina 94 Pounu e pili ana me ka pa-aina a hiki i ka aina no Limaikeika, - Alaila Akau 38° Kom. 6 Kaulahao me 73 Pounu e pili ana me ke Limaikeika a hiki i ke kiki Akau o keia aina, - Alaila Komu 48°30' Kom. 94 Pounu e pili ana me ka aina o Konaialea a hiki i ka auwai liliu, - Alaila Komu 38°45' Hikina 6 Kaulahao 35 Pounu e pili ana me Luau, Matalawelawe ame Komo a hiki i ka hoomaka ana.

Eia ka Ili

62/100 Eka.

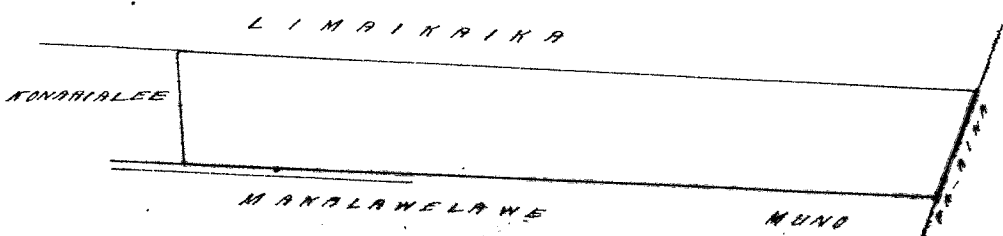

SCALE 3/8 INIHA 100 POUNU

Ua hoi mai oia no kona wahi Ahana aino ma Kapiwai, Paua, i Honolulu, ma Kona, ma ka Moku o Oahu, no ka mea, ua loa iaia keia wahi no Hanakalau mai ke Konoiki i ka wai oia ana o Hinai, a ua noho keia oia a hiki i keia manawa.

Oia ka makou i hoko nei no Makaanu, ke kulanu hoi kona malalo iho o ke Ano Aloha. Ina e uku mai oia i ke ke aupuni huihala, alaila, ua kupaia iaia ka Palapala Lila Aloha.

Pono nae iaia ke uku no ka hoooholo a me ka hoooholo ana i ka olelo, Penei,

W. L. Lee
J. Kaulahao
G. M. Robertson

No ka rumi a me ke pui ana i ka olelo ma ka Kupepa
No ke kope ana i ka olelo koia
No ka palapala hui
No ka hana ana i ka la 15 o October 1853.
No ke kope ana i ka olelo a ma hoi
No ke ana ana i ka la 15 o August 1853.
No ke kope ana
No ka hoooholo ana i ka olelo i ka la 29 o October 1853.

	12

Eia na palena. Ina e S. P. Kalamua

Aina ma Kapiwai, Paua, Honolulu, Oahu.

Aina Kalo me kula ame Kahuahale. E hoomaka ma ke kiki Konoikana o ka aina o Keawe ma ke kumu malalo o ka pali, - a e holo Kema 18° 30' Hikiina 5 Kaulahao a hiki i ka pohaku i hoailonaia x, - a me Kema 41° 45' Hikiina 50 Pauku e pili ana me ke Keawe a hiki i Kahawai e pili ana me ka aina o Kahinu, - Alaila Kema 42° 30' Kom. 176 Pauku, - ame Kema 87° 15' Kom. 141 Pauku, - a me Akau 72° 45' Kom. 117 Pauku, - ame Kema 8° 30' Kom. 129 Pauku e moku ana ke Kahawai, - ame Kema 39° Hikiina 40 Pauku ma Kahawai, - ame Kema 23° 45' Kom. 43 Pauku, - ame Kema 5° 30' Hikiina 108 Pauku, - ame Kema 38° 15' Kom. 130 Pauku a hiki i ka auwai, - Malaila aku ma ka auwai Kema 17° Kom. 144 Pauku, - ame Kema 6° 45' Kom. 87 Pauku, - Alaila Kema 62° 45' Kom. 85 Pauku hiki i ka pohaku x e pili ana ia mau aia me ke Kahinu, - Alaila Akau 38° 30' Kom. 149 Pauku ame Akau 22° 15' Kom. 330 Pauku ma ke Keleho a me ka Loi Palena e moku ana Kahawai, - Alaila 146 Pauku ikai ma Kahawai a hiki i ka pohaku x, - Alaila Akau 34° Kom. 3 1/2 Kaulahao pui ana me Keleho a hiki i ka pali lai olalo, - Alaila Akau 60° Hikiina 11 4/100 Kaulahao e hooakaawale ana i ka pali aupuni a hiki i ka hoomaka ana. Eia ka Ali 6 1/100 Eka.

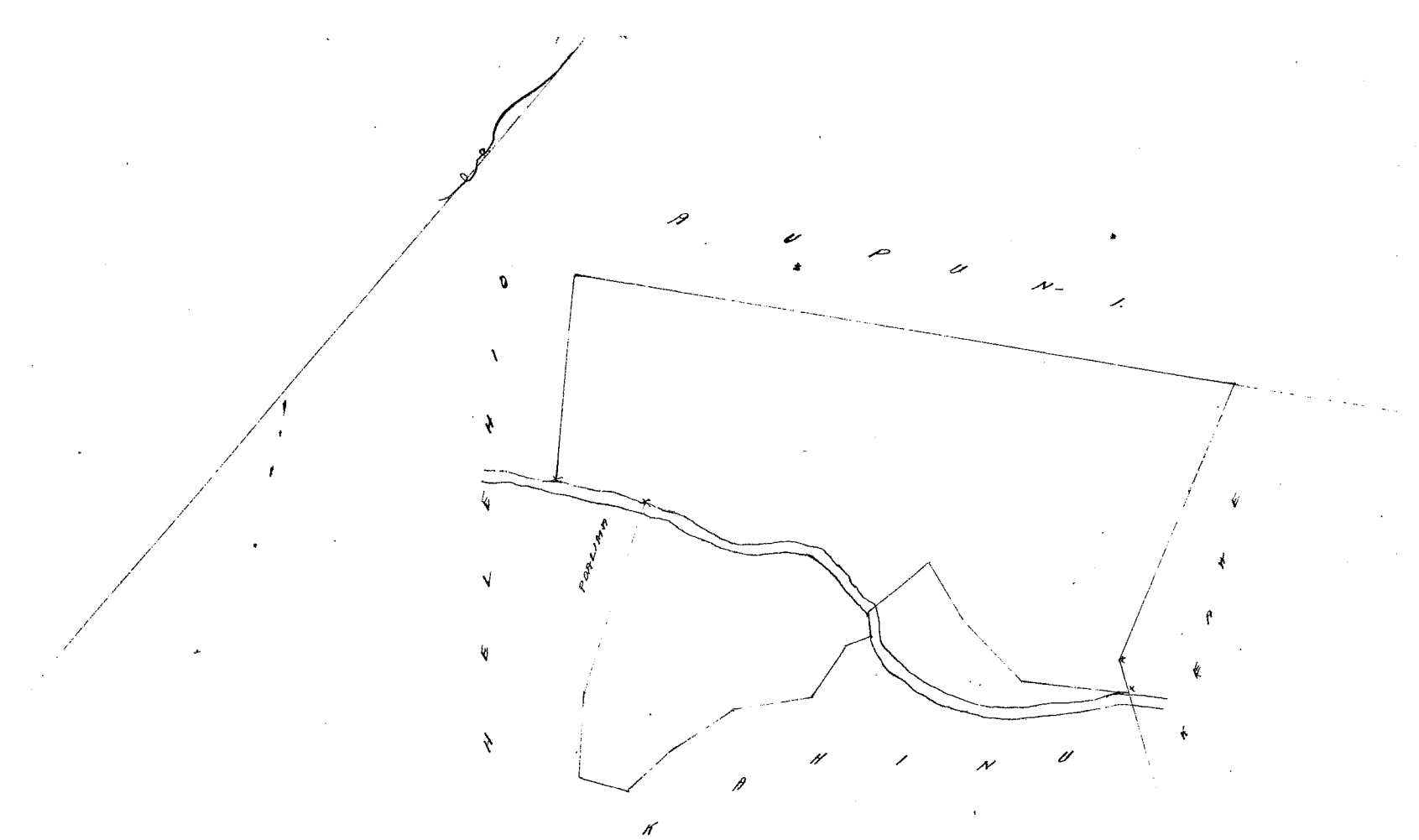

3/8 INCH 100 PAUKU SCALE

Helu 1599 Kūhīlani

Ua kōi mai oia no kona wahi āpana aina ma Kapuwai, Paua, Honolulu, ma Kona, ma ka Mokupuni o Oahu; no ka mea, ua loa ia ia keia wahi no Keikemū mai ke Honolulu ika M. H. 1844, a ua noho keakea oleia a hiki i keia manawa.

Oia ka mahou i hoohe nei no Kūhīlani; he kuleana hoi kona ma ke Ano Alodis. Ina e uku mai oia i ke ke Aupuni hapaha; alaila, ua kupono ia ia ka Palapala Sita Alodis.

Pono nāe ia ia ke uku no ka hoohehoohe a me ka hoohe ana i ka olelo, Penei:

- W. L. Lee No ka rumi a me ke pui ana i ka olelo ma ka Nupepa
- G. M. Robertson No ke kope ana i ka olelo koima
- J. H. Smith No ka palapala kii
- J. M. Kaula No ka hana ana i ka la 5 o Feberuari 1849
- J. M. Kaula No ke kope ana i na olelo a ma hoi ke 1/2 aoa
- J. M. Kaula No ke ana ana i ka la 24 o Augate 1853
- J. M. Kaula No ke kope ana
- J. M. Kaula No ka hoohe ana i ka olelo i ka la 29 o October 1853.

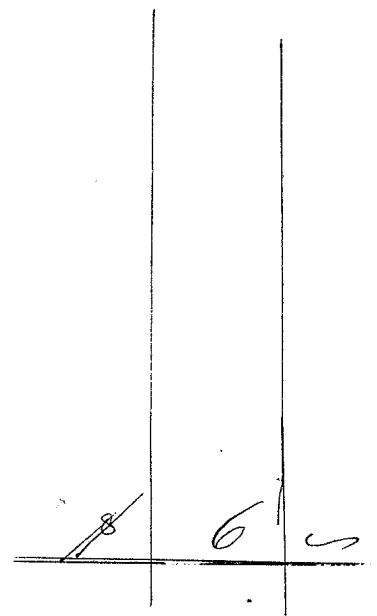

Eia na palena. Inaia e S. P. Kalamā.

Ma Kapuwai, Paua, Honolulu, Oahu.

I Lōi. E hoomaka ma ke kahi Kikina mauka o keia aina ma Kahawai, a e mee i 30 Paku ma ka Lima Komokana o ke Kahawai a hiki i kumu pali, - Malaila pii kupono iluna a hiki i ka pohaku ma ka lihi pali lili, - Alaila Kona 2° Kom. 76 Paku e pili ana ia mau awao me ka aina o Ohule a hiki i ka papohaku o J. Booth. Alaila Kona 30° Kom. 74 Paku e pili ana me J. Booth. Alaila Kona 58° 30' Kikina 130 Paku e pili ana me Kekuahauli a hiki i ka pohaku ma ka lihi Aka o Kahawai. Alaila holo pololei i keia mau Kahawai a hiki i kahi i hoomaka i. Eia ka Iki 100 Eka.

J. B O O T H
"KENOLO"

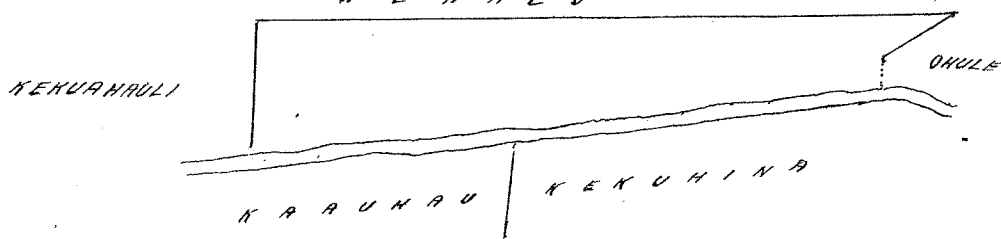

1/2 INCH TO 100 FEET SCALE

Helu 1061 Kūwāiōle

Ua kōi mai oia no kona wahi āpana aina ma Kapuwai, Paua, i Honolulu, ma Kona, ma ka Mokupuni o Oahu; no ka mea, ua loa ia ia keia wahi no Kaniakalau mai i ka wa e ola ana o Kinanā, a ua noho keakea oleia a hiki i keia manawa.

Oia ka mahou e hoohe nei no Kūwāiōle; he kuleana hoi kona ma ke Ano Alodis. Ina e uku mai oia i ke ke Aupuni hapaha; alaila, ua kupono ia ia ka Palapala Sita Alodis.

Pono nāe ia ia ke uku no ka hoohehoohe a me ka hoohe ana i ka olelo, Penei:

- W. L. Lee No ka rumi a me ke pui ana i ka olelo ma ka Nupepa
- G. M. Robertson No ke kope ana i ka olelo koima
- J. H. Smith No ka palapala kii
- J. M. Kaula No ka hana ana i ka la 12 o October 1849
- J. M. Kaula No ke kope ana i na olelo a ma hoi ke 1/2 aoa
- J. M. Kaula No ke ana ana i ka la 15 o Augate 1853
- J. M. Kaula No ke kope ana
- J. M. Kaula No ka hoohe ana i ka olelo i ka la 29 o October 1853.

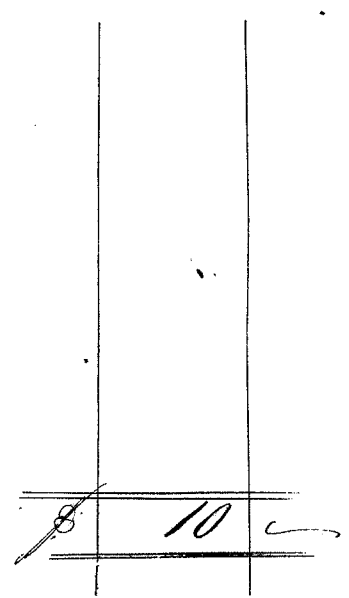

Eia na palena. Inaia e S. P. Kalamā

Ainu ma Kapiwai Paua, Honolulu, Oahu.

Ainu Kalo me Kula ame Kahuahale. E hoomaka ma ka laau i o A.G. Thurston ma ke kumu pali e pili ana me ke hiki Hikina o Keawe ame ka palena o ke Aupuni, a e holo ilalo Kema 8° 15' Hikina 286 Pautu hiki pohaku x, - ame Kema 25° Hikina 293 Pautu e pili ana me ke Keawe e moku ana i ke Kahuahale a hiki i ka pohaku x ma ke Alanui, e pili ana me "Kahuahale," Alaila Akau 46° 30' Hikina 187 Pautu, - ame Akau 33° Hikina 363 Pautu, a me Akau 19° 30' Kom. 43 Pautu, - ame Akau 23° Hikina 115 Pautu, - ame Akau 44° 45' Hikina 1 1/2 Kaulahao, - ame Akau 46° 30' Hikina 123 Pautu e pili ana me ka palena o "Kahuahale" no M. Kekauonohi a hiki i ke Manini, Alaila Akau 54° Kom. 129 Pautu iho e moku ana i ke Kahuahale a hiki i ka pohaku x ma ke laau kapa, - a me Akau 17° 30' Kom. 344 Pautu e pili ana me ke ainu o Manini ia mau ana a hiki i ka pali malama aku o ke lalo ana o ka pali, - Alaila Kema 43° 15' Kom. 890 Pautu e oki ana i ka pali me ke lalo ana o fili me Aupuni a hiki i ka hoomaka ana.

Eia ka Ali 3 90/100 Eka.

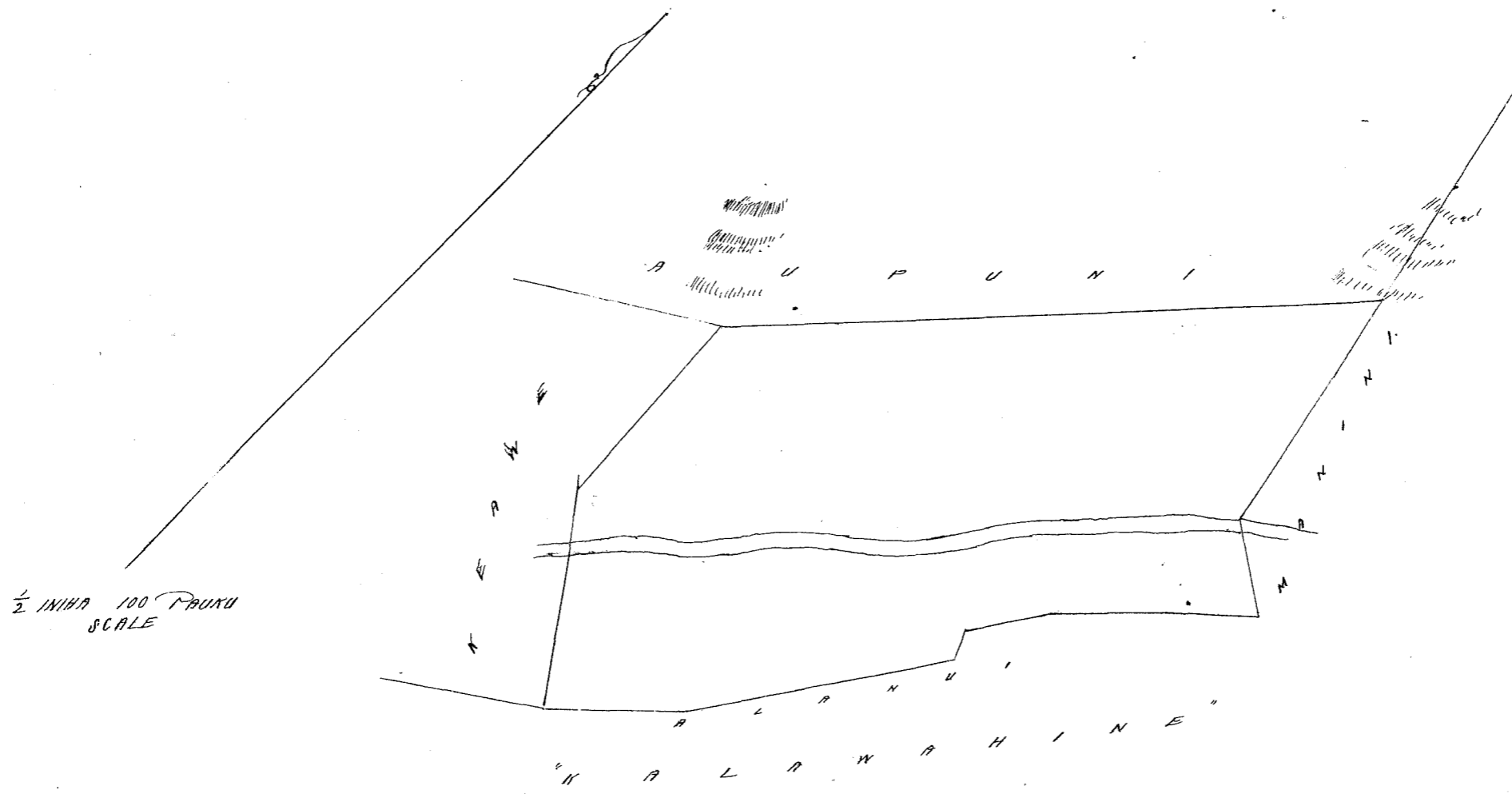

Helu 11174 Kealiko.

Ua hoi mai oia me kona wahi apana ma Waialeale ma Niihau, ma ke Pookipuni o Kauai, mo ka mea, ua loa ia ia keia wahi no Maalo mai ka lani o Alomaha, i ka M. 1834, a ua hoi mai ia i keia maua. Oia ka makou e hoohe me no Kealiko; he kuleana hoi kona malalo iho o ke Aro Aloha. Ima i uku ma oia i ke ke Aupuni hapaha; alaila, ua hoohe ia i ke Palapala Sila Aloha.

- Pono ma ia ia ke uku me ke hoohe kolo a me ke hoohe ana i ke olelo; Puni, -
- W. L. Lee No ka rumi a me ke pili ana i ke olelo ma ke Niihau
- G. M. Robertson No ke kope ana i ke olelo hoiwa
- J. H. Smith No ka palapala kii
- J. Kekaulaha No ka hana ana i ke la
- No ke kope ana i ke olelo a ma hoiwa 1/2
- No ke amana
- No ke kope ana
- No ke hoohe ana i ke olelo i keia la 1 o Novemaba 1853.

An Eia ma palena. Ania e H. M. Lyman

E hoomaka keia ma ke hiki Kema o keia e pili ana me ke Alanui Aupuni a me ke kule ana o Barenaba a e holo ma ia kule ana Ak. 2° Kom. 4, 24 kaul; alaila e holo Kema 87° Kom. 5, 03 kaul. a hiki i ke Alanui; Alaila e holo ma ke Alanui Kom. 52 1/4 Ak. 6, 58 kaul. a hiki ma ka hiki e hoomaka i. Maloko o keia 1 Eka.



Helu 1173 Nahinealua

Ua hoi mai oia no kona wahi Apaua mai Waiakea, Kila, maika Mokupuni o Hawaii; no ka mea, ua loa ia ia keia wahi manawa ake o ka manawa i noho luma ana o Maalo no Waiakea, a ua noho keakea ole ia a hiki i keia manawa.

Oia ka mukou e hooke nei no Nahinealua; he kuleana hoi kona matato iho o ke Ano Alodio. Ina e uku mai oia i ke ke Aupuni hupaha; alaila, ua kupo ia ia ka Palapala Sita Alodio.

He mau ia ia ke uku no ka hookelele a me ka hookelele ana i ka olelo, Peni:

- W. L. Lee No ka oumi a me ke pui ana i ka olelo maika Nupapa,
- G. M. Robertson No ke kope ana i ka olelo koina
- J. H. Smith No ka palapala hii
- J. Kekaulaha No ka hana ana
- No ke kope ana i na olelo a ma hoike 1000
- No ke ana ana
- No ke kope ana
- No ka hookelele ana i ka olelo i ka la 1 o Novemaba 1853.

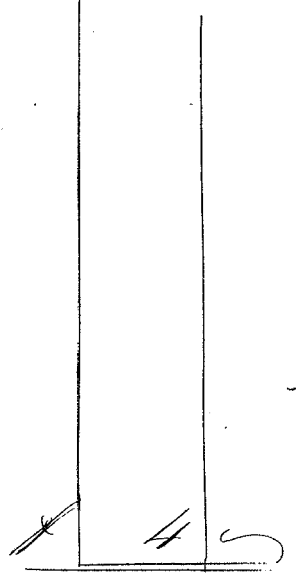

Eia na palena. Anaiia e H. M. Lyman

E hoomaka keia ma ke kumu ulu ua hoaitoiaia WM. me ke kiki maika o ke kuleana o Womona, a e holo Wom. 35 1/2 Kom. 5.04 kaul. i ke Alani Aupuni; alaila e holo ma ke Alani Wom 56 Kik. 4.25 kaul. alaila, M. 55 Kik. 5.06 kaul; alaila e holo Alani 52 3/4 Kom. 5.96 kaul. a hiki ma ke keia i hoomaka i.

Maalo o keia 2 1/2 Eka

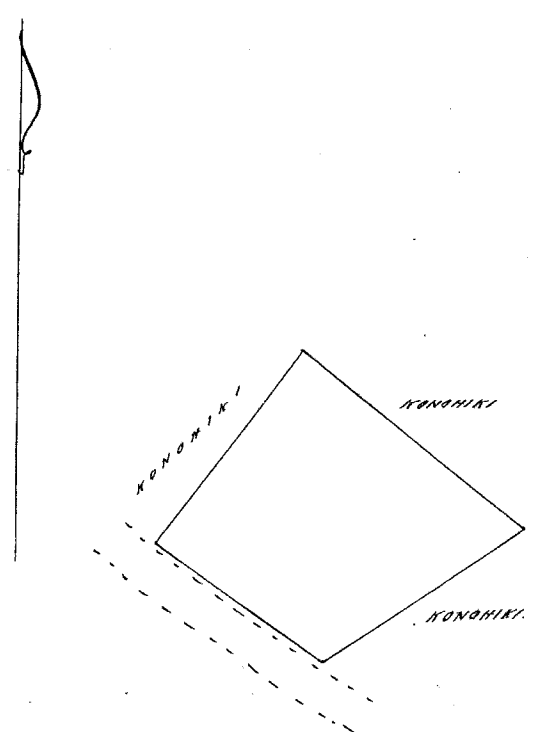

4. Chains to an Inch.

Helu 1279 L.H. Kalai

Ua hoi mai oia no kona wahi ma Kola i Waiakea, ma Kila, ma ka Mokupuni o Hawaii; no ka mea, ua loa ia ia keia wahi no Kapuaakuni mai i ka M.H. 1847, a ua noho keakea ole ia a hiki i keia manawa.

Oia ka makou e hooke nei no L.H. Kalai; he kuleana hoi kona matato iho o ke Ano Alodio. Ina e uku mai oia i ke ke Aupuni hupaha; alaila, ua kupo ia ia ka Palapala Sita Alodio.

He mau na ia ia ke uku no ka hookelele a me ka hookelele ana i ka olelo, Peni:

- W. L. Lee No ka oumi a me ke pui ana i ka olelo maika Nupapa,
- G. M. Robertson No ke kope ana i ka olelo koina
- J. H. Smith No ka palapala hii
- J. Kekaulaha No ka hana ana i ka la 9 o Novemaba 1848.
- No ke kope ana i na olelo a ma hoike
- No ke ana ana
- No ke kope ana
- No ka hookelele ana i ka olelo i ka la 1 o November 1853.

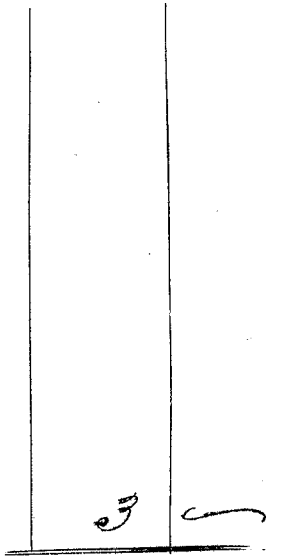

Eia na palena. Anaiia e F. S. Lyman

E hoomaka ana ma kekahi pōhaku ma kekahi Akau Komohana a e holo ana (Korm 1/2' Kōk. 2, 28 kaul. i kahi pahu, alaila Korm 85 1/4' Kōk. 2, 28 kaul. i kahi pahu hōu, alaila Ak. 1 1/2' Kōk. 2, 63 kaul. i kahi kumu laila, alaila Korm 86 1/2' Korm. 2, 52 kaul. a hiki ma ka pōhaku i hoomakai.

Maloko o keia 1/10 Eka.

1 Chain to an Inch

KONOHIKI

KONOHIKI

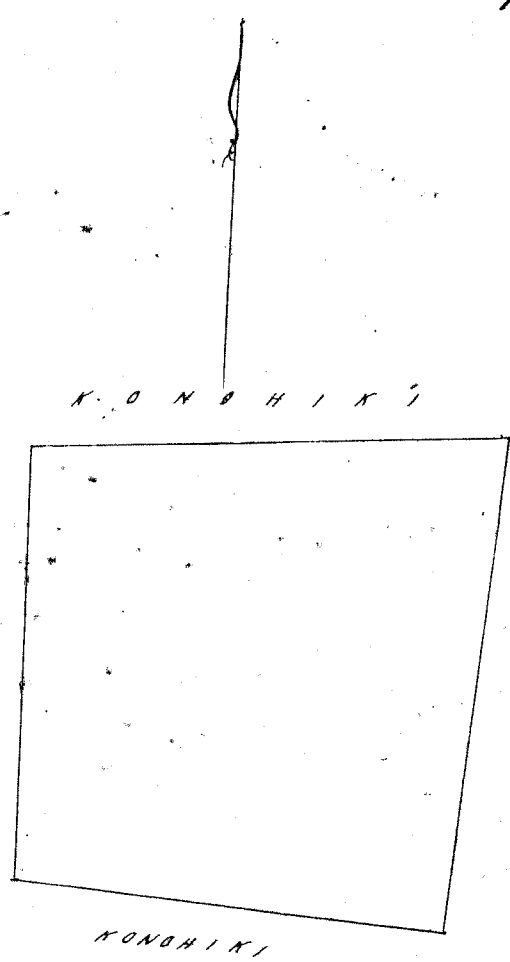

Kele 10512 Nahuina

Ua hoi mai oia no kona Aina o Kea 2nd i Koolau ma ka Moku o Maui, ma ka mea, ua loa ia ia keia aina ma ka mahale aina ana me ke Alii Kamohamohana i ka Makahiki 1848, a ua nōho kekua oleia a hiki i keia manawa.

Ua hōho ma ka hōho me i no Nahuina, he hōho ma ka hōho malalo iho o ke Aia Aloha. Ina e hōho mai oia i ke ke Aupuni hapaha, alaila, ua kōpuni ia ia ka Palapala Aia Aloha.

Pono ma ia ia he ulu no ka hōhoholo a me ka hōhoholo ana i ka olelo Puni.

- W. L. Lee
- G. M. Robertson
- J. H. Smith
- J. Kekaulaha

- No ka oomi a me ke pua ana i ka olelo ma ka Nūpepa
- No ke kope ana i ka olelo Kōkua
- No ka palapala kii
- No ka hana ana i ka la 4 o Feberuari 1853
- No ke kope ana i na olelo a ma hōke
- No ka ana ana i ka la 5 o Aperila 1853
- No ke kope ana
- No ka hōhoholo ana i ka olelo i ka la 1 o November 1853

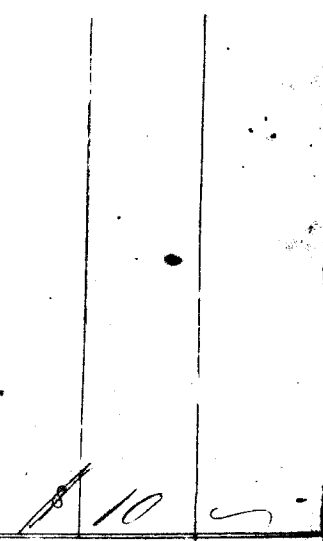

Eia na palapala

Aina o John J. Lowe

Kea 2nd Koolau, Maui E hoomaka ke ana ma kekahi Akau o keia, a e holo

Ko. 31 1/4	Ko. 13.80	th. i pili ana ma Ohianalua
Ko. 30	Ko. 30.13	" " "
Ko. 1/2	Ko. 18.47	" " " Kahuwai
Ko. 6	Ko. 11.76	" " "
Ko. 7 1/2	Ko. 13.36	" " " ka Nahuina
Ak. 9 1/4	Ko. 2.04	" " " Kea 1 st
Ak. 23 1/4	Ko. 15.23	" " "
Ak. 17 1/4	Ko. 3.34	" " "
Ak. 22 1/2	Ko. 6.89	" " "
Ak. 11 1/2	Ko. 98	" " "
Ak. 20	Ko. 11.96	" " "
Ak. 17 1/4	Ko. 24.85	" " "
Ak. 42 1/4	Ko. 7.21	" " "

a me ka palapala kaka, a hiki ma ka kiki i hoomakai, a maloko oia Aupuni John J. Lowe 1/10 Eka.

This land is ^{said} to extend to the south as indicated by the pencil marks, to the top of the mountain, some four or five miles.

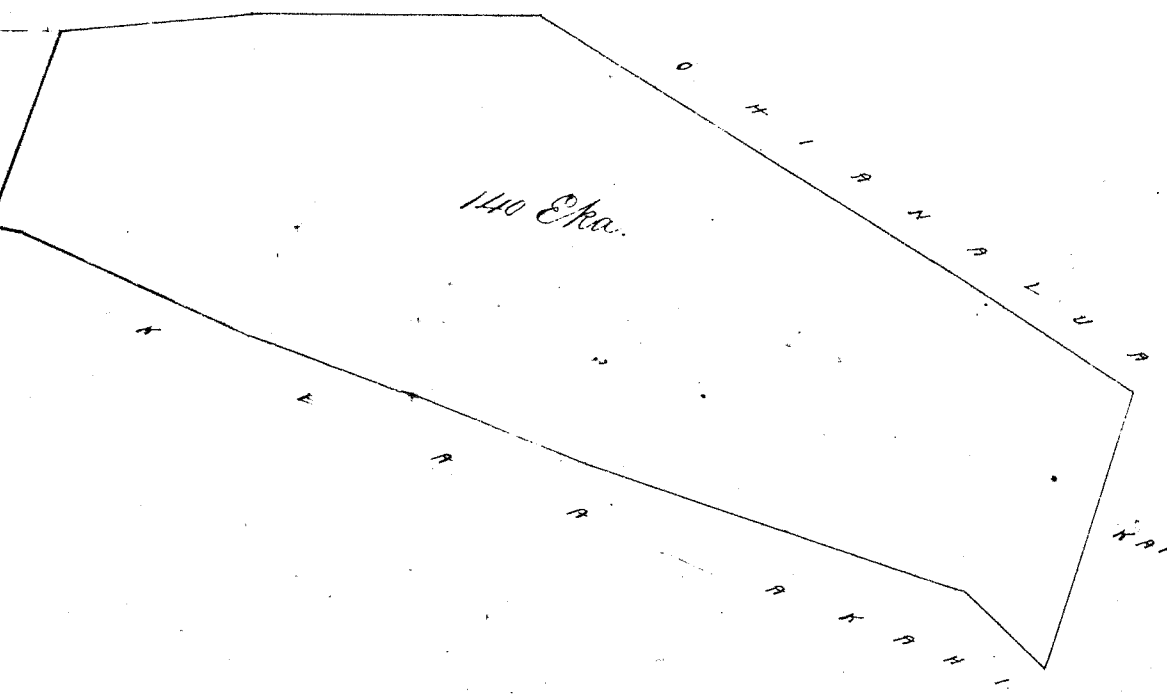

12 Chains to an Inch.

Heleu 1362 Naholowaa (no Hooa)

Ua koi mai oia no kona wahi Apana aino ma Keoneula i Honolulu, ma Kona, ma ka Mokupuni o Oahu; no ka mea, ua loa ia ia keia wahi no Hooa mai kona wahine, aka, ua hoikoihou aku no oia i ua wahi la ia Hooa kana wahine, a ua noho keia oleia a hiki i keia manawa.

Oia ka makou i hooke nei no Naholowaa a ia Hooa kana wahine; he kuleana hoikona mulah ike o ke Aue Alodio. Ima e uku ana i keia Aupuni i hapaha; alaila, ua kupaia ia ia ka Palapala Sila Alodio.

W. L. Lee
J. Kaka'aukahi
G. M. Robertson

Pono mania ia ke uku ma ka hohoholo a me ka hohoholo ana i ke olelo, Penei,
No ka rumi a me kupaia ana i ke olelo ma ka Nupapa
No ke kope ana i ke olelo ko'ino
No ka palapala kei
No ka hana ana i ka lā 22^o Sepatemaba 1848.
No ke kope ana i na olelo a me hoike 1/2 Aoa
No ke ana ana i ka lā 25^o October 1853.
No ke kope ana
No ka hohoholo ana i ke olelo ke ka lā 2^o November 1853.

Eia ma paluu. Anai a S. P. Kalama.

3

Aina ma Keoneula, Honolulu, Kona, Oahu.

I Poi. E hoimaka ma ke kahi Kona o keia mau Poi, i pili ana ma ka auwai iwaiwa o Keoneula a me Kahawali no I Kaa. E hiki ana Aka 40^o Kona. 1 Kaulahao 93 Pauku i pili ana me ka auwai o ke Konoheki a hiki i ke auwai o pili ana me Hauhauki no ke Aupuni. Alaila Aka 54^o Hikiina 2 Kaulahao 63 Pauku i pili ana ma ka lili Kona o ka auwai iwaiwa o Keoneula a me Hauhauki a hiki i ke ke Konoheki. Alaila Kona 35^o Hikiina 1 Kaulahao 64 Pauku i pili ana me ka auwai o ke Konoheki a hiki i ke auwai me Kahawali; alaila Kona 47^o 15' Kona. 2 1/2 Kaulahao i pili ana me ka lili Aka o ka auwai me Kahawali a hiki i ke hoimaka ana.

Eia ka Ii 46/100 Eka.

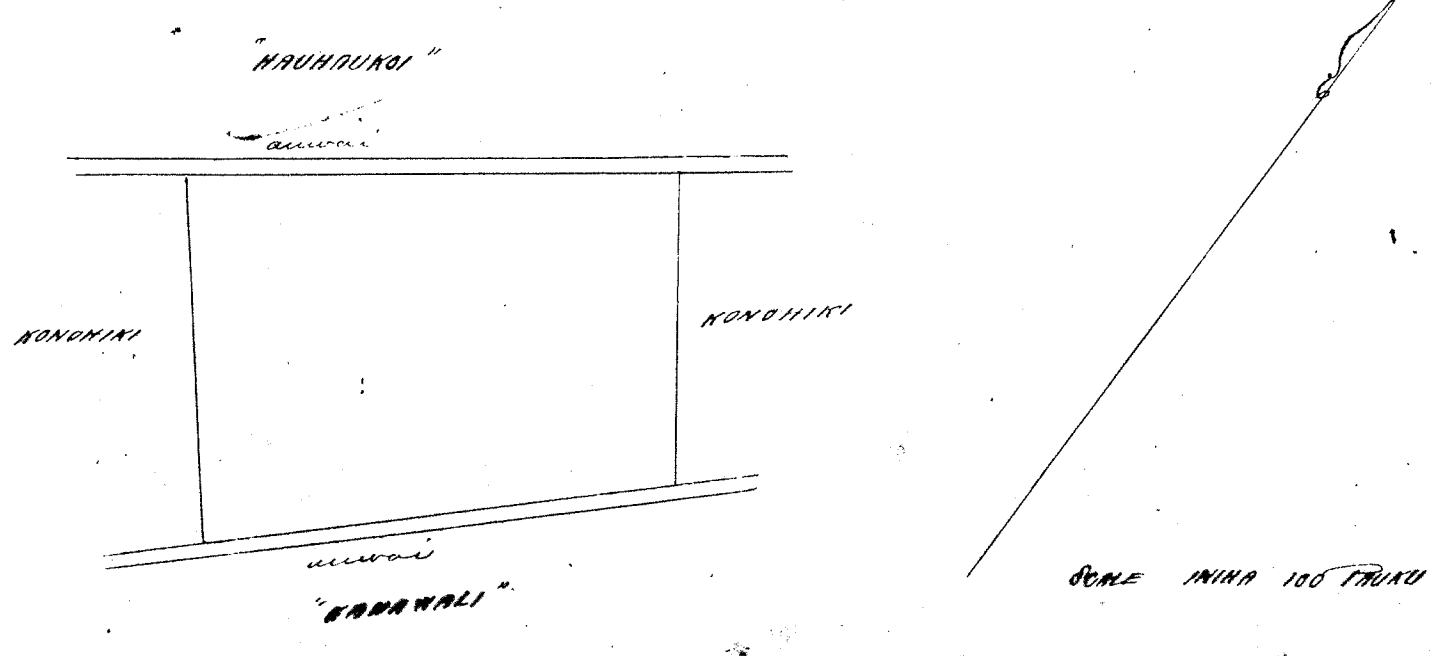

Helu 1089 Kapoho

Ua koi mai oia no kona wahi Aupuni aino ma Kuwili me Kapahaha i Honolulu me Kona, me ka Moku oia. Oahu, no ka mea, ua koi ia ia keia wahi no Kaniku mai i ka M.H. 1839 kahi me Kuwili, a me Kapahaha mai kahi me Kapahaha i ka M.H. 1844, aua noho keakea oleia a hiki i keia manawa.)

Oia ka makou i hoko me no Kapoho; he kuleana ho'i kona malalo iho oke Aua Alodio. Ina e ukou mai oia i hoko Aupuni kapaha, alaila ua kupono ia i ka Palapala Seta Alodio.

- Pono ma ia ia ke ukou me ka hooholoholo a me ka hooholo ana i ka olelo, Peni,
- No ka ukou ana i ka olelo koina
- No ka palapala kii.
- No ka hana ana i ka 14 o June 1848.
- No ka ukou ana i ma olelo a ma hooke 2/3 Aua
- No ka ana ana i ka 8 o November 1851
- No ka ukou ana
- No ka hooholo ana i ka olelo i ka 2 o November 1853.

- W. L. Lee
- G. M. Robertson
- J. H. Smith
- J. Mekauleha

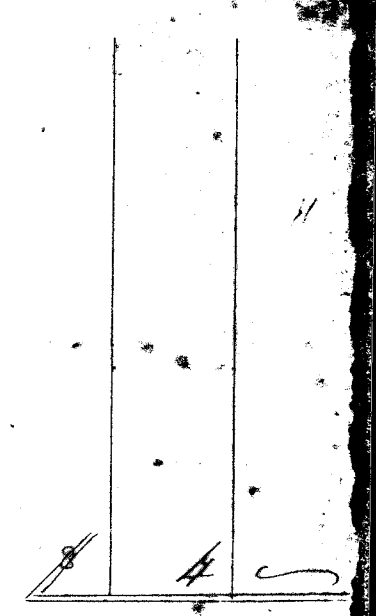

Eia ma palama. Anau o S. J. Kalama.

Ma Kuwili me Kapahaha, Honolulu, Oahu.

Pahali me 5 Loi. E hoomaka ma ka pohaku pauka i hooilomai x imaka aua Hikina i ka wai, a e holo Aka 27 Kom. 30 Kapua i ma ka Keakahiwa a hiki i ka x ma ka pali paupauka, - Alaila Aka 63 Hikina 23 Kapua, - me Aka 24 Kom. 71 Kapua, me ka pahale o Kauaia, - Alaila Aka 74 Hikina 130 Kapua ma ka Ala olelo, - Alaila Kema 30 Hikina 76 Kapua a hiki i ka lili paupauka, - Alaila Aka 64 Hikina 72 Kapua me Kapahaha no Alapai, - Alaila Kema 32 30 Hikina 42 Kapua, - me Kema 20 Hik. 106 Kapua me Aupuni a hiki i ka Kahalaaku, - Alaila Kema 74 Kom. 88 Kapua, - me Kema 12 30 Hik. 37 Kapua, - me Kema 30 Hik. 39 Kapua, - me Aka 70 30 Hik. 48 Kapua, - me Aka 82 Hik. 62 Kapua i pili ana me Kahalaaku. Alaila Kema 39 Hikina 107 Kapua me Aupuni no Laimai, - Alaila Kema 80 30 Kom. 156 Kapua, - me Kema 83 Kom. 142 Kapua me Aupuni Loko o Kuwili, - Alaila Aka 21 Kom. 47 Kapua, - me Aka 84 30 Hik. 45 Kapua, - me Aka 17 Kom. 116 Kapua, - me Aka 27 Kom. 50 Kapua, - me Aka 86 Kom. 97 Kapua me Aka 50 Kom. 37 Kapua me Kauaia a hiki i ka hoomaka ana.

Eia ka hi 1 Eka 725 Anana.

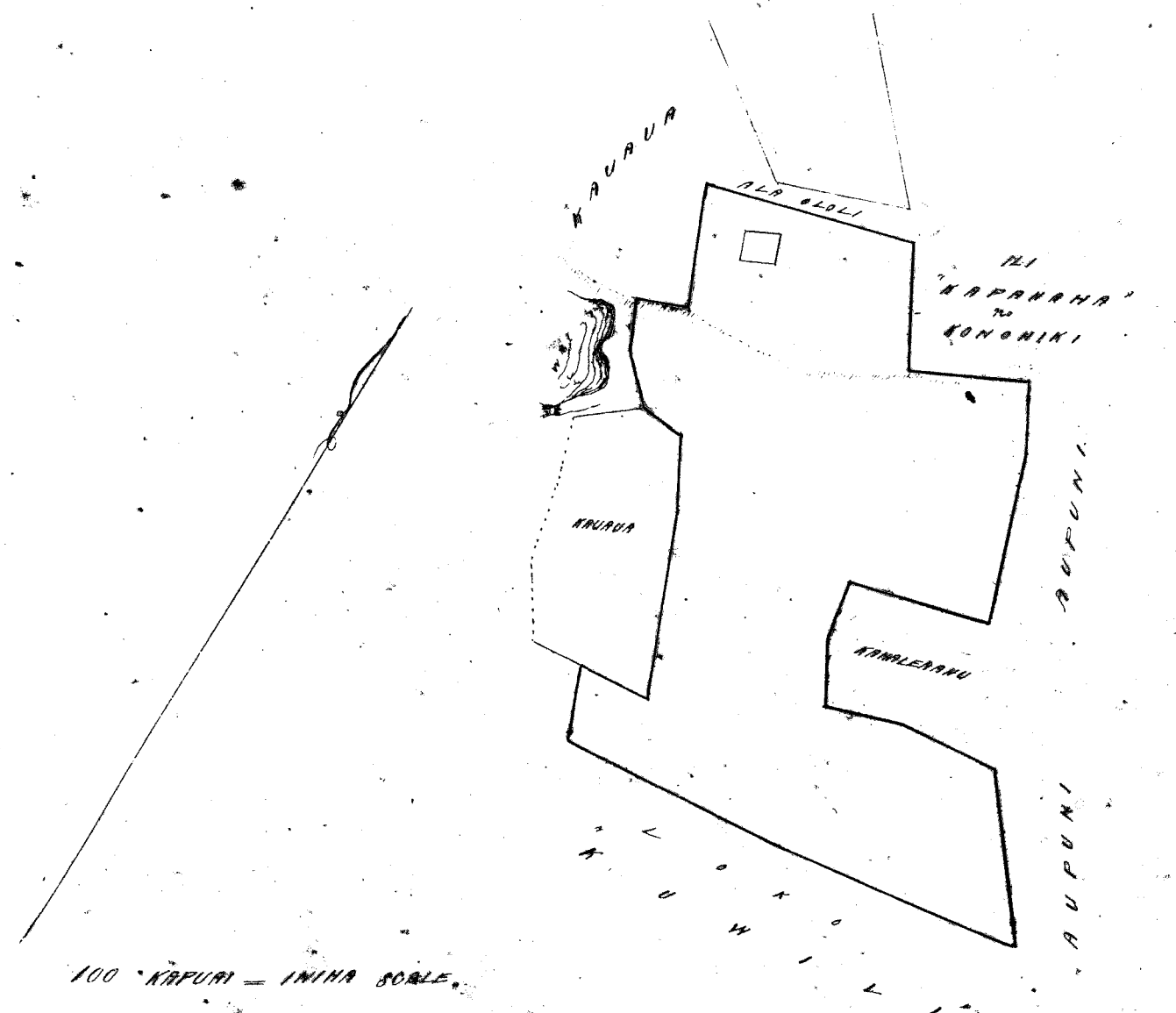

Hele 6238 Kane

Ua hoi mai oia no kona mau Apana aina ma Kaunahou a me Kahawali i Honolulu, ma Kona, ma ka Mokupuni o Oahu, me ka mea, ua loa mai ia ia ka Apana aina no Ewa mai i ka M.H. 1838, a ua loa hoi ia ia ka palapala no Holelua mai i ka M.H. 1834, a ua noho ka mea oleia a hiki i keia manawa.

Oia ka makou a hoko mai no Kane; he haleana hoi kona matato iho o ke Ano Aloha. Ina e hui mai oia iho ke Aupuni hapaha; alaila, ua kumpo ia ia ka Palapala Situa Puni Aloha.

W. L. Lee
S. K. Kaulahao
G. M. Robertson

Pono nua ia ia ke uku no ka hookeoholo a me ka hookeoholo ana i ka olelo, Penei;
No ka ramu a me ke pui ana i ka olelo ma ka Nupupu, -
No ke kope ana i ka olelo koina
No ka palapala kii
No ka hana ana i ka la 23. Septemba 1851
No ke kope ana i ka olelo a me hoi ke 1/2 aua
No ke ana ana i ka olelo la 28. Iune 1852.
No ke kope ana
No ka hookeoholo ana i ka olelo i ka la 4. Novemba 1853.

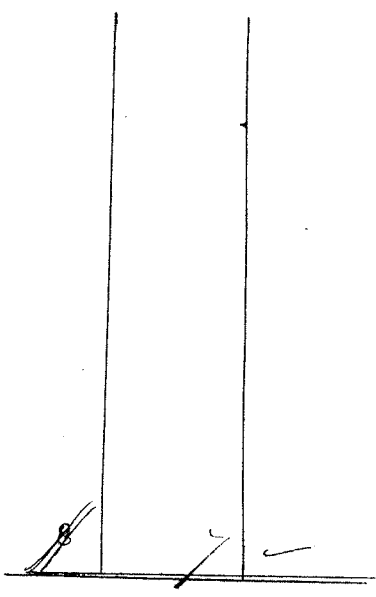

Eia ma palena. Inaia S. P. Kalamia & A. F. Turner

Ma Kaunahou a me Kahawali, Honolulu, Oahu.
Apana 1. 8 Poi ma Kahawali. E hoomaka ma ke kiki Kona, a holo Kona 57° Kikina 240 Paka me ka auwai. Alaila Kona 25° 30' Kona. 184 Paka, - a me Kona 59° Kikina 92 Paka me Pihilihi. Alaila Kona 25° Kona. 142 Paka, pili me Kahumua. Alaila Kona 57° 30' Kona. 590 Paka pili me Ewa, - Alaila Kona 34° Kikina 324 Paka pili me Kona a hiki i ka hoomaka ana. Ka Ili 1 Eka.

20 Okatoba 1851

(Inoa) A. F. Turner
Luna ana ana

Apana 2. Kahawali ma Kaunahou. E hoomaka ma ke kiki Kikina, a holo Kona 49° Kona. 144 Paka a me Kona 45° 30' Kona. 96 Paka me ka aina Aupuni a me Holelua, - Alaila Kona 40° 30' Kikina 147 Paka pili me Holelua a me Kahouiki, - Alaila Kona 42° 30' Kikina 118 Paka pili me Kahouiki a hiki i ka hoomaka ana.

Pau loa Ka Ili 1 1/100 Eka 1 1/100 Eka.

S. P. Kalamia
Ana ana

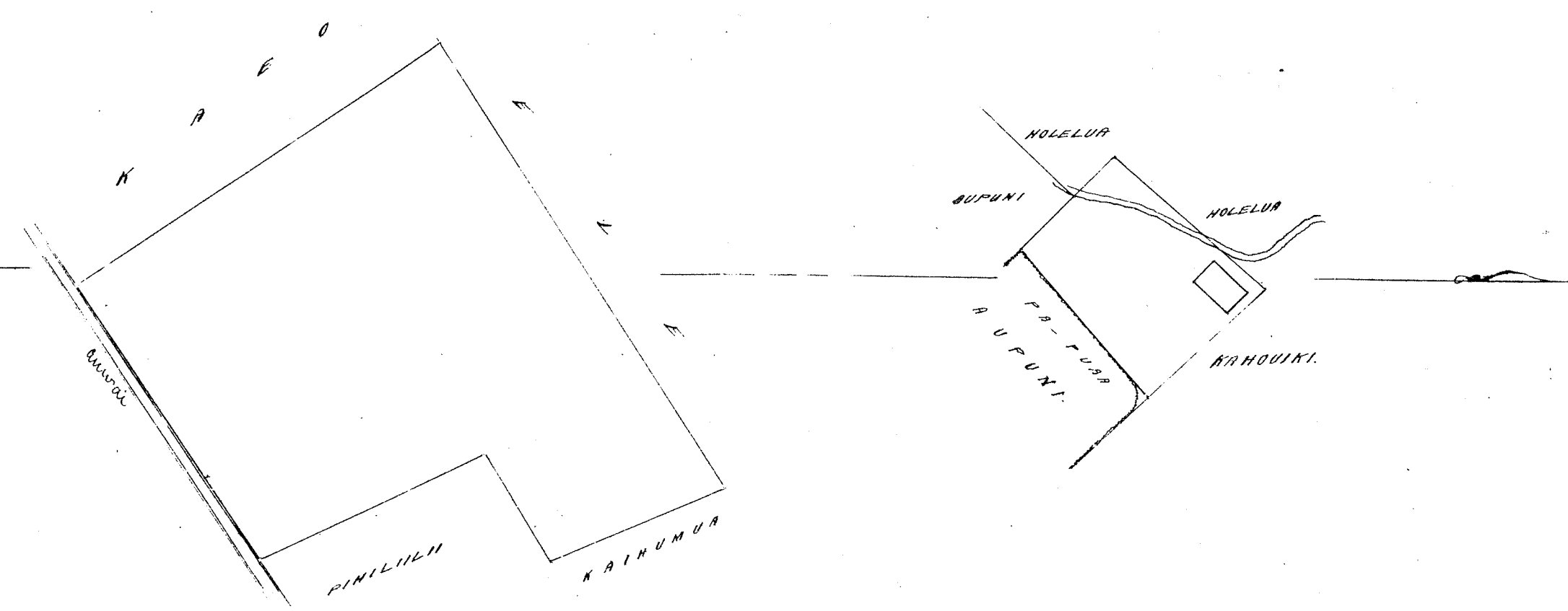

Hele 8344 Kamaiakulifu

Ua koi mai oia no kona wahi Apuna aina ma Hele i Honolulu, ma Kona, ma ka Mokupuni o Oahu; no ka mea, ua loa ia ia keia wahi no J. A. Kuakini mai i ka M. A. 1851, oia keia manawa e noho ana o J. A. Kuakini ma ka Papu o Honolulu, a ua noho no ma kela aina a hiki i ka M. A. 1847, he mea kona noho luma Honolulu ana ma kela Ili aina. Ua lawa ma ke paai ana a Mahuka ka luma malalo ake o M. Hehuanaoia. Aka, i ka manawa ana, a i ka loko ana mai i ka poe i ike ma ka, ua hana o Kamaiakulifu i ka wahi oia aina mona pono iho, me ka hana oleia ma ka luma hana koela e ma ka hana o ka aina, a no ka mea hoi, ua hoiihi loa kona mahi ana ma ua wahi la;

Kohuila, ua maopopo ia, makou, ke kuleana no ko Kamaiakulifu iho oia aina e like me ka mea i hoikeia ma ke ana a S. P. Kalama, a nohaila, ke hooke nei makou ia wahi no Kamaiakulifu; ke kuleana hoi kona malalo iho o ke Ano Alodis. Ina e iku mai oia iko ke Aupuni hapaha; alaila, ua kupo ia ia i ka Palapala Sila Alodis Pono ma ia ia ke iku no ka hooke hooke a me ka hooke ana i ka olelo. Puni.

W. L. Lee
G. M. Robertson
J. H. Emitt
J. Kaulahao

No ka ranni a me ke paai ana i ka olelo ma ka Nupapa
No ke kope ana i ka olelo koia
No ka palapala hii
No ka hana ana i ka la 19 o Dekemaba 1851.
No ke kope ana i ma olelo a ma hiki 1/3 ana
No ke ana ana i ka la 17 o Augate 1853.
No ke kope ana
No ka hooke ana i ka olelo i ka la 4 o November 1853.

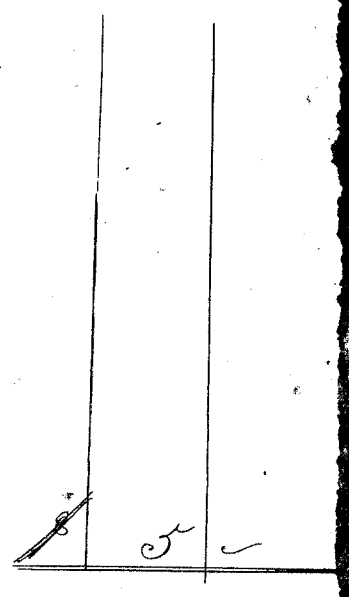

Eia ma palawa. Anaia i S. P. Kalama

Ma "Aala" Ili no Honolulu, Kona, Oahu.

1 Loni. E hooiwa ma ke kiihi Komohana Aka o keia Loni, a e hooi Komana 14 Kona. 11 Panku, - ma Kema 80 Kikina 193 Panku i pili ana me ka aina o Nahuina a hiki i ka Ili "Kamakela" no Kalaeokeke, - alaila, Aka 27° 30' Kikina 122 Panku, kiihi Kikina Aka o keia, - a Aka 81° Kona. 223 Panku ma "Kamakela" a me ka Loni o Kalaeokeke a hiki i ka hooiwa ana.

Eia ka Ili 24/100 Eka.

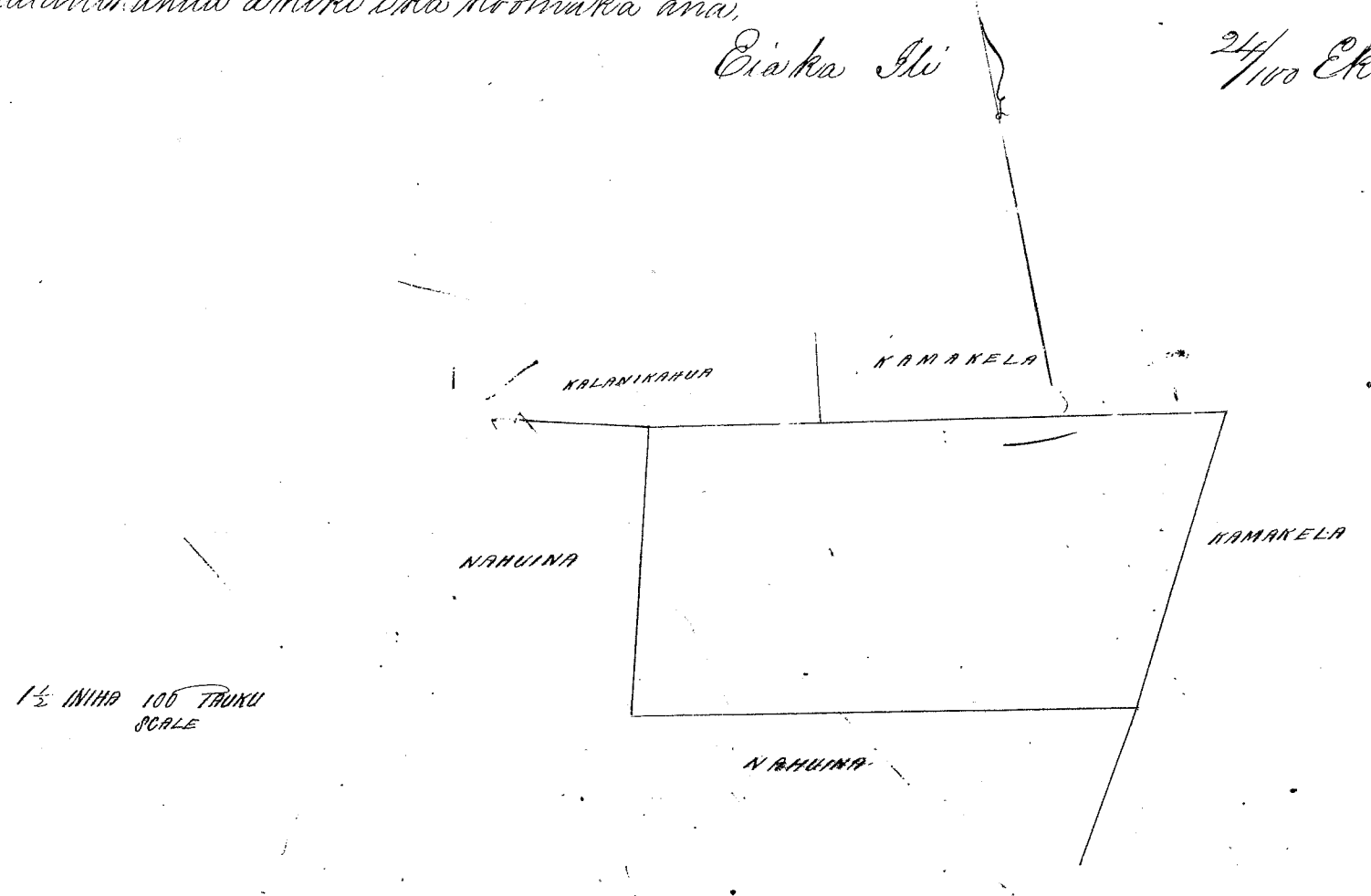

Hele 50 FL Namai

Ua koi mai oia no kona wahi ma Olohe i Honolulu ma Kona, ma ka Mokupuni o Oahu; no ka mea, ma ka hana ana o ka M. A. 1851, oia ma Aina Papu; no ka mea, ua loa ia ia keia wahi no Paahana mai i ka wahi e la ana o Kivua, a ma noho keakea oleia a hiki i keia manawa.

Oia ka makou e hooke nei ma Namai; ke kuleana hoi kona malalo iho o ke Ano Alodis. Ina e iku mai oia i ko ke Aupuni hapaha; alaila, ua kupo ia ia i ka Palapala Sila Alodis.

Pono ma ia ia ke iku no ka hooke hooke a me ka hooke ana i ka olelo

W. L. Lee
J. Kaulahao
G. M. Robertson

No ka ranni a me ke paai ana i ka olelo ma ka Nupapa
No ke kope ana i ka olelo koia
No ka palapala hii

No ka hana ana i ka lā 24 o Feberuari 1852.
 No ke kope ana i ma olelo ama hoike 1/2 Awa
 No ke ana ana i ka lā
 No ke kope ana
 No ka hoo holo ana i ka olelo i ka lā 4 o November 1853.

65

Eia na palena. Anaia e S. P. Katania

Ma Oloku Ili no Honolulu, Oahu.

Ap. 1. Kula maha i Kahuahale. E hoomaka ma ke kahi Akau, a e holo Kema 44° 45' Kom. 432 Puka i pili ana me Kama, Kapali, ame Aupuni a hiki i ke kahi Komohana, Alaila Kema 52° Hikiina 2 Kaulahao me Aupuni, Alaila Akau 43° 30' Hikiina 436 Puka me S. Kaulahao, Alaila Akau 54° Kom. 198 Puka me ke Alanui Sudd a hiki i ka hoomaka ana. Ka Ili 7/8 Eka.

Ap. 2. 1 Poi. E hoomaka ma ke kahi Komohana Akau, a e holo Kema 54° 45' Hikiina 253 Puka me Aupuni, Alaila Kema 37° Kom. 91 Puka me Kiu, Alaila Akau 64° Kom. 100 Puka, ame Akau 56° 30' Kom. 155 Puka me Lolo, Alaila Akau 39° 30' Hikiina 92 Puka me Aupuni a hiki i ka hoomaka ana. Ka Ili 25/100 Eka

Ap. 3. 8 Poi. E hoomaka ma ke kahi Akau, a e holo Kema 54° Hikiina 270 Puka me Lolo, Alaila Kema 39° 30' Kom. 179 Puka, ame Kema 43° Kom. 221 Puka, ame Akau 47° Kom. 60 Puka me Kama a hiki i ka auwai o Kalo, Alaila holo ma ka auwai e holo ana i Kama a hiki i ke kahi Kema o ka aia o Polukua, Alaila Akau 36° Hikiina 265 Puka i pili ana me Polukua, Ma ka kaulahao o Mahoe, Alaila Akau 39° 30' Hikiina 57 Puka i pili ana me Aupuni a hiki i ka hoomaka ana. Ka Ili 91/100 Eka.

Pau loa 2 3/2/100 Eka.

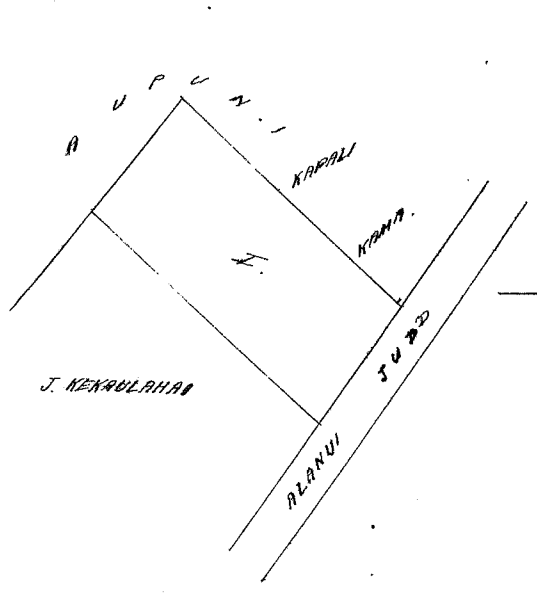
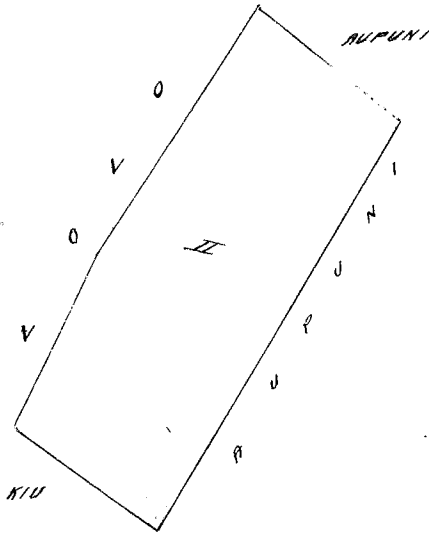
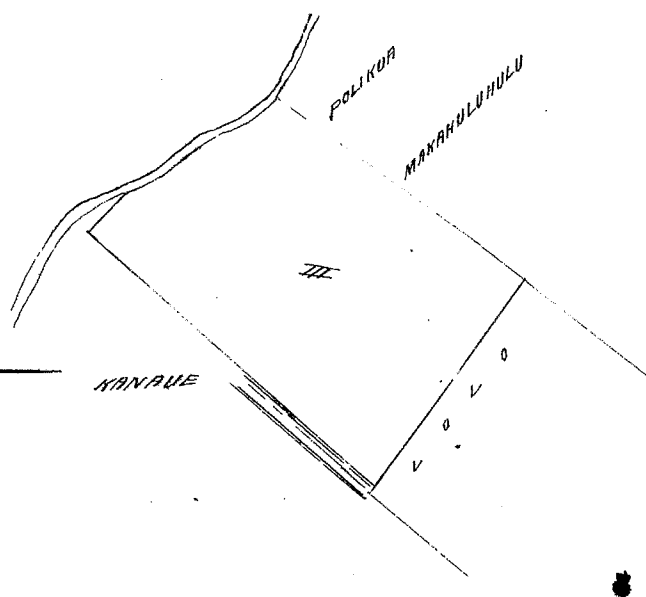

Sheu 53 FL Mahoe

From Page 126 of 9 awards

Ma kei mai oia no kona mau Apana ana ma Kaulahao i Honolulu ma Kona, ma ka Mokupuni o Oahu, no ka mea, ua loaa ia ia keia mau wahie ma Keauiaole mai Kona ma ka lā 2 o Januari 1841, a ua loaa hoi ia Keauiaole kona ma ka lā 13 o Aukani mai i ka (M.S. 183), a ua noho ke keia olelo a hiki i keia mau wahi.

Oia ka makou e hooke nei no Mahoe, ke huleana hoi kona matato iho o ke Ano-Atodis. Ina e ulu mai oia i ke Aupuni hapaha, alaila, ma kumpo ia ia ka Palapala Sita Atodis.

W. L. Lee
 J. Kaulahao
 G. M. Robertson

No ka rumi a me ke hui ana i ka olelo ma ka Nupepa
 No ke kope ana i ka olelo koia
 No ka palapala hii
 No ka hana ana i ka lā 2 o Maraki 1852.
 No ke kope ana i ma olelo ama hoike 1 Awa
 No ke ana ana i ka lā 13 o Augate 1852.
 No ke kope ana
 No ka hoo holo ana i ka olelo i ka lā 4 o November 1853.

Ken.

Ma Kauhakohu Nuanu Honolulu, Oahu.

Ap. 1. 2 Loi me Kula. E hoomaka ma ka pihiki Kula o keia e pili ana me ka pihiki Kihina o ke Kula o Kauhakohu, - A e holo Akau 46° Kom. 154 Panku ma ka pihiki Kula o Kauhakohu, - Alaila Kema 48° 45' Kom. 166 Panku, - ame Kema 48° 30' Kihina 43 Panku, - ame Kema 19° Kihina 21 Panku e pili ana me Nomaile, - Alaila Kema 47° 30' Kihina 32 Panku, - ame Akau 48° Kihina 80 Panku, - ame Kema 43° Kihina 55 Panku e pili ana me I no Kainawe a hiki i ke Auwai, - Alaila Akau 52° 30' Kihina 86 Panku ma ka auwai me Auwani a hiki i ke hoomaka ana. Ka Ili 2 1/100 Eka.

Ap. 2. 2 Loi. E hoomaka ma ke kiki Kema o keia e pili ana me ke kiki Kihina o ke Kula o Kauhakohu, - A e holo Akau 41° 45' Kihina 174 Panku, kiki, - ame Akau 45° Kom. 239 Panku me ka auwai Auwani ame ko Kuaana, - Alaila Kema 38° 45' Kom. 92 Panku, - ame Akau 50° Kom. 187 Panku, - ame Kema 40° 15' Kom. 82 Panku e pili ana me Kuaana a hiki i ke kiki Komohana Akau matuai, - Alaila Kema 47° Kihina 420 Panku e pili ana me Kuaana a me ke Kula o Kauhakohu a hiki i ke hoomaka ana. Ka Ili 5 1/100 Eka.

Ap. 3. Moos Kalo. E hoomaka ma ke kiki Kema o keia e pili ana me ka pihiki Kihina o I no Kauhakohu ame ko Kaulamakule, - A e holo Akau 25° Kihina 84 Panku e pili ana me I no Kauhakohu ame M. Kekauonohi, Alaila Akau 37° Kihina 113 Panku, kiki Kihina o keia, - ame Akau 45° Kom. 67 Panku e pili ana me ka fau auwai o M. Kekauonohi, Alaila Akau 49° Kom. 443 Panku, - ame Akau 59° Kom. 77 Panku e pili ana me Kauhakohu, - Alaila Kema 27° 30' Kom. 80 Panku, - ame Kema 54° Kihina 50 Panku, - ame Kema 34° 30' Kom. 130 Panku e pili ana me Kaulamakule, - ame Kema 2° Kihina 34 Panku me Kawahapala, - Alaila Kema 45° Kihina 206 Panku me ka Loi o Pi i Kuaana o Kalo ia Moahoe, - Alaila Akau 48° Kihina 149 Panku, - ame Kema 45° Kihina 148 Panku, - ame Kema 29° Kom. 100 Panku e pili ana me ke auwai o Pi, - Alaila Kema 55° Kihina 115 Panku me ke auwai o Kaulamakule a hiki i ke hoomaka ana. Ka Ili 1 1/100 Eka.

Ap. 4. Aina Kalo. E hoomaka ma ke kiki Kihina Akau, - A e holo Kema 48° Kom. 106 Panku me Pi, Alaila Akau 42° Kom. 156 Panku me Kawahapala, - Alaila Akau 37° Kihina 62 Panku, a Akau 47° 30' Kom. 22 Panku, a Akau 37° Kihina 43 Panku, pili me Kaulamakule, - Alaila Kema 42° Kihina 2 Kaulamakule me ke auwai o Pi a hiki i ke hoomaka ana, Ka Ili 2 1/100 Eka.

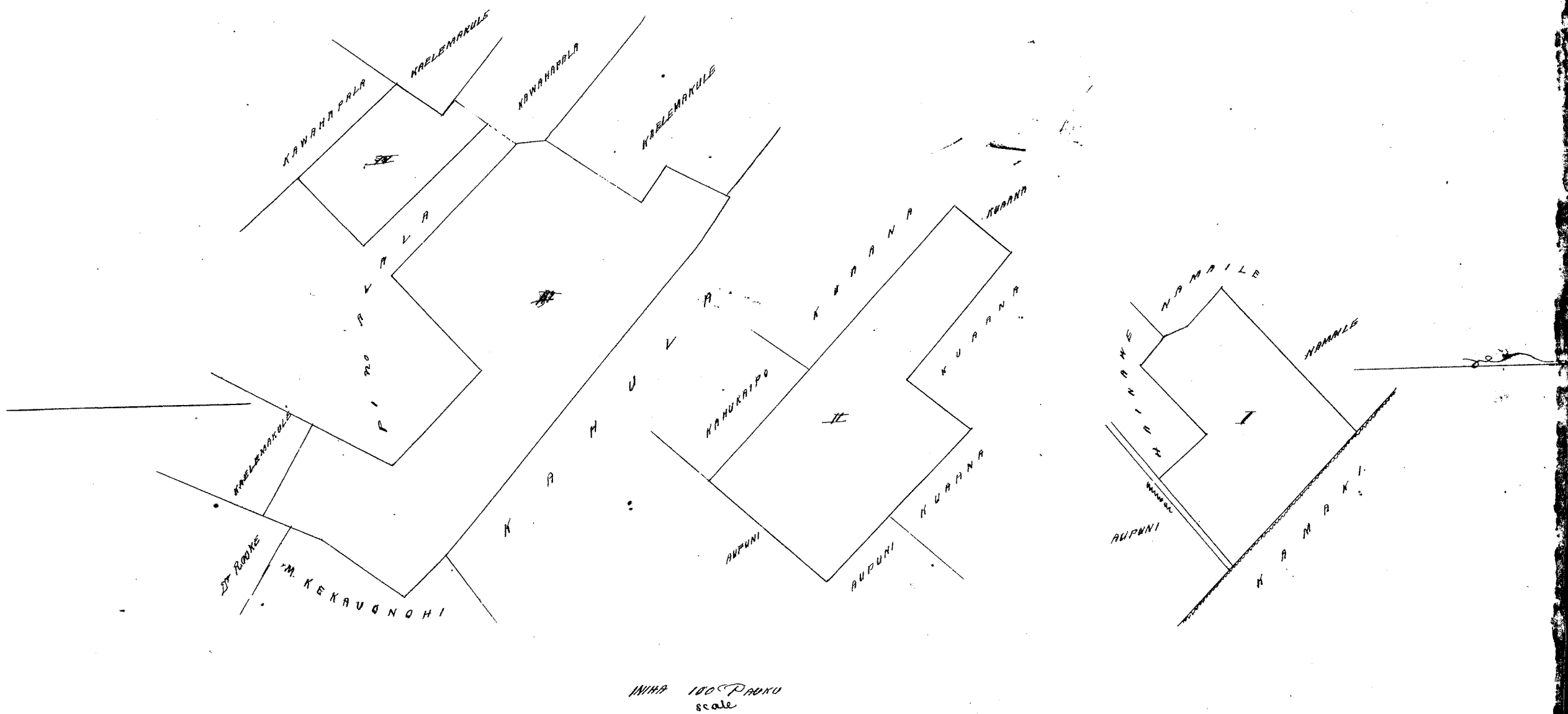

Olelohoakaka. O keia kula ana o Moahoe, ua kono ~~ma~~ iloko o ka Apana 3+4 ma Apana aia. Iane hailua, no ka haawi lilo ana mai o Kanehailua me ka hoihoi ana mai no Moahoe ua mau wahi ke auwai ana i hokuleana ai. Nalaila ua hui o Moahoe i ke la mian Apana a fau ma kona ana, a oia ana ana a Moahoe ka pono, no ka mea, mona no ia aia manua, a nolaila no ka hoihoi ana mai o Kanehailua i Moahoe. Ole

Heleu 7 FL Kahula

Ua koi mai oia no kona wahi ma Palikea i Honolulu, ma Kona, ma ka Mokupuni o Oahu, a hiki mai na Kanawai o ka makahiki 1851, no na aina Papu, no ka mea, ua loa iaia kua wahi no Kaikunakaa, mai i ka haunaele a Kuoni i ka M. A. 1833. a ua noho keakea oia a hiki i keia manawa.

Oia ka makou a hoko mai no Kahula, ke kuleana hoi, kona makalo iho o ke Awo Alodis. Ina e ukw mai oia i ke ke Aupuni hapaha, alaila, ua kupaona ia ia ka Palapala Sila Alodis.

~~Oia ka makou a hoko mai no Kahula, ke kuleana hoi, kona makalo iho o ke Awo Alodis. Ina e ukw mai oia i ke ke Aupuni hapaha, alaila, ua kupaona ia ia ka Palapala Sila Alodis.~~

Papau iaia ke ukw no ka hoko hoko a me ka hoko hoko ana i ka olelo. Penei;

W. L. Lee
J. Kapaubaha
G. M. Robertson

No ka runu a me ke papu ana i ka olelo ma ka Nupepa.
No ke kope ana i ka olelo koina
No ka palapala kii
No ka hana ana i ka la 29 o Maraki 1852.
No ke kope ana i wa olelo a ma hoi ke 1/3 aoo.
No ke ana ana i ka la 27 o Maraki 1852.
No ke kope ana
No ka hoko hoko ana i ka olelo i ka la 4, o November 1853.

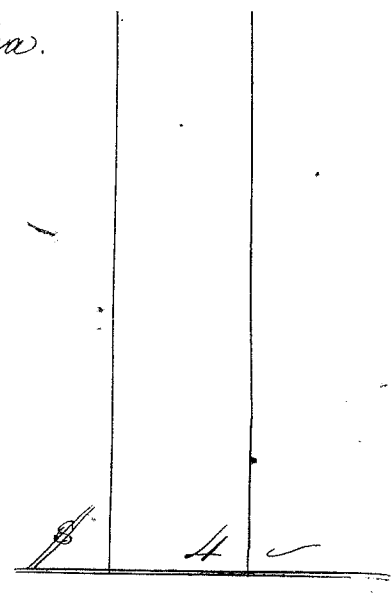

Eia na patawa.

Anaia e S. P. Kalama.

Ma Palikea, Nuuanu, Honolulu, Oahu.

20 Poi. E hoomaka ma ke kiki Kema o keia aina e pili ana me ka aina o M. Sekaunohi a me ke Mahoe, - a e holo Akau 49° Kom. 443 Panku, - a Akau 59° Kom. 77 Panku a neikawai 4 Panku, e pili ana me ke Mahoe a hiki i ke Kaalamakule, - alaila Akau 46° Kom. 88 Panku e pili ana me Kaalamakule, - alaila Akau 32° Kom. 333 Panku e pili ana me Aupuni, - alaila Kema 41° 30' Kikina 125 Panku, a Kema 48° 30' Kikina 140 Panku, a Akau 53° 45' Kikina 14 Panku, - a Kema 76° Kikina 37 Panku, a Akau 53° Kikina 31 Panku e pili ana me ke Kahawai, - alaila Kema 43° Kikina 134 Panku e pili ana me ka aina o ke Aupuni, - alaila Kema 46° Kom. 57 Panku, - a Kema 8° Kom. 24 Panku, - a Kema 40° 30' Kom. 88 Panku, a Kema 36° Kikina 142 Panku, a Kema 44° Kom. 38 Panku, a Kema 37° Kikina 122 Panku e pili ana me ke Pahili, - alaila Kema 42° 30' Kom. 20 Panku, a me Kema 59° 15' Kom. 73 Panku, pili ana me M. Sekaunohi a hiki i ka hoomaka ana.

Eia ka Iki 1/100 Eka.

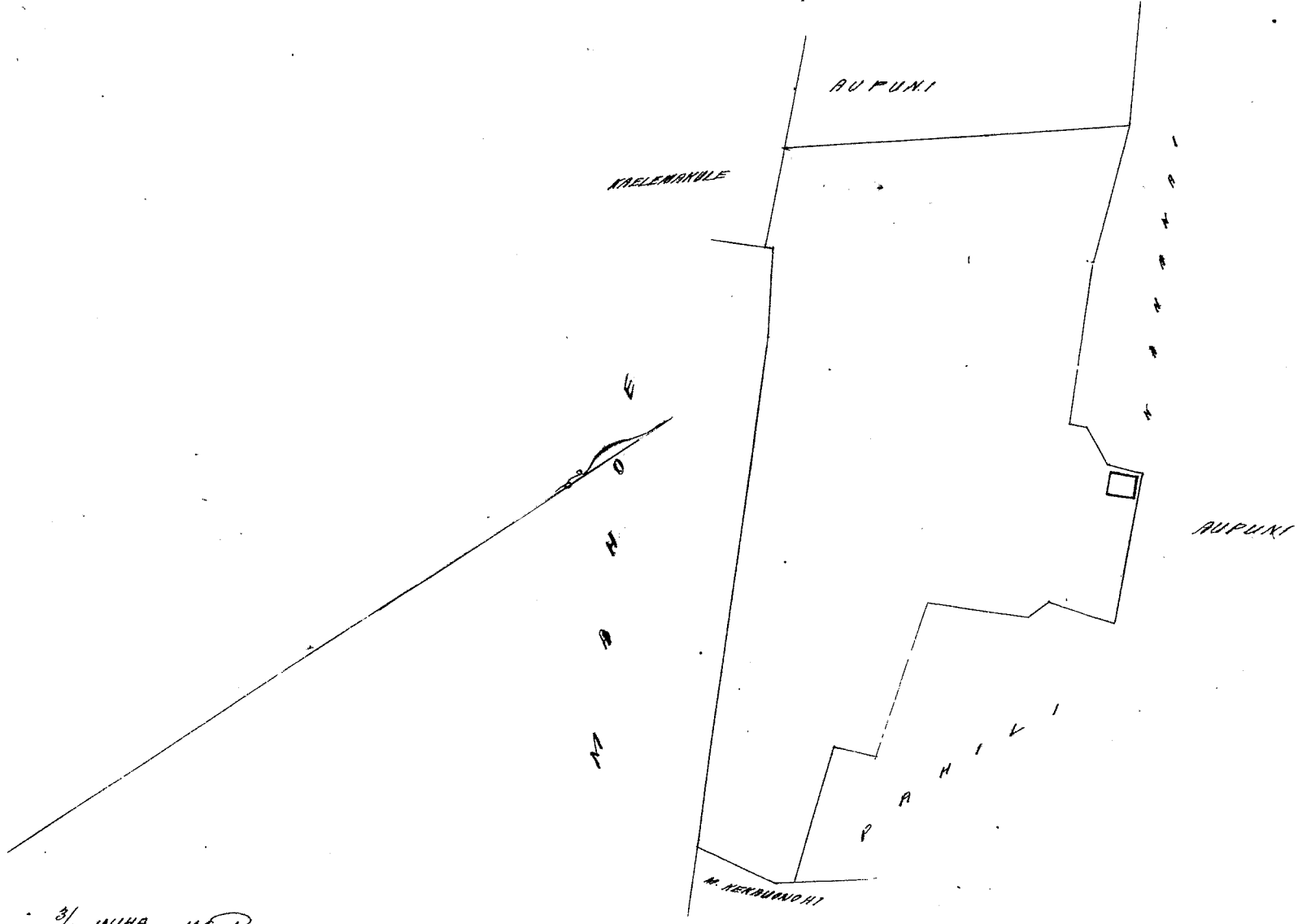

3/4 INCH 100 PANKU SCALE

Ua koi mai oia no kona wahi Apiana aina ma Puukapu lele o Niupai'apai, Nuuanu i Honolulu, ma kona, ma ka Moku'opuni. Oahu; no ka mea, ua loaa iaia keia wahi no Kaiwi mai i ka wa no e'ole ana o Hinan; a ua noho keakea oia a hiki i keia manawa.

Oia ka makou e ho'oko nei no Kaluakine; he kuleana hoi kona matata iho o ke Ano Alo'ia. Ina e uku mai oia i ke ke Aupuni hapaha; alaila, ua kufono ia ia ka Palapala Sila Alo'ia.

Pono nae iaia ke uku no ka ho'okolo'olo a me ka ho'oholo ana i ka olelo. Penei

No ka nuni a me ke piai ana i ka olelo ma ka Niupai'apai

No ke kope ana i ka olelo ko'ina

No ka palapala kii

No ka hana ana i ka la 1 o August 1853

No ke kope ana i ma olelo ana i ka 1/3 o nae

No ke ana ana i ka la

No ke kope ana

No ka ho'oholo ana i ka olelo i ka la 7 o November 1853

W. L. Lee

G. M. Robertson

J. H. Smith

J. K. Kaulahao

Oia na palena

Inaia e J. P. Kalama

Puukapu Lele Niupai'apai Nuuanu, Honolulu, Oahu.

3 Loi me Kula. E ho'owaka ma ke kahi Hikina Kama o ka Apiana aina 3 o Kuapuu ma Kahawai; Ar holo Akaw 79° Kom. 148 Paku, hiki i ka auwai, - a me Akaw 19° Hikina 69 Paku me Kuapuu, - Alaila Akaw 48° Kom. 175 Paku me Dr. Rooke a hiki i ke kahi Hikina o ka Apiana aina 2 o Kuapuu, - Alaila Kama 27° Kom. 226 Paku ma ka kahi Kama o ka auwai, - a me Kama Lima Akaw 12 Paku i pili ana me Kuapuu e meka ana i ka auwai; Alaila Kama 15° Kom. 57 Paku ma ka kahi Akaw o ka auwai kama kama o keia me ka aina o Dr. C. H. H. Alaila Kama 54° 30' Hikina 156 Paku, - a me Kama 38 Kom. 82 Paku i pili ana me ka auwai a me ka Loi ko'le Aupuni a hiki i ke Pikai, - Alaila Kama 72° 15' Hikina 219 Paku, pili me Pikai a hiki i ka hawaii, - Alaila pili i ka ma Kahawai a hiki i ka hoomaka ana

Oia ka Ili

He ka

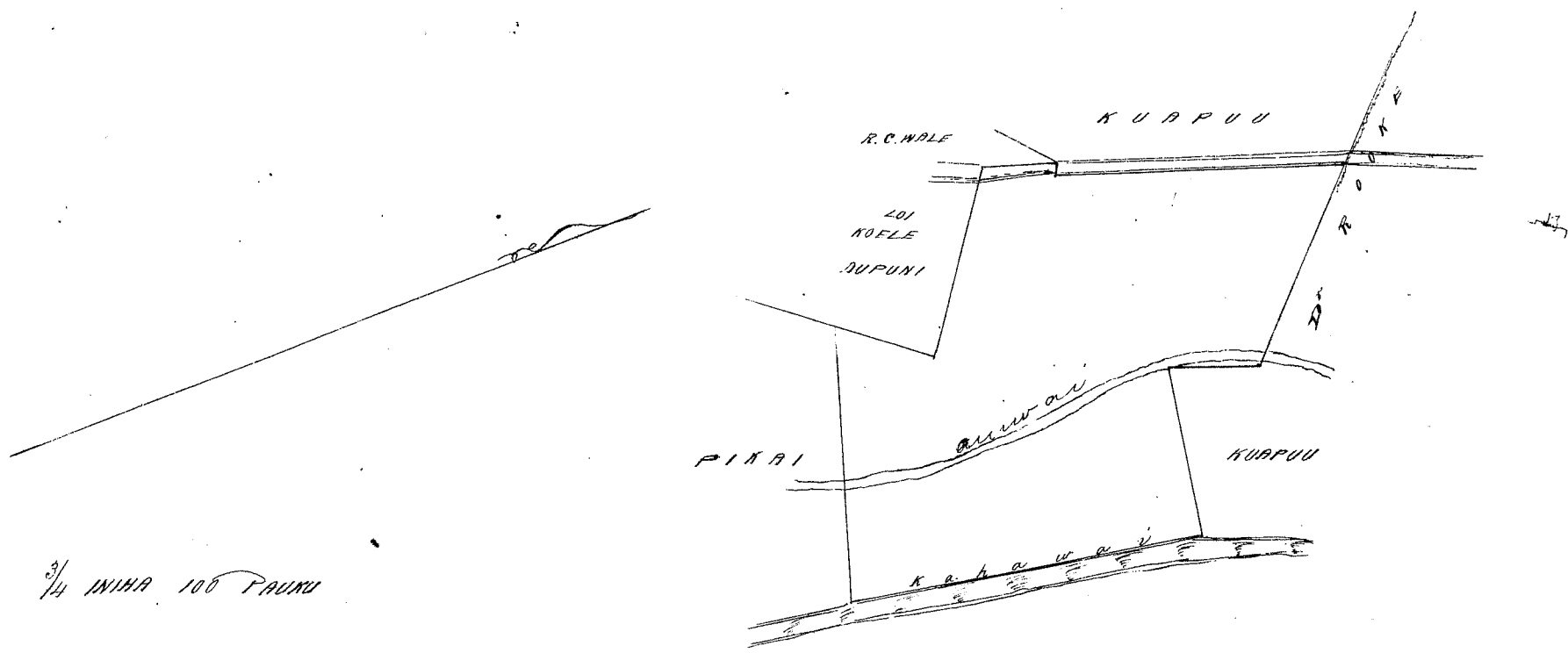

Ua koi mai oia no kona wahi ma Niupai'apai i Honolulu, ma kona, ma ka Moku'opuni. Oahu; no ka mea, ua loaa iaia keia mau wahi no Dr. Kekuanana mai i ka M. H. 1846, a ua noho keakea oia a hiki i keia manawa.

Oia ka makou e ho'oko nei no A. Kaiwi; he kuleana hoi kona matata iho o ke Ano Alo'ia. Ina e uku mai oia i ke ke Aupuni hapaha; alaila, ua kufono ia ia ka Palapala Sila Alo'ia.

Pono nae iaia ke uku no ka ho'okolo'olo a me ka ho'oholo ana i ka olelo. Penei

No ka nuni a me ke piai ana i ka olelo ma ka Niupai'apai

No ke kope ana i ka olelo ko'ina

No ka palapala kii

No ka hana ana i ka la 23 o Iulai 1853

W. L. Lee

G. M. Robertson

J. K. Kaulahao

No ke kope ana i na olelo u na hoike
No ke ana ana i ka la 3 o Augate 1852.
No ke kope ana
No ke hooholo ana i ka olelo i ka la 7 o November 1853.

Oia na huahua.

Anaia o S. P. Kalama.

4

Anaia ma Niupaiapai, Honolulu, Kona, Oahu.

Ap. 1. 1 Poi. E hoomaka ma kekiki Hikina, E holo ana Hema 44 30' Hikina 44 Pautu, pili me Koni Ana, - Hema 55 15' Kom. 65 Pautu, pili me Puabalo me S. Pikois, - Akau 40 15' Kom. 124 Pautu, pili me Aupuni me Nihonui, - Akau 36' Kom. 105 Pautu, - Akau 30 30' Kom. 31 Pautu, pili me Nihonui, - Akau 60' Hikina 56 Pautu, - Akau 73' Hikina 20 Pautu pili me Kauhau me Koni Ana, - Malaila aku me Koni Ana a hiki i ka hoomaka ana
Ka Ii 7700 Eka

Ap. 2. 13 Poi. E hoomaka ma kekiki Hema ma ka lili Hema o ke Kahawai, E holo ana Hema 64 45' Hikina 80 Pautu, a meene kupono Lima Hema 10 Pautu, - me Hema 74' Hikina 162 Pautu, Akau 81 15' Hikina 25 Pautu pili me Noha me Kaikawai ma ka Ii o "Nini", - Malaila Akau 74 Degree Hikina 46 Pautu, - Akau 32' Hikina 44 Pautu, - Akau 2 30' Kom. 90 Pautu, - Akau 83 30' Kom. 47 Pautu, - Akau 3 15' Hikina 87 Pautu, - Akau 8' Hikina 154 Pautu, - Akau 77 30' Kom. 137 Pautu, pili ana me Nihiakua a hiki i ka Kahawai, - Malaila iho pololei ma Kahawai a hiki i ka hoomaka ana,
Ka Ii 7700 Eka.
Pauoa ka Ii 7700 Eka.

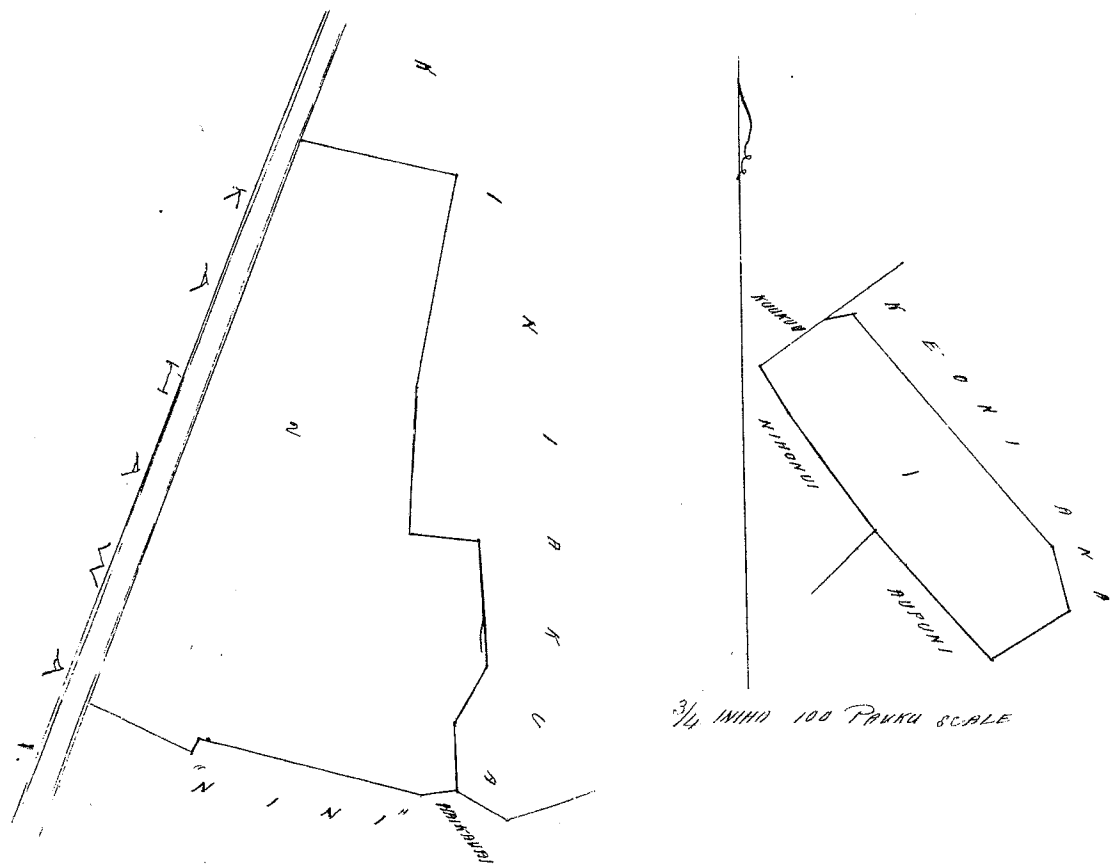

Heleu 5524 L. Konia

Part I.

Wakoi mai oia no kona aina o Napili, James, ke maui Ahupuaa ma Kaanapali, ma ka Poku-puni o Maui, no ka mea, ua loa ia ia keia mau aina no ke Alii Kamehameha III mai i ka Mahalo aina ana i ka Mo. H. 1848, a ua noho keu ka olelo a hiki i keia manawa.

Oia ka makou e hooke nei no L. Konia, ke kuleana hoike ma malalo iho o ke Ano Alodis. Ina e uku mai oia i ke ke Aupuni hapaha; alaila, ua kupono ia ia ka Palapala Lila Alodis. Aka, koe nae ma kuleana o ma kanaka maloko.

- Pono mai ia ia ke ukou no ka hooholo ana i ka olelo, Penei -
- W. L. Lee
- G. M. Robertson
- J. H. Smith
- J. Kekaulaha

No ka rumi a me ke pai ana i ka olelo ana i ka Niupaiapai,
No ke kope ana i ka olelo koima
No ka palapala kei
No ka hana ana i ka la 28 o June 1853.
No ke kope ana i na olelo ana i hoike
No ke ana ana i ka la 18 o Januari 1852.
No ke kope ana
No ka hooholo ana i ka olelo i ka la 8 o November 1853.

Napili 1, 2, 3, no L. Konia ma Kaanapali, Maui

E hoomaka ana ma ke kahi Komohana Maui makai a e holo ana,

Hei. 41°	Hei. 107	Pauku e pili ana Komokahua
Hei. 76°	Hei. 19,30	" " "
Hei. 57°	Hei. 40,25	" " "
Hei. 43°	Hei. 11,68	" " "
Hei. 55 1/2	Hei. 25,85	" " "
Hei. 67 1/4	Hei. 18,50	" " "
Hei. 71°	Hei. 8,70	" " pohaku
Hei. 76 1/2	Hei. 11,16	" " Komokahua
Hei. 42°	Hei. 16,85	" " "
Hei. 39°	Hei. 15,80	" " "
Hei. 47°	Hei. 24,30	" " "
Hei. 38°	Hei. 19,10	" " "
Hei. 51°	Hei. 24,00	" " "
He. 64°	He. 17,70	" " Napili no Mo'i
He. 78°	He. 28,60	" " "
He. 56"	He. 41,50	" " "
He. 52 1/2	He. 28,70	" " "
He. 68°	He. 60,65	" " "
He. 48°	He. 29,40	" " ma ke kahakai, alaila e pili ana

ma kai o ka wai mai a hiki i ka hiki i hoomaka'i

498 Eka.

Napili I.

E hoomaka ana ma ke kahi Komohana Maui a e holo ana

Hei. 44 1/2	Hei. 421	pauku e pili ana Komokahua
Hei. 22 1/2	Hei. 487	" " " 8 Pali
Hei. 52 1/2	Hei. 945	" " "
Hei. 39°	Hei. 405	" " "
Hei. 72°	Hei. 25,30	" " "
Hei. 41 1/2	Hei. 10,30	" " "
Hei. 38°	Hei. 8,20	" " "
Hei. 18°	Hei. 8,20	" " "
Hei. 43°	Hei. 6,20	" (kahi mauka) "
Hei. 44°	Hei. 4,15	" " "
He. 68°	He. 14,80	" e pili ana Komokahua
He. 54°	He. 29,30	" " "
He. 68 1/2	He. 5,50	" " "
He. 40 1/2	He. 27,20	" " "
He. 32°	Hei. 7,00	" " "

Napili 2, 3. i ke kahi mua. 103 Eka.

498

601

Kulu 5524 L. Konia

Part 2

Ma ke kahi mai cia no kona mau Ahupua'a o Komokahua 1 & 2, ma Kaanapali, ma ke Mokupuni ma'i o Maui; no ke mea, ua loaa ia i keia mau aina no ke Alii Hamakua III ma'i ma ke Mahi'ala ana ana i ka MoA. 1848, a ua noho keakea oleia a hiki i keia manawa.

Cia ka mau e hoko mai no L. Konia, he kuleana ho'i kona malalo iho o ke Awa Alodis. Ina e ukua mau oia i ke ke Ahupua'a hapaha; alaila, ua kupa no ia i ke Palapala Lita Alodis. Aka, he mau ma ke lea o na kuleana malalo.

Pono na ia ia ke ukua ma ke hoko kolo a ma ke hoko ana i ke olelo, Penei,

- W. L. Lee
- G. M. Robertson
- J. H. Smith
- J. H. Kaulahao
- No ke kahi oumi a me ke pili ana i ke olelo ma ke Mokupuni.
- No ke kahi oumi a me ke pili ana i ke olelo ma ke Mokupuni.
- No ke kahi oumi a me ke pili ana i ke olelo ma ke Mokupuni.
- No ke kahi oumi a me ke pili ana i ke olelo ma ke Mokupuni.

No ke kahi oumi a me ke pili ana i ke olelo ma ke Mokupuni.

No ke kope ana i na olelo a ma hoike
 No ke ana ana i ka lā 13 o Januāri 1852
 No ke kope ana
 No ke hooholo ana i ka olelo i ka lā 8 o Novemba 1853.

5 ✓

Cia ma palena. Anaias e A. F. Turner

Honokahua 1 amē 2. Kuanapali Maui.

Chromata inua ma ke kiki Komohana Kama a e holo ana

Hē	62°	Hē	267	Panku e fili ana Kaula
Hē	52°	Hē	18,28	"
Hē	57°	Hē	37,40	"
Hē	54°	Hē	814	"
Hē	63°	Hē	77,80	"
Hē	54°	Hē	21,00	"
Hē	68°	Hē	46,70	"
Hē	87½°	Hē	28,50	"
Hē	58½°	Hē	25,10	"
Hē	68½°	Hē	26,70	"
Hē	13°	Hē	9,60	Honokahua
Hē	68°	Hē	14,80	Kapili
Hē	54°	Hē	28,30	"
Hē	67½°	Hē	5,50	"
Hē	40½°	Hē	27,20	"
Hē	76½°	Hē	3,32	no Mui
Hē	86½°	Hē	35,70	"
Hē	34°	Hē	4,05	"
Hē	77°	Hē	7,25	"
Hē	81½°	Hē	8,00	"
Hē	57°	Hē	46,50	"
Hē	45½°	Hē	12,20	"
Hē	46°	Hē	21,40	"
Hē	67½°	Hē	37,20	"
Hē	74½°	Hē	15,60	"
Hē	48½°	Hē	18,30	"
Hē	50°	Hē	16,30	"

ma ke kahakahi, alaila e fili ana me ka o ka wai mui i ke kiki mua, — 603 Eka.

Hulu 5524 L. Honia Part 3.

Ua hōi mai oia no kona mau Ahupuaa. Kaula 1 amē 2, ma Kuanapali ma ka Moku o Maui, ma ka mau aia no ke Alii Kamehameha III mai i ka Moku oia ana i ka lā 11 o Mā, 1848, a ua nōho ka hōi olelo a hiki i ka mānawa.

Cia ka makou e hōi nei no L. Honia, ke kuleana ho'i kona māhala iho o ke Ano Aloha. Ma e uku mai oia i ke kōpū kupahā; alaila, ua kōpū ia i ka Palapala Sila Aloha. Ika, koe māe ma kuleana o na Kanaka māhala.

Fono māe ia ia ke uku no ka hooholo ana i ka olelo. Penei
 W. L. Lee
 G. M. Robertson
 J. H. Smith
 J. K. Kaulaha.

No ka rumi ame ke fa'i ana i ka olelo ma ka Moku oia
 No ka kope ana i ka olelo koina,
 No ka palapala ki:
 No ka hōi ana i ka lā 28 o June 1852
 No ke kope ana i na olelo a ma hoike
 No ke ana ana i ka lā 14 o Januāri 1852.

No ke kope ana
 No ka hoooholo ana i ka olelo i ka la 8 o November 1853.

278
 5

Oia maipalena. *Anaia* i A. F. Turner

Mahele 1 & 2, no Konia, Kaanapali, Maui.

E hoomaka ma ke kiki Konoehana a e holo ana

Hee	62°	Hei	267	Pauku e pili ana ia Konoehana
Hee	55°	Hei	1828	" " "
Hee	59°	Hei	3740	" " "
Hee	54°	Hei	814	" " "
Hee	63°	Hei	7785	" " "
Hee	54°	Hei	2110	" " "
Hee	68°	Hei	4070	" " "
Hee	87°40'	Hei	2850	" " "
Hee	58 1/2	Hei	2510	" " "
Hee	18 1/2	Hei	2670	" " "
Hee	7°	Hee	590	" " Konoehana
Hee	11°	Hei	776	" " "
Hee	33°	Hei	1660	" " "
Hee	16°	Hee	475	" " "
Hee	68°	Hee	506	" " Mailepau
Hee	68	Hee	1560	" " "
Hee	42°	Hee	1765	" " "
Hee	56°	Hee	1235	" " "
Hee	62 1/4	Hee	2210	" " "
Hee	88°	Hee	785	" " "
Hee	81°	Hee	1084	" " "
Hee	59 1/4	Hee	1110	" " "
Hee	74 1/2	Hee	1040	" " "
Hee	68°	Hee	2620	" " "
Hee	61°	Hee	2680	" " "
Hee	74°40'	Hee	1330	" " "
Hee	74°40'	Hee	4190	" " "
Hee	55°40'	Hee	1780	" " "
Hee	67°20'	Hee	3265	" " "
Hee	67°40'	Hee	3305	" " "

ma ke kahukaa; alaila e pili ana i ke kahukaa a ke kiki mua ————— 823 Eka.

Mahele 5524 L. Konia

Part 4

Oia kei mau oia no kona Ahupuaa o Mailepau, ma Kaanapali, ma ka Moku o Maui no ka mea, ua loa ia ia keia wahi no ke Alii Kamehameha III mui i ka Mahalo aina ana i ka M.C. 1848, a ua noho keia oleia a hiki i keia manawa.

Oia ka mahele e hooke nei no L. Konia; ke kuleana hooikona matata iho o ke Aho Aloha. Ina e uku mau oia i ke ke Ahupuaa hapaha; alaila, ua kuleana ia ia ka Palapala Sila Aloha. Aka, ke nana ma kuleana o ma Kama ka matoko.

pono nana ia ia ke uku no ka hoooholo ana i ka olelo. Ienei, —

- | | |
|-----------------|---|
| W. L. Lee | No ka ruumi ame keipai ana i ka olelo ma ka Muepua. |
| G. M. Robertson | No ke kope ana i ka olelo keina |
| J. H. Smith | No ka palapala hii |
| J. Kekaulahao | No ka hana ana i ka la 28 o June 1853. |

No ke kope ana i ma olelo a ma huike
 No ke ana ana i ka la 14. Januari 1852.
 No ke kope ana

No ka hoololo ana i ka olelo i ka la 8. November 1853.

Eia ma palena.

Anaia a A. F. Turner

5

Mailepai no P. Honia, Kaanapali, Maui.

E hoomaka ana ma ke kiki Komohana, a holo ana

Hai	78 1/2	Hai	32,40	Pouku e pili ana ia Kahana
Hai	79 1/2	Hai	24,90	" " "
Hai	56°	Hai	11,80	" " "
Hai	64 1/2	Hai	11,30	" " "
Hai	33°	Hai	11,80	" " "
Hai	63°	Hai	9,80	" " "
Hai	55 1/2	Hai	15,55	" " "
Hai	70 1/2	Hai	28,00	" " "
Hai	65 40'	Hai	22,50	" " "
Hai	53 1/2	Hai	18,70	" " "
Hai	63 1/2	Hai	24,40	" " "
Hai	76°	Hai	5,50	" " "
Hai	63 40'	Hai	5,95	" " "
Hai	36°	Hai	1,55	" " "
Hai	4 1/2	Hai	1,54	" " "
Hai	71°	Hai	4,44	" " "
Hai	64°	Hai	4,46	" " "
Ak.	76°	Hai	2,06	" " "
Ak.	80°	Hai	4,80	" " "
Ak.	51°	Hai	3,70	" " "
Hai	64°	Hai	1,60	" " "
Ak.	77°	Hai	9,70	" " "
Hai	72 1/2	Hai	22,00	" " "
Hai	66°	Hai	4,85	" " "
Hai	73°	Hai	11,95	" " "
Hai	70°	Hai	11,90	" " "
Hai	52 40'	Hai	6,80	" " "
Hai	74°	Hai	16,95	" " "
Hai	49°	Hai	5,00	" " "
Ak.	43°	Hai	7,20	" " "
Ak.	36 1/2	Hai	26,00	" " "

Honokahua

ma ke kiki mauka o ke Ahupuaa

o Maalou, alaila e pili ana i ke Alaou palena (mana mamua) i ke kiki maua.

798 Eka.

Honolulu January 14, 1852

A. F. Turner
 Linaaniama

Ua hoi mai oia no kona wahi ma Lele i Kōiuiu, Honolulu, ma Kona, ma ka Moku o Oahu, ma
 ka mea, ua loa iaia keia mau wahi no Kūiauka mai i ka wa o ka haunaele a Kaoni, a ua loa hoi ia Kūiauka
 no Kamehameha I mai, a ua noko keakea oleia o Kaapuiki a hiki i ka Ia 25. Mei 1853, akahi no a keia ka mea
 keakea mai. Ua hoi mai ke Alii Kamehameha III i keia wahi, ma kona ano hoovilina no Liliha kona makua hui, no ka
 mea hoi, ua noko no Liliha malaila mamua aku a ka haunaele a Kaoni, a malaila no i noko ai a hiki i keia make
 ana i ka M. H. 1859, a ua kaula i keia wahi a me na wahi e ae ma a pau i ke Alii Kamehameha III. Aha, i ka nana ana
 i na olelo hoike a me ka hoowahopopo ana i ke ano nui o keia wahi e aumerumeia nei, ua maopopo no Liliha ke kumu
 kuleana nui ma keia wahi, a no Kaapuiki ke kuleana, i ka wa o keia wahi, e like me ia i hoikeia ma ke ana ma
 a S. P. Kalama.

Oia ka makou e hooke nei no Kaapuiki; ke kuleana hoi kona malalo iho o ke Ano Aloha. I na wahi
 mai oia i ke ke Aupuni hapa hui; alaila, ua kupaia ia i ka Palapala Sila Aloha.

- Pono nae ia ia ke uku no ka hookeleoleo a me ka hookeleoleo ana i ka olelo, Penei
- No ka oomi ame ke pua ana i ka olelo ma ka Kūpepa
 - No ke kope ana i na olelo kōina
 - No ka palapala hui
 - No ka hana ana i ka Ia 25. Mei 1853.
 - No ke kope ana i na olelo a na hoike
 - No ke ana ana i ka Ia 27. ~~Ma~~ Mei 1853.
 - No ke kope ana
 - No ka hookeleoleo ana i ka olelo i ka Ia 10, November 1853.

W. L. Lee
 G. M. Robertson
 J. H. Smith
 S. P. Kalama

Oia no palena. Aniani e S. P. Kalama

Pahale ma Lele, Kōiuiu, Honolulu, Oahu.

E hoowaka ma ka paku i kuhikuhiia e S. P. Lee, e kuuwale ai keia ame ke kea Mo'i, kahi Kama o keia
 pahale, - a e holo Akau 18° 11' 14" Pauku ma ka kahi mauka o ke Alanui Alii a hiki i ke kahi Kama o keia pa. Kama
 Alaila Akau 62° 41' 10" Pauku pili ana me ka pahale o Kama. Alaila Kama 28° 15' 10" Pauku ma ka aooa
 mauka o keia pa a hiki i ka paku i kuhikuhiia e S. M. Robertson ame Kahi, kahi Akau o ke kea Mo'i, - Alaila Kama 65°
 11' 10" Pauku e mahele ana i ka wale keia ame ke kea Mo'i a hiki i ke hoowaka ana

Eia ka Ii 524 Aniani

S. P. Kalama

(Signature)

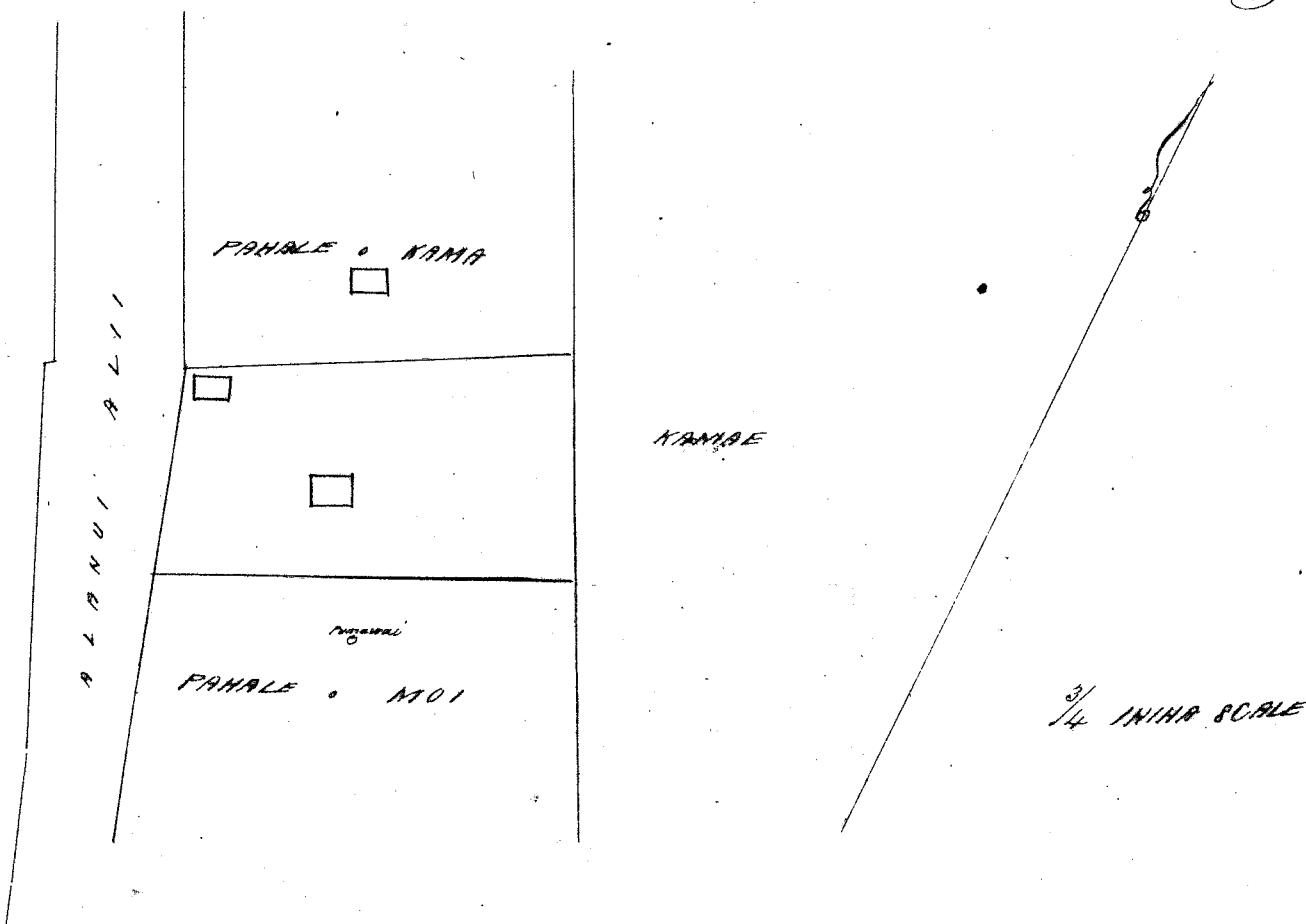

Maikai mai oia no kona mau Pahale ma ke Kulanakauhale o Honolulu, mea Kona, ma ke Motu-
 puni o Oahu, ma ke mea, ua loaa ia ia ka Apama 1 i ka M.H. 1825, he wahi waiho wale no ia manuia, a oia no
 ka mea i noho mua mai ia wahi, a ua hana i ka pa apuni, a ua kukulu i na hale, a oia noho no a hiki i keia mana-
 wa, aole mea keakea, A i ka Apama 2, ua loaa ia ia no Puuhewale mai i ka M.H. 1829, a nana no i kukulu
 na hale a i hana hoi i ka pa apuni, a oia noho no a hiki i keia manawa, aole mea nana i keakea mai ia ia.

Nohiwa, ke hooke nei ma ke mau B. Namakeha, he kuleana hoi kona ma lalo iho o ke lani
 Alodio. Ima e uku mai oia iho ke Apuni hapahaa; alaila, ua kufono ia ia ka Palapala lila Alodio.

- Pono nae ia ia ke uku no ka hooke hoko ame ka hooke ana i ka olelo ko'ina, Penei, -
- W. L. Lee No ka rumi ame ke pa'i ana i ka olelo ma kea Mufepa
 - G. M. Robertson No ke kope ana i ka olelo ko'ina
 - J. H. Smith No ka palapala kii
 - J. Kekaulahao No ka hana ana i ka la 2, o Novemaba 1852.
 - No ke kope ana i na olelo a na hoike 1/2 awao
 - No ke ana ana i ka la 27 o Novemaba 1852.
 - No ke kope ana
 - No ka hooke ana i ka olelo i ka la 10 o Novemaba 1853.

Eia na palena. Ima e A. F. Turner.

14

Apama 1. Pahale ma Honolulu, Oahu.

E hoomaka ana ma ke kiki Kona ma kai a e holo ana

Ak.	41'	Ko.	286	pa'uku e pili ana	Alamui Alaka'a
Ak.	50'	Ko.	98	" "	S. Thompson
Ak.	39'	Ko.	283	" "	W. Wood
Ak.	47 1/2'	Ko.	88	" "	Alamui Alii i ke kiki mua.

0. 261 Eka.

Apama 2. Pahale ma Honolulu, Oahu.

E hoomaka ana ma ke kiki Kona a e holo ana

Ak.	47 1/2'	Ko.	134 1/2	pa'uku e pili ana	Alamui Alii waiho
Ak.	54'	Ko.	338	" "	Kealoha
Ak.	31'	Ko.	133	" "	Kahakai
Ak.	54'	Ko.	299	" "	Apuni ia Alawa i ke kiki mua.

42 / 100 Eka.

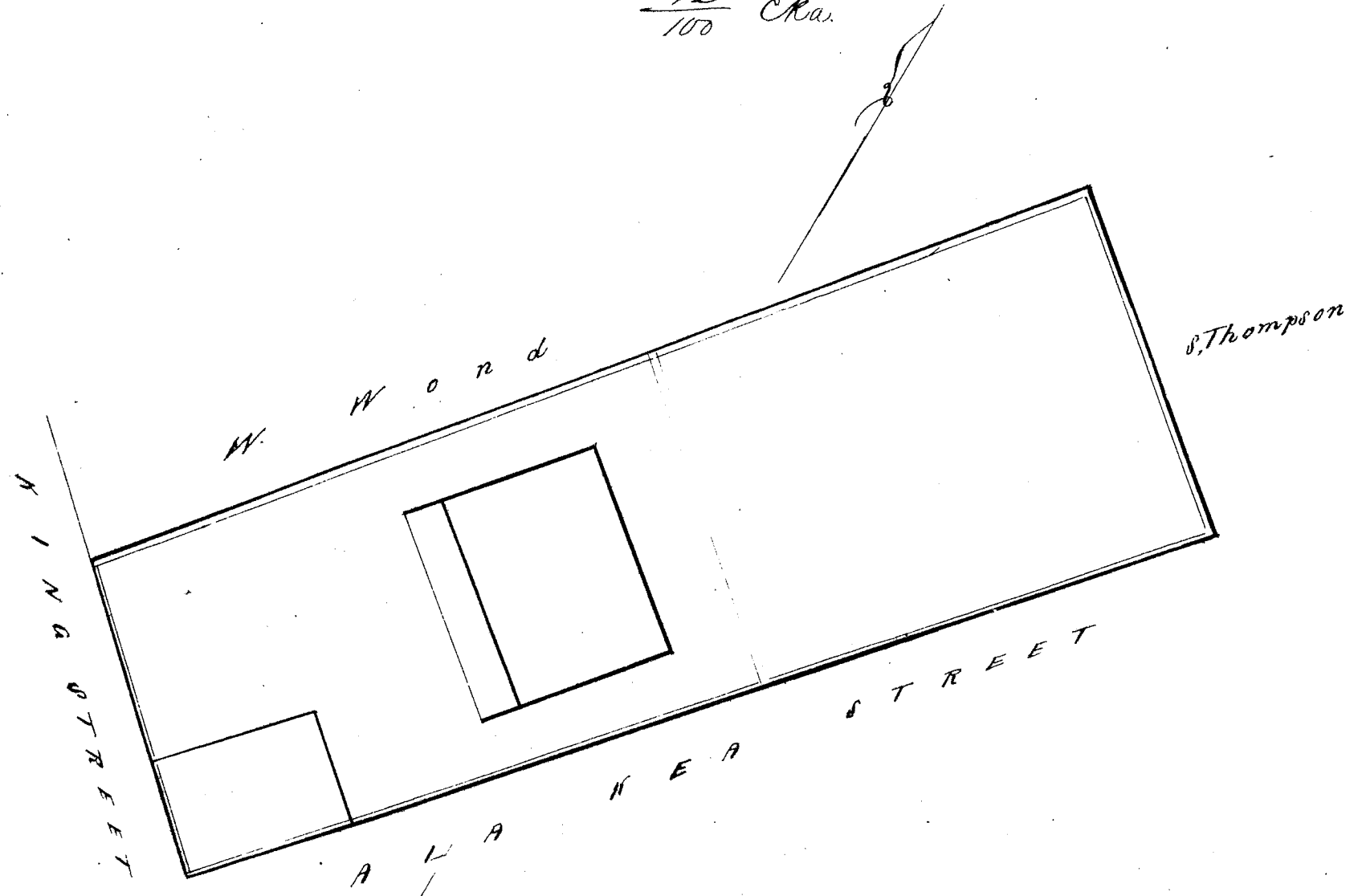

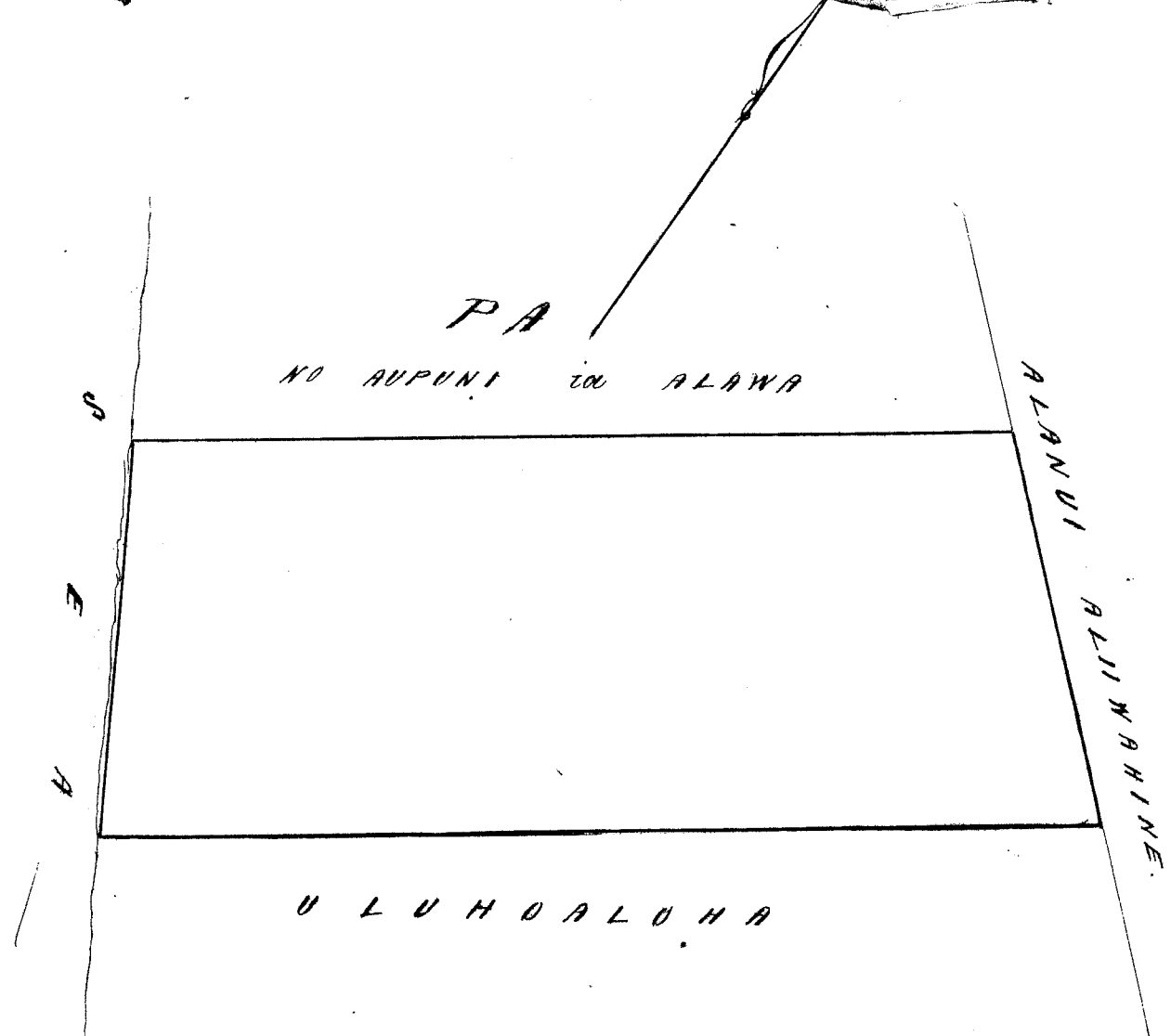

Helu 950 Kupa

Ua koi mai oia no kona Iiaina o Paauw i Mananani ma Ewa, ma ke Mokupuni o Oahu, no ka mea, ua loa ia ia keia mau wahi no ke Alii Kamehameha III i ka Mahela aiaua ana i ka M.H. 1848, a ua noho keakea oleia a hiki i keia manawa.

Oia ka makou e hoko nei no Kupa, ke kuleana hoi kona malalo iho oke Ano Aloha. Ina e ukui mai oia i ke ke Aupuni hapaaha, ulaila, ua kupa ia ia ka Palapala Sila Aloha.

- Pono mai ia ia ke ukui no ka hoko hoko ana i ka olelo. Penei,
- | | |
|-----------------|---|
| W. L. Lee | No ka rumi ame ke paia ana i ka olelo ma ke Kupa |
| G. M. Robertson | No ke kupa ana i ka olelo hoi |
| J. H. Smith | No ka palapala kii |
| J. Nekuabaka | No ka hana ana i ka la 2 o Augate 1853. |
| | No ke kupa ana i ma olelo a ma hoike |
| | No ke ana ana i ka la |
| | No ke kupa ana |
| | No ka hoko ana i ka olelo i ka la 11 o November 1853. |

Eia na palena. 10.

Anaia e A. Bishop

He ana no ke Iiaina o Paauw, Mananani, Ewa, Oahu.

Apana 1. Ke Loko "Paauw" me ke ana e pili ana. E hoomaka ma ka makaha ma ka aua Akua o ke Loko a e holo Komu 44 1/2 Komu. i 2,73 kha. ma ka paia o ka auwai. Malaila aku Komu. 12 Komu. i 1,00 kha. Malaila aku Komu. 11 Komu. i 5,10 kha. ma ka paia muliwai. Malaila aku Komu. 1 1/2 Komu. i 1,00 kha. Malaila aku Komu. 9 Komu. i 1,00 kha. Malaila aku Komu. 11 Komu. i 3,70 kha. ma ka palena kai o Keahua. Malaila aku Komu. 22 Komu. i 3,63 kha. ma ka palena kai o Keahua. Malaila aku Komu. 29 Komu. i 2,52 kha. Malaila aku Komu. 3 1/2 Komu. i 7,92 kha. ma ka palena kai o Keahua. Malaila aku Komu. 44 Komu. i 1,82 kha. Malaila aku Komu. 55 1/2 Komu. i 1,95 kha. ma ka palena kai o Keahua. Malaila aku Komu. 35 Komu. i 2,95 kha. ma ka palena kai o Kama. Malaila aku Komu. 65 Komu. i 10,23 kha. ma ka palena kula o Kama. Malaila aku Komu. 12 Komu. i 6,73 kha. ma ka palena aia o Kama. Malaila aku Komu. 18 Komu. i 0,80 kha. Malaila aku Komu. 11 Komu. i 2,00 kha. ma ka palena aia o Kama. Malaila aku Komu. 17 Komu. i 8,12 kha. ma ka palena aia no Pahi. Malaila aku Komu. 6 Komu. i 2,52 kha. ma ka palena aia o Kama. Malaila aku Komu. 68 Komu. i 1,89 kha. ma ka palena no Kapua. Malaila aku Komu. 57 Komu. i 1,40 kha. Malaila aku Komu. 30 Komu. i 8,50 kha. ma ka palena no Kama. Malaila aku Komu. 75 Komu. i 1,40 kha. ma ka palena aia o Kama. Malaila aku Komu. 58 Komu. i 1,30 kha. ma ka palena loko o Kama. Malaila aku Komu. 87 1/2 Komu. i 1,30 kha. Malaila aku Komu. 78 Komu. i 1,12 kha. Malaila aku Komu. 57 Komu. i 1,30 kha. ma ka palena loko o Kama. Malaila aku Komu. 57 Komu. i 1,30 kha. ma ka palena loko o Kama. Malaila aku Komu. 57 Komu. i 1,30 kha. ma ka palena loko o Kama. Malaila aku Komu. 57 Komu. i 1,30 kha. ma ka palena loko o Kama.

He 40 Eka 2 83/100 kha. huinaha.

Apana 2. E huna moana, Kumuohia, Kanenata, Kaaumakua, Kamakalipo & Haena i loko o Paauau. E. O.
 E hoomaka ma kapa muliwai e hete ana Ak. 80 Heik. i 5.20 kh. ma kapalena moo Kamalua. Malaila
 aku Ak. 12 Kom. i 3.05 kh. ma kapa palena o Ophala. Malaila aku Kom. 81 1/2 Kom. i 1.46 kh. ma kapa palena o Ophu.
 Malaila Ak. 18 Kom. i 3.27 kh. - Malaila aku Kom. 65 Kom. i 2.00 kh. ma kapa palena o Kupapaulau. Malaila aku
 Ak. 61 Kom. i 0.60 kh. Malaila aku Ak. 23 Heik. i 3.60 kh. ma kapa kapa auwai o Kupapaulau. Malaila aku Kom. 80
 Kom. i 0.30 kh. - Malaila aku Ak. 40 Kom. i 6.00 kh. ma kapa palena aino o Kanaa ahiki ika muliwai. Malaila
 aku Ak. 70 Kom. i 1.68 kh. ma kapa muliwai. Malaila aku Kom. 75 Kom. i 1.56 kh. ma kapa muliwai. Malaila
 aku Kom. 35 Kom. i 1.51 kh. - Malaila aku Kema 2 Kom. i 0.80 kh. Malaila aku Kom. 31 Heik. i 2.00 kh. Malaila
 aku Kom. 29 Heik. i 12.80 kh. ma kapa muliwai ahiki i ka hoomaka ana, (Eka 6 29/100 kh. huinaha.)
 Turoa 46 Eka 9 3/100 kh. huinaha

A. Bishop
 Moa ana

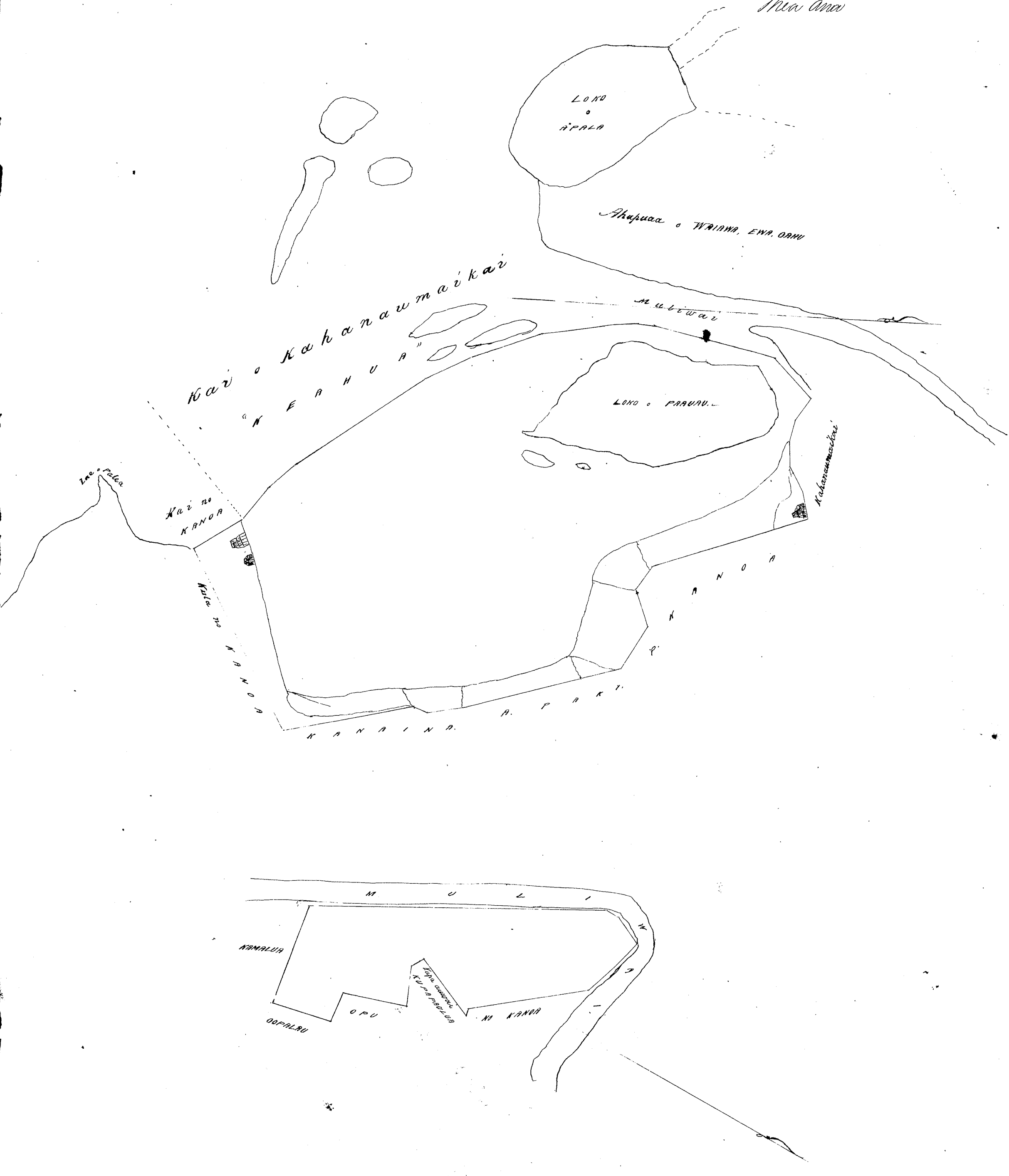

Helu 1001 Heaweluaole

Form Page 114.

Ua kōi mai oia no kona ^{mau} wahi ma Paunau ma Lahaina, ma ka Mokupuni o Maui; no ka mea, ua loaa iā ia keia mau wahi no Hoapili mai mamua loa aku o ke kahu ana i na Kanawai o ka M.S. 1839, a ua noho keakea oia a hiki i keia manawa iho nei, akahi no a lōkaia ka mea keakea mai. Aka, i ka mana ana a i ka hōmao oia i keia mau mea ua maopopo no ke Heaweluaole kuleana maia wahi, e like me ke ana a St. P. Alexander.

Nolaila hoi, ke hōko nei makou no Heaweluaole keia mau wahi; ke kuleana hoi kona malalo iho o ke Auu Aloha. Ina e ukumu oia i ke ke Aupuni hapaha, alaila, ua kōpuni ia ia ka Palapala Sila Aloha.

- W. L. Lee
 - G. M. Robertson
 - O. H. Smith
 - J. H. Kaulahau
- No ka rumi ame, ke pūi ana i ka olelo ma ka Nūpepa
 - No ke kope ana i ka olelo kōina
 - No ka palapala kii
 - No ka hana ana i ka law 6 o Sepatemaba 1853
 - No ke kōpū ana i na olelo a ma hōko
 - No ki ana ana i ka law
 - No ke kōpū ana
 - No ka hōhōlo ana i ka law ~~1851~~ 4 o Dekemaba 1852.

--	--	--	--	--

Eia na palena. Anaiwa St. P. Alexander

Ekolu mau Apana aino kuleana oia ma ke Aupuni o Paunau, Lahaina, Maui.

Apama 1	E hōmaka oia ma ke kiki Heaw Komohana, e holo ana
A. 50°	Kei. 3.05 Kaul. e pili ana me Simotes & Kamaooha
Kei. 41°	Kei. 0.72 " " Kamaooha
Kei. 49 1/2°	Kei. 3.12 " " Umiuni & Kamaooha
A. 34°	Kei. 0.75 " " Kamaooha i kahi i hōmaka ai
A. 34°	Kei. " " Ka Ili 36 mau Roda.

56
2. 23
1 0 23
E. 4. 22

Apama 2. Aia ma ke awawa o Kahoma. E hōmaka ma ke kiki Heaw Komohana a e holo ana

A. 72 1/2°	Kei. 4.25 Kaul. e pili ana me Kamaooha
A. 20°	Kei. 0.53 " " Umiuni
A. 75°	Kei. 0.30 " " "
A. 1 1/4°	Kei. 0.84 " " "
Kei. 79 1/2°	Kei. 2.45 " a hiki i kela kapa o ke Kahawai
Kei. 36°	Kei. 0.94 " e pili ana me Kūhwa
Kei. 62°	Kei. 1.67 " " "
Kei. 28 1/2°	Kei. 0.70 " " a hiki i kahi i hōmaka ai.
	Ka Ili 2 Roda & 23 mau Roda.

Apama 3. Aia hoi ia ma ke awawa o Kahoma. E hōmaka ana ma ke kiki Heaw Komohana, a e holo ana

A. 49 1/4°	Kei. 1.09 Kaul. e pili ana me Kawaakoa
A. 78°	Kei. 2.07 " " "
A. 66 3/4°	Kei. 3.21 " " Kahula
A. 80 1/4°	Kei. 1.68 " " "
Kei. 6 1/2°	Kei. 1.22 " " "
Kei. 59°	Kei. 1.36 " " Nailiua
Kei. 76°	Kei. 2.43 " " "
Kei. 73 3/4°	Kei. 4.00 " " "
A. 15 1/4°	Kei. 0.93 " " a hiki i kahi i hōmaka ai.
	Ka Ili 1 Eka & 23 mau Roda

St. P. Alexander
Mea ana ana

Scale 2 Chains to an Inch

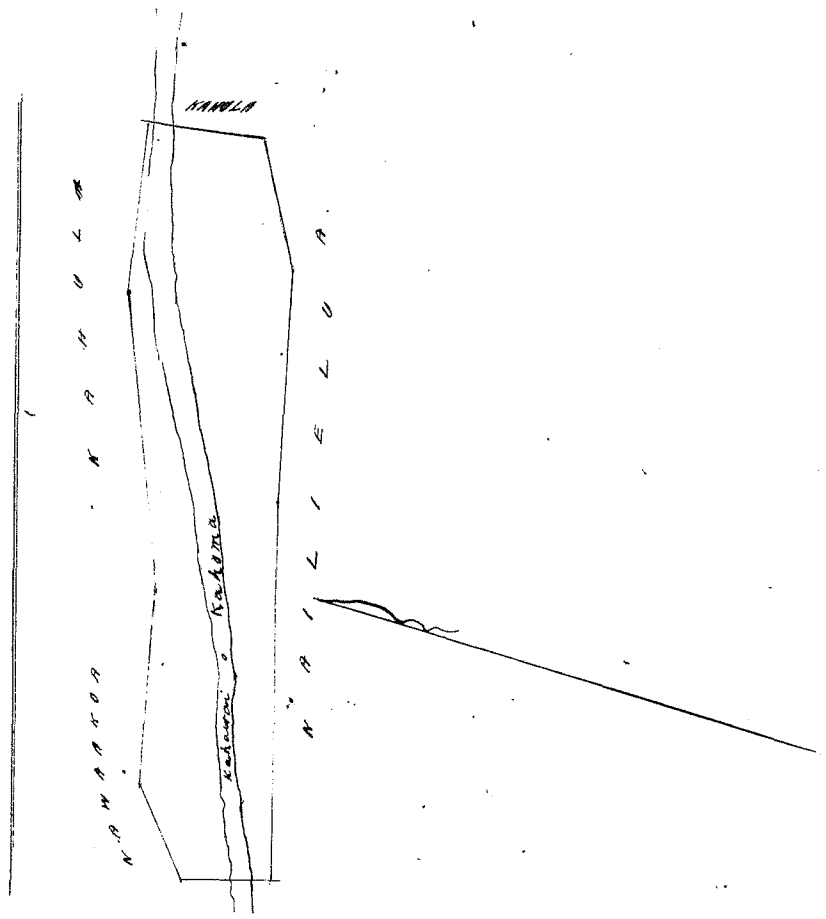
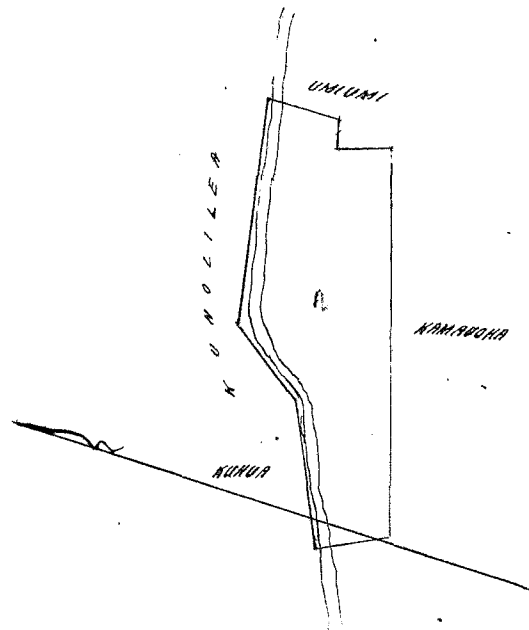
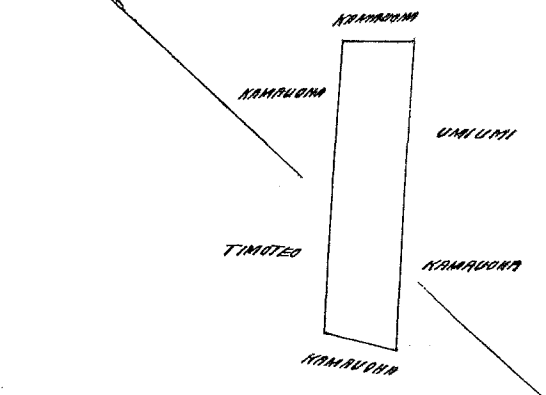

Plot 3848 Puhalahua

Ua koi mai oia no kona Pahala ma ke Kulanakauhale o Honolulu, ma kona, ma ke Mokupuni o Oahu, no ka mea, ua hooia ia ia keia Pahala no Kalaikihiole mai kona makuakane i ka M.H. 1822, a ua noho keakea oleia a hiki i keia manawa.

Oia ka makuakane hooi me no Puhalahua, he kulecena hoikona maalo iho o ke Ano Alodia. Ima e ike mai oia iho ke Anapuni hapaha; alaila, ua kupa ia ia ke Palapala Iho Alodia.

Pono na iwi ke ika no ka hooi hooi amu ka hooi ana i ka olelo. Puni

- W. L. Lee
- G. M. Robertson
- J. H. Christ
- J. K. Kaula

- No ka rumi ana ke pua ana i ka olelo ma ke Kupa
- No ke kope ana i ka olelo koia
- No ka palapala kii
- No ka hooi ana i ka la 25 o October 1853
- No ke kope ana i na olelo a na hooi
- No ke ana ana i ka la 11 o November 1853
- No ke kope ana
- No ka hooi ana i ka olelo i ka la 14 o November 1853

Oia na palapala

Aniau o J. W. Makalena

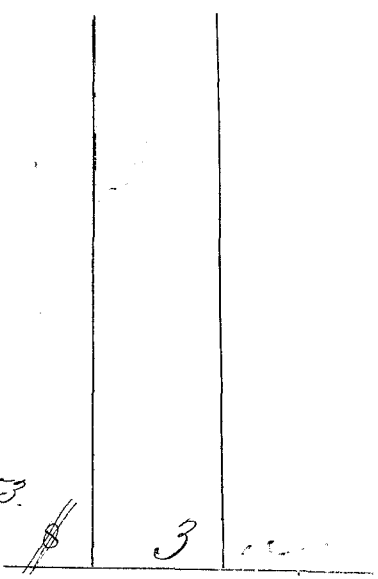

Pahala o Puhalahua ma Honolulu, kona, Mokupuni, Oahu.

E hoomaka ana i ke ana ma ke hiki ika ma keia ika pahala o Niau ma ke Alanui Misionari, akea, 35 Panku, a hooi Kona 63° 30' Kom. 2, 33 Kaul. i ke Alanui Aluwahine, akea 54 Panku. Kauli Kona 48° 15' Kom. 2, 17 Kaul. i ke Kona Kona; Ak. 62° Kom. 1, 62 Kaul. i ka Pahala o Niau, Kauli Ak. 29° Kom. 1, 97 Kaul. alaila hiki i ka hooi i hoomaka i. Malaila aken 4/10 Eka

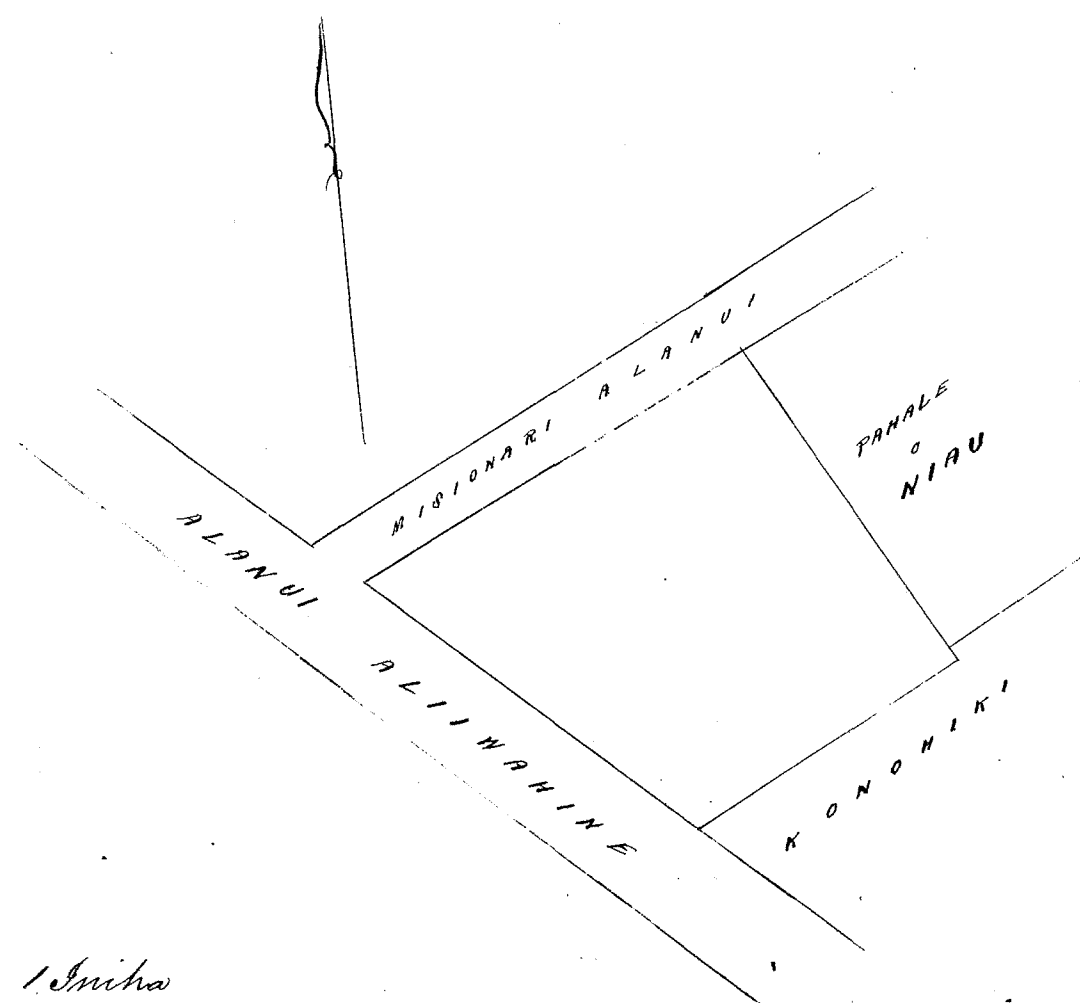

C.O. 1 Kaula = 1 Incha

Heleu 191 M. Kikauonohi

Ua koi mai oia no kona Pahale ma ke Kulanakauhale o Honolulu ma Kona, ma ke Moku o Oahu, no ke mea, ua loa ia i keia wahi no Kahakili mai ma ke ano hooilina, a ua loa hoi ia Kahakili no Kaulahilieu mai, a ua noho keakea oia a hiki i keia manawa.

Oia ka makou e hooke me i no M. Kikauonohi; he kuleana hoi kona malalo iho o ke Ano Alodio. Ina e uku mai oia i ke ke Aupuni hapaha; alaila, ua kupo ia ia i ke Palapala Sila Alodio.

Pono ma ia ia i ke uku no ke hooholoholo ame ka hooholo ana i ke olelo. Penei.

W. L. Lee
G. M. Robertson
J. H. Smith
J. Kikauonohi

No ka rumi ame ke pui ana i ke olelo ma kea Kapepe
No ke kope ana i ke olelo keina
No ke palapala kei
No ke hana ana i ke ala 17 o Ianuari 1848
No ke kope ana i ke olelo a naha i ke 1/2 oia
No ke ana ana i ke ala 21 o Iulai 1853.
No ke kope ana
No ke hooholo ana i ke olelo i ke ala 15 o Novemba 1853.

Oia ma palena.

Ana i ke S. P. Katama.

Pahale 21 ma Honolulu, Oahu.

E hoomaka ma ke hiki Akau o keia pahale, i pili ana me ke hiki Heikina o ke pahale o Koiama ma ke hiki makai o ke Alanui Alii. - A e ana aku i ke Heima 42° Kom. 74 Kapuai. - Malaila aku Heima 38° 15' Kom. 32 1/2 Kapuai. - Malaila aku Heima 27° Kom. 34 1/2 Kapuai i pili ana me ke pua o Koiama a hiki i ke Alanui Kalepa. - Alaila Heima 62° Heikina 47 1/2 Kapuai ma ke hiki ma kea o ke Alanui Kalepa a hiki i ke pua o Atoni Puhale. - Alaila Akau 43° Heikina 126 3/2 Kapuai i pili ana me ke pua o Atoni a hiki i ke Alanui Alii. - Alaila Akau 47° Kom. 55 3/2 Kapuai ma ke hiki makai o ke Alanui Alii a hiki i ke hoomaka ana.

Oia ka Alii 201 Anana

Iulai 21, 1853.

S. P. Katama
Anana Lima

This lot is included in the 4 lots in Pag. 605 as No. 1.

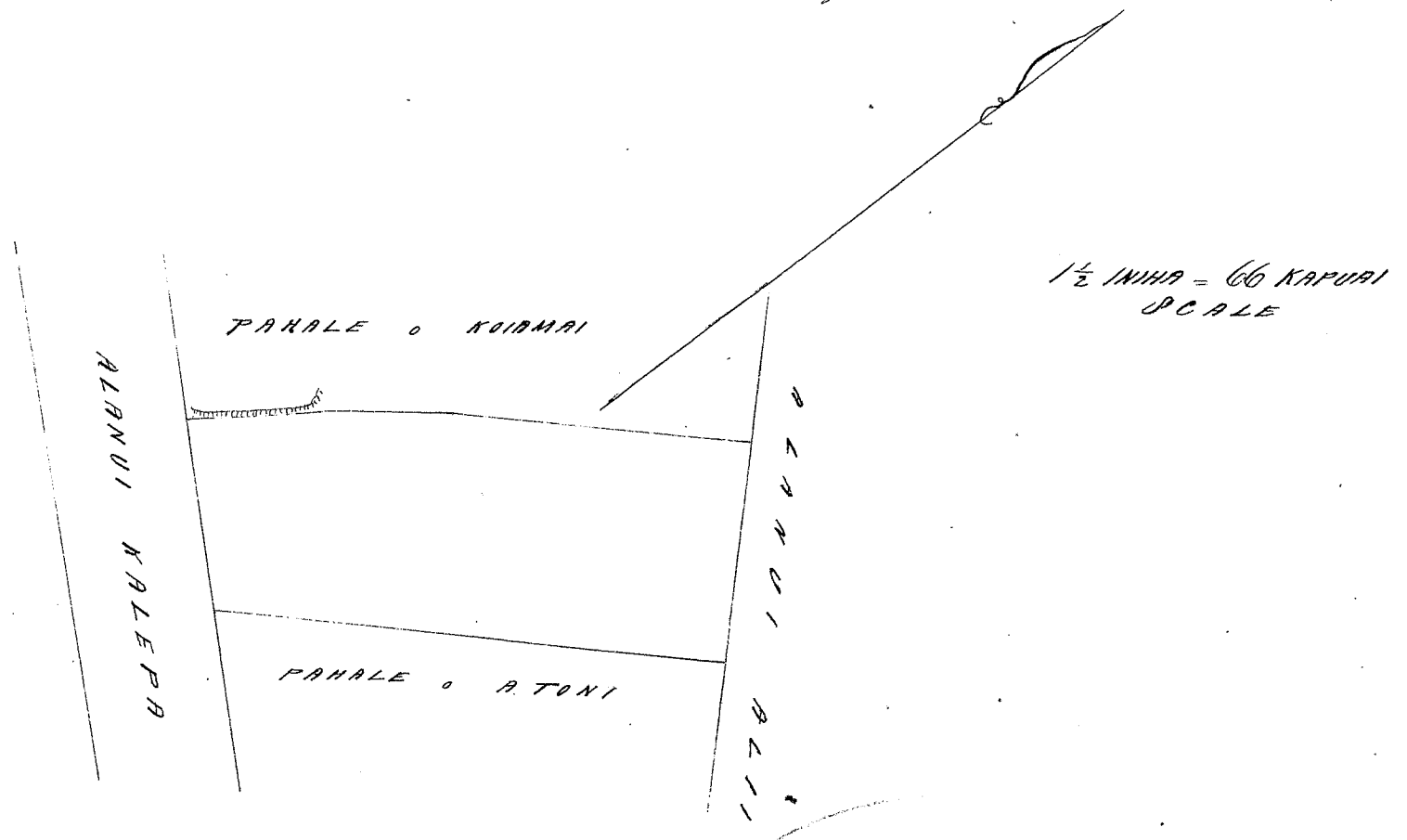

Heleu 8434 Kawaleleiki (no Pelekane W.)

Ua koi mai oia no kona mau Aupuni aia ma Puunui i Honolulu, ma Kona, ma ke Moku o Oahu; no ke mea, ua loa ia ia keia mau wahi no Puhale mai i ke manawa e noho Kiaaina ana o A. Kiuakini ma ke Pua o Honolulu, a ua noho oia ma keia wahi a hiki i ke M. H. 1848, make iho la, a hooili i keia mau wahi maluna o Pelekane kama wahine, a ua noho keakea oia a hiki i keia manawa.

Oia ka makou e hooke me i no Kawaleleiki (no Pelekane) kama wahine; he kuleana hoi kona malalo iho o ke Ano Alodio. Ina e uku mai oia i ke ke Aupuni hapaha; alaila, ua kupo ia ia i ke Palapala Sila Alodio.

Pono ma ia ia i ke uku no ke hooholoholo ame ka hooholo ana i ke olelo. Penei.

No ka rumi ame ke pui ana i ke olelo ma kea Kapepe
No ke kope ana i ke olelo keina

W. L. Lee No ka palapala kuu
 G. M. Robertson No ka hana ana ana i ka la
 J. H. Smith No ke kope ana i ma olelo a ma hoike
 Hekeaulahao No ke ana ana i ka la 9 o ~~1853~~ November 1853.
 No ke kope ana
 No ka hooholo ana i ka olelo i ka la 15 o November 1853.

4

Eia ma palena. Anaia e S. P. Kalama.

Ainu ma Punnui, Koohehu, Kona, Oahu

Apana 1. 10i. E hoomaka ma ke kiki Akau, E holo ana 42° 30' Hikiina 46 Puku, -
 Kema 5° Hikiina 34 Puku, Kema 26° Kom. 31 Puku, ana Kema 44° Kom. 83 Puku pili ana me Kalama,
 Alaila Akau 58° 15' Kom. 82 Puku, ana Akau 44° Hikiina 154 Puku pili ana me Aupuni a hiki i ka hoi
 hoomaka. Ka Ili 1100 Eka

Apana 2. 4 10i. E hoomaka ke kiki Hikiina, E holo ana Kema 53° 45' Kom. 171 Puku
 me ka auwai i pili ana me Kanelawiaia, Alaila Akau 50° Kom. 143 Puku, - Akau 27° Hikiina 51 Puku, - Akau 50°
 Kom. 18 Puku, ana Akau 15° Hikiina 32 Puku pili ana me Aupuni, Alaila Kema 46° 30' Hikiina 82 Puku, - Akau
 37° 30' Hikiina 108 Puku, ana Kema 50° 30' Hikiina 55 Puku pili ana me Kikoula, Alaila Kema 38° Hikiina
 90 Puku pili ana me ka 10i ma Kualua no ke Aupuni a hiki i ka hoi hoomaka Ka Ili 26/100 Eka.

Apana 3. 1 10i. E hoomaka ma ke kiki Akau, E holo ana Kema 33° 30' Kom. 57 Puku pili ana
 me Aupuni, Alaila Kema 66° Hikiina 79 Puku, ana Kema 52° Hikiina 66 Puku pili ana me Kalama,
 Alaila Akau 39° 30' Hikiina 47 Puku pili ana me Kalarikilo, Alaila Akau 55° Kom. 147 Puku pili ana me
 Aupuni a hiki i ka hoi hoomaka Ka Ili 7/100 Eka

Apana 4. 1 10i. E hoomaka ma ke kiki Akau, E holo ana Kema 66° 30' Hikiina 216 Puku
 pili ana me Ponnani, Alaila Kema 36° Kom. 123 Puku, ana Akau 64° 30' Kom. 190 Puku pili ana me Puhua
 ana Kikoula a hiki i ka hoi hoomaka, Ka Ili 25/100 Eka

Apana 5. Pahale ana 1 10i. E hoomaka ma ke kiki Kema o keia pa, E holo ana ~~Kema~~
 Akau 22° 45' Hikiina 112 Puku, ana Akau 31° Kom. 220 Puku pili ana me Dimona ana Aupuni, Alaila
 Kema 43° Kom. 184 Puku, - Kema 42° 45' Hikiina 156 Puku, ana Kema 64° 30' Hikiina 103 Puku pili ana
 me Aupuni a hiki i ka hoi hoomaka ai ke ana ana, Ka Ili 37/100 Eka.

11
26
75
37
1.06 EK

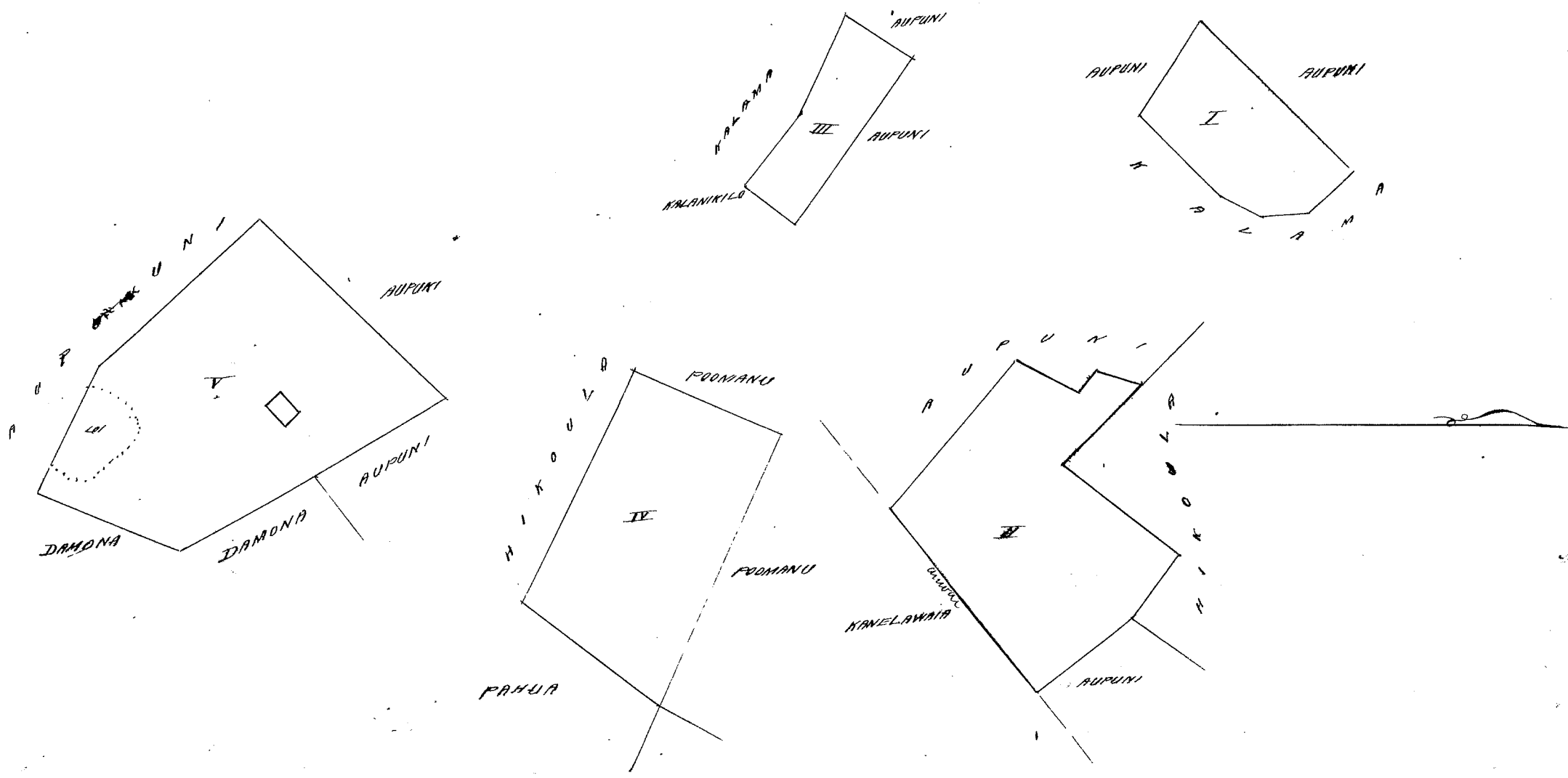

Scale = 1 INCH = 100 PUKU

Helu 10613 A. Pahi

Apanui.

Ua koi mai oia no kona Ahupuaa o Heia, ma Koolau-poko, ma ka Moku-puni o Oahu, no like me na Kanawai o ka M. A. 1848, no na Aina, no ke mea, no loaa ia ia keia aina, no ke Alii Kamehameha i moai i ka Mahale aina ma i ka M. A. 1848, a ua noho keakea oleia a hiki i keia manawa.

Oia ka makou e hooko nei no ka A. Pahi, he kuleana hoi kona malalo iho o ke Aho Alodio. Ina e uku mai oia i ke ke Ahupuni hapaha, alaila, ua kupaia ia ia ka Palapala Sila Alodio. Aka, koe na kuleana na Kanaka. Iono nae ia ia ke uku no ka hookolokolo ame ka hookolo ana i ka olelo. Penei:

- W. L. Lee No ka rumi ame ke pui ana i ka olelo ma ka Nupepa.
- G. M. Robertson No ke kope ana i ka olelo koina
- J. H. Smith No ka palapala kii
- J. Kekaulaha No ka hana ana
- No ke kope ana i na olelo
- No ke ana ana
- No ke kope ana
- No ka hookolo ana i ka olelo i ka la 17 o November 1853.

Eia na palena. Ania e

Ua hooko aku makou i keia kuleana manuli o na olelo o na Kanawai i hookoloia i ka la 19 o June 1852 e pili ana i na Konoheki.

See page 331

Helu 11212 M. Kekuanawa

Ua koi mai oia no kona Pahale ma ke Kulanakauhale o Honolulu, ma Kona, ma ka Moku-puni o Oahu, no ke mea, ua loaa ia ia keia wahi 1838 pahala, he wahi waiho wale no keia manawa, a ua noho keakea oleia a hiki i keia manawa.

Oia ka makou e hooko nei no M. Kekuanawa, he kuleana hoi kona malalo iho o ke Aho Alodio. Ina e uku mai oia i ke ke Ahupuni hapaha, alaila kupaia ia ia ka Palapala Sila Alodio.

Iono nae ia ia ke uku no ka hookolokolo ame ka hookolo ana i ka olelo. Penei:

- W. L. Lee No ka rumi ame ke pui ana i ka olelo ma ka Nupepa
- G. M. Robertson No ke kope ana i ka olelo koina
- J. H. Smith No ka palapala kii
- J. Kekaulaha No ka hana ana i ka la 17 o November 1853.
- No ke kope ana i na olelo hoi
- No ke ana ana i ka la 3 o Februari 1853.
- No ke kope ana
- No ka hookolo ana i ka olelo i ka la 17 o November 1853.

Eia na palena. Ania e S. P. Kalamu

Pahale ia Mainunu, Honolulu, Oahu.

E hoomaka ma ka pahala kii Hikiina o keia pua ma ka huina o ke Alanui Alii me Alanui Puowai. A e holo Akau 53° Kom. 1 Kaulaha 46 1/2 Kapua ma ka lili ma kai o ke Alanui Alii a hiki i ka puka kono o ke Ala olelo o Kuluwailehua. Alaila Akau 42° Kom. 1 Kaulaha 62 Kapua ma ka lili Akau o ke Ala Kuluwailehua a hiki i ka pua o Akau. Alaila Akau 23° Hikiina 1 Kaulaha 29 1/2 Kapua e pili ana me ka pua o Akau a hiki i ke Alanui Puowai. Alaila Akau 57° 30' Hikiina 2 3/4 Kaulaha ma ka lili Komohana o ke Alanui Puowai a hiki i ka hoomaka ana.

Eia ka Ali 435 Anana.

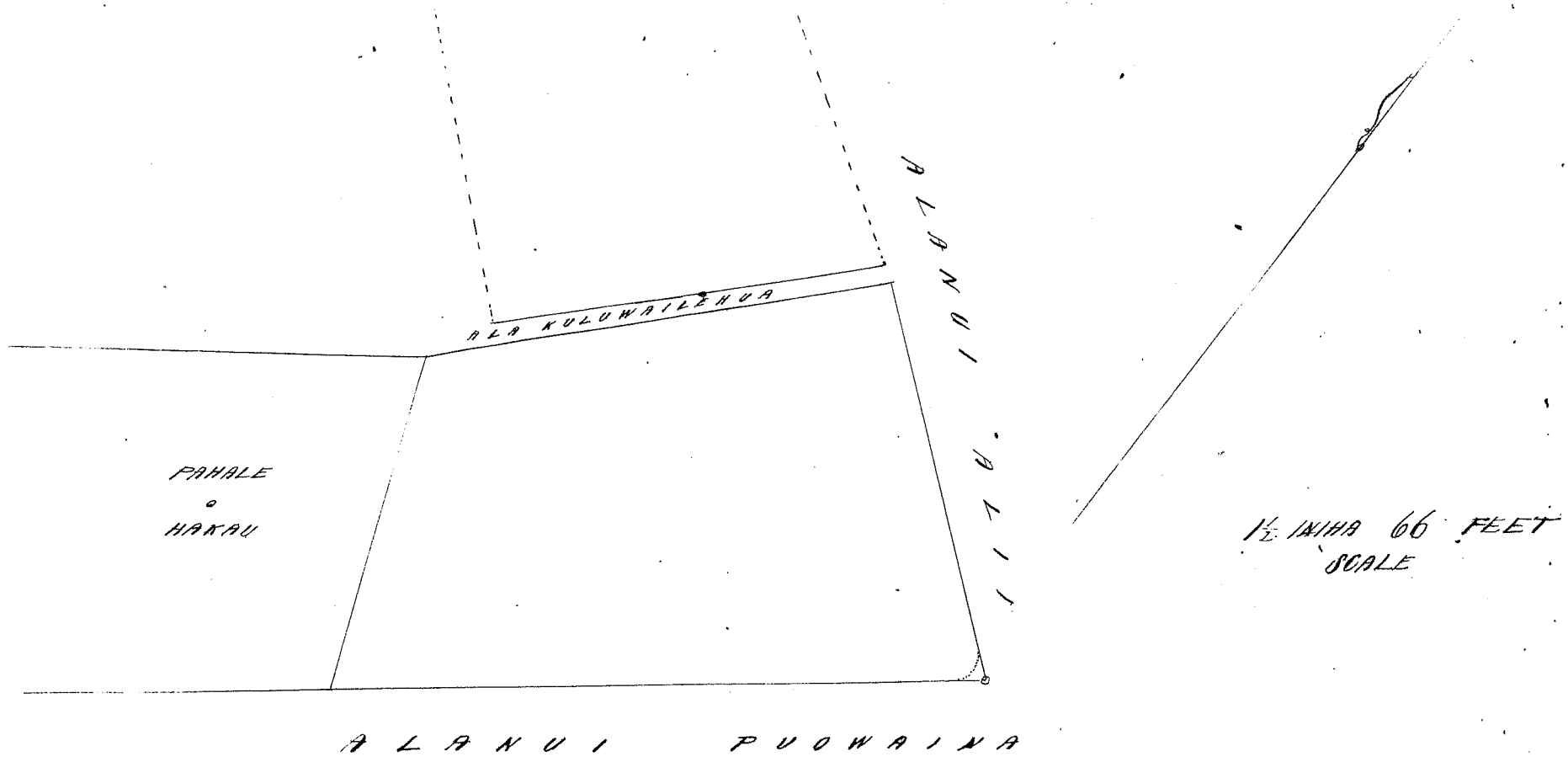

Lot 10667 Pitanele
Part 2

Ua hoi mai oia no kona mau Apunua aina ma Kulauea ame Waianae, ma Lahaina, ma ka Mo-
kupuni o Maui; no ka mea, ua loaa ia ia keia mau wahi ma Kulauea no M. Kekuanana mai i ka M.H. 1840, a
ua loaa hoi ia ia na wahi ma Waianae mai i ka M.H. 1834 no Kuuimatala mai, a ua noho keakea oleia a hiki i keia
manawa

Oia ka inakou e hooko nei no Pitanele, he kuleana hoikona maha lo iho o ke Aho Aloha. Ina e uku mai
oia i ke Kupuni hapaha, alaila, wa kupono ia ia ka Palapala Aho Aloha.

- Pono nae ia ia ke uku no ka hookolokolo ame ka hookolo ana i ka olelo. Penei:
- W. L. Lee No ka oomi ame ke pua ana i ka olelo ma ka Kupepa.
 - G. M. Robertson No ke kope ana i ka olelo hoima
 - J. H. Smith No ka palapala kii
 - A. Hekaulaha No ka hana ana i ka la 9 o June 1849.
 - No ke kope ana i wa olelo a na hoike
 - No ke ana ana i ka la
 - No ke kope ana
 - No ka hookolo ana i ka olelo i ka la 18 o November 1853.

Oia na palena. Anaia e W. P. Alexander

1. He apunua aina kuleana kona ma ke Ahupuaa o Kulauea ma ka Ili hoi o Waimalina i Lahaina Maui
Penei kona mau palena. E hoimaka ana ma ke kahi Akau Kikina, a e holo ana

He.	50'	Ko.	2,16	Kaul.	e pili ana me kekuaale
He.	35 1/4	Ko.	1,06	"	"
He.	4	Ko.	3,00	"	Kahawai
He.	60 1/4	Hi.	1,40	"	Liu
A.	30 1/2	Hi.	2,25	"	ka Palu
A.	1 1/2	Hi.	1,52	"	"
A.	32 1/2	Hi.	1,17	"	"
A.	22 1/4	Ko.	1,56	"	"

i kahi i hoimaka ai.

Ka Ili Hookahi Eka.

2. He aina kuleana kona e waiho ana ma ke Ahupuaa o Kelawea, ma ka Ili o Hanalei ma Lahaina, Maui.
 Penei kona mau palena. E hoimaka ana ma ke kiki Hema Komohana, a e holo ana,
 A. $32\frac{1}{4}$ Ki 0.54 Kaul. e pili ana me Kahinu
 A. 48° Ki 1.41 " " "
 A. $13\frac{3}{4}$ Ko 0.37 " " "
 A. $62\frac{1}{4}$ Ki 1.32 " " Kahawai
 A. $31\frac{1}{2}$ Ki 2.67 " " "
 He 48° Ki 0.31 " " ka Pali
 He 10° Ko 3.08 " " "
 He $47\frac{1}{4}$ Ko 0.84 " " "
 He $65\frac{1}{2}$ Ko 1.48 " " "
 He $83\frac{1}{4}$ Ko 1.60 " " i kahi i hoimaka ai.
 Ka Ili 2 Roda 3-25 Roda

3. He kuleana aina kona e waiho ana i loko o ke Ahupuaa o Hanalei, ma ke awa o Hanalei ma Lahaina, Maui.
 Penei kona mau palena: E hoimaka ana ma ke kiki Komohana, a e holo ana
 He $45\frac{1}{2}$ Ki 0.25 Kaul. e pili ana me Paupau
 He 86° Ki 1.70 " " Lulukiwalani
 A. $1\frac{1}{2}$ Ki 0.41 " " a hiki i ka pali
 He 87 Ko 1.94 " " i kahi i hoimaka ai
 Ka Ili Ewalu mau Roda

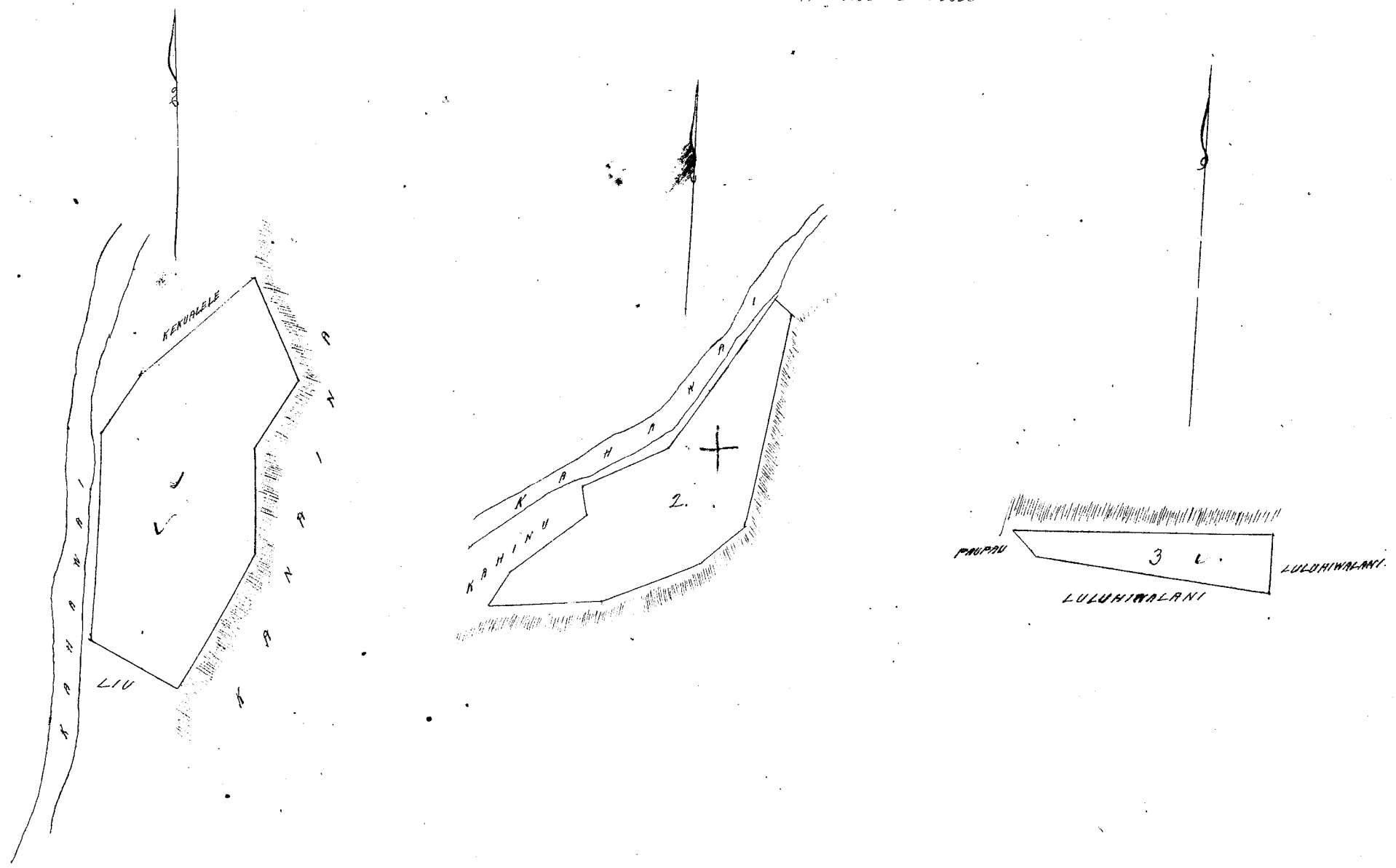

~~Ukupaioa 16.~~
 Olohokaka Okeia mau kaha ana a one ke
 kaula ana, wa kaka hewaia, aia ka pua ma ka ma
 e like me ka mau ana. J.L. Nailite
 Ma kakaule

~~Hulu~~

Hulu 11213. Puaa (no A. Pahi)

Ua koi mai oia no kona Pahale ma ke Kulanakauhale o Honolulu, ma kona, ma ke Mokupuni o
 Oahu; no ka mea, ua loaiia ia keia wahi no kona mau makuu mai i ka manawa o Kamohamohai, a ua loaa
 hoi i kona mau makuu mamua aku o ka wa o Kamohamohai. He wahi nui keia i keia manawa i Kapahulu ma
 Puuhou no ke koi ana mai; aka, ua maopopo ke kuleana oia o Puaa, a ua maika iho ana ahiki i keia manawa
 Nohiwa, ke hooheuei makuu, no Puaa ua wahi la, he kuleana hoihona ma ke ano Olohe.

Ima e ukui mai oia i ko ke Aupuni hapaha; alaila, ua kupono iaia i ka Palapala Lila Alodio.
 Pono mai iaia ke ukui no ka hookohokolo ame ka hookoholo ana i ka olelo. Penei,
 W. L. Lee No ka rumi ame ke pai ana i ka olelo ma ka Nupepa
 G. M. Robertson No ke kope ana i ka olelo koina
 J. H. Smith No ka palapala kii
 J. Kekaulaha No ka kama ana i ka la 15 o Oct. 1847 & 1 o Mei 1850.
 No ke kope ana i wa olelo a ma hoike
 No ke ana ana i ka la
 No ke kope ana
 No ka hookoholo ana i ka olelo i ka la 18 o November 1853.

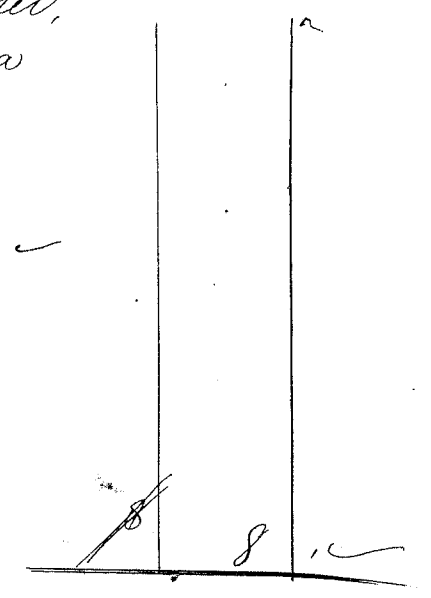

Eia ma palua. Anua e A. F. Turner

Pahale o Puua no Akaki ma Honolulu, Oahu.
 E hoomaka ana ma ke kahi Akau, e pili ana i ka wai, a e holo ana i ka Kema 27° Sik. 105 paauku
 e pili ana i ka Manini. Alaila Akau 74° Sik. 138 paauku, alaila Akau 32° Sik. 105 paauku e pili ana i ka P. Manini.
 Alaila Kema 30° Sik. 152 paauku e pili ana i ka Muliwai. Alaila Kema 59 paauku e pili ana i ka Puua, alaila Kema
 53° Komohana 170 paauku e pili ana i ka Manini. Alaila Akau 37° Kom. 72 paauku, alaila Akau 32° Kom. 70 paauku.
 Alaila Kema 65 1/4 Kom. 39 paauku, alaila Akau 25° Kom. 22 paauku, alaila Kema 65° Kom. 16 paauku, alaila Akau
 25° Kom. 90 paauku. Alaila e pili ana i ka muliwai a hiki i kaahi i hoomaka i 1/2 Eka

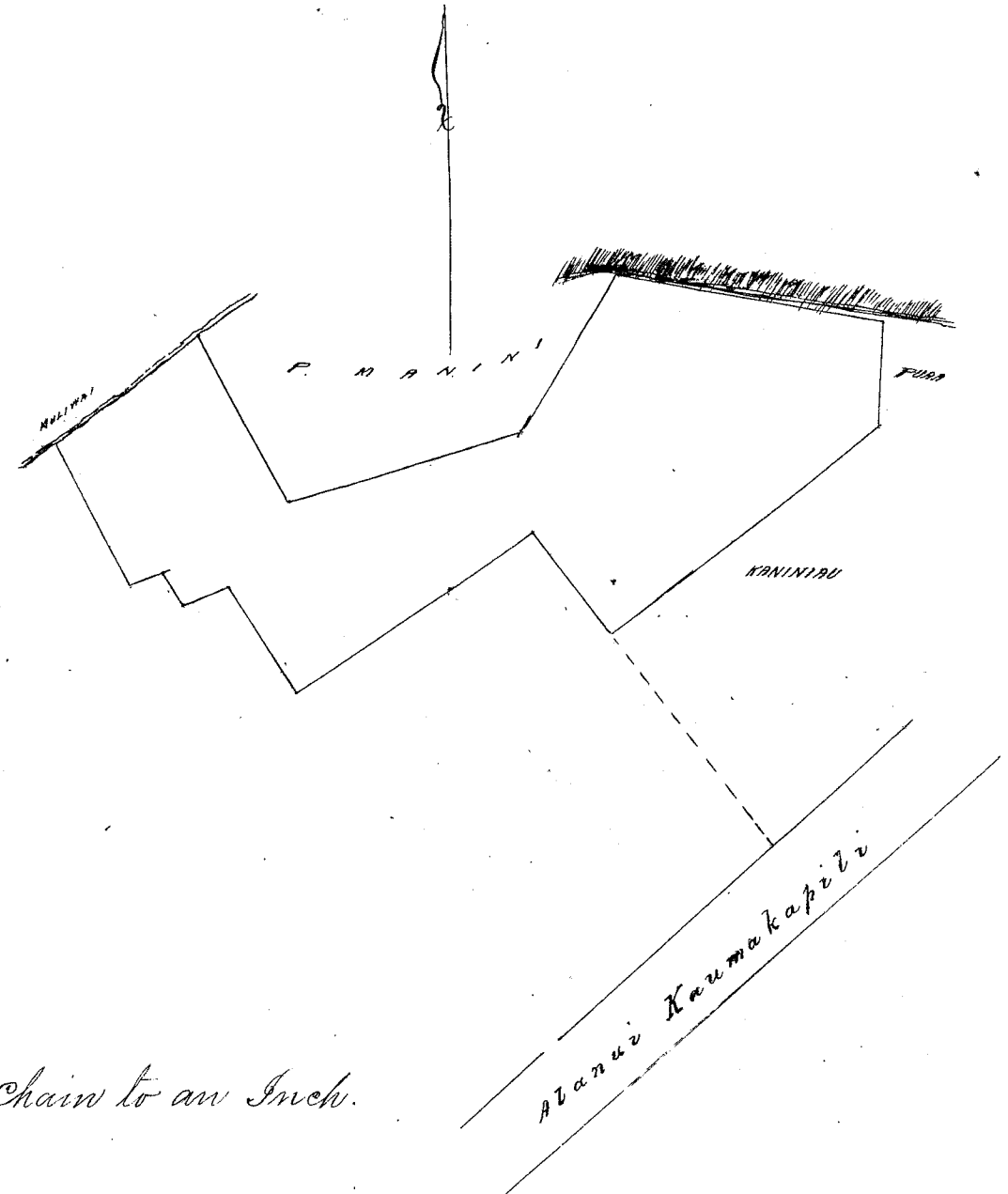

Scale 1 Chain to an Inch.

Hele 7767 Nawakalaau

Ua koi mai oia no kona mau Apua ana ma Puunui i Honolulu, ma Kona, ma ka Mokupuni o
 Oahu; no ka mea, ua loa iaia keia wahi no Pahau mai i ka M. E. 1831, a ua noho keia olelo a hiki i keia manawa.
 Oia ka makou e hooko nei no Nawakalaau ana Kahope; ke kuleana hoi kona maalo iho o ke Aio Alodio.
 Ima e ukui mai oia i ko ke Aupuni hapaha; alaila, ua kupono iaia i ka Palapala Lila Alodio.
 Pono mai iaia ke ukui no ka hookohokolo ame ka hookoholo ana i ka olelo. Penei
 W. L. Lee No ka rumi ame ke pai ana i ka olelo ma ka Nupepa
 G. M. Robertson No ke kope ana i ka olelo koina
 J. H. Smith No ka palapala kii
 J. Kekaulaha No ka kama ana i ka la 11 o November 1851
 No ke kope ana i wa olelo a ma hoike 2/3 Awa
 No ke ana ana i ka la 11 o November 1853.
 No ke kope ana
 No ka hookoholo ana i ka olelo i ka la 19 o November 1853.

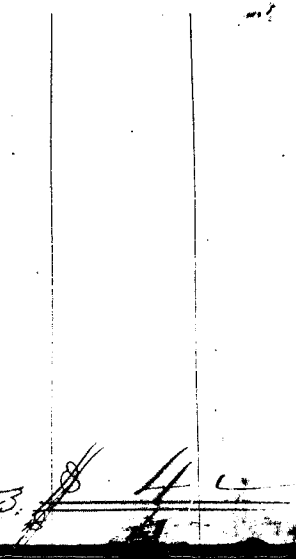

Eia na palena. Aina S.P. Kalamia.

Aina ma Paumotu Honolulu, Kona, Oahu

Apana 1. 11 Loi. E hoomaka ma ke kahi Akaw o keia aina, e pili ana me ka palena o Pili me Aupuni, - E holo ana Kema 30' Kom. 119 Panku, - Kema 59' 30' Hikina 18 Panku, - Kema 41' 45' Kom. 81 Panku, pili me Mahuku no Aupuni, - Alaila Kema 43' 30' Hikina 146 Panku, - Akaw 56' Hikina 24 Panku - Kema 55' Hikina 138 Panku pili me Kalawala no Aupuni a hiki i ke pohaku pea x kahi Komohana o ka Loi o Nahalelaupala, - Alaila Akaw 23' 30' Hikina 233 Panku pili me Nahalelaupala, - Alaila Akaw 58' Kom. 64 Panku pili me ka Loi o Kaakea iho hiki i ke Komohiki, - Alaila Kema 44' Kom. 86 Panku, - Akaw 46' Kom. 85 Panku me Akaw 32' Hikina 59 Panku pili me Aikiu me kahi Loi waiho wale, - Alaila Akaw 55' Kom. 1 Kaulahao pili ana me ka palena o Pili a hiki i ka hoomaka ana Ka Ili 54/100 Eka.

Apana 2. Pahale me Loi. E hoomaka ma ke kahi Hikina o keia aina, e pili ana me ka palena o Pili me Pomanu ma ke kahi Kema o ka auwai, - E holo ana Kema 40' Kom. 168 Panku pili me Pili, - Kema 6' 30' Hikina 118 Panku pili me Aupuni, - Kema 24' Kom. 74 Panku, - Kema 61' 45' Kom. 73 Panku - me Akaw 33' Kom. 138 Panku pili me kahi ame ka pa o Kaiwi, - Alaila Akaw 51' Kom. 130 Panku pili me Kaiwi, - Alaila Akaw 29' Hikina 122 Panku pili me Akawa a hiki i ke pohaku pea x malama o ka auwai, - Alaila Akaw 74' Hikina 72 Panku, - Akaw 83' 15' Hikina 228 Panku pili me ka auwai me Pomanu a hiki i ke hoomaka ana, Ka Ili 63/100 Eka.

Apana 3. 2 Loi. E hoomaka ma ke kahi Kema o keia aina e pili ana me ka palena o Kamaikui, - E holo ana Akaw 13' Hikina 100 Panku pili me Kamaikui, - Alaila Akaw 69' Kom. 41 Panku pili me Pili no Pehu, - Alaila Kema 29' Kom. 104 Panku pili me Pomanu, - Alaila Kema 7' Hikina 72 Panku pili me Pahu a hiki i ke hoomaka ana Ka Ili 51/1000 Eka.
Eia ka Ili a pau 1 227/1000 Eka

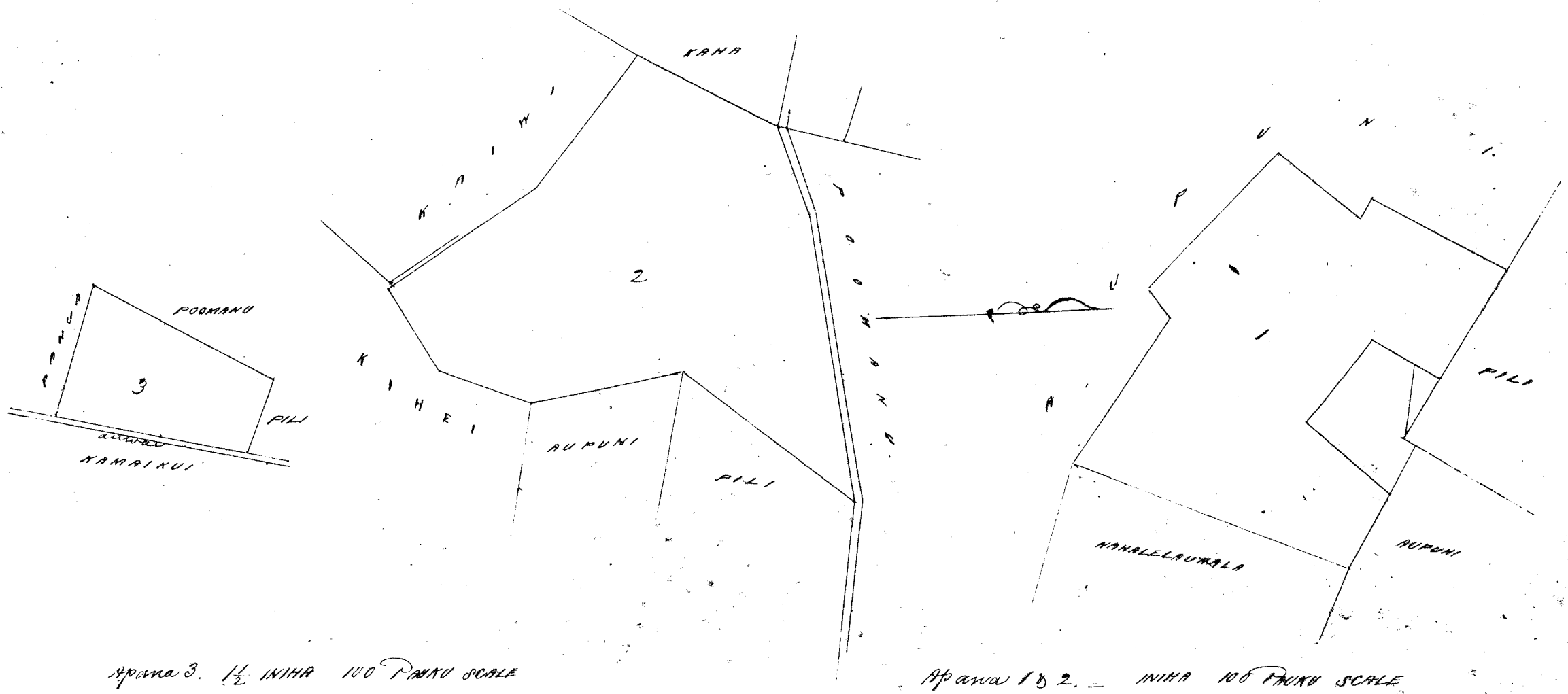

Apana 3. 1/2 INIHA 100 PANKU SCALE

Apana 1 & 2. - INIHA 100 PANKU SCALE (see before)

Helu 7775 Pakuaina

Ua koi mai oia no kona mau Apana aina ma Kuakaukui me Keuato, me Auwaiolima i Honolulu, ma Kona, ma ka Aupuni o Oahu, no ka mea, ua hoaihoia keia mau wahi ma Keuato me Auwaiolima no Auwai i ka wa e ola ana o Kaakumanu I, a o na Apana aina ma Kuakaukui, no ka mea wahine ia mau Apana, a ua loa hoi i kumu iuhine o Kaakui no kana kane mua no Aia mai i ka M.H. 183, a ua loa hoi ia hoi no Umiokalani mai i ka wa o Pahi, a ua mohe keakea oia a hiki i ka M.H. 1846, a kahi no a loku ka mea keakea o Pehu ka Lima, Komohiki, a make o Pehu, o Mahuka iho ka Lima, ma no ke keakea ana mai. Eia ke kumu o keia keakea ana mai. Ua koi mai o Pehu me Mahuka i ke kahi Loi i ka jama. Pupu ka iwa ho loi koe, no ke komohiki i Loi a ua hoo ke komohiki. I ka mana ana

ina olelo a ka poe ike pono, ua hoi mai o Kepoo amu Kuinoia, amu Namoaualua, he loikele o "Paipai" mai ka
ua kuhiko mai. Nolaia, ua maopopo i ka mana ana, e hoi ia Loi no ke Konoheki, a o na Loi e ike ike i keia
kaakea ana, ua maopopo wa ke kula ana. Aia ke Kane a Kaaukai, a ua maopopo hoi ka moke mau ana o Kaaukai
ka wahi a Kahucina, a ke moke mau nei no a hiki i keia manawa.

Nolaia, ke hooke mai makou no Kahucina amu Kaaukai ia mau wahi; he kula ana hoi kolaua
malalo iho o ke Auo Alodio. Ina e ike mai oia i ke ke Aupuni hapaha; alaila, ua kupaona ia ia ka palapala
kila Alodio.

Pono mai ia ia ke ike no ka hookelelo amu ka hookelelo ana i ke olelo. Penci
W. L. Lee
G. M. Robertson
J. H. Smith
S. Kaulahao

No ka rumi amu ke fai ana i ke olelo ma ka Mupewa
No ke kope ana i ke olelo koina
No ka palapala kii
No ka hana ana i ka la 4 o Maraki 1851.
No ke kope ana i na olelo a na hoi ke 2 aous
No ke hana ana i ka la 14 o November 1853.
No ke kope ana
No ka hookelelo ana i ke olelo ~~hina~~ i ka la 19 o November 1853.

6

Oia na palena. Anania S. P. Kaulana.

Aina ma Paua Konoheki, Kona, Oahu.

Apana 1. Loi ma Kaaukukui. E hoomaka ma ke kii Konoheki a keia Apana aina. -
E holo ana Aka 79' Hikina 62 Panku - Kona 25' 30' Hikina 55 Panku, - Aka 77' Hikina 70 Panku pili me
Kepoo. - Alaila Aka 23' Kona 152 Panku pili me Kaluhikaua, - Alaila Kona 79' 30' Kona 121 Panku, amu Kona
10' Hikina 77 Panku pili me Konoheki a hiki i ke hoomaka ana, - Ka Ili 15/100 Eka.

Apana 2. Loi ma Kaaukukui. E hoomaka ma ke kii Aka amu ka keia Apana aina,
E holo ana Kona 23' Hikina 380 Panku, - Kona 29' Hikina 92 Panku pili me Konoheki amu Namoaualua, - Kona 67'
Kona 96 Panku pili me Konoheki. Alaila Aka 25' Kona 83 Panku - Aka 23' Hikina 11 Panku, - Aka 22' 30' Kona
174 Panku. - Aka 29' Kona 58 Panku pili me Uluu. - Aka 23' Kona 158 Panku pili me Konoheki. Alaila Aka 72'
Hikina 84 Panku pili me Namoaualua a hiki i ke hoomaka ana, - Ka Ili 44/100 Eka.

Apana 3. Loi me Kula ma Kewalo. E hoomaka ma ke kii Kona o ka papohaku o J.
Booth, E holo ana Kona 14' 30' Hikina 208 Panku, a nei ike 5 Panku keke, a Kona 29' Hikina 108 Panku pili me
Kamulimili, Kona 19' Hikina 3 1/2 Kaulahao - Kona 56' 15' Kona 23 Panku, - Kona 28' Hikina 174 Panku pili me Ino
amu Konoheki. Alaila Aka 55' Hikina 65' Panku pili me Ili Kapala, - Alaila Aka 16' Kona 337 Panku; Aka 68'
Hikina 160 Panku pili me Puumi, - Alaila Aka 16' Kona 240 Panku pili me Ino amu Kaulahao, - Aka 18' 15' Kona 450
Panku pili me Kaulahao a hiki i ke papohaku o J. Booth, - Alaila Kona 28' Kona 313 Panku pili
me papohaku o J. Booth a hiki i ke hoomaka ana, - Ka Ili 153/100 Eka

Apana 4. Pahala ma Auwiohina. E hoomaka ma ke kii Aka o keia pahala pili me
Lacnuu, E holo ana Kona 58' 45' Kona 478 Panku pili me Kamakauia amu Kamamaka, Alaila Kona
21' 45' Hikina 274 Panku, - Aka 70' 45' Hikina 137 Panku pili me Konoheki, Alaila Aka 27' Kona 134 Panku,
- Aka 52' Hikina 155 Panku, - Kona 53' Hikina 114 Panku pili me Akaioulu, - Alaila Aka 58' 20' Hikina
101 Panku, - Aka 64' 30' Hikina 116 Panku pili me Namoaualua, - Alaila Aka 38' Kona 255 Panku pili
me Lacnuu a hiki i ke hoomaka ana, - Ka Ili 1 5/100 Eka

Oia ka Ili a pau 3 13/100 Eka.

14 November 1853.

S. P. Kaulana
Una Aina

Eia na palena. Anisia e S.P. Kalama.

Kulokohou, Kuleana Pahale ma Honolulu, Kona, Oahu.

E hoowaka ma ke kiki Hea e pili ana me ka palena o Kaalua no Namakeha, a e holo i ke Hea 54' komu 15 1/2' no. Kaulahao e pili ana me Kaalua no Namakeha a hiki i ke kiki Komohana o keia e pili ana me ke Kuleana o Kamahalo. Alaila Hea 55° 30' Hiki. 1 1/4' no Kaulahao e pili ana me ke Kamahalo a hiki i ke kiki Hea o keia Pahale e pili ana me ka aino o ke Aupuni. Alaila Hea 56° Hiki. 2 3/4' no Kaulahao ma ke aino o ke Aupuni a hiki i ke aino. Alaila huli a holo 1 7/8' no Kaulahao ma ke aino ma ke aino o keia Kuleana a hiki i ke kiki i hoowaka i

Sloko o ia Pahale 337 Anama 10 Kapuai.

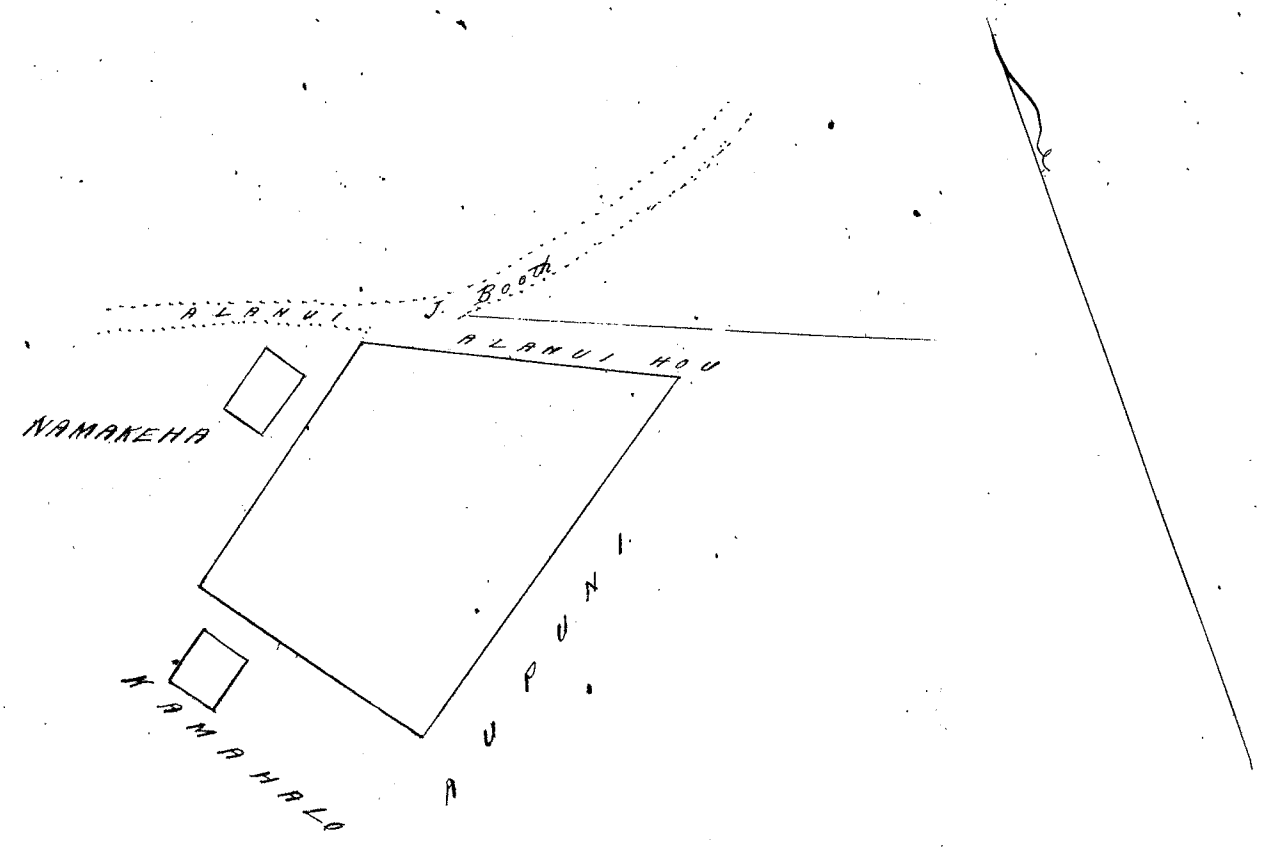

SCALE
INCH = KAULAHAO

Hele 42. Kaluaokamano

Ua koi mai oia no Kona Apuna aino ma Kamani, ma Lahaina, ma ke Mokupuni o Maui. no ka mea, ua loaa ia ia keia wahi no Mokuhlohehuu mai kana wahine, a ua loaa hoi i kana wahine no kana kane mua mai o Papa, a ua loaa hoi ia Papa no ke Alii Kamohamoha III i ka M. H. 1840, a ua noho keia oleia a hiki i keia manawa

Oia ka makou e hoko me no Kaluaokamano; he kuleana hoi kona ma ke ano o ke Ano Alodio. Ina e hoko mai oia i ke ke Aupuni hapaaha; alaila ua kupono ia ia ka Palapala Sila Alodio.

Tonae ia ia ke ukw no ka hoko hoko amu ka hoko hoko ana i ke olelo. Penei, -

- W. L. Lee
- G. M. Robertson
- J. H. Smith
- J. Kaulahao

- No ka oumi amu ke pua ana i ke olelo ma ke Napepa
- No ke kope ana i ke olelo koina
- No ka palapala hii
- No ka hana ana i ka la 19 o Augate 1853.
- No ke kope ana i ma olelo ana hoi ke 1/2 aao.
- No ke ana ana i ka la
- No ke kope ana
- No ka hoko hoko ana i ke olelo i ka la 22 o November 1853.

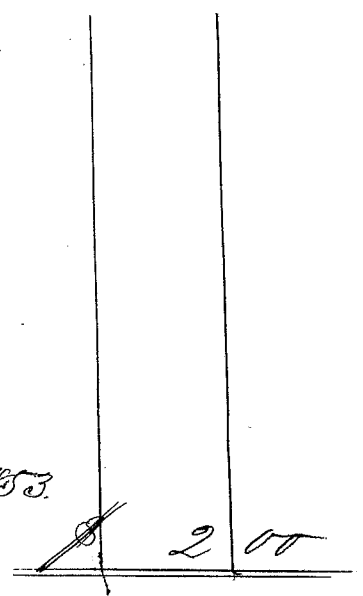

Eia na palena. Anisia e S.P. Alexander

Aia kona aino kuleana ma ke Ahupuaa o Kamani ma Lahaina, Maui.

E hoowaka ana ma ke kiki Hea Heikina, a e holo ana

A	45 1/2	Ke	0.81	Kaul.	e pili ana me ke Alanui
He	44 3/4	Ke	1.42	"	Puniwai
He	48 1/2	Ke	0.80	"	Kahakai
A	44 3/4	Ke	1.37	"	Kona aino iho, a hiki i ke kiki i hoowaka ai.
				Ku Ili	17 mau Roda.

S.P. Alexander
Mea Ananina

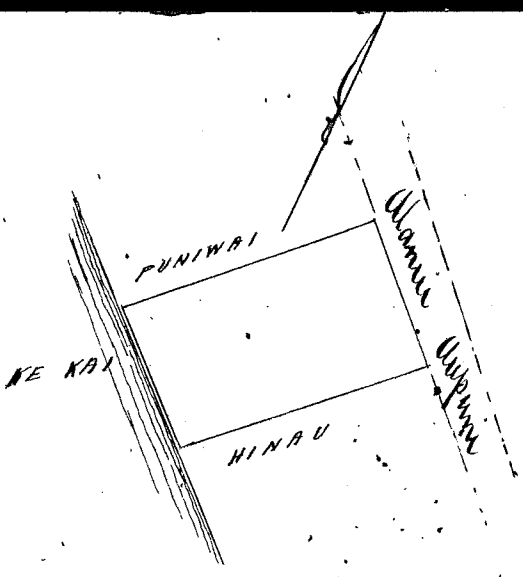

1 kaulahao = 1 Iuka.

Kelu 7182 Kapalahaole

Ua koi mai oia no kona Kapalahaole o ke Ahupuaa Kaunamano, ma Hamakua ma ke Motu
 puni o Hawaii; no ka mea, ua loa ia ia, keia iaina no ke Alii Kamehameha III, mai i ka Mahale aia ana
 ka M.S. 1848, a ua noho keia oia a hiki i keia manawa.

Oia ka makou i hooko mai no Kapalahaole a ia Maraca kona makuahine, ke kuleana hoi kona
 mulalo iho o ke Ano Alodio. Ina e hiki mai oia i ke ke Ahupuaa, hapaha; aia, ua kupono ia ia ka Palapala o
 Alodio. Aka, ke nui na kuleana o makuahine ma ka makou.

Tonoa ia ia ke ukia no ka hooko o keia i keia olelo. Penei

- | | |
|-----------------|---|
| W. L. Lee | No ka nui o keia i keia olelo ma ka Mijepa |
| G. M. Robertson | No ke kope ana i keia olelo koina |
| J. H. Smith | No ka palapala kii |
| J. Kekaula | No ka hana ana i kaia 1, o Sepatemaba 1853. |
| | No ke kope ana i na olelo a wa piri ke |
| | No ka ana ana i kaia o October 1853. |
| | No ke kope ana |
| | No ka hooko ana i keia olelo i kaia 22 o November 1853. |

Eia na palena. Anaia o C. J. Lyons

Ahupuaa o "Kaunamano", Hamakua, Hawaii.
 E hooko ana ma ka pahu aia Oia hoailonaia x ma kahawai i pili ana mo Keneheneula, ma
 ke kahi Komohana ma keia; a e holo ana ma ka palena o ke kapu Ahupuaa oia 81 1/2 Iki. 1560 kapu a hiki i ka hana
 ma ka palena o Kaunamano; aia iho ana ma ia kahawai a hiki i ka hana; aia ma ka hana a hiki i ka hana ma
 ka palena o Keneheneula; aia iho ana ma ia kahawai a hiki i ka hana i komohana i.

Maloko o keia 157 Eka.

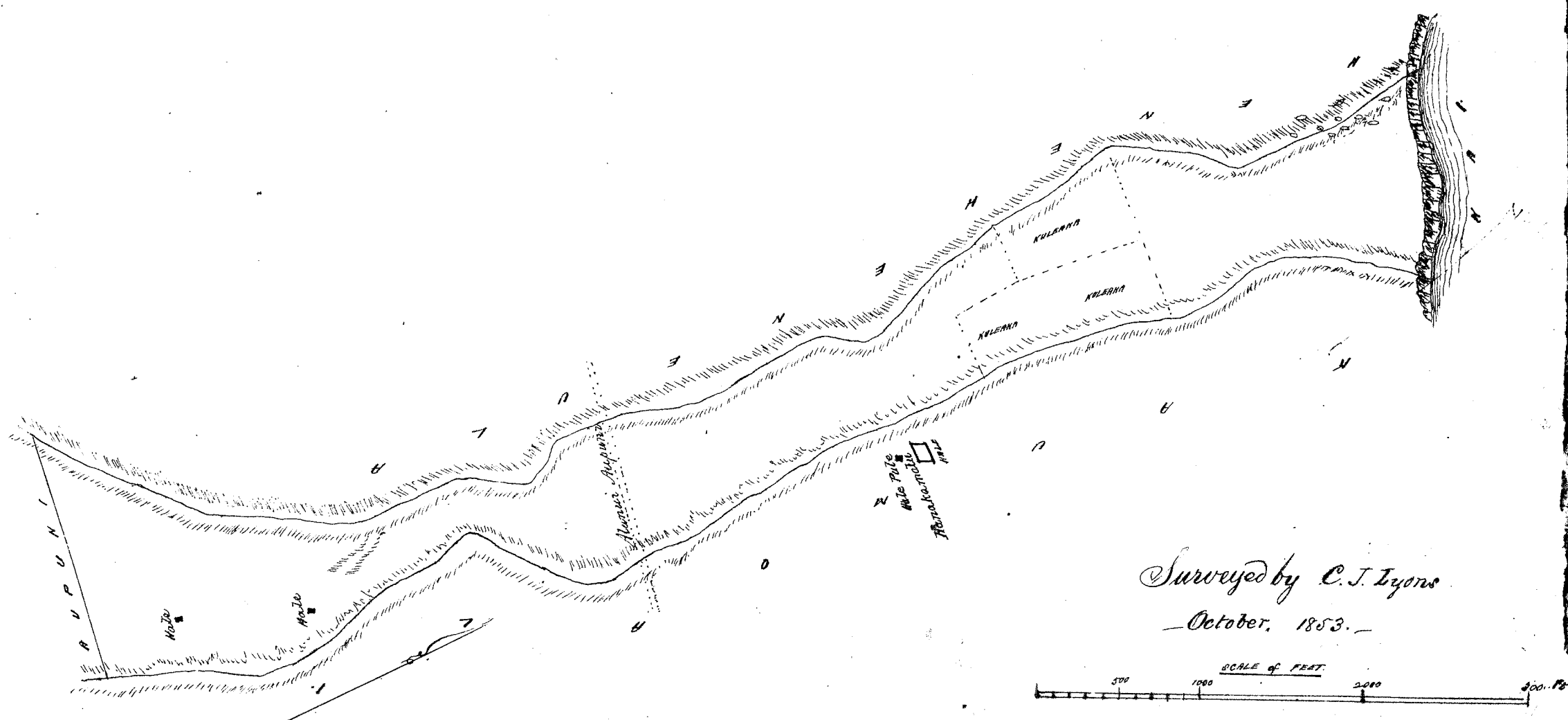

Surveyed by C. J. Lyons
 - October, 1853.

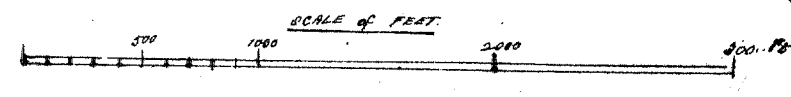

B. Helu 9383, Liukua

Ua koi mai oia no kona mau Apama aino ma Pukuehuni, ma Lahaina, Maui, ma ka Motupuni o Maui; no ka mea, ua loaa ia ia keia mau wahi no Kapehuna mai ke Konohiki i ka M. S. 1839, a ua noho keakea oia a hiki i keia manawa.

Oia ka makou e hoohe me no Liukua; he kuleana hoi, kama matalo iho e ke Ano Alotio. Ana e uku mai oia i ke ke Aupuni hapaha; alaila, ua kufono ia ia ka Palapala Sila Alotio.

- W. L. Lee No ka oumi ame ke pai ana i ka olelo maika Nupopa
- G. M. Robertson No ke kope ana i ka olelo koina
- J. H. Smith No ka palapala kii
- J. Mekauihao No ka hana ana i ka law 17 o August 1853.
- No ke kope ana i na olelo a ma hoi ke 1/2 Awas
- No ke ana ana i ka law
- No ke kope ana
- No ka hoohe ana i ka olelo i ka law 23 o November 1853.

--	--

Eia na palena. Anaia e W. P. Alexander

Aia ke waiho ka kona kuleana maika Aupuni o Pukuehuni ma Lahaina, Maui

Apama 1. E hoomaka ana ma ke kiki Kama Kikina, a e holo ana

A	33°	Ko	1.77	Kaul. e pili ana me Moku	
Ke	78 1/4	Ko	1.09	"	Kauniumi
Ke	72 1/4	Ko	1.09	"	Poalina
Ke	38 3/4	Ki	2.38	"	Iwa
A	58°	Ki	1.86	"	O i kahi i hoomaka ai
		Ka Ili		1 Roda + 26 Roda	

Apama 2. Ma ka Ili o Kaalo maika. E hoomaka ana ma ke kiki Kama Komohana, a e holo ana

A	19 1/2	Ki	1.75	Kaul. e pili ana me Iwa	
Ke	85 1/4	Ki	1.23	"	"
A	15 1/2	Ko	1.73	"	" + Poalina
Ke	88 3/4	Ki	1.63	"	Poalina
Ke	20°	Ko	0.78	"	"
Ke	65°	Ki	0.63	"	"
A	11 1/4	Ki	0.70	"	"
Ke	78 3/4	Ki	1.36	"	Konohiki
Ke	17 1/2	Ki	1.89	"	O
Ke	72°	Ko	1.08	"	Kauakahi
Ke	18 1/4	Ki	0.33	"	"
Ke	67°	Ko	1.58	"	"
A	82°	Ko	2.95	"	Kahawai i kahi i hoomaka ai
		Ka Ili		Kookahi Eka + 30 Roda.	

Apama 3. Ke Kula i paai i ka pa. E hoomaka i ke kiki Kama Kikina, a e holo ana

Ke	20°	Ki	1.40	Kaul. e pili ana me Iwa	
Ke	51 1/4	Ko	5.17	"	Kahawai + Kaniho
A	26 1/4	Ko	2.78	"	Konohiki
A	59 3/4	Ki	3.94	"	Kapu
A	86 1/4	Ki	1.41	"	" i kahi i hoomaka ai
		Ka Ili		Kookahi Eka + 32 Roda.	

W. P. Alexander
Ma Anaina

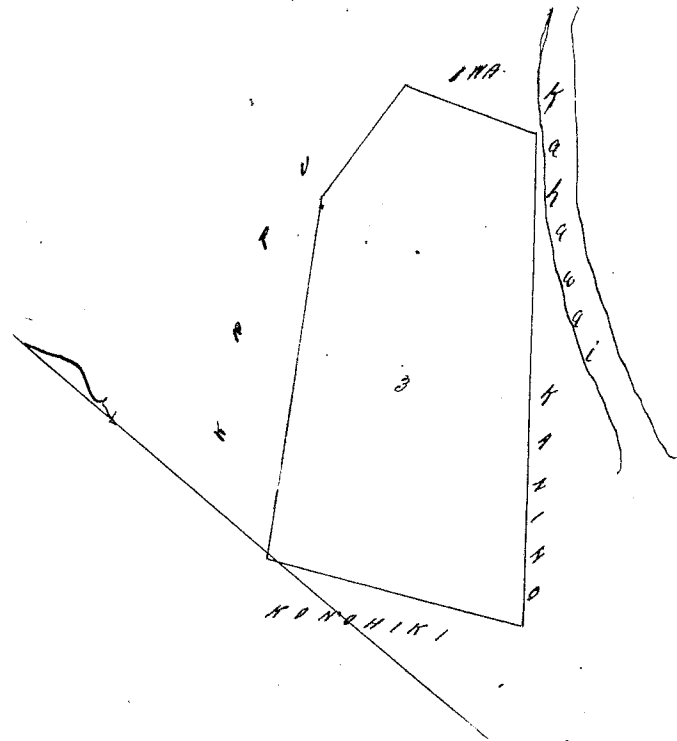
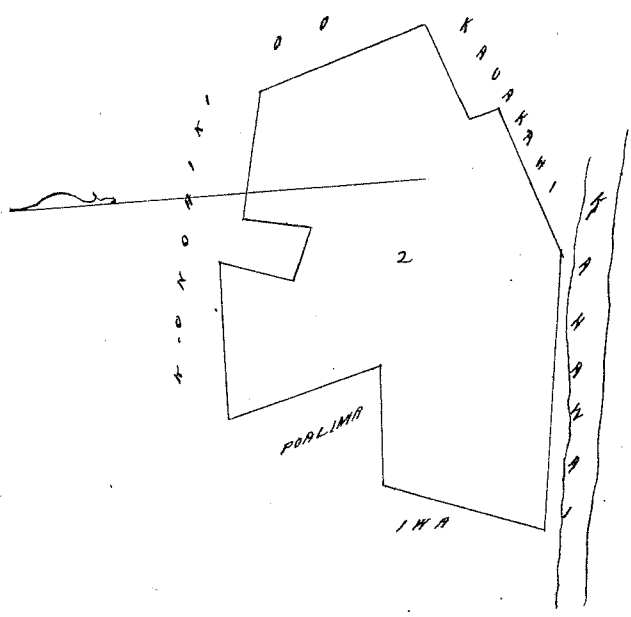
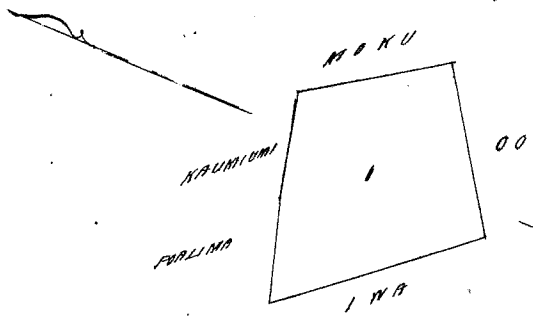

Hele 4878 P. Kaiaia

Ua hoi mai oia no kona Apana aino ma Puhuehuiki, ma ~~Lahaina~~ Lahaina, ma ka Moku o Maui; E hoomaka ana ma ke hiki Helema Helema, a e holo ana no ka mea, ma loa ia ia keia wahi no Kapuipua ma Helema noho keakea oia a hiki i keia manawa.

Oia ka moku e hoko nei no Kaiaia; he kuleana hoi kona malalo iho o ke Ano Alodio. Ina e uku mai oia i ke ke Ahupuaa hapaha; alaila, ua kupo ia ia ka Palapala Sika Alodio.

Pono nae ia ia ke uku no ka hoholo ana i ke olelo, Penii,

W. L. Lee
G. M. Robertson
D. M. Smith
J. Kekaulaheo

No ka rumi ame ke pui ana i ke olelo ma ka Noppepa
No ke kope ana i ke olelo korina
No ka palapala hii
No ka hana ana i ke la 17. August 1853.
No ke kope ana i ke olelo a na hiko 3 Awa
No ke ana ana i ke la
No ke kope ana
No ka hoholo ana i ke olelo i ke la 23. November 1853.

Eia na palena. Aniaia e W. P. Alexander

Aia ke waiho la kona kuleana ma ke Ahupuaa o Puhuehuiki ma ka i Lahaina Maui.

E hoomaka ana ma ke hiki Helema Helema, a e holo ana ma Helema noho keakea oia a hiki i keia manawa.

He	37 1/4	Ko.	0.94	Kaul. e pili ana me Konohiki	
A	31 1/4	Ko.	1.45	"	"
He	59°	Ko.	1.16	"	"
He	28 1/2	Hi.	0.25	"	"
He	41°	Ko.	0.57	"	"
A	57°	Ko.	1.20	"	"
A	29 1/2	Hi.	4.39	"	Auwai o Kuia
He	5°	Ko.	1.86	"	Konohiki
He	41°	Hi.	0.48	"	Palima
He	47 3/4	Ko.	0.63	"	"
He	46 3/4	Hi.	0.46	"	"
A	49°	Hi.	1.63	"	"
He	44 1/2	Hi.	0.48	"	"
He	52°	Ko.	0.72	"	"
He	32°	Hi.	1.29	"	" i kahi i hoomaka ai.

ka Ili 2 Ruda & 14 Ruda.

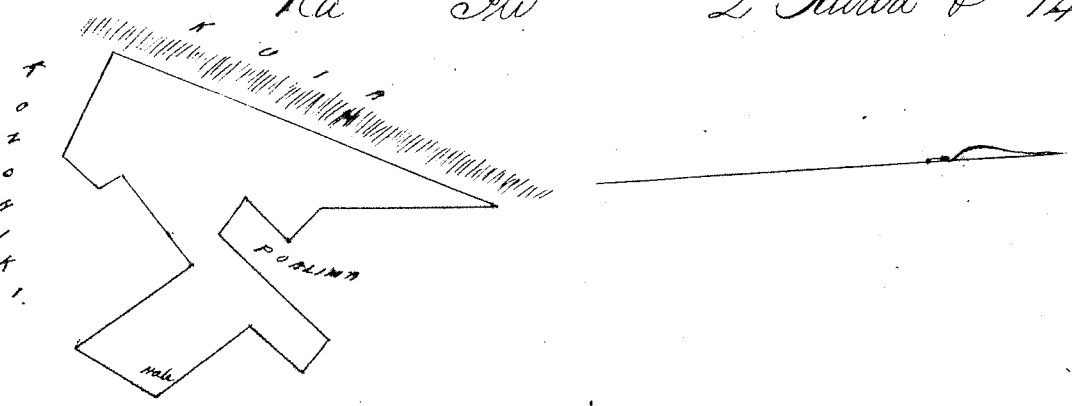

Helu. 6802 Pelekane

Ua koi mai oia no kona wahi o Pahoa i Lahaione, ma ka Mokupuni o Maui; no ka mea, ua hooa ia ia keia mau wahi no

Oia ka makou e hooke nei no Pelekane, he kuleana hoi kona malalo iho o ke Ano Alodio. Ina e uku mai oia i ke ke Aupuni hapaha; alaila, ua kupo ia ia i ka Palapala Sita Alodio.

Pono mae ia ia ke uku no ka hooke kolo ame ka hooke ana i ke olelo, Penei
W. L. Lee
G. M. Robertson
J. H. Smith
J. Kekaulaha

No ka rumi ame ke fai ana i ke olelo ma ka Nupepa
No ke kope ana i ke olelo koia
No ka palapala kii
No ka hana ana i ke la
No ke kope ana i ma olelo a ma hoike
No ke ana ana i ke la
No ke kope ana
No ka hooke ana i ke olelo i ka la 24 o November 1853.

2

Eia ma palena Anua e W. P. Alexander

He kuleana ko Pelekane ma ke Aupuni o Pahoa i Lahaione, Maui

Penei kona ma palena,		E hooake ana ma ke kii Heima Heikina, a e hooke ana	
A 54 3/4	Ko 0.41	Kaul. e pili ana me	Kuapua
He 31	Ko 1.19	"	"
A 56	Ko 0.71	"	"
A 36 1/2	Hi 0.23	"	"
A 40	Ko 0.44	"	"
A 7 1/2	Ko 0.47	"	"
He 19	Ko 0.48	"	Konohiki
He 65	Hi 0.50	"	Kupaliu
He 22 1/4	Ko 0.28	"	"
He 38	Hi 1.36	"	"
A 32 1/4	Hi 2.05	"	"
Ka Ili		25 mau Roda	

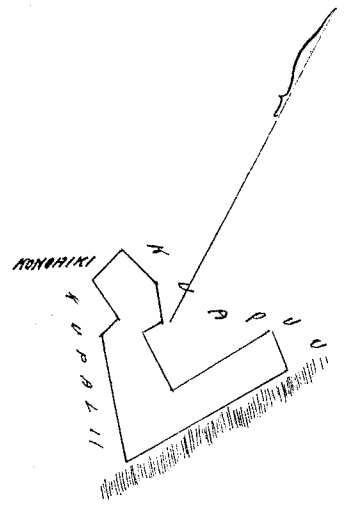

2 Kaul. = 1 Ilika

Helu 6900 Keawolu

Ua koi mai oia no kona wahi ma Pahoa, ma Lahaione, ~~Maui~~ ma ka Mokupuni o Maui; no ka mea, ua hooa ia ia keia wahi no Nalehu, mai i ke No. H. 1838, a ua no ke hea kea o ia i keia mau wahi.

Oia ka makou e hooke nei no Keawolu, he kuleana hoi kona malalo iho o ke Ano Alodio. Ina e uku mai oia i ke ke Aupuni hapaha; alaila, ua kupo ia ia i ka Palapala Sita Alodio.

Pono mae ia ia ke uku no ka hooke kolo ame ka hooke ana i ke olelo. Penei,
G. M. Robertson
J. H. Smith
W. L. Lee
J. Kekaulaha

No ka rumi ame ke fai ana i ke olelo ma ka Nupepa
No ke kope ana i ke olelo koia
No ka palapala kii
No ka hana ana i ke la

No ke kope ana i ma olelo a ma hoi ke
No ke ana ana.
No ke kope ana
No ke hoo holo ana i ka olelo i ka la 24 o November 1853.

Eia ma palena. Anaia e H. P. Alexander

He apuna a ma kuleana o Heawohi i kee ma ke Ahupuaa o Pahaa ma Puhaiwa, Maui
E hoomaka ana ma ke kiki Heima Komohama, a i holo ana

A.	17 1/2	Hi	2,93	Kaul. e pili ana me	Kahawai
He	74 3/4	Hi	0,84	"	Kooka
He	3 1/2	Ko	1,50	"	ka pili
He	40 1/2	Ko	1,70	"	"
A.	63 1/4	Ko	0,51	"	"
				Ka Ali	Puahiwa a hiki i ka hiki i hoomaka ai 1 Puda & 3 Poda

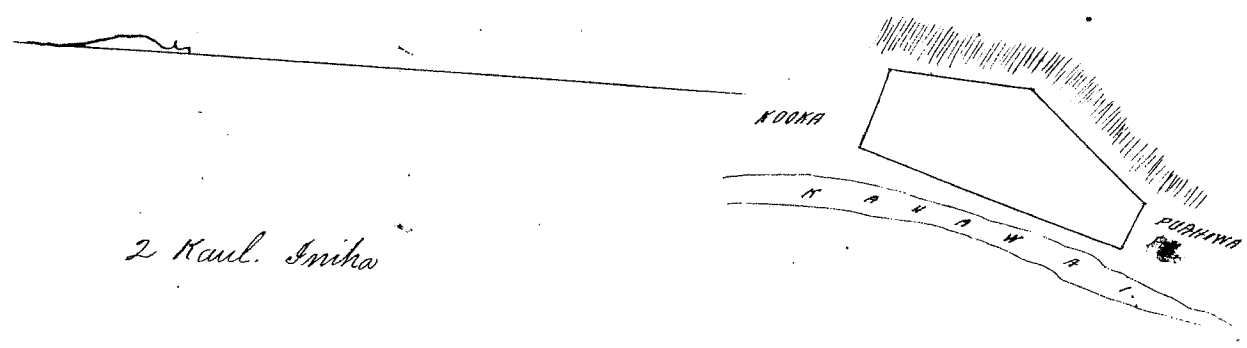

Hele 8515 B Kawaiaha (Page "Kawaiaha" Part 1)

Ua koi mai oia no kona Ahupuaa o Hamonoo ma Puna, ma ke Moku o Hawaii, no ka mea, ua loaa i ia keia aia no ke Alii Kamehameha III mai iloko o ka ^{mapela aia, ana i ka la 12 Feb. 1848.} ~~Ua hooulu ana i ka la 12 Feb. 1848.~~ a i ca mo ho keakea oleia a hiki i keia manawa.

Oia ka makou e hoo komei no Kawaiaha, he kuleana hoi kona malalo iho o ke Ano Alodis. Iwa e iku mai oia i ke ke Ahupuaa hapaha; alaila, ua kupo no ia i ka Palapala Sila Alodis. Aka, kee nae ma kuleana o na kamae maloko.

- Pono nae ia ia ke iku no ke hoo kolo ana i ka olelo. Iwa,
- W. L. Lee No ka oomi ana ke pili ana i ka olelo ma ke Kapepa
- G. M. Robertson No ke kope ana i ka olelo hoiwa
- J. Kekaulahao No ka palapala hoi
- J. H. Smith No ka hana ana i ka la
- No ke kope ana i ma olelo a ma hoi ke
- No ke ana ana
- No ke kope ana
- No ke hoo holo ana i ka olelo i ka la 24, o November 1853.

Ua hoo aku makou i keia kuleana mamuli o ma olelo o ma Kawaiaha i hoo holoia ma ka la 19 o June M. H. 1852, e pili ana i ma Konoehiki.

Hele 8515 B Kawaiaha (Part 2)

Ua koi mai oia no kona Ahupuaa o Opuaa iloko o ke Ahupuaa o Makapala, ma Kihala ma ke Moku o Hawaii, no ka mea, ua loaa i ia keia aia no ke Alii Kamehameha III mai iloko o ka ^{mapela aia, ana i ka la 12 Feb. 1848.} ~~Ua hooulu ana i ka la 12 Feb. 1848.~~ a i ca mo ho keakea oleia a hiki i keia manawa.

Oia ka makou e hoo komei no Kawaiaha, he kuleana hoi kona malalo iho o ke Ano Alodis. Iwa e iku mai oia i ke ke Ahupuaa hapaha; alaila, ua kupo no ia i ka Palapala Sila Alodis, Aka, kee nae ma kuleana o na kamae maloko.

Ua hoo aku makou i keia kuleana mamuli o ma olelo o ma Kawaiaha i hoo holoia ma ka la 19 o June M. H. 1852, e pili ana i ma Konoehiki.

Pono nae ia ia ke uku no ka hookoloholo ame ka hookolo ana ika olelo. Penei,
 W. L. Lee No ka rumi ame kupai ana ika olelo ma ka Nupepa,
 G. M. Robertson No ke kope ana ika olelo keina
 No ka palapala kii
 No ka hana ana ika la
 No ke kope ana ika olelo ama hoike
 No ka ana ana ika la
 No ke kope ana
 No ka hookolo ana ika olelo ika la 24 o November 1853.

5

Helu 8515 B Kavanaeha

Part 3.

Ua koi mai oiu no kona Ili aina o Kalookiu, iloko o ke Ahupuaa o Waipio, ma Hamakua, ma ka Mokupuni o Hawaii, no ka mea, ua hooia ia iwa keia aina no ke Alii Kamehameha III mai iloko o ka Heahekeheke o Hawaii, a ua noho keakea oia a hiki i keia manawa.

Oiu ka waikoue hooko nei no Kavanaeha; hi kule ana hoi kona malalo iho o ke Ano Aloha. Ina e uku mai oia ike ke Ahupuaa hupaha; alaila ua kupono ia ia ka Palapala Situa Aloha. Aka, hoi mau ma kuleana o na kanaka maloko.

Pono nae ia ia ke uku no ka hookoloholo ame ka hookolo ana ika olelo. Penei,
 W. L. Lee No ka rumi ame kupai ana ika olelo ma ka Nupepa
 G. M. Robertson No ke kope ana ika olelo keina
 S. Kikaulaha No ka palapala kii
 S. H. Smith No ka hana ana ika la
 No ke kope ana ika olelo ama hoike
 No ka ana ana ika la 24 o September 1852.
 No ke kope ana
 No ka hookolo ana ika olelo ika la 24 o November 1853.

5

Eia nu palewa. Anaia o C. J. Lyons

Plan of Kalookiu nui, an Ili of Waipio in Hamakua, Hawaii.

Commencing at the East angle of a stone enclosure adjoining the road on the N.E. side of this lot and running S. 68° 45' E. 1000 feet along Kalookiu iki to the bank of a large stream; thence along the boundary of Kahuakalama, S. 15° W. 105 feet to a stake, & S. 28° 30' W. 982 feet to a stone on the boundary of Kuaa; thence along said boundary N. 70° W. 779 feet & N. 15° E. 57 feet, & N. 81° W. 89 feet, & N. 3° E. 33 feet, & N. 68° 30' W. 425 feet ascending a ridge to a Heala Irie; thence along the face of the Pali N. 24° E. 1285 feet to a large stone at the North corner of this lot; thence down S. 54° 15' E. 390 feet to the point of commencement

Containing an Area of 36.6 Acres.

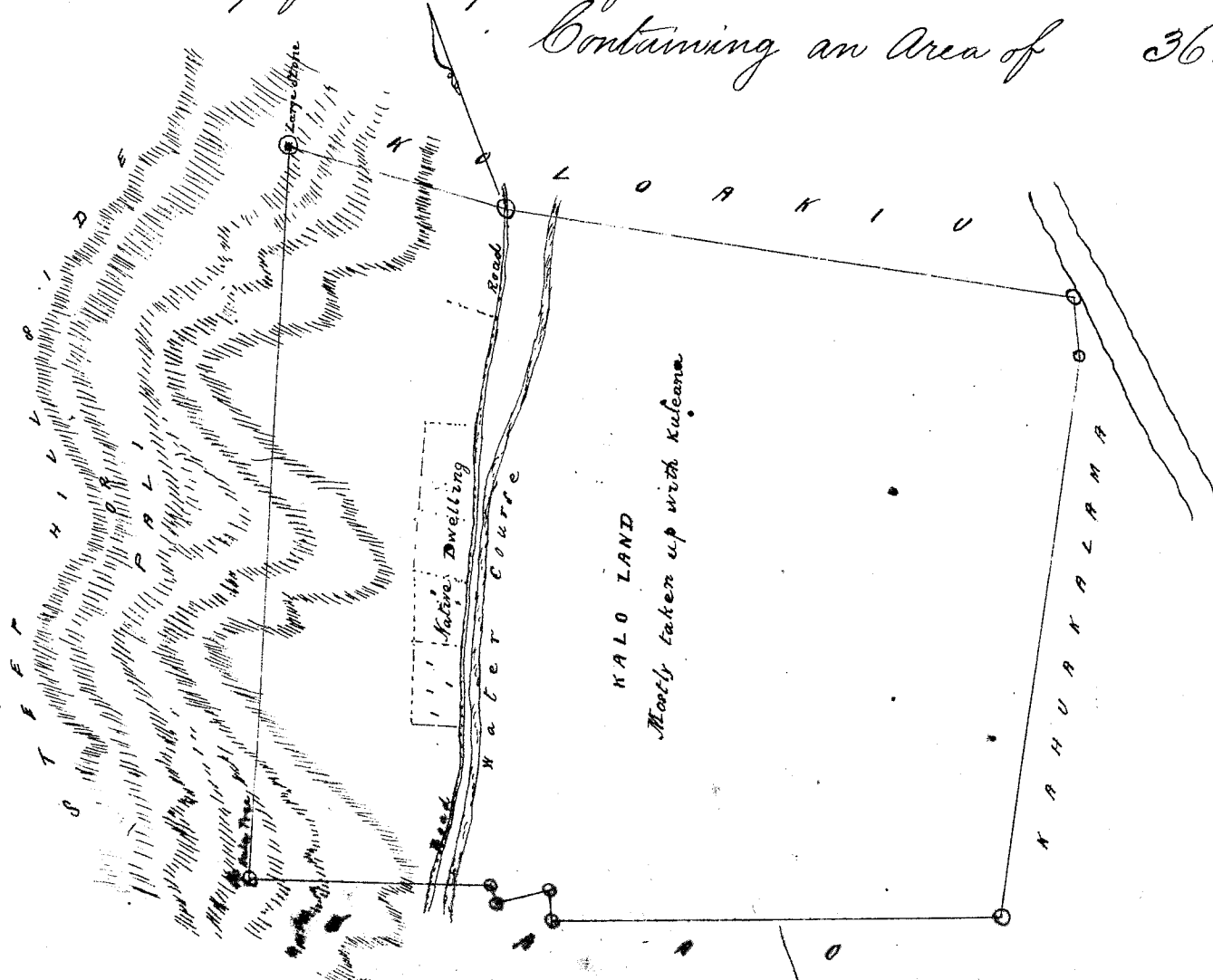

Part 4.

Ua koi mai oia no kona Ahupuaa ike o Koovaliohalawa ike o ke Ahupuaa o Kalawa, ma Kohala, ma ka Mokupuni o Hawaii; no ka mea, ua hooia ia ia keia wahi no ke Alii Kamehameha III mai i ka Mahi aino ana i ka la 12 o Februari 1848, a ua moto keakea oia a hiki i keia manawa.

Oia ka makou e hooko nei no Kavanaka; he kuleana hoi koma malalo iho o ke Ano Alodio. Ina e uku mai oia i ke ke Ahupuni hapaha; alaila, ua kupo ia ia ka Palapala Sila Alodio. Aka, hoo nae na kuleana o ma kanaka maloko. - Pono nae ia ia ke uku no ka hookolokolo ame ka hookolo ana i ka olelo. Penei, -

- W. L. Lee
 - G. M. Robertson
 - A. Kekaulahao
 - J. H. Smith
- No ka nuni ame ke pui ana i ka olelo ma ka Kupuha.
 - No ke kope ana i ka olelo koma
 - No ka palapala kii
 - No ka hana ana i ka la
 - No ke kope ana i na olelo hoi ke
 - No ke ana ana i ka la
 - No ka kope ana
 - No ka hookolo ana i ka olelo i ka la 24 o November 1853.

5

Ua hooko aku makou i keia kuleana mamuli o na olelo o na Kanawai i hookoloia ma ka la 19 o June M. H. 1852, e pili ana i na Honohiki.

Part 5.

Ua koi mai oia no kona Ahupuaa o Kalalawa, ma Kohala, ma ka Mokupuni o Hawaii; no ka mea, ua hoo ia ia keia aino no ke Alii Kamehameha III mai i ka Mahi aino ana i ka la 12 o Februari 1848, a ua moto keakea oia a hiki i keia manawa.

Oia ka makou e hooko nei no Kavanaka; he kuleana hoi koma malalo iho o ke Ano Alodio. Ina e uku mai oia i ke ke Ahupuni hapaha; alaila, ua kupo ia ia ka Palapala Sila Alodio. Aka, hoo nae ia ia na kuleana o ma kanaka maloko.

Ua hooko aku makou i keia kuleana mamuli o na olelo o na Kanawai i hookoloia ma ka la 19 o June M. H. 1852, e pili ana i na Honohiki.

- W. L. Lee
 - G. M. Robertson
 - A. Kekaulahao
 - J. H. Smith
- Pono nae ia ia ke uku no ka hookolokolo ame ka hookolo ana i ka olelo, Penei
 - No ka nuni ame ke pui ana i ka olelo ma ka Kupuha.
 - No ke kope ana i ka olelo koma
 - No ka palapala kii
 - No ka hana ana i ka la
 - No ke kope ana i na olelo a ma hoi ke
 - No ke ana ana i ka la
 - No ka kope ana
 - No ka hookolo ana i ka olelo koma i ka la 24 o November 1853.

5

Part 6.

Ua koi mai oia no kona Ahupuaa o Kupuha, ma Kohala, ma ka Mokupuni o Hawaii; no ka mea, ua hoo ia ia keia kuleana aino no ke Alii Kamehameha III mai i ka Mahi aino ana i ka la 12 o Februari M. H. 1848, a ua moto keakea oia a hiki i keia manawa.

Oia ka makou e hooko nei no Kavanaka; he kuleana hoi koma malalo iho o ke Ano Alodio. Ina e uku mai oia i ke ke Ahupuni hapaha; alaila, ua kupo ia ia ka Palapala Sila Alodio. Aka, hoo nae na kuleana o ma kanaka maloko.

Ua hooko aku makou i keia kuleana mamuli o na olelo o na Kanawai i hookoloia ma ka la 19 o June M. H. 1852, e pili ana i na Honohiki.

Pono nae ia ia ke uku no ka hookolokolo ame ka hookolo ana i ka olelo. Penei,

W. L. Lee
G. M. Robertson
J. Kekaulahao
J. H. Smith

No ka rumi ame ke fai ana i ka olelo ma ka Kupepa
No ke kope ana i ka olelo ko inu
No ka palapala kii
No ka hana ana i ka la
No ke kope ana i ma olelo a ma hoike
No ke ana ana i ka la
No ke kope ana
No ka he hohi ana i ka olelo i ka la 24 o November 1853.

5

Kana Aoo 532.

Helu .8515 Keoni Ana

Ua hoi mai oia no kona mau wahi ma Lahuina, ma ka Wokupuni o Maui; mo ka mea, ua hooia ia i ka mau wahi no M. Kekauonohi mai ka hi ma Puako i ka M.H. 1843 mai, a ma ke Alii Kamaha-meha III mai ka hi pahale i fili ana ma ka Baldwin ma Haleu, ma hope iho o ka make ana o Nahienana, a ua noho keakea oleia a hiki i keia manawa.

Oia ka make ana e hooke nei no Keoni Ana; he kuleana hoi kona malalo iho o ke Ano Alodis. Ima e uku mai oia iho ke Ahupuaa hapaha; alaila, ua kufuro ia ia ke Palapalastika Alodis.

Pono ma ia ia ke uku no ka hooke holo ame ka hooke holo ana i ka olelo. Penei,

W. L. Lee
G. M. Robertson
J. Kekaulahao

No ka rumi ame ke fai ana i ka olelo ma ka Kupepa.
No ke kope ana i ka olelo ko inu
No ka palapala kii
No ka hana ana i ka la 25 o November 1853.
No ke kope ana i ma olelo a ma hoike 3 Aoo
No ke ana ana i ka la
No ke kope ana
No ka hooke holo ana i ka olelo i ka la 26 o November 1853.

10

Oia na palena: Anaia e St. P. Alexander

He palapala hooakaka i ke ana ana i kekahi pua ame kekahi loko i ka puaia o "Hoolili," e waiho ana ma ka Ahupuaa o Puako i Lahuina, Maui.

E hoomaka ana ma ke kiki Akau Komohana, a e holo ana

A 58 1/2	Hi	1.75	Kaul. e fili ana me Hamaina
He 32 1/4	Hi	0.75	Kaihekehai
A 60 1/4	Hi	0.32	"
He 24 3/4	Hi	2.46	Laahili
He 35 3/4	Ko	0.64	ma ka hooke holo loko i ka puaia o "Kaalolo" i kekahi puaia.
He 33 3/4	Hi	1.49	"
He 54 1/2	Ko	0.97	ma ka hooke holo loko i ka puaia o "Kaalolo" i kekahi puaia.
A 42 1/2	Ko	1.55	Paki
A 32 1/4	Ko	3.57	" i piki aku i ka hi i hoomaka ai.

Ka Ili Ekolu Puaka o Wahi mau Puaka

Apama 2. He Pahale kuleana kona e waiho ana ma ka Ahupuaa o Haleu, Lahuina i Maui.

Penei kona mau palena. E hoomaka ana ma ke kiki Hamo Komohana a e holo ana

A 38 1/2	Ko	2.62	Kaul. e fili ana me ke Alanui Ahupuaa
A 46	Hi	2.08	Baluwina
He 43 1/2	Hi	2.82	"
He 51 3/4	Ko	2.30	Lahitahi a hiki i ka hi i hoomaka ai.

Ka Ili Hookehi hapalua Eka

St. P. Alexander
mea ana ana.

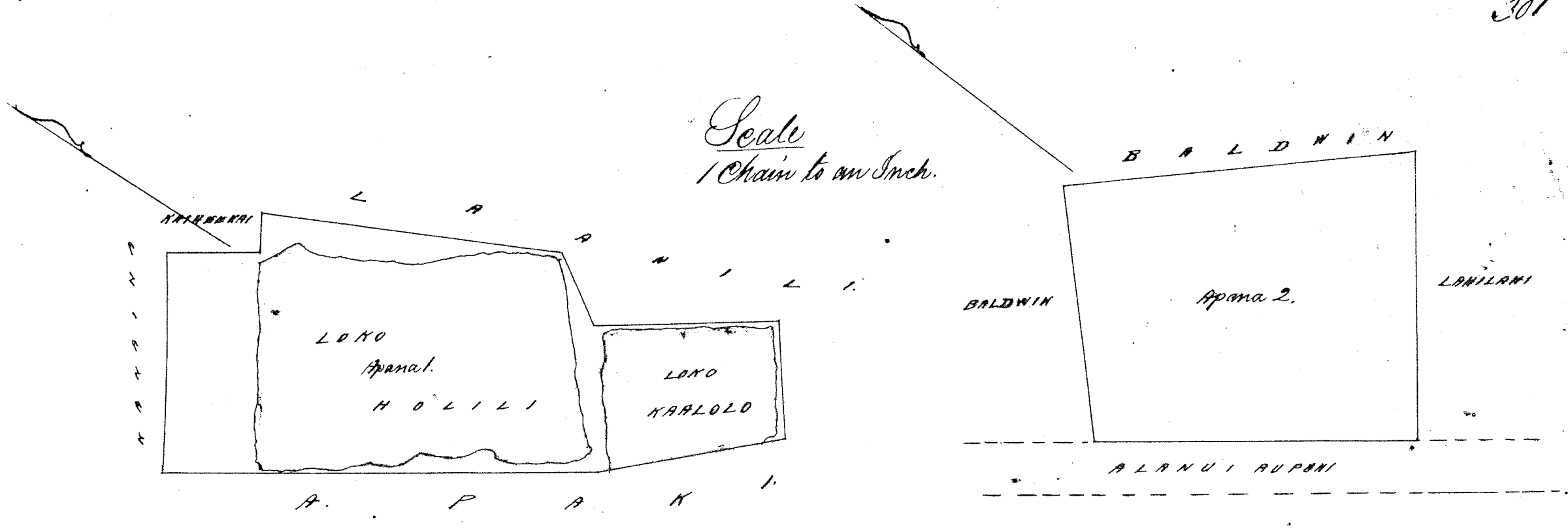

Kele 8519³ Fanny Young
Part 1.

Ua koi mai oia no honu mau wahine ke Ahupuaa o Haleu ma Lohaina, ma ka Mokupuni o Maui; no ka mea, ua loaa ia ia keia mau wahine no ke Alii Hamahamaha III. I mai i keia mahale aia ana i ka M. H. 1843, a ua noho keia oia a hiki i keia manawa.

Oia ka maku e hooke me i no Fanny Young; ke kuleana hoi kona malalo iho o ke Alii Olohe. I ma e ukui mai oia iko ke Aupuni hapaha; alaila, ua kope no ia ia ke Palapala Sila Olohe. Aha, hoi ma e ia ia ma kuleana o ma Kanaka maloko.

I no ma e ia ia ke ukui no ka hooke hooke ana i ke olelo, Puni,

- | | |
|-----------------|---|
| W. L. Lee | No ka rumi ana ke pua ana i ke olelo ma ka Napepa. |
| S. M. Robertson | No ke kope ana i ke olelo koina |
| J. M. Kaulahou | No ke palapala kei |
| W. Smith | No ke hana ana i ke ka |
| | No ke kope ana i ma olelo a ma hiki |
| | No ke ana ana i ke ka |
| | No ke kope ana |
| | No ka hooke ana i ke olelo i ka ka 26, o November 1853. |

Oia ma palena. Aia e H. P. Alexander

Ke palapala hookeke i ke ana ana i ma Apana aia kuleana o Fanny Young e waiho ana ma ke Ahupuaa o Haleu i Lohaina, Maui.

Apana 1.	E hoomaka ana ma ke kahi Kama Koinohana, a e holo ana		
A	41 1/2	Ko	1.59 Kaul. e pili ana me Nahaolelua & Kaluafele
A	16 3/4	Hi	0.09 " " Kaluafele
A	51	Hi	0.24 " " "
A	36 3/4	Hi	0.83 " " "
He	50 3/4	Ko	1.02 " " "
A	22 1/2	Ko	0.27 " " Koaeweluade
A	47 3/4	Ko	1.41 " " Peniumi
A	55 1/2	Hi	0.61 " " Kamaooha
He	32 1/2	Hi	0.58 " " Lono
He	46 1/2	Ko	0.78 " " "
He	38 1/4	Hi	0.48 " " "
A	50	Hi	1.41 " " "
A	15 1/2	Ko	1.29 " " "
A	56 1/4	Hi	1.33 " " Kamaooha
He	16 1/4	Ko	0.64 " " Kana
He	52 1/2	Ko	0.62 " " Auwa
He	40 1/2	Hi	1.31 " " "
A	44 1/4	Hi	0.86 " " "
He	44	Hi	0.48 " " "
		Ko	

Kele 8519³ i kahi hoomaka ana. P. H. d.

Apana 2. E hoomaka ana ma ke kahi Akau, a e holo ana
 He 37 1/4 Ko 1.20 Kaul. e pili ana me Auwaa
 He 32 3/4 Hi 0.81 " " "
 A 58 1/2 Hi 1.17 " " Mua
 A 34 Ko 1.24 " " Hekeu i kahi i hoomaka ai
 Ka Ili 19 mau Roda.

Apana 3. E hoomaka ana i ke kahi Komohana, a e holo ana
 A 60 1/2 Hi 1.50 Kaul. e pili ana me Mua
 He 33 1/4 Hi 0.42 " " Keono
 He 49 1/2 Ko 1.49 " " Polapola
 A 36 Ko 0.69 " " Baluwano i kahi i hoomaka ai.
 Ka Ili 13 mau Roda.

Apr 2 18 19 12
 19
 13
 12
 15
 Et. 2 11
 7
 1.6.34

Apana 4. E hoomaka ana i ke kahi Keena Komohana, a e holo ana
 A 24 1/2 Ko 1.26 Kaul. e pili ana me Keono
 A 61 1/4 Hi 0.60 " " Polapola
 He 24 Hi 1.23 " " Auwaa
 He 63 1/2 Ko 0.60 " " Keono i kahi i hoomaka ai
 Ka Ili 12 mau Roda

Apana 5. E hoomaka ana ma ke kahi Keena Komohana, a e holo ana
 A 13 Ko 1.97 Kaul. e pili ana me Auwaa
 A 76 Hi 0.55 " " Chalakoa
 He 13 1/4 Hi 1.94 " " Koakanu
 He 71 1/2 Ko 0.58 " " Polapola
 Ka Ili 18 mau Roda.

18
 13
 12
 8
 15

Apana 6. E hoomaka ana ma ke kahi Akau Komohana, a e holo ana
 He 16 1/2 Ko 0.43 Kaul. e pili ana me Koakanu
 A 80 1/4 Hi 0.86 " " "
 He 12 1/2 Hi 0.49 " " "
 A 71 1/4 Hi 0.48 " " Polapola
 A 5 1/2 Hi 0.73 " " Waianae
 He 86 Ko 0.72 " " Auwaa
 A 13 1/4 Hi 0.23 " " "
 He 74 1/4 Ko 0.88 " " Koakanu i kahi i hoomaka ai.
 Ka Ili 15 mau Roda

18.2
 1.6.34

Apana 7. E hoomaka ana i ke kahi Keena Komohana a e holo ana
 A 3 Ko 3.97 Kaul. e pili ana me Puakowali
 A 41 1/2 Hi 3.27 " " Alani i Lahainaluna
 He 40 1/2 Hi 1.69 " " Keoni & Kahuli
 He 62 1/2 Ko 0.53 " " Kahula
 He 2 1/2 Ko 4.92 " " "
 A 89 Ko 2.82 " " Kanehou i kahi i hoomaka ai.
 Ka Ili Hooakahi ame ka hapahua Eku.

Apana 8. Aia ma kahi amekai Apana 7 ma Waiaua. E hoomaka ana ma ke kahi Komohana, a e holo ana
 He 31 1/4 Hi 0.59 Kaul. e pili ana me Puunani
 A 72 Hi 0.92 Hekeu
 A 11 3/4 Ko 0.73 Mua
 He 64 1/4 Ko 1.17 " " Makiwa i kahi i hoomaka ai.
 Ka Ili 11 mau Roda

Apana 9. E hoowaka ana ma ke kiki Aha Homohana, a e holo ana
 He 43 3/4 Hi. 0.65 Kaul. e piti ana me Keawe
 A 69 1/2 Hi. 0.75 " " " Kekeo
 A 8 1/2 Hi. 0.52 " " " Lono
 He 79 1/2 Ko. 0.84 " " " ka piti i kahi i hoowaka ai.
 Ka Ihi 7 mau Rodo

J. P. Alexander
 Maui Amamao.

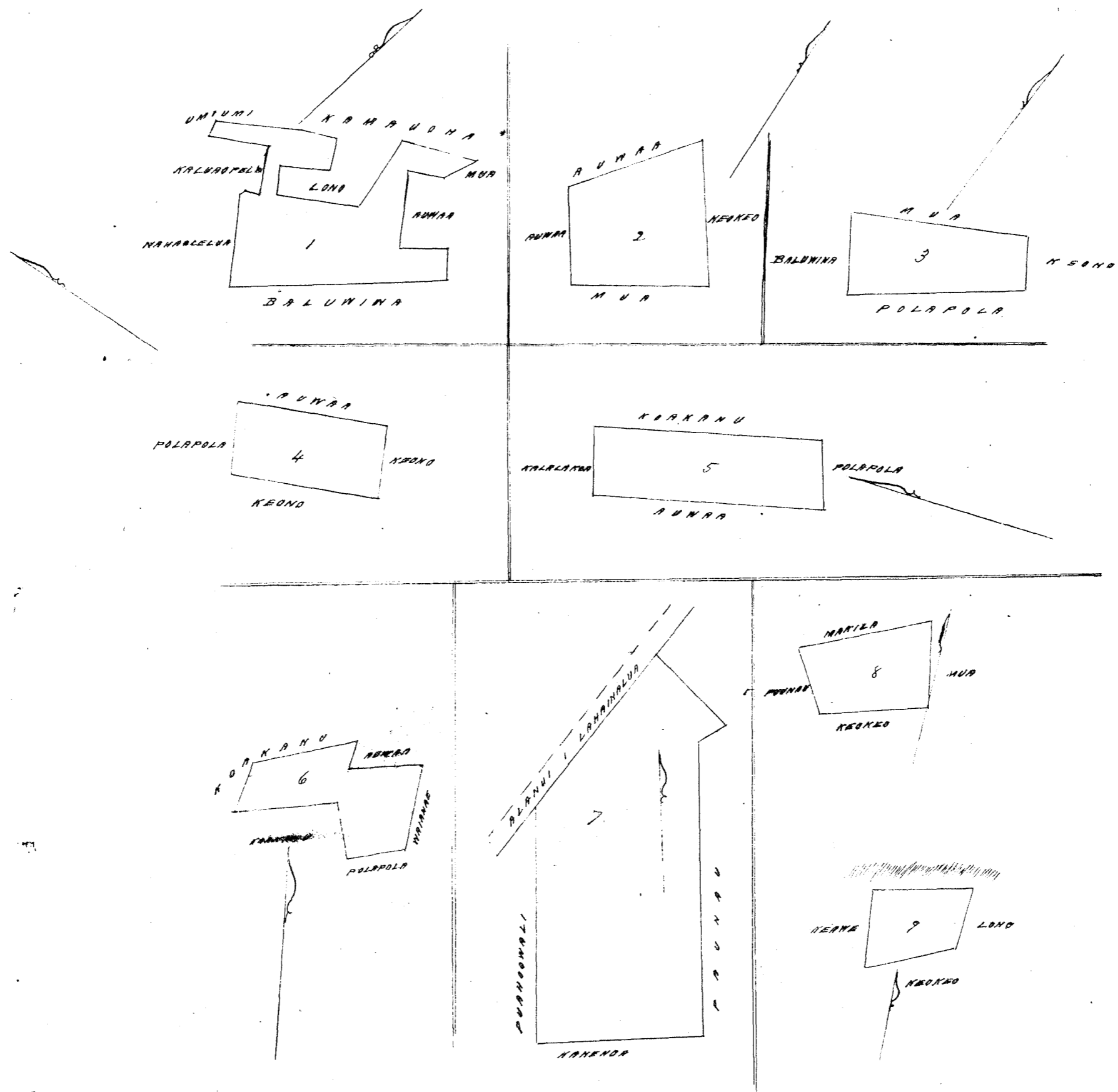

Scale Apana 7. 2 Kaulahas = 1 Inche
 Apana 2, 3, 4, 5, 6, 8, 9. 1 Kaulahas = 1 Inche

Sheet 8519 Fanny Young

Ua koi mai oia no kona Pakala ma Pakala, ma Lahaina, ma ke Moku o Maui, ma ke mea ma
 laa ia ia keia
 Oia ka makou e hooho nei no Fanny Young; he kuni ana koi kona matala iho o ke Aha Aloha. Ima e iho
 mai oia iho ke Aupuni kapaha; alaila, ua hooponi ia ia ke Palapala o ke Aloha.
 Ima ma ia ia ke iho ma ke hooholo kolo ame ke hooholo ana i ke olelo. Pehea
 W. L. Lee No ke rumi ame ke pua ana i ke olelo ma ke Moku o Maui
 G. M. Robertson No ke kope ana i ke olelo ma ke
 J. H. Kaulahas No ke palapala kii
 J. H. Smith No ke hana ana i ke kii
 No ke kope ana i ke olelo ma ke hooho
 No ke ana ana i ke olelo
 No ke kope ana

No ka hooholo ana i ka olelo i ka la 26 o November 1853.

5.1

Oia na palena.

Anaia e S. P. Kalama W. P. Alexander

He palena kuleana kona e waiho ana ma ke Ahupuna o Pakala i Lahaina, Maui.

Penei kona mau palena. E hoomaka ana ma ke kahi Aka Hikiina, a e holo ana

He 32 1/4 Ki 3.73 Kaul. e pili ana me Mamui Ahupuni.

He 64 1/4 Ko 3.11 " " Kauhunui

A 32° Ko 3.60 " mawanaikonu o ka loko o Kaalolo

A 62° Ki 3.11 " e pili ana me Laahiti & Kaalou

a hiki i kahi i hoomaka ai.

Ka Ili

Hookahi Eka & 22 man Roda.

S. P. Alexander
Mea Anaiana

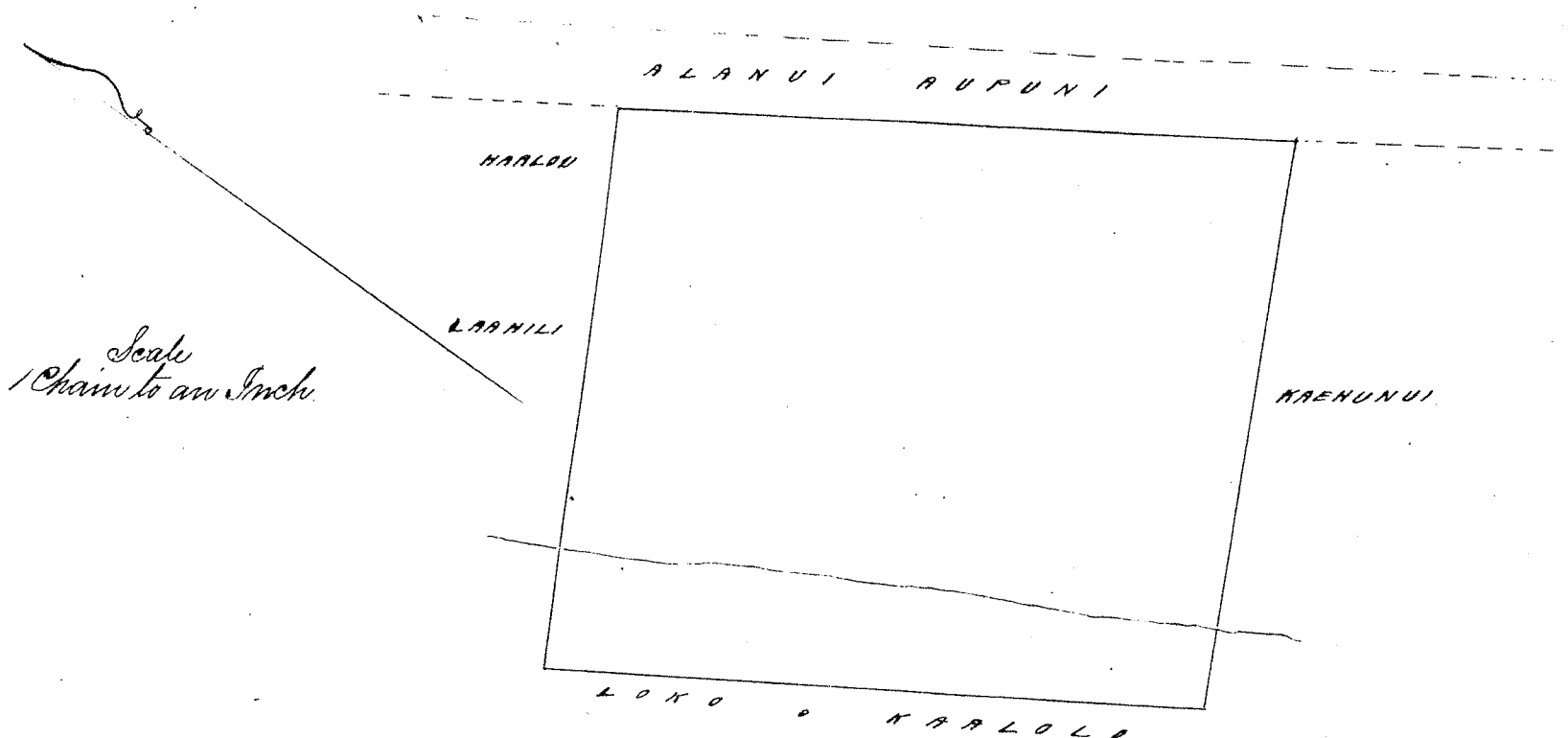

Helu 8519^B Fanny Young Part 2.

Ua koi mai oia no kona Ahupuna o Shiokealani ma Kohala, ma ke Moku o Hawaii, ma ke mea, ua loa ia ia keia Aina no ke Alii Kamehameha III mai i ka Mahalo aia ana i ka M. H. 1848; a ua moho ke akea olelo a hiki i keia manawa.

Oia ka makou e hooke me no Fanny Young; he kuleana hoi kona malalo iho o ke Aho Alodio. Ana e ukui mai oia i ke ke Ahupuni hapaha; alaila, ua kuperu ia ia ka Palapala Lilo Alodio. Aka, hoi mai ma kuleana ana kamaka malalo. Iono mai ia ia ke ukui no ka hooholo ana i ka olelo ma ke hooholo ana i ka olelo. Penei

- W. L. Lee
- G. M. Robertson
- J. Kikaulahao
- J. H. Smith

- No ka rumi ame ke hoi ana i ka olelo ma kea Napepa.
- No ke kope ana i ka olelo hoima
- No ka palapala kii
- No ka hana ana i ka la
- No ke kope ana i na olelo a nahoike
- No ke ana ana i ka la
- No ke kope ana
- No ka hooholo ana i ka olelo i ka la 29 o November 1853.

5.1

Ua hooke aku ma keia i keia kuleana mamuli o na Kanawai i hooholoia ma ka la 19 o Janu M. H. 1852. e pili ana i na Konohiki.

Helu 8519^B Fanny Young

Part 3

Ua hoi mai oia no kona Ahupuaa o Pahoehe ma Kona, ma ka Mokupuni o Hawaii; no ka mea, ua loa ia i ia keia aina no ke Alii Kamehameha III mai i ka Mahalo aina ana i ka M. H. 1848, a ua noho ka kea oleia a hiki i keia manawa.

Oia ka makou e hooke me i na Fanny Young; he kuleana hoi kona malalo iho o ke Ano Alodio. Ina e ukui mai oia i ke ke Auferu i Kapaha; alaila, ua kupo ia ia i ka Palapala Sila Alodio. Aka, hoo mai na kuleana o na kanaka malalo.

Pono nae ia ia ke ukui no ka hooke holo ame ka hooke holo ana i ka olelo, Penei:

- W. L. Lee No ka rumi ame ke pui ana i ka olelo ma ka Nupupu
- G. M. Robertson No ke kope ana i na olelo hoimua
- J. Kekaulahas No ka palapala kii
- J. H. Smith No ka hana ana i ka la
- No ke kope ana i na olelo a na hoike
- No ke ana ana i ka la
- No ke kope ana
- No ka hooke holo ana i ka olelo i ka la 29 o November 1853.

Ua hooke aku makou i keia kuleana mamuli o na Hanawai i hooke holo ma ka la 19 o June M. H. 1852, e pili ana i na Konoiki.

Helu 8519^B Fanny Young

Part 4

Ua hoi mai oia no kona Ahupuaa o Maunalei, ma ka Mokupuni o Lanai; no ka mea, ua loa ia i ia keia aina no ke Alii Kamehameha III mai i ka Mahalo aina ana i ka M. H. 1848, a ua noho keakea oleia a hiki i keia manawa.

Oia ka makou e hooke me i na Fanny Young; he kuleana hoi kona malalo iho o ke Ano Alodio. Ina e ukui mai oia i ke ke Auferu i Kapaha; alaila, ua kupo ia ia i ka Palapala Sila Alodio. Aka, hoo mai na kuleana o na kanaka malalo.

Pono nae ia ia ke ukui no ka hooke holo ame ka hooke holo ana i ka olelo, Penei:

- W. L. Lee No ka rumi ame ke pui ana i ka olelo ma ka Nupupu
- G. M. Robertson No ke kope ana i ka olelo hoimua
- J. Kekaulahas No ka palapala kii
- J. H. Smith No ka hana ana i ka la
- No ke kope ana i na olelo a na hoike
- No ke ana ana i ka la
- No ke kope ana
- No ka hooke holo ana i ka olelo i ka la 29 o November 1853.

Ua hooke aku makou i keia kuleana mamuli o na Hanawai i hooke holo ma ka la 19 o June M. H. 1852, e pili ana i na Konoiki.

Helu 8322 Kamakona (no Kaui)

Ua hoi mai oia no kona Pahale ma Auielet o Katabahine i Honolulu, ma Kona, ma ka Mokupuni o Oahu; no ka mea, ua loa ia i ia keia wahi no Kona mai ka ma waiame ame Kamakanui hoi kona kuleana i ka wa o ka hooke holo ana a M. Kekuanana i ka noho ana o na kanaka, oia ka la 12 o Januari 1847; a ua loa hoi ia Kona ame Kamakanui no ke laua mai ma ka mea mai, o Mer ame Hulikoa, a ua loa hoi ia Mer ame Hulikoa i ka wa o Kamahameha I, a ua noho keakea oleia a hiki i ka la 8 o Novemaba M. H. 1853, ahahi no a lolia ka inuu keakea, o L. Kuaalea ame Auaiwa. Aka, ua hoi mai o Kuaalea, inua o makou, a hoopeu i kona keakea ana; a ua hoi mai a Auaiwa, a hoike mai, noma kela wahi no kona makoukane. Mer, a ua ana ke o Mer ma ka la 12 o Novemaba 1853. E. George Paul, aole no hoi i hooke holo.

Kuleana iki mai o Kuaiwa ame Moo no wa wahila, aole noho i noho mabaila o Kuaiwa mai ka wa o ka make ana o Moo ahiki i ka M. H. 1848 a mailaila mai a hiki i keia la, aole he noho mau ma keia wahi a Kamakua i kuleana mai nei.

Kolaila, ke hooko nei makou no Kamakua a ia Kaia kana keaikamahine e ola ana i keia manawa, he kuleana hoi kona malalo iho o ke Ano Alodio. Ina e uku mai oia i ke Auwahi hapaha, alaila, ua kupa i ia ka Palapala Ika Alodio.

Pono nua i ia ke uku no ka hooko tolo amika hooko ana i ka olelo. Puni,
No ka rami ame kupui ana i ka olelo ma ka Mupipa
No ke kope ana i ka olelo koina
No ka palapala kii
No ka mana ana i ka la 9 o November 1853.
No ke kope ana i na olelo a ma hooko 4 mau
No ke ana ana i ka la
No ke kope ana
No ka hooko ana i ka olelo i ka la 30 o November 1853.

W. L. Lee
G. M. Robertson
S. Kekaulaha
J. H. Smith

Oia na palena. Ania e S. P. Kalama.

Fahala ma "Iwilei," Leli o Kahuwahine ma Honolulu, Kona, Oahu.
E hoomaka ma ka kahi Hikina o keia fahala, i pili ana me ka fahala o Upai ame Kalaloa, -
E holo ana Akau 27° Horn 73 Pautu pili me ka fahala o Kalaloa ma ka aina o ke Konoheki, Akau 42°
Hikina 17 Pautu, Akau 13° 30' Horn 15 Pautu pili me ka fahala o Kalaloa ma ka aina o S. M. Harbottle, -
Alaila Akau 62° 15' Horn 1 Kaulaha, Akau 73° Horn 40 Pautu, - Kema 84° 30' Horn 24 Pautu, - Akau 44°
Horn 58 Pautu pili ana me ka palena aina o S. M. Harbottle, Alaila Kema 23° Horn 92 Pautu, - Kema
2° 30' Hikina 195 Pautu pili me ka auwahi wai i pili ana me ke Ala oleli ma ka aina o ke Konoheki,
ahiki i ke kahi Kema o keia fahala, - Alaila Akau 68° Hikina 149 Pautu pili ana me Konoheki ame ka fahala
o Upai, - Mabalala aku Akau 75° Hikina 115 Pautu ma ka Upai ahiki i ka hoi i hoomaka ai ke ana ana
Eia ka Ili 43/100 Eka.

S. P. Kalama
Awa ana

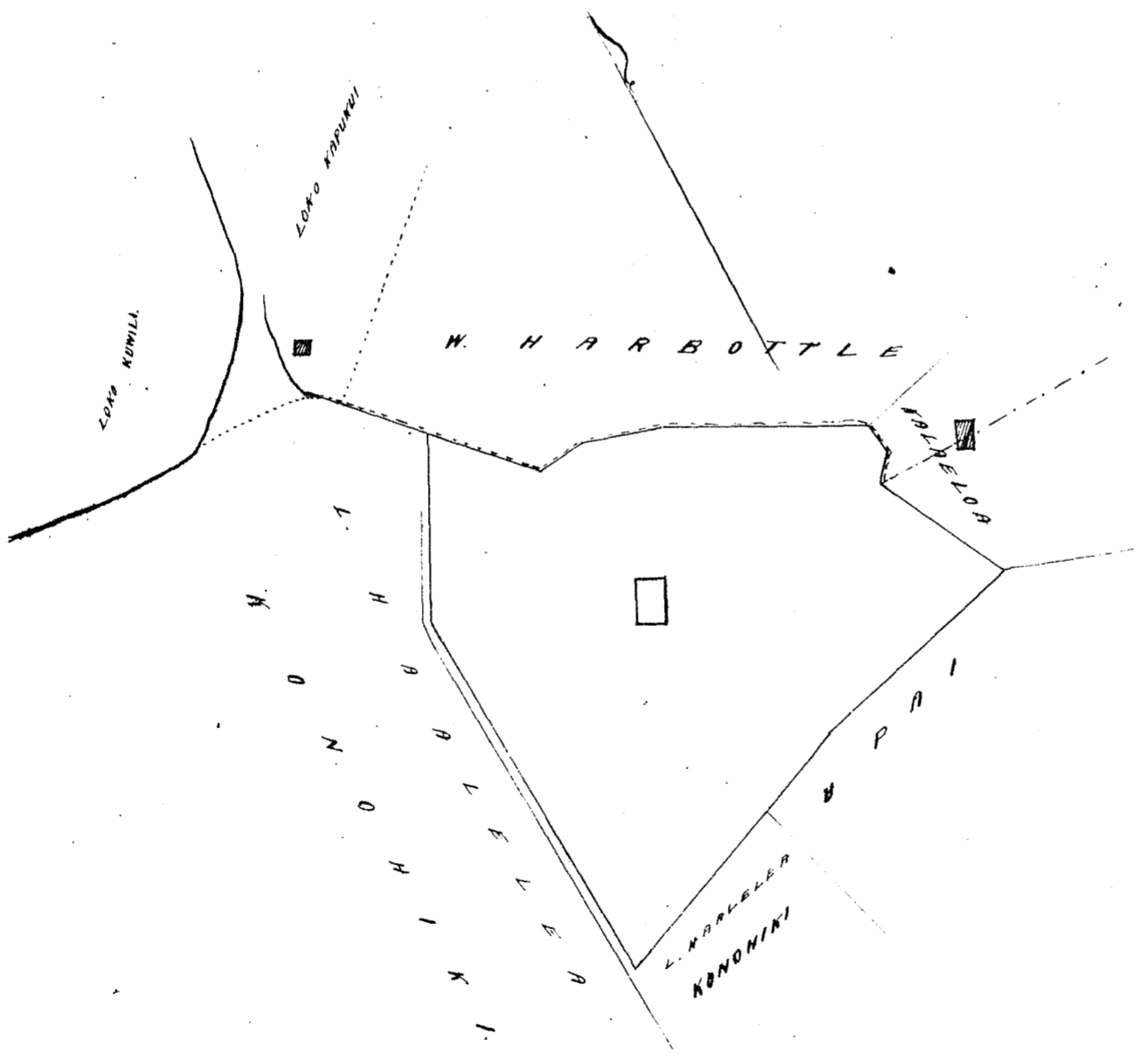

1/4 INCH 100 PAUKU SCALE

Helu 8525^B Julia Kapai Kauwa

Part 1

Ua hoi mai oia no kona Aiaina o Kapahaha i Honolulu, ma Kona, ma ka Mokupuni o Oahu, no ka mea, ua hooia i ia keia aina no ke Alii Hamakamaka III mai i ka Mahale aina ana i ka la 11 o Feberuari 1848, a ua noho keakea oleia a hiki i keia manawa.

Oia ka makou e hooke nei no J. A. Kauwa, he kuleana hoi kona malalo iho o ke Ano Alodis. Ina e uku mai oia i ke ke Aupuni hapaha; alaila, ua kupo ia ia ka Palapala Sila Alodis. Aka, hoo ma e na kuleana o na kanaka maloko.

Pono nui ia ia ke uku no ka hooke holo ana i ka olelo, Penei,

- W. L. Lee No ka oimi ame ke pui ana i ka olelo ma ka Kupupea
- No ke kope ana i ka olelo koia
- G. M. Robertson No ka palapala kii
- J. H. Kaulahao No ka hana ana i ka la
- J. H. Smith No ke kope ana i na olelo a ma hoi ke
- No ke ana ana i ka la
- No ke kope ana
- No ka hooke holo ana i ka olelo i ka la 1 o December 1853

Ua hooke aku makou i keia kuleana mamuli o na Kanawai i hooke ia i ka la 19 o June M. A. 1852, e pili ana i na Kanohiki.

Helu 8525^B Julia Kapai Kauwa

Part 2

Ua hoi mai oia no kona Aiaina o Kailua i Honolulu, ma Kona, ma ka Mokupuni o Oahu, no ka mea, ua hooia i ia keia aina no ka Alii Hamakamaka III; i ka Mahale aina ana i ka la 11 o Feberuari M. A. 1848 a ua noho keakea oleia a hiki i keia manawa.

Oia ka makou e hooke nei no J. A. Kauwa, he kuleana hoi kona malalo iho o ke Ano Alodis. Ina e uku mai oia i ke ke Aupuni hapaha; alaila, ua kupo ia ia ka Palapala Sila Alodis. Aka, hoo ma e na kuleana o na kanaka maloko.

Pono nui ia ia ke uku no ka hooke holo ana i ka olelo, Penei

- W. L. Lee No ka oimi ame ke pui ana i ka olelo ma ka Kupupea
- No ke kope ana i ka olelo koia
- G. M. Robertson No ka palapala kii
- J. H. Kaulahao No ka hana ana i ka la
- J. H. Smith No ke kope ana i na olelo koia a ma hoi ke
- No ke ana ana i ka la
- No ke kope ana
- No ka hooke holo ana i ka olelo i ka la 1 o December 1853

Ua hooke aku makou i keia kuleana mamuli o na Kanawai i hooke ia ma ka la 19 o June M. A. 1852, a ua noho keakea oleia a hiki i keia e pili ana i na Kanohiki

Helu 8525^B Julia Kapai Kauwa

Part 3

Ua hoi mai oia no kona Aiaina o Waialeale i Kauai ma Eleele, ma ka Mokupuni o Oahu, no ka mea, ua hooia i ia keia aina no ka Alii Hamakamaka III mai i ka Mahale aina ana i ka la 11 o Feberuari M. A. 1848, a ua noho keakea oleia a hiki i keia manawa.

Oia ka makou e hooke nei no J. A. Kauwa, he kuleana hoi kona malalo iho o ke Ano Alodis. Ina e uku mai oia i ke ke Aupuni hapaha; alaila, ua kupo ia ia ka Palapala Sila Alodis. Aka, hoo ma e na kuleana o na kanaka maloko.

Pono nui ia ia ke uku no ka hooke holo ana i ka olelo, Penei,

W. L. Lee No ke rumi ame ke pui ana i ka olelo ma ka Muepua
 G. M. Robertson No ke kope ana i ka olelo koia
 J. Kekaulahas No ka palapala kii
 W. H. Smith No ka hana ana i ka la
 No ke kope ana i na olelo a ma hoi ke
 No ke ana ana i ka la
 No ke kope ana
 No ka hoo holo ana i ka olelo i ka la 1 o December 1853.

5 ✓

Ua hoo ko aku makou i keia kuleana mamuli o na Kanawai hou i hoo holo i ka la 19 o June M. H. 1852. i pili ana i na Honohiki

Helu 8525^B Julia Mapai Kauwa
 Part 4

Ua koi mai oia no kona Hiaina o Hainakoi i Waimalu, ma Ewa, ma ka Moku Puni o
 Oahu; no ka mea, ua loa ia ia ke kuleana iu aina no ke Mui Kamehameha III mai i ka mahalo aina ana
 i ka la 11 o Febemari M. H. 1848, a ua noho keakea oleia a hiki i keia manawa.

Oia ka makou e hoo ko mai no J. A. Kauwa, ke kuleana hoi i kona malalo iho o ke Ano Alodis.
 Ina e ukw mai oia iho ke Aupuni hupaha; alaila, ua kupaona ia ia ka Palapala Sila Alodis. Aka, ko maue
 ia ia na kuleana o na Kanaka maloko.

Pono nae ia ia ke ukw no ka hoo holo olelo ma ka hoo holo ana i ka olelo. Penei, -
 W. L. Lee No ka rumi ame ke pui ana i ka olelo ma ka Muepua.
 G. M. Robertson No ke kope ana i ka olelo koia
 J. Kekaulahas No ka palapala kii
 W. H. Smith No ka hana ana i ka la
 No ke kope ana i na olelo a ma hoi ke
 No ke ana ana i ka la
 No ke kope ana
 No ka hoo holo ana i ka olelo i ka la 1 o December 1853.

5 ✓

Ua hoo ko aku makou i keia kuleana mamuli o na Kanawai i hoo holo i ka la 19 o June M. H. 1852, i pili ana i na Honohiki.

Helu 8525^B Julia Mapai Kauwa
 Part 5.

Ua koi mai oia no kona Muepua o Honoumuni, ma Kona, ma ka Moku Puni o Molokai; no ka
 mea, ua loa ia ia keia aina no ka Mui Kamehameha III mai, i ka mahalo aina ana i ka la 11 o Febemari M.
 H. 1848, a ua noho keakea oleia a hiki i keia manawa.

Oia ka makou e hoo ko mai no J. A. Kauwa, ke kuleana hoi i kona malalo iho o ke Ano Alodis.
 Ina e ukw mai oia iho ke Aupuni hupaha; alaila, ua kupaona ia ia ka Palapala Sila Alodis. Aka, ko nae ma
 kuleana o na Kanaka maloko.

Pono nae ia ia ke ukw no ka hoo holo olelo ma ka hoo holo ana i ka olelo. Penei, -
 W. L. Lee No ka rumi ame ke pui ana i ka olelo ma ka Muepua
 G. M. Robertson No ke kope ana i ka olelo koia
 J. Kekaulahas No ka palapala kii
 W. H. Smith No ka hana ana i ka la
 No ke kope ana i na olelo a ma hoi ke
 No ke ana ana i ka la
 No ke kope ana
 No ka hoo holo ana i ka olelo i ka la 1 o December 1853.

5 ✓

Ua hoo ko aku makou i keia kuleana mamuli o na olelo Kanawai i hoo holo i ka la 19 o June M. H. 1852, i pili ana i na Honohiki

Helu 8525 B Julia Kapai Kuuwa

Part 6

Ua koi mai oia no kona Ahupuaa. Makila, ma Lahaina, ma ka Mokupuni o Maui; no ka mea, ua loa ia ia keia aina no ka Mui Hamehameha III mai i ka mahela aina ana i ka la 11 o Feberuari M. H. 1848, a ua noho keakea oleia a hiki i keia manawa.

Oia ka makou i hooko nei no J. A. Kuuwa, he kuleana hoi kona malalo iho o ke Ano Alodio. Ina e ukui mai oia i ke ke Aupuni hapaha; alaila, ua kupono ia ia ka Palapala Sita Alodio. Aka, koe nana ma kuleana o na kanaka maloko.

Pono nua ia ia ke ukui no ka hookoloholo ame ka hookolo ana i ka olelo, Penei,--

- W. L. Lee No ka rumi ame ke pui ana i ka olelo ma ka Kupepa.
- No ke kope ana i ka olelo koia
- G. M. Robertson No ka palapala kii
- J. Kekaulahao No ka hana ana i ka la
- J. H. Smith No ke kope ana i na olelo a ma hoi ke
- No ke ana ana i ka la
- No ke kope ana
- No ka hookolo ana i ka olelo i ka la 1 o Dekemba 1853.

5

Ua hooko aku makou i keia kuleana mamuli o na Hanawai i hookoloia i ka la 19 o June M. H. 1852, e pili ana i na Honohiki.

Helu 8525 B Julia Kapai Kuuwa

Part 7.

Ua koi mai oia no kona Ahupuaa. Haneo, ma Kona, ma ka Mokupuni o Maui; no ka mea, ua loa ia ia keia aina no ka Mui Hamehameha III mai i ka mahela aina ana i ka la 11 o Feberuari M. H. 1848; a ua noho keakea oleia a hiki i keia manawa.

Oia ka makou i hooko nei no J. A. Kuuwa, he kuleana hoi kona malalo iho o ke Ano Alodio. Ina e ukui mai oia i ke ke Aupuni hapaha; alaila, ua kupono ia ia ka Palapala Sita Alodio. Aka, koe nana ma kuleana o na kanaka maloko.

Pono nua ia ia ke ukui no ka hookoloholo ame ka hookolo ana i ka olelo, Penei,--

- W. L. Lee No ka rumi ame ke pui ana i ka olelo ma ka Kupepa.
- No ke kope ana i ka olelo koia
- G. M. Robertson No ka palapala kii
- J. Kekaulahao No ka hana ana i ka la
- J. H. Smith No ke kope ana i na olelo a ma hoi ke
- No ke ana ana i ka la
- No ke kope ana
- No ka hookolo ana i ka olelo i ka la 1 o Dekemba 1853.

5

Ua hooko aku makou i keia kuleana mamuli o na Hanawai i hookoloia i ka la 19 o June M. H. 1852, e pili ana i na Honohiki.

Helu 8524 B Peke

Part 1.

Ua koi mai oia no kona Ahupuaa. Kupeke, ma Kona, ma ka Mokupuni o Molokai; no ka mea, ua loa ia ia keia aina no ka Mui Hamehameha III mai i ka mahela aina ana i ka la 12 o Feberuari M. H. 1853; a ua noho keakea oleia a hiki i keia manawa.

Oia ka makou i hooko nei no Peke; he kuleana hoi kona malalo iho o ke Ano Alodio. Ina e ukui mai oia i ke ke Aupuni hapaha; alaila, ua kupono ia ia ka Palapala Sita Alodio. Aka, koe nana ma kuleana o na kanaka maloko.

Pono nua ia ia ke ukui no ka hookoloholo ame ka hookolo ana i ka olelo, Penei,--

W. L. Lee

G. M. Robertson
J. Kekaulaha
J. H. Smith

No ka rumi ame ke pui ana i ka olelo ma ka Nupepa
No ke kope ana i ka olelo koina
No ka palapala Sila kii
No ka hana ana i ka la
No ke kope ana i ka olelo ma hoike
No ke ana ana i ka la
No ke kope ana
No ka hooholo ana i ka olelo i ka la 2 o December 1853.

Ua hooko aku makou i keia kuleana mamuli o wa olelo o wa Hanawai i hooholoia i ka la 19 o June Mo. H. 1852, i pili ana i na Konohiki

See Page 416.

Helu 8524^B Puke

Part 2

Ua koi mai oia no kona Ahupuaa o Kapuwakua ma Pahaina, ma ka Moku o Mani, ma ka mea, ua loa ia ia keia aina no ka Moi Kamehameha III mai i ka mahelu aina ana i ka la 12 o Feberuari Mo. H. 1848, a ua noho keia olelo a hiki i keia manawa.

Oia ka makou i hooko nei no Puke, he kuleana hoi kona malalo iho o ke Ano Alodis. Ima e uku mai oia i ke ke Ahupuaa hapaha; alaila, ua kufono ia ia ka Palapala Sila Alodis. Aka, ke nae ia ia ma kuleana o ma keanaka maloko.

Pono nae ia ia ke uku no ka hookolokolo ame ka hooholo ana i ka olelo. Penei

W. L. Lee
G. M. Robertson
J. Kekaulaha
J. H. Smith

No ka rumi ame ke pui ana i ka olelo ma ka Nupepa
No ke kope ana i ka olelo koina
No ka palapala kii
No ka hana ana i ka la
No ke kope ana i na olelo a ma hoike
No ke ana ana i ka la
No ke kope ana
No ka hooholo ana i ka olelo i ka la 2 o December 1853.

Ua hooko aku makou i keia kuleana mamuli o wa Hanawai i hooholoia i ka la 19 o June Mo. H. 1852, i pili ana i na Konohiki.

Helu 8524^B Puke

Part 3

Ua koi mai oia no kona Ahupuaa o Kianaloli, ma Kona, ma ka Moku o Mani; no ka mea, ua loa ia ia keia aina no ka Moi Kamehameha III mai i ka mahelu aina ana i ka la 12 o Feberuari Mo. H. 1848, a ua noho keia olelo a hiki i keia manawa.

Oia ka makou i hooko nei no Puke, he kuleana hoi kona malalo iho o ke Ano Alodis. Ima e uku mai oia i ke ke Ahupuaa hapaha; alaila, ua kufono ia ia ka Palapala Sila Alodis. Aka, ke nae ia ia ma kuleana o ma keanaka maloko.

Pono nae ia ia ke uku no ka hookolokolo ame ka hooholo ana i ka olelo. Penei

W. L. Lee
G. M. Robertson
J. Kekaulaha
J. H. Smith

No ka rumi ame ke pui ana i ka olelo ma ka Nupepa
No ke kope ana i ka olelo koina
No ka palapala kii
No ka hana ana i ka la
No ke kope ana i na olelo a ma hoike
No ke ana ana i ka la
No ke kope ana
No ka hooholo ana i ka olelo i ka la 2 o December 1853.

Ua hooko aku makou i keia kuleana mamuli o wa olelo o wa Hanawai i hooholoia i ka la 19 o June Mo. H. 1852, i pili ana i na Konohiki.

Keleu 79FL Kekuanui

Ua koi mai oia no kona Aina aia ma Puunui i Honolulu, ma Kona, ma ke Moku-puni o Oahu; no ka mea, ua hooa ia ia keia aia no ~~Pohi~~ Kekaakaua mai a ua hooa ia ia Kekaakaua no Pohi mai, i ka wa no e ola ana o Pohi, a ua noho keakea oleia whiki i keia manawa.

Oia ka makou e hooke nei no Kekuanui; he kuleana hoi kona malalo iho o ke Aua Aloha. Ina e uku mai oia i ke ke Aupuni hapaha, aiaita, ua kupaia ia ia ke Palapala Sila Aloha.

Pono mai ia ia ke uku no ka hookelelele ame ka hookelelele ana i ka olelo. Penei,

- | | |
|-----------------|---|
| W. L. Lee | No ka rumi ame ke pui ana i ka olelo ma ka Mupapa |
| G. M. Robertson | No ke kope ana i ka olelo koina |
| J. Kekaulaha | No ka palapala kii |
| J. H. Smith | No ka hana ana i ka la 29 o Maraki 1852. |
| | No ke kope ana i ka olelo ma hookelelele. 1 aua |
| | No ke ana ana i ka la |
| | No ke kope ana |
| | No ka hookelelele ana i ka olelo i ka la 3 o December 1853. |

Eia na palapala. Inaia o J. P. Kalama

Aina ma Puunui, Honolulu, Kona, Oahu.

E Loi me Aua Pahale. E hoomaka ma ka pohaku i hooilani x ma Kahawai, ke kiki Hikina o keia aia, - E holo ana Aua 66° 30' Kom. 221 Panku pili ana me Aua; - Aua Hema 38° 30' Kom. 504 Panku pili ana me Aupuni a hiki i ka pohaku pua x, - Aua Hema 50° Hikina 454 Panku pili ana me Kalanikilo ame Aupuni a hiki i ka pohaku pua x ma ka palapala ma Kahawai. Aua holo pololei i ka 6 1/2 Kaulaha ma Kahawai a hiki i ka hiki i hoomaka i.

Eia ka Ali 1/10 Oka.

J. P. Kalama
Aua Aua

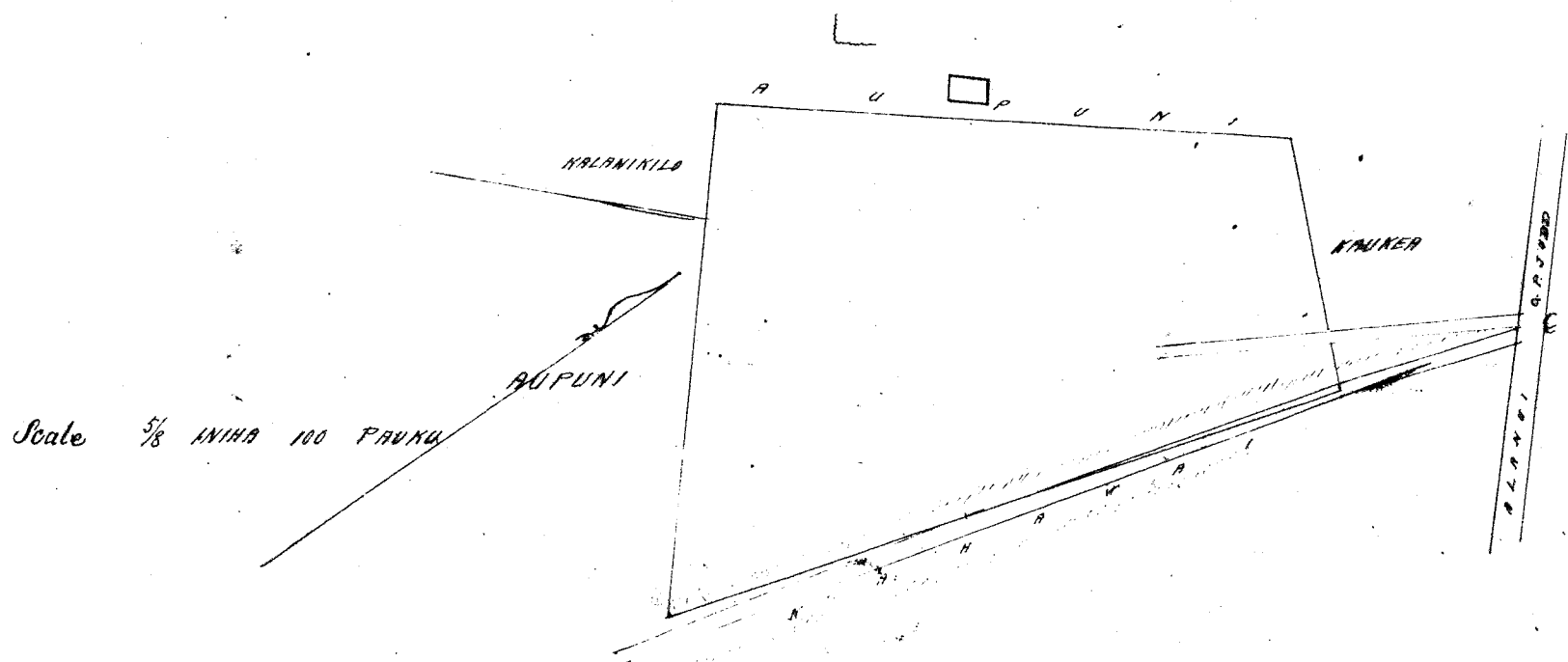

Keleu 2937 William Harbottle

Part 3.

Ua koi mai oia no kona Ahupuaa o Aua ma Kona, ma ke Moku-puni o Koolaha; no ka mea, ua hooa ia ia keia aia no kona makuakane mai o John Harbottle; aia hooa hoi ia John Harbottle no Kamihameha I mai, a ua noho keakea oleia whiki i keia manawa.

Oia ka makou e hooke nei no William Harbottle; he kuleana hoi kona malalo iho o ke Aua Aloha. Ina e uku mai oia i ke ke Aupuni hapaha, aiaita, ua kupaia ia ia ke Palapala Sila Aloha. Aka, kee mai ma kuleana o ma Kanaka maloko.

Pono mai ia ia ke uku no ka hookelelele ame ka hookelelele ana i ka olelo. Penei,

- | | |
|-----------------|--|
| W. L. Lee | No ka rumi ame ke pui ana i ka olelo ma ka Mupapa. |
| G. M. Robertson | No ke kope ana i ka olelo koina |
| J. Kekaulaha | No ka palapala kii |
| J. H. Smith | No ka hana ana i ka la 18 o Maraki 1851. |

No ke kope ana i ma olelo a ma hoike 1/3 aua
No ke ana ana i ka la
No ke kope ana
No ke hooholo ana i ka olelo i ka la 3 o December 1853.

5

Oia ma palena.

Ua hooke aku makou i keia kuleana mamuli o ma olelo o ma Hanawai i hooholoia ma ka la 19 o June M.H. 1852 i pili ana i ma kono hiki.

Helu 2937 William Hartottle

Part 7-

Ua koi mai oia no kona Ahupuaa o "Opama", ma Hamakualoa, ma ka Mokupuni o Maui, no ka mea, ua hoani ia ia keia aina no John Hartottle kona makuakane mai, a ua loaia hoi i kona makuakane no Hamakua I mai, a ua poho keakea oleia a hiki i keia manawa.

Oia ka makou i hooke meino William Hartottle, he kuleana hoi kona malalo iho o ke Ano Alodis. Ina e ukui mai oia i ke ke Auferuni hapaha; aiaia, ua kupaia ia ia ka palapala Sela Alodis. Aka, koe nae na kuleana o ma kumaka maloko.

W. L. Lee
G. M. Robertson
A. H. Kaulahao
J. H. Smith

No ka umi ame ke pua ana i ka olelo ma ka Kupaia
No ke kope ana i ka olelo koina
No ka palapala hii
No ka hana ana i ka la 18 o Aperila 1851.
No ke kope ana i ma olelo a ma hoike 1/3 aua
No ke ana ana i ka la
No ke kope ana
No ke hooholo ana i ka olelo i ka la 3 o December 1853.

5

Ua hooke aku makou i keia kuleana mamuli o ma olelo o ma Hanawai i hooholoia i ka la 19 o June M.H. 1852, i pili ana i ma kono hiki.

Helu 315 Pahia (no Kuakamauna)

From Page 106.

Ua koi mai oia no kona Pahale ma Naianaa ma Lahaina, ma ka Mokupuni o Maui; no ka mea, ua loaia ia ia keia wahi no

Oia ka makou i hooke meino Pahia a ia Kuakamauna, he kuleana hoi kona malalo iho o ke Ano Alodis. Ina e ukui mai oia i ke ke Auferuni hapaha; aiaia, ua kupaia ia ia ka palapala Sela Alodis.

W. L. Lee
G. M. Robertson
A. H. Kaulahao
J. H. Smith

No ka umi ame ke pua ana i ka olelo ma ka Kupaia
No ke kope ana i ka olelo koina
No ka palapala hii
No ka hana ana i ka la
No ke kope ana i ka olelo a ma hoike
No ke ana ana i ka la
No ke kope ana
No ke hooholo ana i ka olelo i ka la 30 o November 1852.

4

Oia ma palena

Anaia W. H. Kease.

Pahale ma ke ahupuaa o Naianaa, Lahaina, Maui

E hoomaka ana ma ke kipi Akaa Komohana ma ka Alanui Auferuni.

Ke	45° 30'	Ki	1 1/2	Kuul.	e pili ana i ke Alanui
Ke	44°	Ko	1 1/2		ka pahale o Kaeo
A	46°	Ko	1 1/2		o Hamakua
A	41° 15'	Ki	1		Bulawaia

A L A N U I

BALDWIN

O. O. 27

KAEU

KAMAKINI

1/2 INCH KAUAI = 1 INCH

Plot 285 Kamakini

From Page 278 Vol. 9.

Ua hoi mai oia no kana Pahale ma ka Ahupuaa o Waianae, ma Lahaina, ma ka Mokupuni o Maui; no ka mea, ua loa ia ia keia wahi no Kekauonohi mai, a, ua noho keakea oleia a kiki i keia manawa.

Oia ka makou e hooko nei no Kamakini; he kuleana hoi kona malalo iho o ke Ao Aloha. Ina e uku mai oia iho ke Ahupuaa hapaha; ataita, ua kupaia ia ia ka Palapala Sila Aloha.

Pono mai ia ia ke uku no ka hooko loko amu ka hooko ana i ka olelo Penei;—

- W. L. Lee No ka oumi amu ke paai ana i ka olelo ma ka Nupua.
- G. W. Robertson No ke kope ana i ka olelo koina
- J. M. Kaulahao No ka palapala kii
- H. Smith No ka hana ana i ka la
- No ke kope ana i na olelo a mai hoi
- No ke ana ana i ka la
- No ke kope ana
- No ka hooko ana i ka olelo i ka la 22 o Sepatemaha 1853.

Eia ma palena. Anai e H. A. Pease

Pahale, ma ka Ahupuaa o Waianae, Lahaina, Maui.

E hooko ana, ma ke kiki i ka wahi Komohana, ataita aku

He. 46'	Ki.	1 ⁵³ / ₁₀₀	Kaul.	e pili ana i ka pahale.	Kuakamanna
He. 46'	Ko.	1 ⁵⁵ / ₁₀₀	"	"	Kaeo
A. 40'	Ko.	1 ⁴² / ₁₀₀	"	"	do
A. 45'	Ki.	9 ⁶ / ₁₀₀	"	"	Baldwin
			E ili ana	24 Peka.	

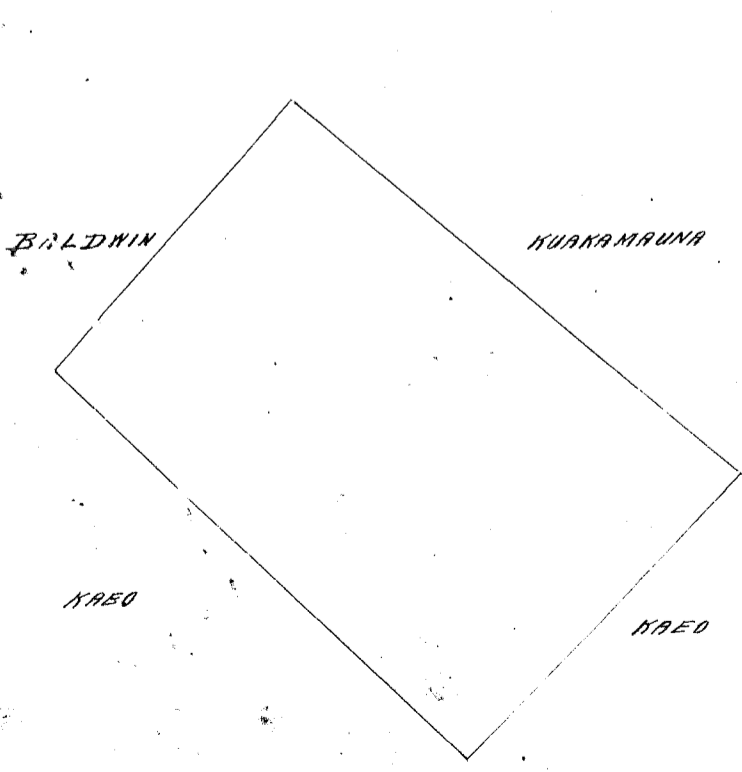

1/2 KAUAI = 1 INCH

Relu 7777 Kaiaino
From Page 228 Vol. 9.

Ua koi mai oia no kona mau wahi mau Kelauwa, mau Lahuaina, maika Pookupuni o Maui; no ka
mau, ua lousa ia ia keia mau wahi no Kaomi mau, ika a wa noho keia oleia a hiki i keia mau mau.

Oia ka mukou ehoko nei no Kaiaino; he kuleana hoi kona malalo iho o kei Ano Alodio. Ina e aku mai
oia iho ke Aupuni hapahau; aluho, ua kupuna ia ia ka Palapala lila Alodio.

- Pono mai ia ia ke ukou no ka hoooholo ana i ka olelo. Penei;—
- W. L. Lee No ka rumi ami ke pui ana i ka olelo maika Kapepa
 - No ke kope ana i ka olelo koina
 - G. M. Robertson No ka palapala hii
 - J. Hekaulahao No ka hana ana i ka ka
 - J. H. Smith No ke kope ana i ma olelo koina ma hoi ke
 - No ka ana ana i ka ka
 - No ke kope ana
 - No ka hoooholo ana i ka olelo i ka ka 9 o Kuaraki 1853.

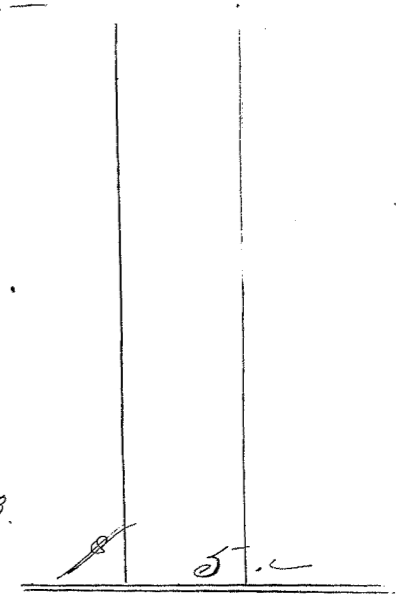

Eia ma palena. Anaina e W. P. Alexander.

Aia kona ana kuleana e waiho ana maika Ahupuaa o Kelauwa i Lahuaina, Maui.

Apana 1. E hoomaka ana ma ke kahi Aka Komohana, a e holo ana

He. 34 1/4	Hi. 0.92	Kaul. e pili ana maika Alanui
A. 52 1/2	Hi. 2.98	" " " " " " " " " " " "
A. 29	Hi. 1.23	" " " " " " " " " " " "
A. 47 3/4	Ko. 1.60	" " " " " " " " " " " "
He. 36	Ko. 3.98	" " " " " " " " " " " "
	Ka Ii	Kapihemui a hiki hoi i kahi i hoomaka ai.
		Ehua Poda 4 12 mau Poda.

Apana 2. E hoomaka ana ma ke kahi Aka Komohana, a e holo ana

A. 54	Hi. 0.86	Kaul. e pili ana maika Pikanalo
He. 54 20	Hi. 1.53	" " " " " " " " " " " "
He. 54 1/4	Ko. 0.28	" " " " " " " " " " " "
A. 42 1/4	Ko. 1.47	" " " " " " " " " " " "
	Ka Ii	Rev. T. E. Taylor
		Pikanalo i kahi i hoomaka ai
		13 mau Poda.

Apana 3. E hoomaka ana ma ke kahi Aka Komohana, a e holo ana

A. 45 3/4	Hi. 2.42	Kaul. e pili ana maika Mahikuli
He. 30 1/4	Hi. 0.23	" " " " " " " " " " " "
He. 44 1/4	Ko. 2.30	" " " " " " " " " " " "
A. 57 3/4	Ko. 0.29	" " " " " " " " " " " "
	Ka Ii	Kaimunui (Kaimunui) i kahi i hoomaka ai.
		11 mau Poda.

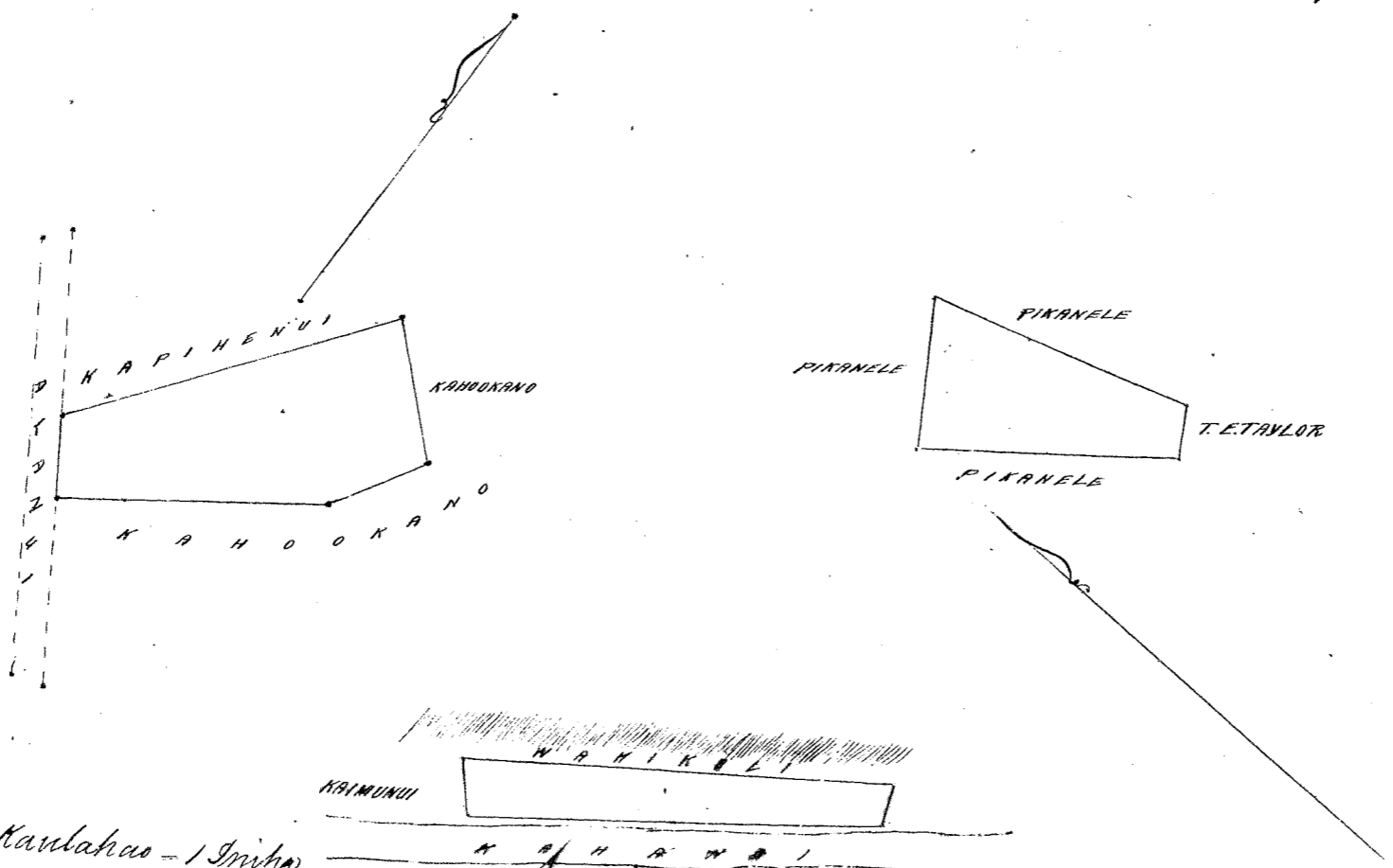

Apana 1. 2 Kaulahao - 1 Inika
" 2 1/2 " " "

Ua koi mai oia no kona aina ma Kainee, ma Tahaina, ma ka Mokupuni o Moai, no ka mea, ua loa ia ia keia aina no Kalapahala mai i ka wa o Hoapili, aua no ka keakea oia a hiki i keia manawa
 Oia ka maku a hoko nei no Naai, he kuleana hoi kona malalo iho oke Ano Alodio. Ina e ukw mai oia iho kei Ahupuni hapaha; alaila, ua kupo no ia i ka Palapala Sila Alodio.

Pono nae ia ia ke ukw no ka hoohelehele amu ka hoohele ana i ka olelo. Penei,
 W. L. Lee No ka rumi amu ke pai ana i ka olelo ma ka Napepa
 No ke kope ana i ka olelo koima
 G. M. Robertson No ka palapala kii
 J. Kekaulaha No ka hana ana i ka la
 J. H. Smith No ke kope ana i na olelo a na hoi ke
 No ka ana ana i ka la
 No ke kope ana
 No ka hoohele ana i ka olelo i ka la 6 o Decemaba 1853.

Eia na palena. Anaia e N. P. Alexander

Aia ka aina kuleana o Naai, e waiho ana ma ke Ahupuni o Kainee (o Kalapahala) ma Tahaina, Moai
 E hoomaka ana ma ke kahi o Hema Komohana, a e holo ana

A	30	Hi	1.40	Kaul. e pili ana me Paale		
He	86 1/4	Hi	1.21	"	Kulawahini	
A	58 1/4	Hi	1.88	"	Namaka	
A	79°	Hi	8.10	"	Kalapahala	
A	68 1/4	Hi	1.16	"	"	a hiki i ka auwai
A	3 1/2	Hi	1.87	"	ka pali	
A	12 3/4	Hi	1.74	"	"	
A	39 1/2	Hi	1.00	"	"	
He	15 1/4	Ko	0.37	"	"	
He	22 3/4	Ko	1.91	"	Nis	
He	7 3/4	Ko	2.53	"	"	
He	53 1/4	Ko	2.02	"	"	
He	68°	Ko	2.55	"	Polanui	
He	88 1/2	Ko	1.48	"	"	
He	64 1/4	Ko	1.69	"	"	
He	88 1/2	Ko	1.89	"	"	
He	75°	Ko	3.36	"	"	
A	80°	Ko	0.30	"	"	i kahi i hoomaka ai

Kei Ii 1 Eka, 1 Roda, 8 1/2 Roda.

N. P. Alexander
 Mea ma amu



Scale 2 chains to an Inch.

Helu 7715 Lot Kamehameha

Part 1

Ua koi mai oia no kona ~~ahupuaa~~ o Hanakao, ma Lahaina, Ma ka Moku o Maui; no ka mea, ua loa ia ia keia aino no ka Mui Kamehameha III mai i ka mahela aino ana i ka M. H. 1848, a ua noho keakea oia a hiki i keia manawa.

Oia ka makou e hoohe nei no Lot Kamehameha; he kuleana hoi kona maalalo iho o ke Ano Alodio. Ina e ukou mai oia i ke ke aupuni hapaha, alaila, ua kufono ia ia ka Palapala Sila Alodio. Aka, kou nae na kuleana o na kanaka maloko.

Pono na ia ia ke ukou no ka hoohe iho ana i ka olelo. Penei,-

- W. L. Lee No ka umi ame ke pui ana i ka olelo ma ka Nuipepa
- No ke kope ana i ka olelo koina
- G. M. Robertson No ka palapala kii
- A. Hekaulapaa No ka hana ana i ka la
- H. Smith No ke kope ana i na olelo a na hoihe
- No ke ana ana i ka la
- No ka kope ana
- No ka hoohe ana i ka olelo i ka la 6 o December 1853.

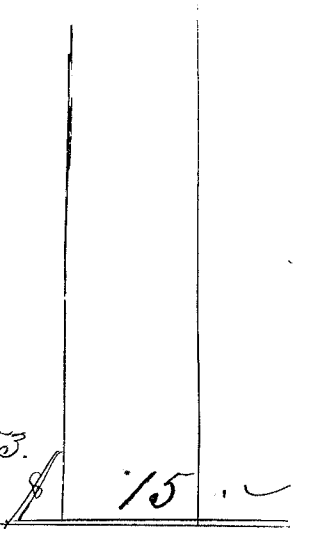

Eia na palena. Anaia i W. P. Alexander

1. He olelo hoakaka i ke ana ana i ke ahupuaa o "Hanakao," e waiho ana ma Lahaina, Maui. E hoomaka ana ma ke kiki Kema Kikina, a e holo ana

He	49 1/4	Ko	2, 48	Kaul	e pili ana me Kalimaoko
He	37 3/4	Ko	2, 13	"	"
He	45	Ko	5, 90	"	"
A	21 1/4	Ko	2, 10	"	Kainehe
A	34	Hi	2, 81	"	Puunoo
A	55 1/2	Ko	2, 23	"	"
A	50 3/4	Ko	2, 75	"	"
A	46 3/4	Hi	2, 89	"	"
A	47 1/2	Hi	3, 37	"	Kakalepo
He	50 3/4	Hi	4, 04	"	"
He	58	Hi	3, 19	"	" i kahi i hoomaka ai.

Ka Ili Elima Eka i Kanakolu kumamahiku Roda.

63 P. 1/2
 2-40
 75 1/2 P. 1/2
 3
 385387 P. 1/2

2 Chains to an Inch.

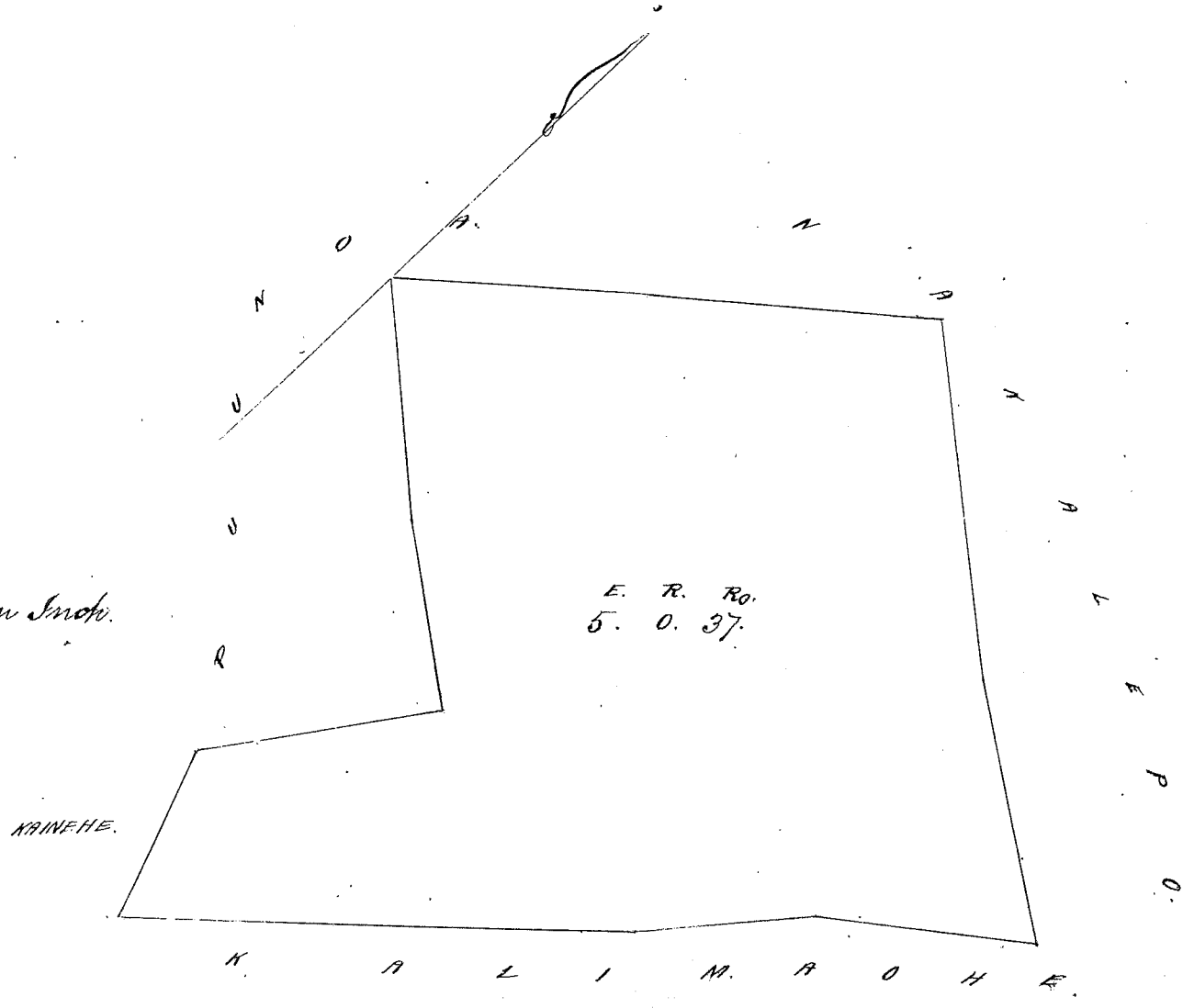

2. He olelo hoakaka i ke ana ana i ka Puka Kalo o ke Ahupuaa o "Hanakoo", aia ma ke awa o Hanaha, ma Lahaina, Maui.

E hoomaka ana ma ke kahi Hikiina ma ke Kahawai, a e holo ana

A	72 3/4	Ko	0.54	Kaul. e pili ana me Aipokepoko
A	68 3/4	Ko	1.49	" " "
He	79	Ko	7.14	" " Punaw
He	28 1/2	Ko	3.49	" " "
He	63 1/4	Ko	2.86	" " "
He	28°	Hi	0.44	" " a hiki i ke Kahawai
A	78 3/4	Hi	3.66	" " Kahawai
A	15 1/2	Hi	2.23	" " "
A	68 1/2	Hi	2.58	" " "
A	67	Hi	2.12	" " "
A	74	Hi	4.09	" " ame Punaw
A	21 1/4	Hi	1.24	" " a hiki i kahi i hoomaka

Ka Ili Elua Eka o Hoakahi Puka.

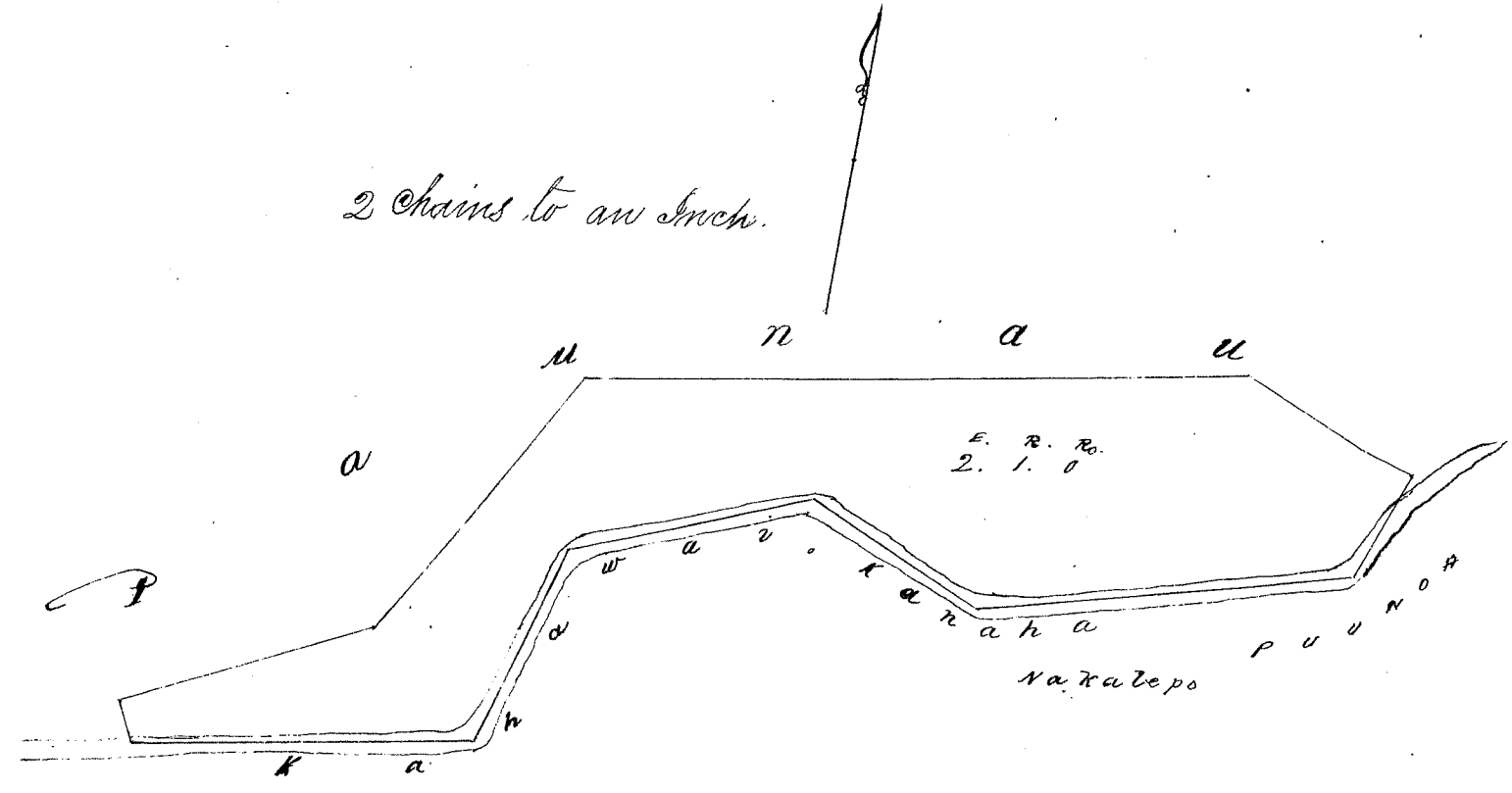

3. He olelo hoakaka i ke ana ana i ke Kula o ke Ahupuaa o "Hanakoo", ma Lahaina, Maui.

E hoomaka ana ma ke kahi Pohaku Kaulana i kapaia o "Pohakuohimamama" kahi i hunaia i "Lonokinau", a pukele i ka make ia "Kakaalaneo", E hoomaka ana ma laila a e holo ana

He	64 1/2	Ko	1.97	Kaul. e pili ana me Kahikuli
A	35 3/4	Ko	16.35	" " Kahakai i Hulua
A	54 1/4	Ko	20.86	" " "
A	51 1/2	Ko	34.76	" " i Makaiwa
A	8 3/4	Hi	45.09	" " "
A	36 3/4	Ko	14.36	" " i Kehaa
A	63	Hi	19.23	" " Honokawai
A	9 1/4	Ko	39.40	" " "
A	1 1/2	Hi	14.40	" " "
A	27	Hi	18.47	" " "
A	53 3/4	Hi	20.13	" " i ke awa o "Hawaiipapohaku"
He	73 3/4	Hi	11.45	" " "
He	39 1/2	Hi	8.89	" " "
He	82°	Hi	14.77	" " "
He	68°	Hi	13.37	" " "
He	75 1/4	Hi	4.08	" " "
He	77 1/2	Hi	16.55	" " "
He	84 1/2	Hi	11.64	" " i Kaluaolohi
A	89	Hi	14.50	" " i ka Hale o Kaleikini
He	82 1/2	Hi	19.97	" " i ka Papipi
He	88	Hi	15.79	" " "
He	89	Hi	18.11	" " ma kahi Alama

He	74°	Hi.	18.36	Kaul.	e pili me ^{ana} Honokawai ma kahi Alamui.
He	73 1/2	Hi	21.77	"	"
He	76 1/2	Hi	28.96	"	"
He	74°	Hi	29.30	"	"
He	79°	Hi	236.00	"	" a hiki iuka lilo -
Hema pono			33,40	"	" Kapunakua ke Kuahivi
A	56 1/2	Ko	80.00	"	" Kapunakua
He	72°	Ko	2.44	"	"
A	64 1/2	Ko	1.08	"	"
He	74 1/2	Ko	5.42	"	"
A	82°	Ko	4.81	"	"
A	84°	Ko	4.91	"	"
A	75°	Ko	27.55	"	"
A	1 1/2	Ko	0.77	"	"
A	77 1/2	Ko	21.34	"	"
A	72 1/2	Ko	31.63	"	"
A	77 1/2	Ko	39.00	"	"
A	67 1/4	Ko	27.00	"	"
A	57	Ko	19.73	"	" i "Ulapali."
A	76 3/4	Ko	18.09	"	"
He	84 1/2	Ko	35.58	"	" Kukuha
He	62 1/4	Ko	52.34	"	" & Mahikuli
He	3/4	Ko	15.45	"	" Mahikuli
He	8 3/4	Ko	51.89	"	"
He	2 1/4	Hi	10.34	"	"
He	77 1/2	Ko	92.53	"	" i kahi i hoomaka ai.

Ka Ili Ekolu Sausani ewalu haneri me Kanaha kumumano Eka.

Olelohoakaka. Aole i kopeia ke kii o keia Apiana ma ka mui loa, malaila, ma waitoria ma keia Butke ke kii, a wa kopeia ma ke ana wale no, - I.L. Naitili December 7, 1853. Mau Kakaulelo. - Wana arao 621

Helu ~~4467~~ ⁷⁷⁵³ Mahikona

Ua koi mai oia no kona Kapalua o ke Ahupuaa o Puuopaku 2, ma Hilo, ma ka Moku o Hawaii, no ka mea, ua loa ia ia keia aina no ke (Moi Kamehameha III) mai i ka mahalo aina ana i ka M. N. 1848, a ua noho ke keia olelo a hiki i keia manawa.

Oia ka makou e hoko nei no Mahikona, ke kuleana hoi kona, malalo iho o ke Ano Alodi. Aua e ukui mai oia i ke ke Aupuni hapahapa, a laia, ma kupaia ia ia ka Palapala Sila Alodi. Aka, koe ma e ma kuleana o ma kanaka maloko.

- Pono ma ia ia ke ukui no ka hoooholo ana i ke olelo. Puni, -
- W. L. Lee No ka rumi ame kupaia ana i ke olelo ma ka Mupapa
- G. M. Robertson No ke kope ana i ke olelo koia
- J. Stevanhous No ka palapala kii
- J. H. Smith No ka huna ana i ke la
- No ke kope ana i wa olelo a wa hiki
- No ka ana ana i ke la Uku o ke ana ana
- No ke kope ana
- No ka hoooholo ana i ke olelo i ke la 7 o December 1853.

Eia na palena. Anaia e. H. M. Lyman

\$ 30.00

*5 charges for P.L. costs in Awaia delivied leaving the pay ment of money to the Surveyor agreeable to consent of H. M. Lyman. This charge will be paid by H. M. Lyman to the Surveyor.

1/2 Ahupuaa o "Puuopaku" 2, Hilo, Hawaii.

E hoomaka keia ma kahakai, ma ka palena o keia aina & Puuopaku 1, ma
kahai pohaku e waiho ana mauka iki o ka ulukala, a e holo ma kahakai, - Ak. 18 Kom. 9, 00 kaul. a hiki i ke wai o
"Papaikou" (oia ke kahi Akau o keia aina) Alaila e hoi hou ma kahai i hoomaka i, a e holo ma ka palena o keia
aina & Puuopaku 1, - Kom 85 1/4 Kom. 7, 72 kaul, - Kom 86 3/4 Kom. 5, 88 kaul. - Kom 79 1/4 Kom. 6, 36 kaul. - Kom 83 1/2
Kom. 9, 90 kaul. a hiki i ke Alanui Ahupuaa, - Alaila Kom 88 1/2 Kom. 25, 54 kaul. - Alaila Kom. 73 1/4 Kom. 6, 03
kaul, - Kom 87 Kom. 8, 09 kaul, - Alaila Kom. 85 3/4 Kom. 7, 20 kaul. a hiki i ke kahi mauka o ka aina kuai o
Keahi (ma Puuopaku 1) e pili ana me keia, - Alaila e holo ma kahalo o keia aina, ma ka palena o keia Ahupuaa
hapulua o keia Ahupuaa, Ak. 12 Kom. 6, 52 kaul. a hiki i kahawai o Piikaa, - Alaila, e holo i ka maia
kahawai a hiki i kahakai i ke kahi Akau o keia aina. -

Maulalo o keia Ahupuaa aina 58 1/10 Eka.
H. M. Lyman
Surveyor

Olelohookaka. Aole i kopieia ke kii o keia Ahupuaa aina no ka mui loa a me ka lili loa o keia o keia
aina, nolaila, ua waihoia ma keia Buks ke kii no ke kono pono ole iloko o keia Buks, a ua kope waleia no ma
ke ana ana o keia aina.

December 7, 1853.

S. L. Kailiti
Mea Kakaulelo.

Helu 667 Kauaia

Ua hoi mai oia no kona Pahale ma Kahookane i Honolulu, ma Kona, ma ka Moku-
puni o Oahu, no ka mea, ua loaia ia keia wahi no kona mau kupuna mai a i kona mau mauka a hiki
ia Kauaia ma ka laka kaitamamine mai ka wai o Peleiholani, a ua noho keia oia a hiki i keia
manawa.

Oia ka makou i hooke me i no Kauaia, he kuleana hoi kona malalo iho o ke Ano Alalo
ma e ukia mai oia i ke ke Ahupuaa hapahu, alaila, ua kupono iaia ka Palapala Sila Alotio.

Pono naia ia ke ukia no ka hooholo ana me ka hooholo ana i ka olelo Puni.

- W. L. Lee No ka runi ame ke pai ana i ka olelo ma ka Muepa
- G. M. Robertson No ke kope ana i ka olelo koina
- S. Kekaulahe No ka palapala kii
- S. H. Smith No ka hana ana i ka la 31 o Ianuari 1848.
- No ke kope ana i ma olelo a nuhoike
- No ke ana ana i ka la 5 o December 1853.
- No ke kope ana
- No ka hooholo ana i ka olelo i ka la 7 o December 1853.

Eia na palena Aiaia e S. P. Kalama.

Aina ma Kahookane Nuuanu Honolulu, Oahu.

Pahale. E hoomaka ma ke kahi Komohana o keia Pahale, e pili ana me ke Alanui
Nuuanu ame ka aina o Kumukoa, i lilo i ke Ahupuaa, - A e holo Kom. 48 Hikiina 195 Panku pili me
Kumukoa no ke Ahupuaa a hiki i ke kahi Kom. 57 Hikiina 240 Panku pili ana me ke
Hoopanaia no ke Ahupuaa a hiki i ke kahi Hikiina o keia aina, - Alaila Kom. 48 Kom. 309 Panku pili
ana me ke Alanui no ke Ahupuaa a hiki i ke Alanui Nuuanu, - Alaila Kom. 50 Kom. 236 Panku
pili ana me ka lili Kom. o ke Alanui Nuuanu a hiki i ke hoomaka ana.

Eia ka Ili 1/10 Eka.

(E nawai ma keia Aua 320 i ke kii)

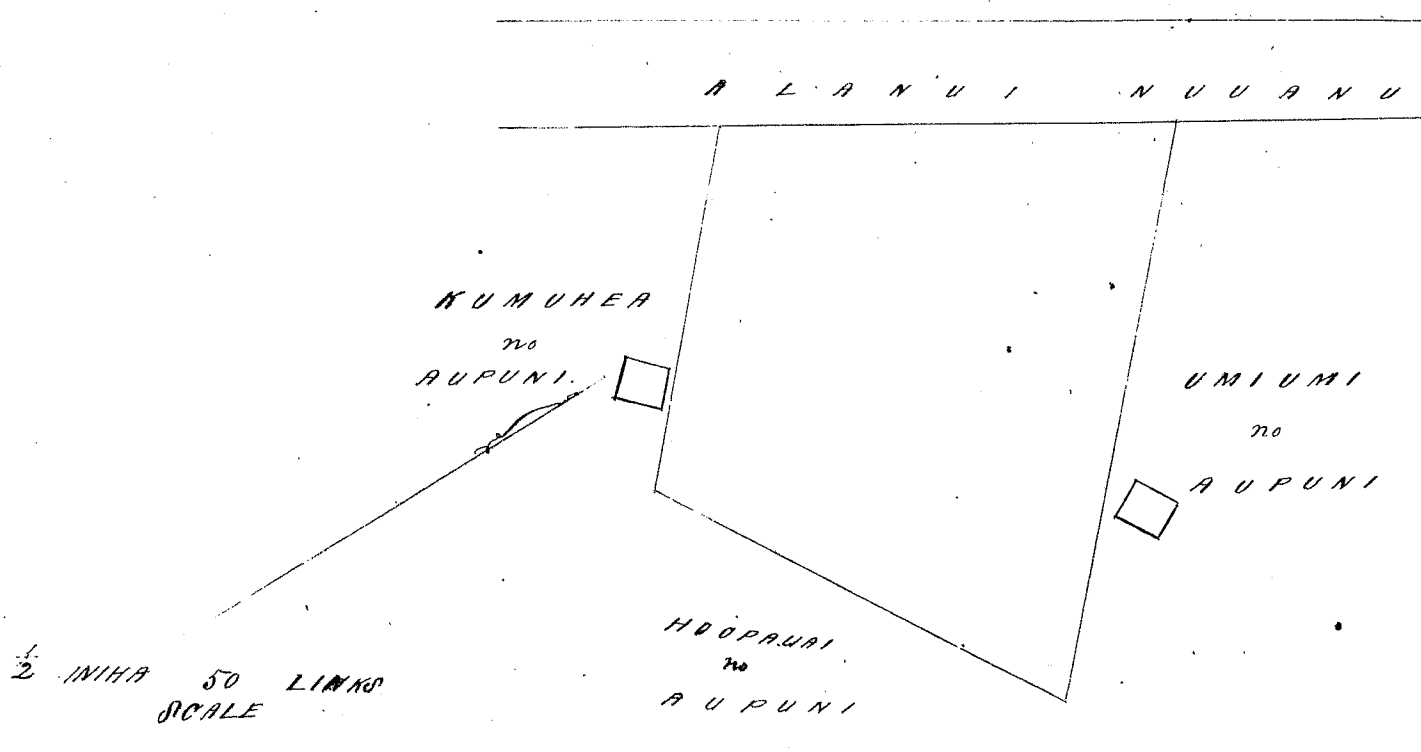

Sele 2937 William Harbottle
Part 6

Ua koi mai oia no kona Aiaiaia. Hanapouli iloko o Waipio, ma Ewa, ma ka Moku o Oahu, no ka mea, ua loa ia ia keia aiaia no John Harbottle mai kona makuakane, a ua loa hoi ia John Harbottle no ka Mui Kamehameha I, a ua noho keakea oleia a hiki i keia manawa.

Cia ka makou e hooko nei no William Harbottle; he kuleana hoi kona malalo iho o ke ano Alodio. Ina e ukui mai oia i ke ke Aupuni hapaha; alaila, ua kuponu ia ia ke Palapala Sila Alodio Aka, kee mai ia ia ke kuleana o waikanaka maloko.

Pono mai ia ia ke ukui no ka hookoloholo ame ka hookolo ana i ka olelo.

- W. L. Lee No ka umu ame ke pui ana i ka olelo ma ka Kupepa.
- G. M. Robertson No ke kope ana i ka olelo koina
- J. Hekaulaha No ka palapala kii
- J. H. Smith No ka hana ana i ka la
- No ke kope ana i mai olelo a ma hoi ke
- No ke ana ana i ka la
- No ke kope ana
- No ka hookolo ana i ka olelo i ka la 8 o Dekemaba 1853.

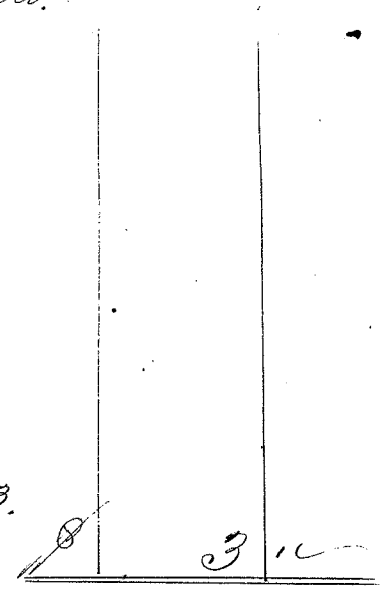

Eia mai palena. Anania e A. Bishop

He ana o kona aiaia ma Hanapouli, Waipio, Ewa, Oahu.
Apana aiaia, He Loi Koole. E hoomaka ma ke kii Aka e hele ana Ham 45 1/2 Kom. 153 kaul. ma ke Ahupuaa, - Malaila aku Ham 53 1/2 Heik. 1.50 kaul. ma ke Ahupuaa, - Malaila aku Aka 49 1/2 Heik. 1.00 kaul. ma ke kuleana o Kaholohana. - Malaila aku Ak. 33 1/2 Kom. 153 kaul. a hiki i ka hoomaka ana.

He 20 kaulaha huihana

A. Bishop
Mea Anania.

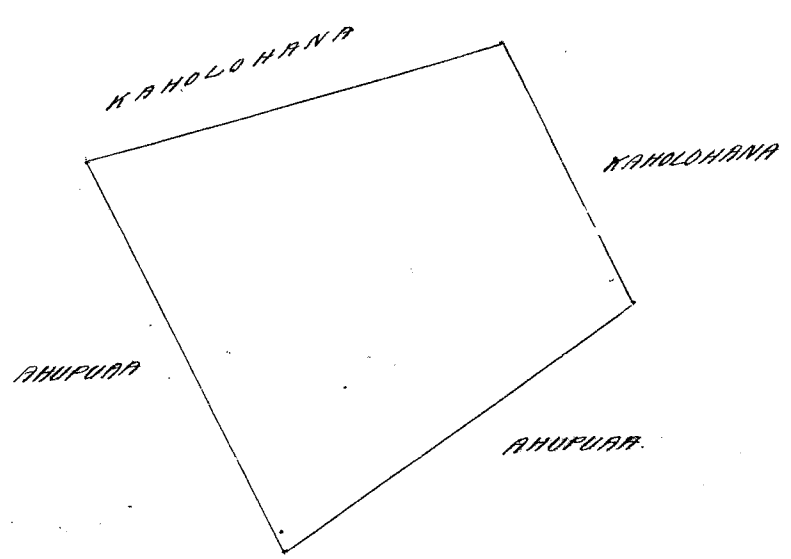

Heleu 7137 Kahookanohano

Ua koi mai oia no kona Iiaina o Onouli iloko o Kaihale, ma Koolau-poko, ma ka Mokupuni o Oahu, no ka mea, ua loa ia ia keia wahi no ka Mwi Kamehameha III mai i ka mahela aina ana i ka M. H. 1843 a ua noho keakea oleia a hiki i keia manawa.

Oia ka makou e hooko nei no Kahookanohano, he kuleana hoi koma malalo iho o ke Ano Alodio. Ina e ukui mai oia i ke Aupuni hapaha, alaila, ua kupaia ia ia ka Palapala Sila Alodio. Aka, koe mae na kuleana o na kanaka maloko.

Pono mai ia ia ke ukui no ka hookoloholo ame ka hookolo ana i ka olelo. Penei,

- | | |
|-----------------|---|
| W. L. Lee | No ka rumi ame ke pui ana i ka olelo ma ka Nupupa |
| G. M. Robertson | No ke kope ana i ka olelo koma |
| J. Kekaulaha | No ka palapala kii |
| C. H. Smith | No ka hana ana i ka la |
| | No ke kope ana i na olelo a ma hoike |
| | No ke ana ana i ka la 5 o Mei 1853. |
| | No ke kope ana |
| | No ka hookolo ana i ka olelo kii ka la 8 o December 1853. |

Eia na palena. Anai e William Webster

Claim 7137 Kahookanohano

Description of the boundary of the Land of Onouli in Kaihale, Koolau-poko, Oahu, belonging to the heirs of Kahookanohano

Commencing at the south angle on the shore the boundary runs along Kaihale N. 68° 30' W. 87 feet, S. 61° 35' W. 168 feet to side of Kula land, thence along an old water course S. 11° 10' E. 208 feet, S. 22° 15' E. 250 feet, S. 5° 0' E. 450 feet, thence along Poropupe S. 85° 2' W. 250 feet, S. 68° 58' W. 790 feet, S. 76° 30' W. 409 feet, thence along Footpath, S. 61° 50' W. 300 feet, S. 50° 20' W. 289 feet, thence along Kamiloa, N. 82° 38' W. 182 feet, N. 58° 8' W. 596 feet, thence along Kapuakea, S. 75° 7' W. 977 feet, thence along Kaihale, N. 60° 14' E. 430 feet to Kukui tree marked "B", thence N. 72° 6' E. 488 feet, N. 67° 30' E. along ridge 991 feet, thence N. 61° 2' E. 400 feet, N. 74° 32' E. 719 feet, N. 46° 20' E. 137 feet, N. 7° 8' E. 165 feet, N. 63° 15' E. 87 feet, thence through swampy land, N. 59° 45' E. 1201 feet, thence along side of Stream N. 72° 0' E. 405 feet, N. 62° 43' E. 156 feet to point at makai south corner of bridge, thence southerly along sea coast to commencement 550 feet on a straight line

Area 93 Acres.

Kaalaia 5th May 1853.

Wm Webster
Surveyor

Olelohoakaka. Aole i kopeia iloko o keia Kuke ke Kii no ka mui loa, a ua kopeia ma kei ana wale no, oia keia i hoikeia mamua nei.

Dec. 8, 1853.

J. L. Naitili
Mea Kakanohole.

Heleu 5524 L. Konia

Part 6.

Ua koi mai oia no kona Iiaina o Kamaohi iloko o ke Kapa Kamaohana o Kalanua ma Ewa, ma ka Mokupuni o Oahu, no ka mea, ua loa ia ia keia aina no ka Mwi Kamehameha III mai i ka mahela aina ana i ka M. H. 1848, a ua noho keakea oleia a hiki i keia manawa.

Oia ka makou e hooko nei no L. Konia, he kuleana hoi koma malalo iho o ke Ano Alodio. Ina e ukui mai oia i ke Aupuni hapaha, alaila, ua kupaia ia ia ka Palapala Sila Alodio. Aka, koe mae na kuleana o na kanaka maloko.

Pono mae ia ia ke ukui no ka hookoloholo ame ka hookolo ana i ka olelo. Penei,

- | | |
|-----------------|---|
| W. L. Lee | No ka rumi ame ke pui ana i ka olelo ma ka Nupupa |
| G. M. Robertson | No ke kope ana i ka olelo koma |
| J. Kekaulaha | No ka palapala kii |
| C. H. Smith | No ka hana ana i ka la |

No ke kope ana i na olelo a ma hoike.

No ke ana ana i ka la

No ka kope ana

No ka hooholo ana i ka olelo ~~hoiwa~~ i ka la 8 December 1853

Eia na pulena.

Anaia e A. Bishop

8 5

He ana no ka Iwaima o Kuamohi, Kalanoo, ^{Ewa} Oahu.

E hoomaka ma ka hiki kahakai, ka hi i pili ana me Iwaima, e hele ana Iwaima 69 Hiki i 7, 16 kē. ana ka hiki a ke kuapa loko. Malaila aku Iwaima 53 Hiki i 5, 7 kē. ma ka kuapa. Malaila aku Iwaima 65 Hiki i 1, 75 kē. ma kuapa. Malaila aku Iwaima 86 1/2 Hiki i 2, 28 kē. ma kuapa. Malaila aku Iwaima 81 Hiki 4, 80 kē. Malaila aku Iwaima 31 Hiki i 7, 9 kē. ma ka hiki muliwaia. Malaila aku Iwaima 42 Hiki i 6, 24 kē. ma ka pulena me Iwaima. Malaila aku Iwaima 51 Hiki i 5, 62 kē. ma ka Iwaima. Malaila aku Iwaima 52 1/2 Hiki i 4, 25 kē. Malaila aku Iwaima 66 Hiki i 4, 27 kē. a hiki i ka hawai Malaila aku Iwaima 20 Iwaima i 2, 56 kē. ma ka pulena me Iwaima (Iwaima Bill) Malaila aku Iwaima 50 Hiki i 0, 73 kē. Malaila aku Iwaima 33 Iwaima i 1, 00 kē. Malaila aku Iwaima 50 Hiki i 5, 6 kē. ma ka pulena me Iwaima. Malaila aku Iwaima 51 1/2 Hiki i 4, 96 kē. a ke hawai. Malaila aku Iwaima i 1, 20 kē. Malaila aku Iwaima 59 1/2 Hiki i 2, 70 kē. Malaila aku Iwaima 41 1/2 Hiki i 8, 00 kē. Malaila aku Iwaima 13 Hiki i 6, 50 kē. ma ka hawai. Malaila aku Iwaima 29 Hiki i 2, 00 kē. Malaila aku Iwaima 64 Hiki i 6, 71 kē. a ke pali ma ka ala Aniani. Malaila aku Iwaima 28 Hiki i 4, 50 kē. Malaila aku Iwaima 34 Hiki i 10, 00 kē. Malaila aku Iwaima 25 Hiki i 19, 00 kē. Malaila aku Iwaima 41 Iwaima i 6, 00 kē. i 19 kē. Malaila aku Iwaima 44 Iwaima i 6, 00 kē. a hiki i ka pali. Malaila aku Iwaima 58 Hiki i 22, 00 kē. ma ka hawai. Malaila aku Iwaima 67 Hiki i 33, 00 kē. ma ka hawai. Malaila aku Iwaima 25 Hiki i 17, 00 kē. Malaila aku Iwaima 59 Hiki i 5, 16 kē. Malaila aku Iwaima 54 1/2 Hiki i 13, 00 kē. Malaila aku Iwaima 55 Hiki i 22, 00 kē. ma ka hawai a hiki i ka hawai. Malaila aku Iwaima 45 Iwaima i 12, 00 kē. ma ka hawai a hiki i ka pulena o Iwaima. Malaila aku Iwaima 68 Iwaima i 22, 00 kē. ma ka pulena o Iwaima. Malaila aku Iwaima iho i ka hawai Iwaima 42 Iwaima i 102, kē. ma ka hawai. Malaila aku Iwaima ka pali Iwaima 78 Iwaima i 15, 00 kē. ma ka pulena o Iwaima. Malaila aku Iwaima 68 Iwaima i 3, 00 kē. Malaila aku Iwaima 53 Iwaima i 21, 00 kē. Malaila aku Iwaima 5 1/2 Iwaima i 33, 00 kē. ma ka pali. Malaila aku Iwaima 36 Iwaima i 21, 00 kē. ma ka pulena o Iwaima. Malaila aku Iwaima Iwaima i 32, kē. Malaila aku Iwaima 20 Iwaima i 22, 00 kē. Malaila aku Iwaima 11 Iwaima i 12, 00 kē. Malaila aku Iwaima 35 Iwaima i 5, 00 kē. ma ka pulena o Iwaima a hiki i ka hoomaka ana Iwaima 1603 ma Eka oia ana.

A. Bishop
Mea Ana

Olelo o ka hiki. Aole i kopeia i ka olelo o ka hiki i ka hiki, ma ka hiki a ke ana i ka hiki ma ka hiki.

Dec. 8, 1853.

J. L. Naititi.
Mea Kakanoho

Hele 1012 Unama.

Ma hiki mai oia ma ka hiki ma ka hiki. Eia i ka hiki oia ma ka hiki. Ma hiki mai oia ma ka hiki ma ka hiki. Ma hiki mai oia ma ka hiki ma ka hiki.

Eia na pulena. Eia na pulena. Eia na pulena. Eia na pulena. Eia na pulena.

- W. L. Lee
- G. M. Robertson
- J. M. Kaulaha
- J. M. Smith

No ka hiki a ke ana i ka hiki ma ka hiki. No ka hiki a ke ana i ka hiki ma ka hiki. No ka hiki a ke ana i ka hiki ma ka hiki. No ka hiki a ke ana i ka hiki ma ka hiki. No ka hiki a ke ana i ka hiki ma ka hiki. No ka hiki a ke ana i ka hiki ma ka hiki. No ka hiki a ke ana i ka hiki ma ka hiki. No ka hiki a ke ana i ka hiki ma ka hiki. No ka hiki a ke ana i ka hiki ma ka hiki. No ka hiki a ke ana i ka hiki ma ka hiki.

Dec 8, 1853

Aina ma Kalawela, Honolulu, Oahu.

1. Lei. E hoomaka ma ke piki Kauhaha o keia Lei, e pili ana me ke Ala Ololi ma Kalawela a me kona lei. E holo ana Kona 54° Hikina 81 Fanku, - Kona 60° Hikina 49 Fanku. pili ana me ke Alanui Kalawela, - alaila Kona 6°30' Hikina 81 Fanku. pili ana me ka lei o Kalawela, - alaila Kona 59° Kona 89 Fanku. pili me ka lei o Livingston, - alaila Kona 35°45' Kona 67 Fanku pili ana me ka lei o Kalawela a hiki i ka hoomaka ana. Eia ka Ili 94 Amara.

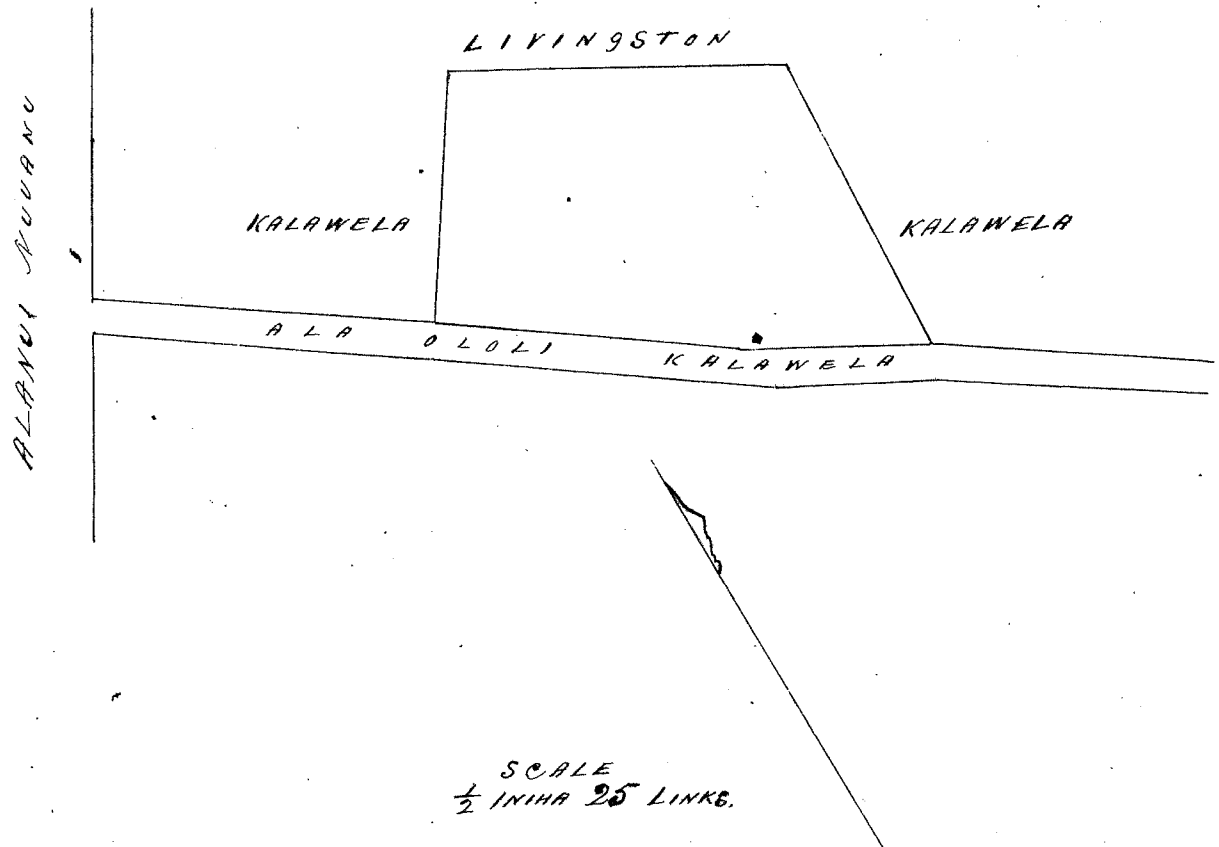

Uku 8645 Sept.

Ua hoi mai oia ma kona mau wahi ma Palikea, Nuuanu, Honolulu. Kona. Moku oia ma ka mea ua hoo ia ia keia mau wahi ma. M. Kekuanawa mai mahope iho o ka maki ana o Kona i ka M. A. 1840. a ua wahi keakea oia a hiki i keia manawa.

Oia ka maki e hooke me me Sept, ke hooana hoi kona malalo iho o ke ala Olodis. Ema uku mai oia i ke ke Aupuni hapaha; alaila ua kupuna ka Palapala Sila Olodis.

Pono mai ia ia ke uku ma ka hooke hooke a me ka hooke ana i ka olelo Pono.

W. L. Lee No ka sumi a me ke pai ana i ka olelo ma ka Mupipi.

G. M. Robertson No ke kope ana i ka olelo kona
No ka palapala hii.

A. Kekaulaha No ka hana ana i ka la 13 o Mei 1851.

P. H. Smith No ke kope ana i ma olelo a ma hiki 1/4 Awar.

No ke ana ana i ka la 7 o Dekemaba 1853.

No ke kope ana

No ka hooke ana i ka olelo i keia la 9 o Dekemaba 1853

4. 00

Eia ma palena. Aina o S. P. Kalama.

Aina ma Palikea, Nuuanu, Honolulu, Oahu.

1. 89
1. 14
1. 70
Ap. 1. 2. Lei. E hoomaka ma ke piki Hikina o keia Apana aia, e pili ana me ka palena o Kapahe, a me Kapahe, - a e holo Kona 71° Kona 51 Fanku - Kona 18° Kona 19 Fanku, - Kona 68° Kona 36 Fanku, Kona 32° Kona 31 Fanku, - a me Kona Kona 10 Fanku, - Kona 27°45' Kona 122 Fanku pili me Kapahe, Lahaina, Kapahe, - alaila Kona 77° Hikina 100 Fanku. pili me Kapahe alaila Kona 28° Hikina 123 Fanku pili me ^{Kapahe} a hiki i ka hoomaka ana. Eia ka Ili 14/100 Eka.

Ap. 2. Aina kolo me Kapahe. E hoomaka ma ke piki Hikina o keia Apana aia, e pili ana me ke Alanui Palikea, - E holo ana Kona 43° Kona 319 Fanku. pili me ke ala Ololi, - alaila Kona 51°30' Kona 557 Fanku pili me Aupuni, - alaila Kona 21°30' Hikina 170 Fanku, - Kona 52°30' Hikina 134 Fanku. pili me Kapahe, a hiki i ke piki Kona; makai o ka lei Aupuni, - alaila Kona 55° Hikina 229 Fanku a hiki i ka pahaku a me Kona 54°30' Hikina 368 Fanku pili ana me Aupuni a hiki i ka hoomaka ana. Eia ka Ili 17/100 Eka.

Pono ka Ili no Sept wale no 1. 84/100 Eka.

Eia kekahi, Na hokomū ike o ka Apana 2 o Kepu, ke Kāhaka Apana 3 a me ke Holoua, Apana 3. Ie mau hūlana ua hoko muaia, aka, ua hōe no ia mau Apana no lāua, a ua hūlūia ka Kī o Kepu wale no 17000 Eka. Ua hōkōwalewale na lāua ike ua mau hūlana nei, a penei ke lāua palina.

Helu 2556 Kāhaka - Apana 3 ma Palika. 1 Loi Chomaka ma ke kīhi Akau. E holo Kema 29° Kom: 91 Pautu pili me Kepu. Kema 54° Kikina. 78 Pautu pili me Kepu. Akau 30° Kikina 93 Pautu pili me Kepu. Akau 54° Kom: 82 Pautu pili me Kepu a hiki i ka hōmaka ana. Ka Kī 7000 Eka. A. F. Turner. Iana.

Helu 1139 Holoua - Apana 3 ma Palika. He Loi Chomaka ma ke kīhi Akau. E holo ana Kema 63° 45' Kikina 73 Pautu me Kepu. Kema 41° 15' Kom: 107 Pautu me ke Palā. Akau 52° 15' Kom: 66 Pautu me Kepu. Akau 38° 15' Kikina 98 Pautu me Kapahi a hiki i ka hōmaka ana. 80 Anana. A. G. Thurston. Iana.

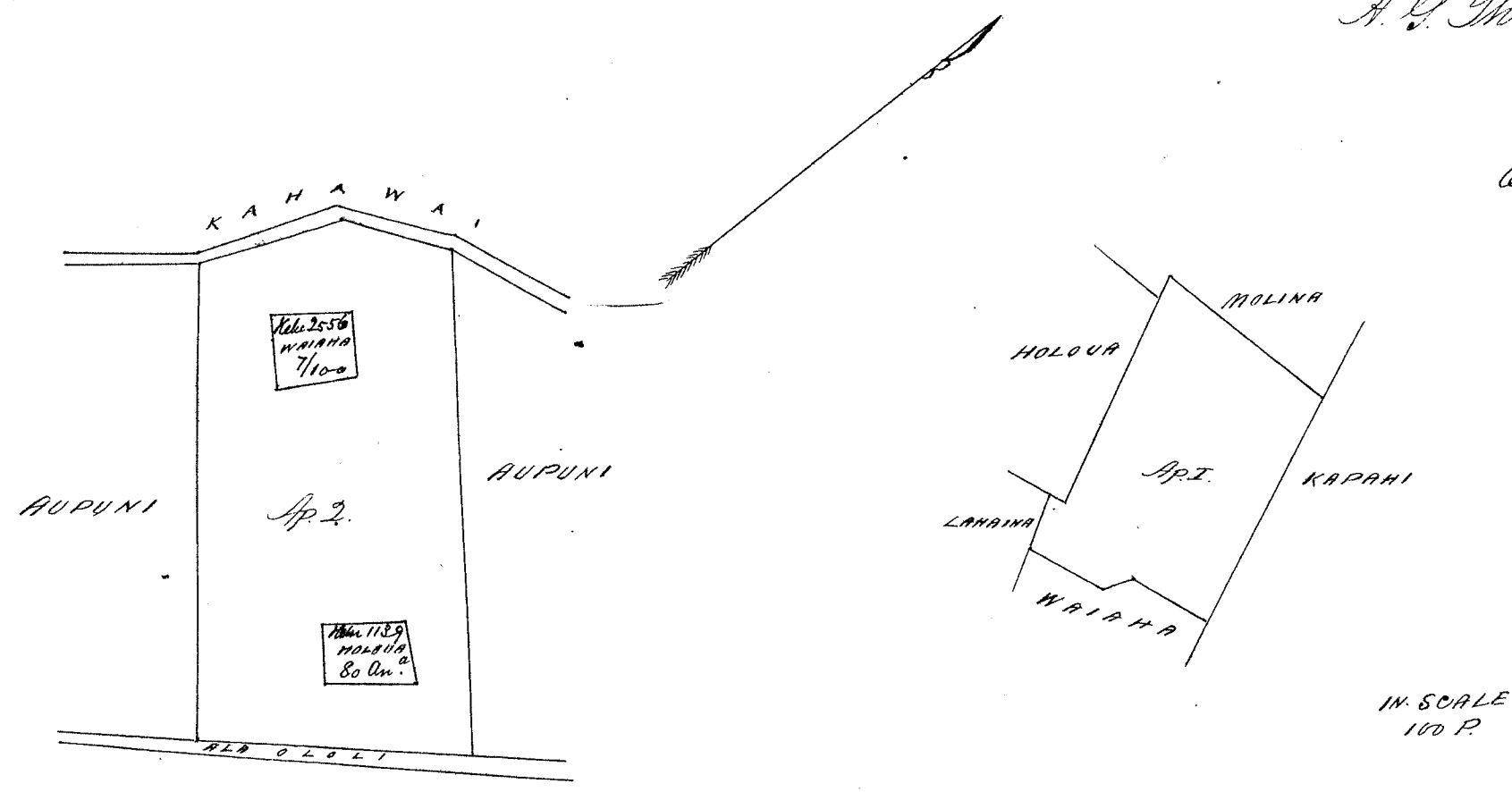

E D 1.84 E
Ces of .80
170

Helu 45 FL Kāwiliako

Ua kōi mai oia no kona wahī ma Pūnāpū Lēle o Niipaiipai, Nuuanu i Honolulu, ma Kona, ma Kāwiliako Mokupuni o Oahu, no ka mea, ua lāua ikeia wahī no Kāwiliako ame Kāwiliako i ka M. H. 1845, a ua lāua hoi ia Kāwiliako ame Kāwiliako i ka M. H. 1856 no Kāwiliako, ma ke Kāwiliako, a ua nōho keakea oleia a hiki i keia manawa.

Oia ka mākau i hoko nei o Kāwiliako, he kuleuna hoi kona mālalā iho o ke Aunō Aloha. Iana e ikeia mai oia i ke ke Aupuni hapaha, a lāua, ua kōpōno ia ia ke Palapala Lāua Aloha.

- | | |
|-----------------|---|
| W. L. Lee | No ka rumi ame ke pāi ana i ke olelo ma ke Niipai |
| G. M. Robertson | No ke kōpō ana i ke olelo (kōma) |
| J. K. Kaulaha | No ke palapala kōi |
| J. H. Smith | No ka hana ana i ke lāua 21 o Januāri 1852, |
| | No ke kōpō ana i ma olelo a wa hōke |
| | No ke ana ana i ke lāua 15 o Apriila 1852. |
| | No ke kōpō ana |
| | No ke hōhō ana i ke olelo i ke lāua 12 o December 1853. |

Eia na palena. Anāia e S. P. Kalamā

Pūnāpū Lēle o Niipaiipai, Nuuanu, Honolulu, Kona, Oahu. Kēla o Loi. E hōmaka ma ke kīhi Akau o keia aina ma ke pōhaku ihouilonaia x ma ke papohaku o Dr. Poole. E holo ana Kema 19° Kom: 181 Pautu ma ke papohaku lāua Kema o ke Alani Nuuanu. Kāwiliako Kema 42° Kikina 194 Pautu pili me ke aina o Luani no P. C. Kōllie. Akau Akau 58° Kikina 42 Pautu Akau 42° Kikina 142 Pautu pili me ke aina o Kūapū a hiki i ke hōilona x māwaho o ka pō o Dr. Poole

3

Alaia Akau 48° 30' Kom. 276 Pautu mawaho o ka papahaku o Dr. Rooke a hiki i ka hoomaka ana
Eia ka Ii 500 Anana

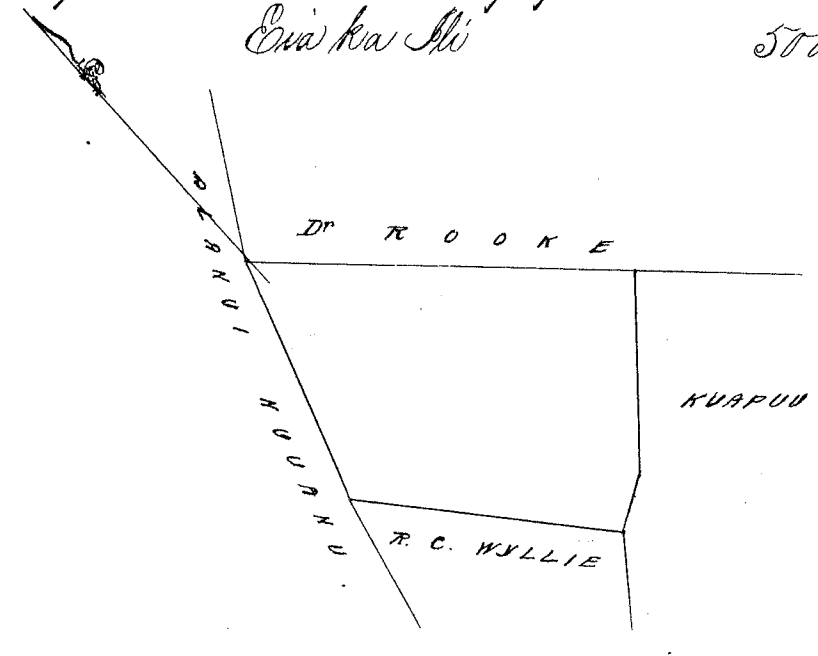

3/4 INCH 100 FATHOM SCALE

Helu 20 FL John N. D. Paalua

Ua koi mai oia no hono wahi ma Kamaui i Honolulu, ma Kona, ma ka Mokupuni o Oahu; no ka mea, ua haa ia ia keia wahi no Kona me M. Kekuanana mai i ka M. H. 1844, aka, ua haa mua keia aina ia Naha ke kaikuaana o J. N. D. Paalua no J. A. Kukanini mai i ka M. H. 1831, a hoi ia i Hawaii, ili ka aina ia Kaule ko lona mawakane, a make ia ili maika aina ia J. N. D. Paalua, a ua noho keakea oleia a hiki i keia manawa.

Oia ka makou e hoko nei no J. N. D. Paalua, he kuleanahorikona, malalo iho o ke Ano Aloha. Ima e ukw mai oia i ke ke Aupuni hapaha, aiaia, wa kupaia ia ia ka Palapala lilo Aloha.

Ua naia ia ke ukw ma ka hooholo ana i ka olelo. Penei

- W. L. Lee
- G. M. Robertson
- J. Kekaulahas
- J. N. Smith

- No ka oomi ame kepaia ana i ka olelo ma ka Muepa
- No ke kope ana i ka olelo koina
- No ka palapala kii
- No ka huna ana i ka la 24 o Dekemaba 1851.
- No ke kope ana i ma olelo a wa hiki 7 aoo
- No ke tina ana i ka la 27 o Aperila 1852.
- No ke kope ana
- No ka hooholo ana i ka olelo i ka la 12 o September 1853.

Eia wa palena. Anai e J. P. Kalama

Aina ma Kamaui, Honolulu, Kona, Oahu.
3 Loni E hoomaka ma ke kahi Kema o keia aina, ma ka lili Kema o ka auwai Kamaui e pili ana me ka Ii "Kamaui". E holo ana Akau 3° 45' Kikina 117 Pautu, Akau 14° Kikina 214 Pautu me Akau 26° 30' Kikina 87 Pautu ma ka lili Kema o ka auwai Kamaui a hiki i ka auwai o Oahu, Akau Akau 50° 45' Kom. 186 Pautu ma ka auwai me na Loni o Oahu a hiki i ka auwai Kamaui e pili ana me "Kamaui". Akau Kema 33° Kom. 161 Pautu, Kema 42° 30' Kom. 184 Pautu ma ka lili Kema o ka auwai Kamaui e pili ana me "Kamaui" a hiki i ka Kame, Akau Kema 45° Kikina 375 Pautu e pili ana me ka Kame a hiki i ka hoomaka ana.

Eia ka Ii 78/100 Eka.

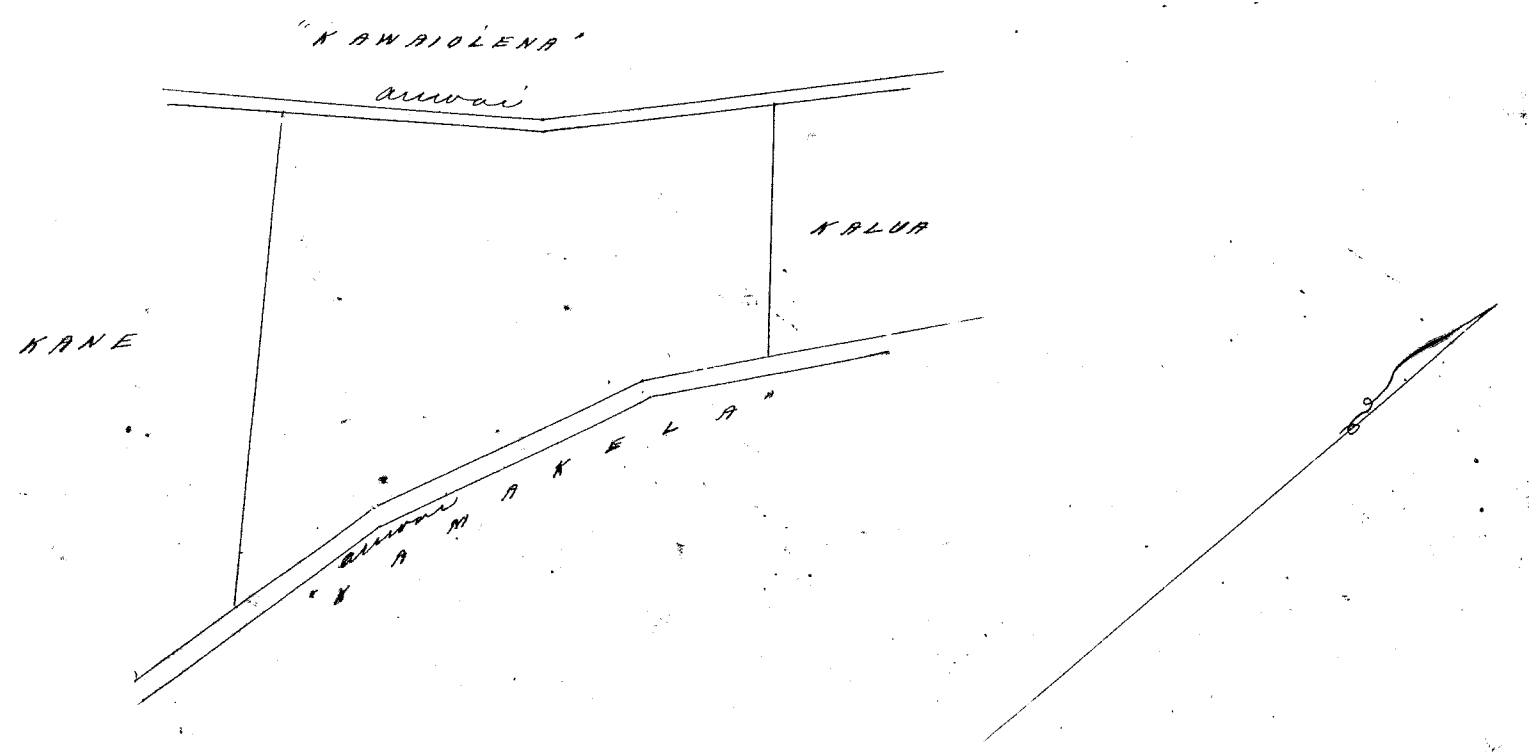

Heleu 8075 Kopu

Ua kōi mai oia no kona wahi ma Palikea i Nuuanu, i Honolulu, ma Kona, ma ka Moku-puni o Oahu; no ka mea, ua hoaa ia ia keia wahi no Kepu mai i ka wa e ola ana o Kinuw, a ua nōho keakea oleia a hiki i keia manawa.

Oia ka makou e hooho nei no Kopu; he kuleana hoi kona, malalo iho o ke Ano Alodis. Ina e uku mai oia i ke ke Aupuni kapaka; ataita, ua kōpuna ia ia ka Palapala Sila Alodis.

W. L. Lee
G. M. Robertson
J. Bekaulahau
J. H. Smith

Pono nae ia ia ke uku no ka hooholokolo ame ka hooholo ana i ka olelo, Penei; -
No ka nuni ame ke pōi ana i ka olelo ma ka Nupupa.
No ke kopu ana i ka olelo kona
No ka palapala kii
No ka huna ana i ka la 13, Mei 1857.
No ke kopu ana i ma olelo ana hoiho
No ke ana ana i ka la 7, Dekemaba 1853.
No ke kopu ana
No ka hooholo ana i ka olelo i ka la 12, December 1853.

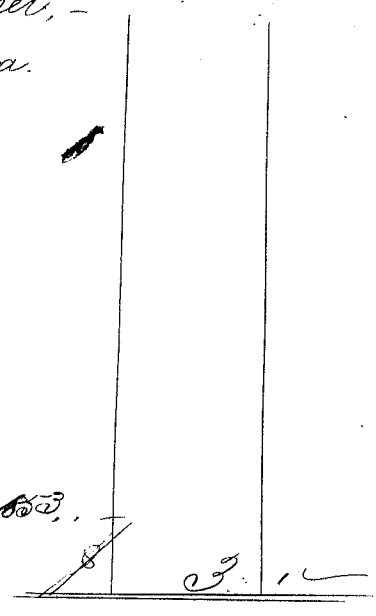

Eia ma palena. Anania e S. P. Kalamia.

Aina ma Palikea, Nuuanu, Honolulu, Oahu.

Loi me Katuakalo. E hoomaka ma ke kahi Komohana makai o keia aina, ma ka lihi mauka o ke Alanui Puumi kokoke i Kahawai, - A e hōlo Kona 50° Heikina 346 Pautu pili ana ma ka lihi mauka o ke Alanui Puumi a hiki i ka Apana aina o Lima no ke Aupuni, - Ataita Akau 33° Heikina 181 Pautu pili ana me Aupuni ame Katula, a neenee kōpuna Lima Akau 10 Pautu pili me Katula a hiki i ke kahi Komohana makai o ka aina o Kinimaka, - Ataita Akau 22° 15' Heikina 121 Pautu pili me Kinimaka, - Ataita Akau 56° 15' Kona 203 Pautu pili me Kinimaka ame Kaohana a hiki i Kahawai, - Ataita iho i ka ma Kahawai a hiki i ka hoomaka ana.

Eia ka Ili 58/100 Eka.

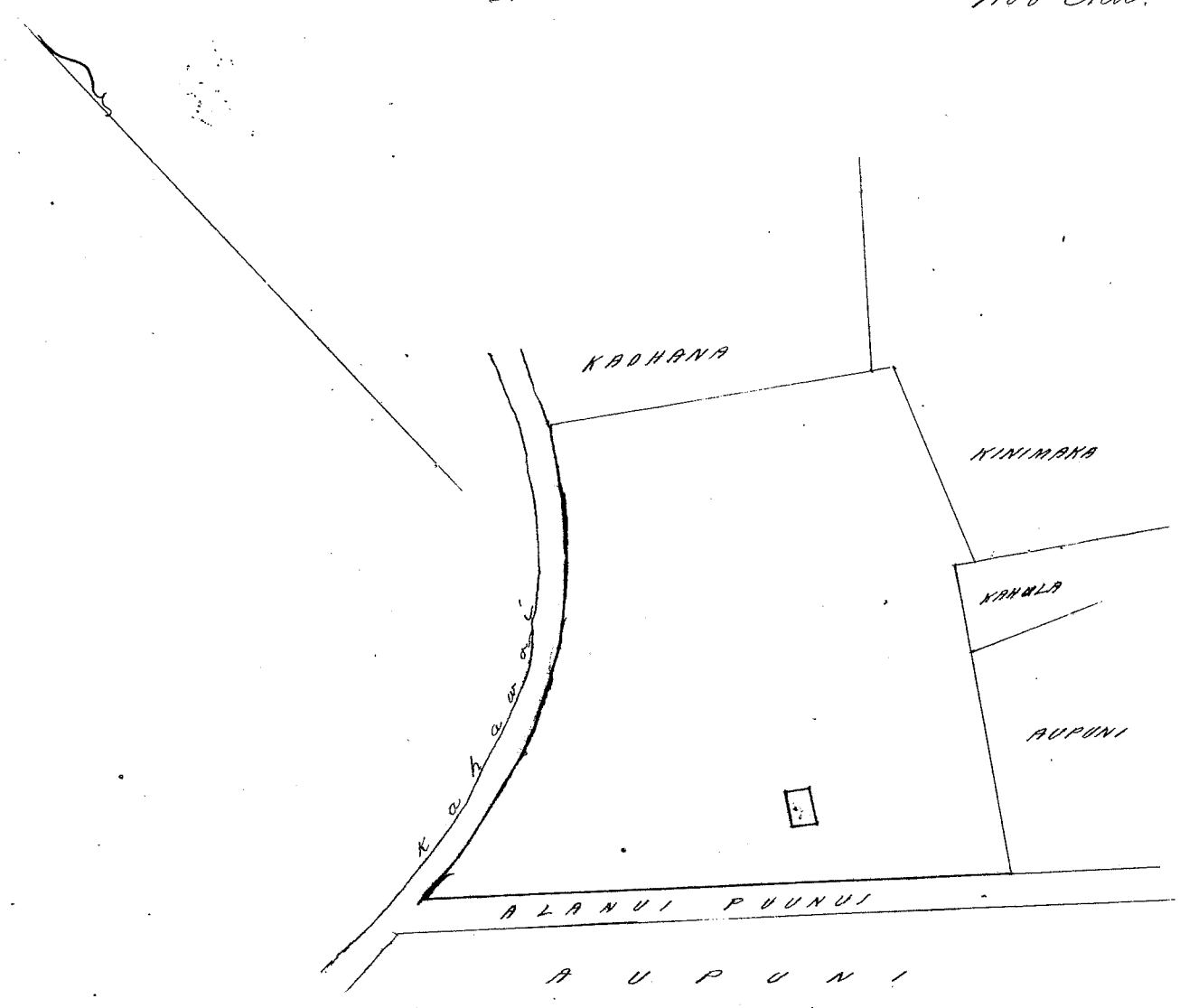

Heleu 5743 Kapahi

Ua kōi mai oia no kona wahi ma Palikea, Nuuanu, Honolulu, Oahu ma Kona, ma ka Moku-puni o Oahu; no ka mea, ua hoaa ia ia keia wahi no Kepu mai i ka manawa o Kinuw e ola ana, a ua nōho keakea oleia a hiki i keia manawa.

Oia ka makou e hooho nei no Kapahi; he kuleana hoi kona malalo iho o ke Ano Alodis. Ina e uku mai oia i ke ke Aupuni kapaka; ataita, ua kōpuna ia ia ka Palapala Sila Alodis.

Pono nae ia ia ke uku no ka hooholokolo ame ka hooholo ana i ka olelo. Penei; -

W. L. Lee
 G. M. Robertson
 J. Kekaulaha
 J. H. Smith

No ka rumi ame ke pui ana i ka olelo ma ka Mufupa.
 No ke kope ana i ka olelo koma
 No ka palapala kei
 No ka hana ana i ka law 14 o October 1851.
 No ke kope ana i na olelo a na hioke
 No ke ana ana i ka law 7 o Dekemaba 1853.
 No ke kope ana
 No ka hooholo ana i ka olelo i ka law 12 o December 1853.

3

Eia na palina. Anai e S. P. Kalama.

Aina ma Palikea, Niuanu, Honolulu, Oahu.

4 Loi me Kulmahale. E hoomaka ma ke kiki Heema o keia aina, i pili ana me ke Alanui Hale Pule ana ke Kaihaha. E holo ana Akau 25° Kom. 150 Panku pili me Kaihaha me Kefu. Alaila Akau 14° Kom. 165 Panku pili me Molina. Alaila Akau 72° 30' Kikina 15 Panku pili me Kaiapapa. Alaila Heema 88° Kikina 79 Panku. Akau 9° 30' Kom. 88 Panku pili me Molina. Alaila Heema 70° 15' Kikina 191 Panku pili me Dr. Rooke. Alaila Heema 45° Kikina 81 Panku me Kaimihau. Alaila Heema 36° Kom. 284 Panku. Heema 61° Kom. 81 Panku pili me ke Alanui Hale Pule a hiki i ka hoomaka ana.
 Eia ka Ii 74/100 Eka.

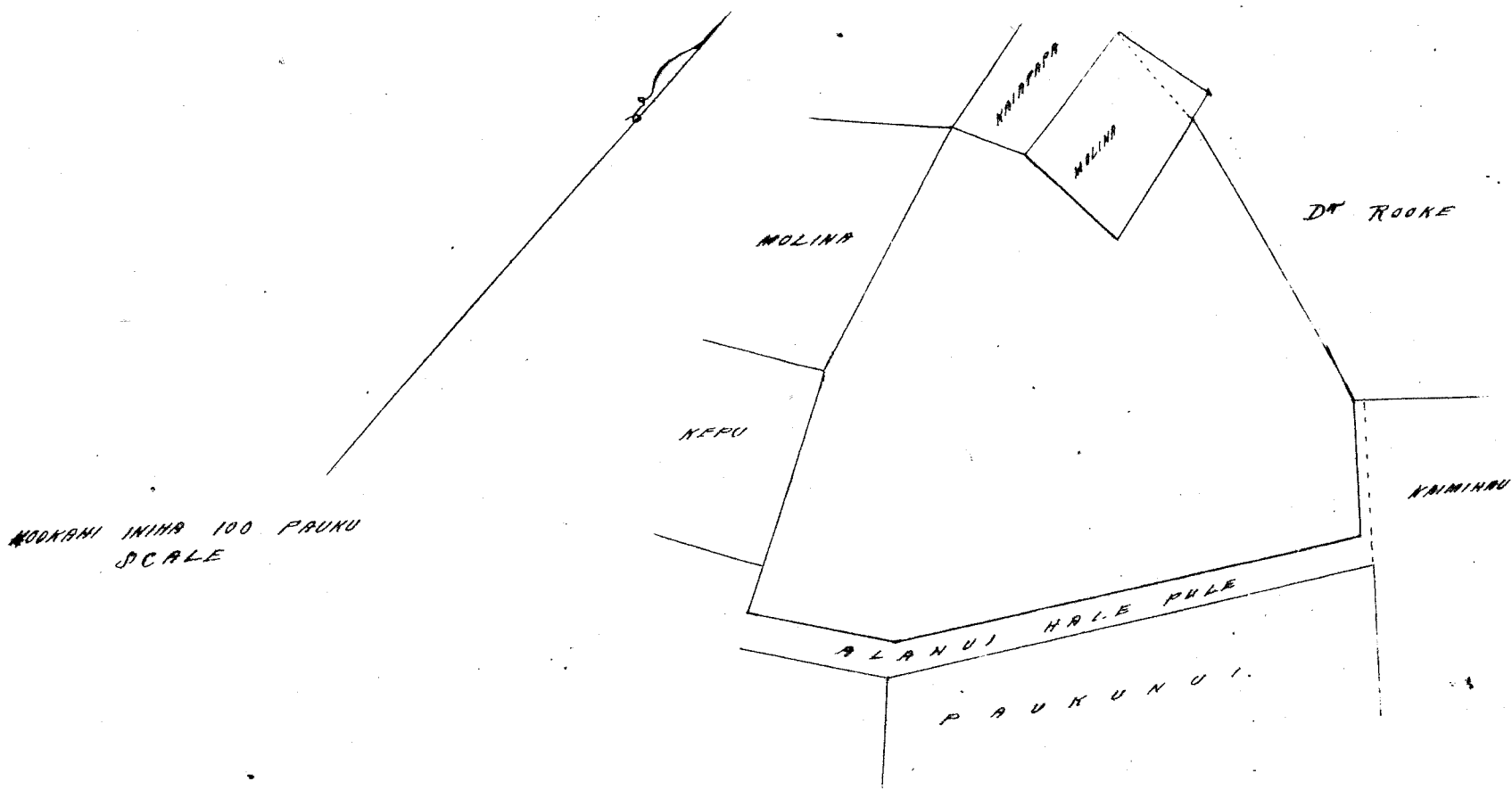

Helu 5578 Kapuaipoo

Ua koi mai oia no kona Ahupuaa o "Pelekuni" ma Koolau, ma ka Moku o Oahu; no ka mea, ua loaa ia ia keia aina no ka Mui Kamehameha III mai i ka mahele ana i ka M. H. 1848, a ua noho kaakea oia a hiki i keia manawa.

Oia ka makou e hooke nei no Kapuaipoo, ke kuleana hoikona malalo iho o ke Ana Alodio. Ina e uku mai oia iho ke Aupeuni hapaha; alaila, ua kupono ia ia ka Palapala Lilo Alodio. Aka, koema na kuleana o ma kaanaka maloko.

Pono navi ia ke uku no ka hooholo ana i ka olelo. Penei.

No ka rumi ame ke pui ana i ka olelo ma ka Mufupa
 No ke kope ana i ka olelo koma
 No ka palapala kei
 No ka hana ana i ka law
 No ke kope ana i na olelo a na hioke
 No ke ana ana i ka law
 No ke kope ana
 No ka hooholo ana i ka olelo i ka law 13 o December 1853.

G. M. Robertson
 J. Kekaulaha
 J. H. Smith

Anaia i Toba Kahema

Olelo hoakaka i ke anaia i ke Anupuaa o Pelekunio ma Molokai.

Stawuolepu	He	Hi	Ke	Ma	Ma	Ma
	65	7.22	Kaulakuo	fulu	mo	Stawuolepu
	58 3/4	10.84	"	"	"	"
	4	18.24	"	"	"	Kanipuaakala
	11 3/4	15.97	"	"	"	Kilou
	14	9.00	"	"	"	"
	16 1/2	10.13	"	"	"	Keriamiki
	7 1/2	6.16	"	"	"	"
	71	56.40	"	"	"	"
	9 1/2	77.32	"	"	"	Kuahiwi
A	54 1/2	69.00	"	"	"	Tapakea
A	21 1/4	9.50	"	"	"	"
He	13 3/4	149.68	"	"	"	"
He	0 1/4	57.30	"	"	"	"
A	81 1/2	121.12	"	"	"	Kuahiwi
A	21 1/2	52.48	"	"	"	" o Kaituu
A	17	101.80	"	"	"	"
A	77 1/2	112.40	"	"	"	"
A	58 3/4	127.60	"	"	"	"
A	41 1/2	98.32	"	"	"	"
A	24 1/2	25.60	"	"	"	"
A	34 3/4	23.52	"	"	"	Pali
He	21 3/4	37.28	"	"	"	Kai
He	87 1/2	14.18	"	"	"	"
A	23 3/4	34.23	"	"	"	"
He	65 1/4	18.08	"	"	"	Pali
He	81 3/4	151.60	"	"	"	Kui
He	19 1/2	50.52	"	"	"	Kaitolu
He	69 1/2	144.00	"	"	"	Kuahiwi
A	46	83.80	"	"	"	Kawaoolepu

a hiki i ka hoemaka ana

O kona Hi 5345 Eka

Septemaba 13, 1853.

Toba Kahema
Moa Anaia

Olelo hoakaka. Aole i kopua ke kii o keia ana iloko o keia Buku mo kaunui loa, nolaila, ua kopua ma ke ana ana wale no. — E nana i ke kii ma ka pepa ana a Toba Kahema.

December 13, 1853.

J. L. Kailiili
Moa Kakaulelo

Books vol. 2.

Helu 7152. Kiniakua

Ua koi mai oia ma kona wahi ma Anupuaa i Honolulu, mo Kona, ma ka Moku oia o Oahu, no ka mea, ua loa ia i keia wahi mo Adama Kaiwi oia ma kona ana i ka M. H. 1847, a ua noho keia olelo a hiki i keia manawa.

Oia ka ma ka e hoohe meina Kiniakua, he kuleana hoi kama malalo iho o ke Ana Alodia. Ina e ukia mai oia i keia Anupuaa hapaha; akeia, ma kupaia ia ia ka Palapala Lita Alodia.

Pono nui ia ia ke ukia no ka hoohelele oia ma keia olelo. Penei —

- W. L. Lee No ka rumi ame ke pua ana i ka olelo ma ka Mapepa.
- G. M. Robertson No ke kopu ana i ka olelo koina
- J. Heaulaha No ka palapala kii
- D. H. Smith No ka hana ana i ka la

No ke kope ana i na olelo a nahi ike
No ke ana ana i ka la
No ke kope ana
No ke hoo holo ana i ka olelo i ka la 14 o December 1853.

Eia na palena. Anania e S. P. Kalamua.

Aina ma Niupaiapai, Honolulu, Kona, Oahu.

8 Loi. E hoomaka ma ke kiki Mea ma Kahawai, - E holo ana Kema 26 Hikiina 165 Panku,
Kema 54 Hikiina 78 Panku pili me Kunkuu, - Alaila Kema 45 Kom. 55 Panku, Kema 1 Hikiina 148
Panku, - Kema 71 Hikiina 23 Panku, - Kema 45 30 Hikiina 71 Panku ame Kema 45 30 Kom. 53 Panku
pili me Nihonui, - Alaila Kema 25 30 Kom. 74 Panku, - Kema 10 Hikiina 108 Panku pili me Kahopuu,
Alaila Komohana 51 Panku, Mea 48 Kom. 37 Panku pili me Nini Ili no Nohu, - Alaila Mea 3/4 Degere
Hikiina 46 Panku, - Mea 32 Hikiina 44 Panku, - Mea 2 30 Kom. 90 Panku, Mea 83 30 Kom. 47 Panku, - Mea
3 15 Hikiina 87 Panku, - Mea 8 Hikiina 154 Panku, Mea 77 30 Kom. 137 Panku pili me Kuuwi a hiki i
Kahawai, - Malaila aku ma Kahawai a hiki i ka hoomaka ana

Ma Ili 72/100 Eka.

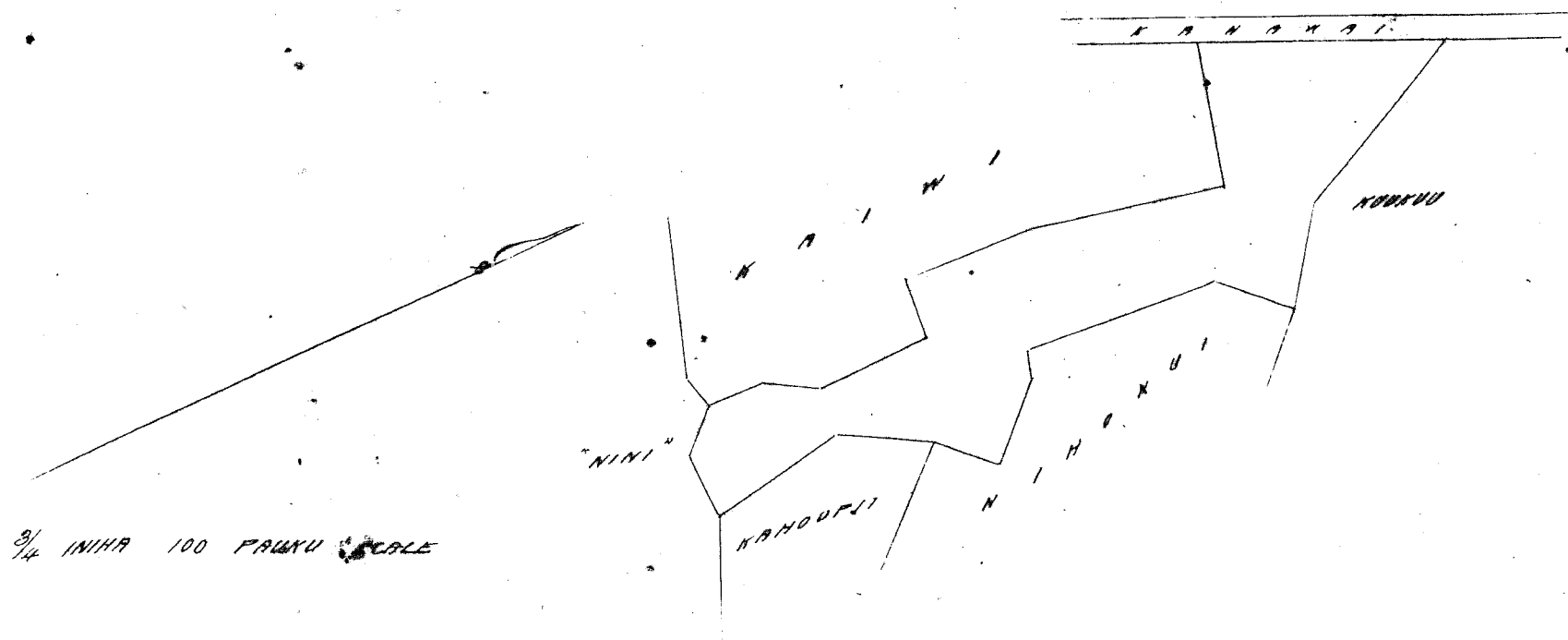

Plot 5046 B Kaewai (no D. Kalauiwa)

Ma kei mai oia no kona wahi ma Auwailimu i Honolulu, ma Kona, ma kei Mahele
ni o Oahu, no ka mea, ua loa ia ia ka wahi no Aikanaka mai i ka wa o Kuahumanui e ola ana, aua
noho keakea ole a hiki i keia manawa.

Oia ka makou e hooke nei no Kaewai a ia Kalauiwa kana keiki, ke kuleana hoi kona malala,
iho o ke Ano Alodis. Ana e uau mai oia i ke ke Auwailimu hapu, alaila, ua kupa ia ia ka Palapala o ke Ano Alodis.

Poru nae ia ia ke uku no ka hoo holo ana i ka olelo i ka la 7 o Feberuari 1853.

W. L. Lee
G. M. Robertson
S. Kekaulaha
J. H. Smith

No ke rumi ame ke pui ana i ka olelo ma kei Niupai.
No ke kope ana i ka olelo koia
No ka palapala kii
No ka hana ana i ka la 7 o Feberuari 1853.
No ke kope ana i na olelo a nahi i ke 1/3 Awa
No ke ana ana i ka la 13 o Dekemaba 1853.
No ke kope ana
No ke hoo holo ana i ka olelo i ka la 14 o December 1853.

Eia na palena. Anania e S. P. Kalamua.

Aina ma Auwailimu, Honolulu, Kona, Oahu.

7 Loi. E hoomaka ma ke kiki Hikiina ma kei aia e pili ana me ke kiki
Komohana o ke Alanui Nuuanu, E holo aku i ka Kema 32 Kom. 49 Panku me ke kiki Alanui
Nuuanu, - Alaila Mea 45 15 Kom. 145 Panku, - Kema 44 Kom. 137 Panku pili ana me ke ana

o Kulu, Alaila Akau 46° Kom. 37 Panku, Heema 46° 30' Kom. 113 Panku pili ana me Malihini, Alaila Akau 42° 30' Kom. 139 Panku pili me ka aiaa o Kukona ia J. H. Wood ame iuku waiho wale no L. Kaula a hiki i ka palena o Kaunahoula, Alaila Akau 47° Hikina 53 Panku pili me Kaunahoula, Alaila Heema 43° Hikina 84 Panku, Akau 45° Hikina 52 Panku, Akau 37° Kom. 18 Panku, Akau 44° Hikina 66 Panku, ame Akau 48° Hikina 137 Panku pili me Kammakini a hiki i ke kahi o ka aiaa o J. H. Wood, Alaila Heema 41° Hikina 233 Panku pili me ka aiaa o J. H. Wood a hiki i ka hoomaka ana.

Eia ka Ili

1 Ruda 22 Rota

S. P. Kalamia

Ana Ana

[Signature]

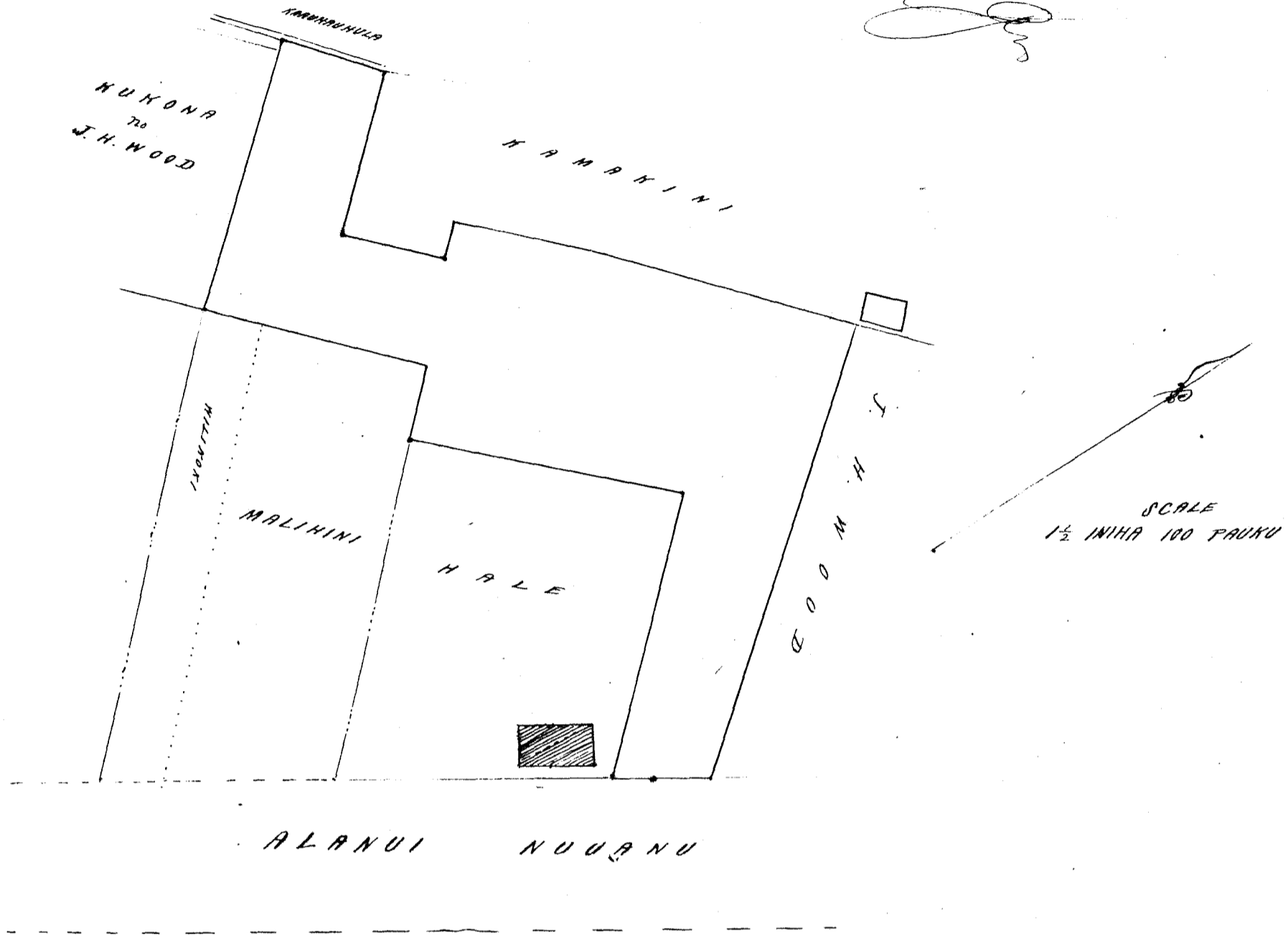

Kulu 10 182 ⁶⁶⁶⁰ Molina

Ua hoi mai oia no kona wahi ma Palikea, Nuuanu, Honolulu, Oahu, ma ka Mokupuni o Oahu, no ka mea, ua loaa i ia wahi no Kepu mai mamua oia o ka (M. H. 1839), a ua noho keakea oia a hiki i keia manawa.

Oia ka makou e hooke nei no Molina, ke kuli ana hoi kona matala iho o ke Aro Alodio. Ina iuku mai oia i ke ke Aupuni kupaia, alaila, ua kupaia ia ia ka Palapala Sila Alodio.

Pono nuiwaria ke iku no ka hooke oloko ame ka hooke ana i ka olelo. Penei: -

- W. L. Lee
- M. Robertson
- J. Kakaiaha
- J. H. Smith

- No ka rumi ame ke pua i ma i ka olelo ma ka Niuepa
- No ke kope ana i ma olelo koina
- No ka palapala kii
- No ka hana ana i ka la 30 o Iulai 1851
- No ke kope ana i ma olelo a waiho ke 1/4 Awa
- No ke ana ana i ka la 7 o Decemaba 1853.
- No ke kope ana
- No ka hooke ana i ka olelo i ka la 14 o Decemaba 1853.

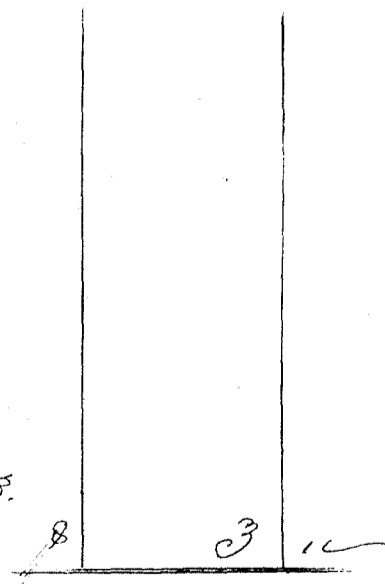

Eia ma palena. Anaia e S. P. Kalamia.

Aino ma Palikea, Nuuanu, Honolulu, Oahu,

Apana 1. 1 Loi. E hoomaka ma ke kahi Heema o keia Ili, e pili ana me Kapahi ame Aupuni, a hiki i ka palena o Kaunahoula, Alaila Akau 82° Hikina 67 Panku, ame Heema 9° 30' Hikina 113 Panku pili me Dr. Cooke ame Kapahi, Alaila Akau 88° Kom. 77 Panku pili me Kapahi a hiki i ka hoomaka ana.

Ka Ili

7 1/2 / 100 Eka.

Apana 2. 6 Lōi me Kāmāhale. E hōmaka ma kekahi Akau ma Kahawai, E holo ana Kema 88' Hikina 164 Pūku pili me Piawa, - Akau 67' Hikina 140 Pūku pili me Piawa me Holoua, - Kema 14' Hikina 165 Pūku pili me Kūpahi, - Kema 77' Kom. 150 Pūku pili me Kēpu, Holoua me Kūaha, - Akau 84' 30' Kom. 153 Pūku pili me Kūaha, Kema 7' Hikina 155 Pūku pili me Kūaha, Kema 22' Hikina 79 Pūku pili me Holoua, Kema 54' 45' Hikina 87 Pūku, - Kema 29' Kom. 97 Pūku pili me Lahaia, - Alaila Akau 43' Kom. 125 Pūku pili me Lahaia me Kahawai, Akau 57' Kom. 76 Pūku, Akau 22' Kom. 54 Pūku me maloua akau ma Kahawai a hiki i ka hōmaka ana

Ka Ili $\frac{88}{100}$ Eka. = Eia ka Ili apana $\frac{95}{100}$ Eka.
 I Kalama
 ana Aina

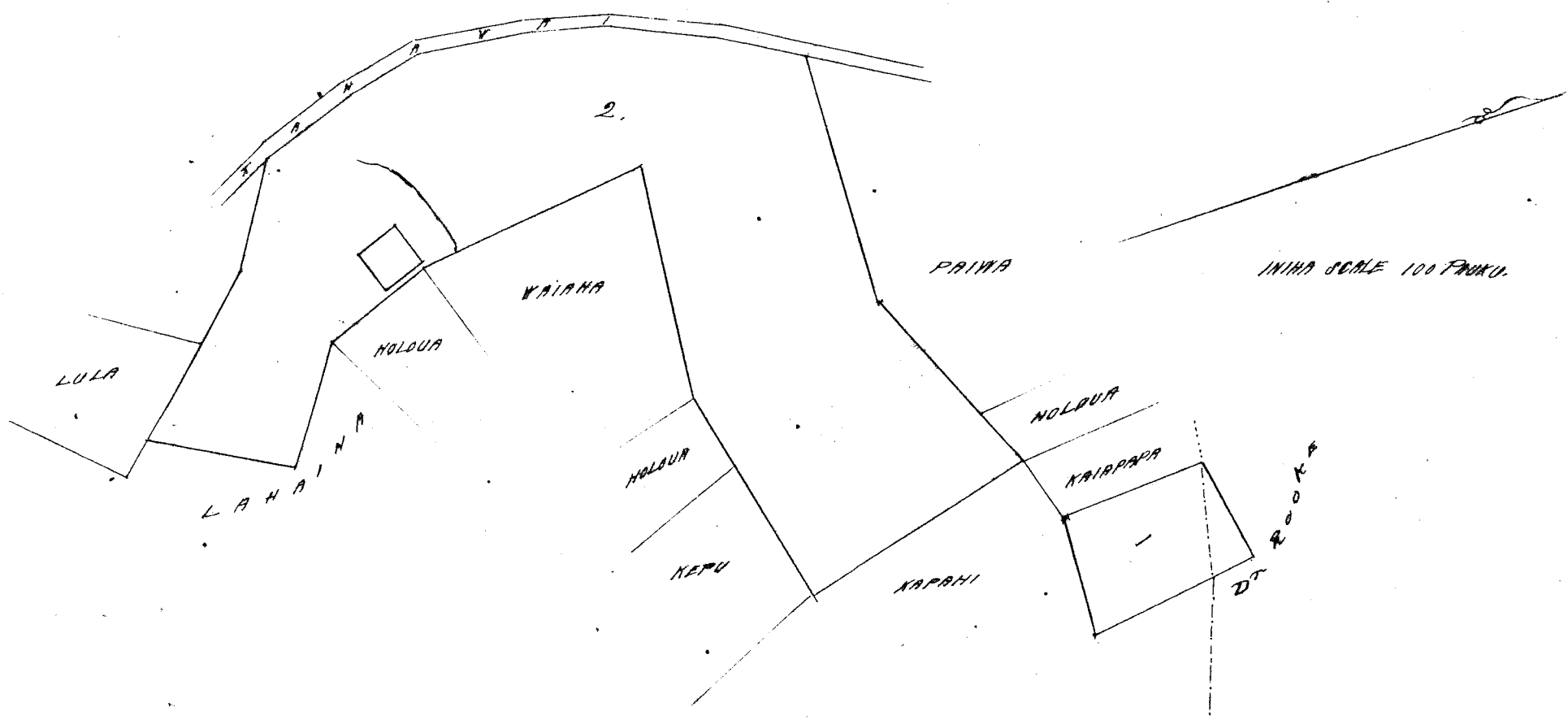

Hulu 10613 A. Paki Part 2.

Ua hōi mai oia no kona Ahupuaa o Puunani ma Lahaia, ma ka Moku o Apana, no ka mea, ua hōia iā ia he māu wahi no ka Mōi Kamehameha III mai i ka mahalo aia iā ia i ka M. H. 1848, aua moho kiuea oia a hiki i ka māu wahi.

Oia ka māu 2 hōke mai no A. Paki, he kuleana hōi kona malalo iho o ke Aho Aloha. Iuana nuku mai oia i ke Aupuni hupaha, alaila, ua kōpuna ia i ka Palapala o ke Aho Aloha. Aka, hōe nā māu kuleana ma kamahele maloko.

- Pono nāe iā ia ke nuku no ka hōkōloko a me ka hōhōlo ana i ka olelo. Penei -
- W. L. Lee No ka nūmi a me ke pūi ana i ka olelo ma ka Kūpepa.
 - G. M. Robertson No ke kōpe ana i ka olelo kōina
 - A. Kaulahao No ka palapala kii
 - J. H. Smith No ka hānu ana i ka la
 - No ke kōpe ana i na olelo a ma hōi
 - No ke ana ana i ka la
 - No ke kōpe ana
 - No ka hōhōlo ana i ka olelo i ka la 14. December 1853.

Eia ma palena. Anaiia i H. P. Alexander

He olelo hōkōloko i ke ana ana i ke Ahupuaa o "Puunani" no A. Paki, e waiho ana ma Lahaia, Apana.

E hōmaka ana ma kahakai ma ke kihi Akau Kōmohano, a e holo ana

A	52°	Hi	2.06	Kaulahao e pili ana me Puunani, Kēpu
A	61°	Hi	2.92	"
A	56°	Hi	1.97	"
A	49½	Hi	2.11	"
A	62°	Hi	4.63	"
A	61°	Hi	7.49	"
A	60°	Hi	1.41	"

A	66°	Hi	2.66	Kaulakao, e fili ana me Puumau o Kapu
A	85 1/2°	Hi	12.37	"
He	29°	Hi	0.98	"
He	67°	Ko	3.98	"
He	82 1/4°	Ko	6.00	"
A	43°	Ko	0.67	"
He	77°	Ko	3.63	"
He	3 3/4°	Hi	2.47	"
He	73 1/2°	Ko	6.33	"
He	10 1/4°	Hi	1.43	"
He	59°	Ko	5.33	"
He	67 1/2°	Ko	3.00	"
He	58 1/2°	Ko	1.15	"
He	76°	Ko	1.28	"
He	51 1/4°	Ko	2.71	"
A	33°	Ko	2.19	"

Oka Ali

Kakakai a hiki aku i kahi i hoomaka ai -
Emau Eka.

Apuna 2. Oka Apuna kato ia e waiho la mauka, ma Kaulakao, -
E hoomaka ana ma ke kahi Keaw Komohana, ma ka huina o Kooka ama Pukuehu, a e holo ana

He	21°	Hi	0.80	Kaulakao e fili ana me Pukuehu
He	5 1/4°	Hi	1.23	"
He	43°	Hi	0.56	" a hiki i lalo i ke kauhauai
He	84 1/2°	Hi	5.69	" Kauhauai o Kaulakao
A	75°	Hi	3.11	"
A	46°	Hi	3.23	"
A	24 1/4°	Ko	3.35	"
A	41 1/2°	Hi	2.39	" Puumau o Kapu iluna o ka pali
A	56 3/4°	Ko	1.31	"
A	42°	Ko	1.91	" Kauhauai
He	60 1/4°	Ko	6.86	"
Ko	51 1/4°	Ko	3.14	" Kooka a hiki i kela kapu o ke awa
He	69 1/2°	Ko	1.04	"

Oka Ali

E hiki ana Eka
N. P. Alexander
Mea ana ana.

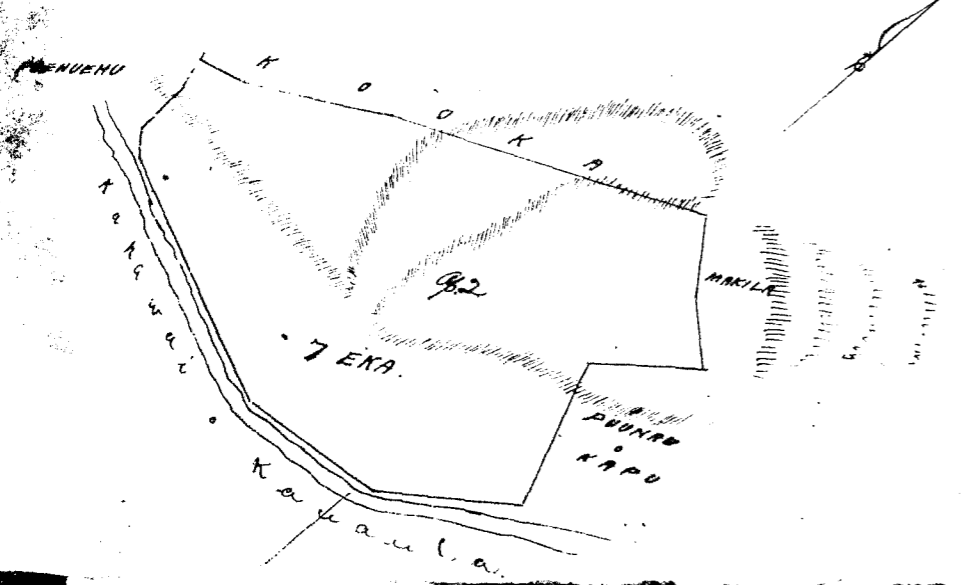
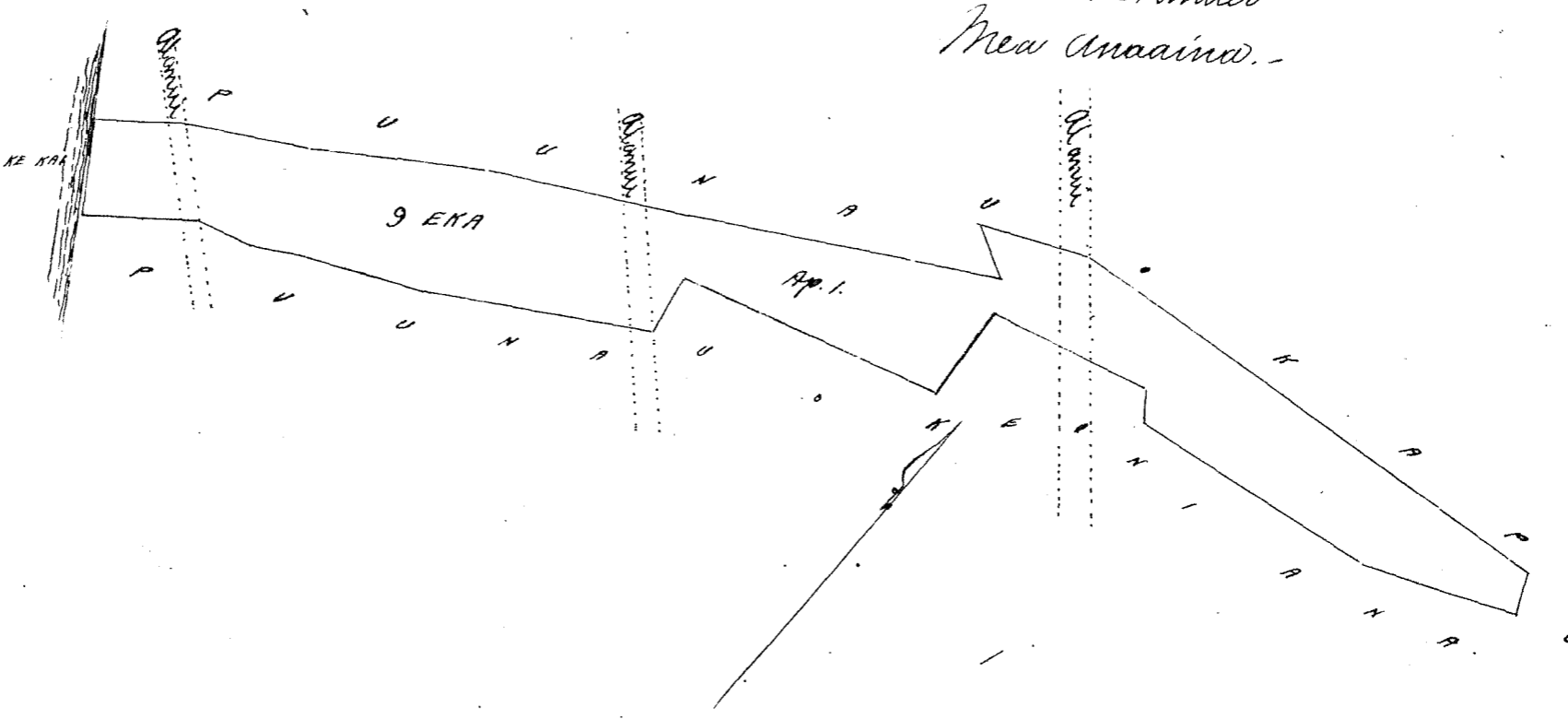

Ap. 1. 4 Kaulakao - 11111
" 2. 4 " "